

TPS7A20C 300mA, Low-Noise, Fast-Settling LDO

1 Features

- Fast settling when used with low output capacitance and inductance
- Low output voltage noise: $7\mu\text{V}_{\text{RMS}}$
 - No noise-bypass capacitor required
- High PSRR: 58dB at 100kHz, 20mA
- Very low I_{Q} : 11 μA
- Input voltage range: 1.6V to 6.0V
- Output voltage range: 0.8V to 5.5V
- Output voltage tolerance: $\pm 1.5\%$ (max)
- Very low dropout:
 - 140mV (max) at 300mA ($V_{\text{OUT}} = 3.3\text{V}$)
- Low inrush current
- Smart enable pulldown
- Stable with 0.47 μF minimum output capacitance
- Package:
 - 0.616mm \times 0.616mm DSBGA

2 Applications

- [Image sensors](#)
- [Smartphones](#) and [tablets](#)
- [IP network cameras](#)
- [Portable medical equipment](#)
- [Smart meters](#) and [field transmitters](#)
- [Motor drives](#)
- [Wearables](#)

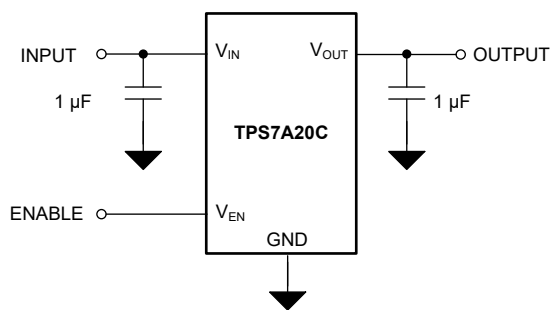

Simplified Application Schematic

3 Description

The TPS7A20C is an ultra-small, low-dropout (LDO) linear regulator that sources 300mA of output current. This LDO is designed to power sensitive loads such as image sensors. When used with low output capacitance and inductance, the device provides low noise, high PSRR, and excellent load and line transient performance. Using innovative design techniques, the TPS7A20C offers ultra-low noise performance without the addition of a noise-bypass capacitor. The TPS7A20C also provides the advantage of low quiescent current, which is useful in battery-powered applications. The 1.6V to 6.0V input voltage range and 0.8V to 5.5V output range are appropriate for a wide variety of applications. The device uses a precision reference circuit to provide a maximum accuracy of 1.5% over load, line, and temperature variations.

The TPS7A20C features an internal soft-start circuit to lower the inrush current, thus minimizing the input voltage drop during start-up. The device is stable with small ceramic capacitors, allowing for a small overall solution size.

The TPS7A20C has a smart enable input circuit with an internally controlled pulldown resistor. This resistor keeps the LDO disabled and helps eliminate the external components used to pulldown the EN pin. The LDO remains disabled even when the EN pin is left floating.

Package Information

PART NUMBER	PACKAGE ⁽¹⁾	PACKAGE SIZE ⁽²⁾
TPS7A20C	YCK (DSBGA, 4)	0.616mm \times 0.616mm

- (1) For more information, see the [Mechanical, Packaging, and Orderable Information](#).
- (2) The package size (length \times width) is a nominal value and includes pins, where applicable.



Table of Contents

1 Features	1	7 Application and Implementation	18
2 Applications	1	7.1 Application Information.....	18
3 Description	1	7.2 Typical Application.....	22
4 Pin Configuration and Functions	3	7.3 Power Supply Recommendations.....	23
5 Specifications	4	7.4 Layout.....	23
5.1 Absolute Maximum Ratings.....	4	8 Device and Documentation Support	24
5.2 ESD Ratings.....	4	8.1 Device Support.....	24
5.3 Recommended Operating Conditions.....	4	8.2 Receiving Notification of Documentation Updates.....	24
5.4 Thermal Information.....	5	8.3 Support Resources.....	24
5.5 Electrical Characteristics.....	5	8.4 Trademarks.....	24
5.6 Switching Characteristics.....	6	8.5 Electrostatic Discharge Caution.....	24
5.7 Typical Characteristics.....	7	8.6 Glossary.....	24
6 Detailed Description	14	9 Revision History	24
6.1 Overview.....	14	10 Mechanical, Packaging, and Orderable Information	24
6.2 Functional Block Diagram.....	14	10.1 Mechanical Data.....	25
6.3 Feature Description.....	15		
6.4 Device Functional Modes.....	17		

4 Pin Configuration and Functions

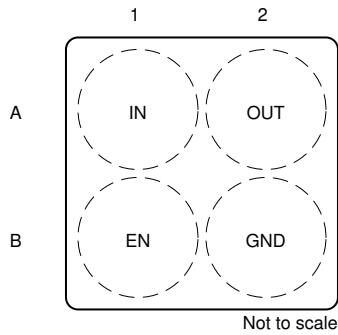

Figure 4-1. YCK Package, 4-Pin DSBGA (Top View)

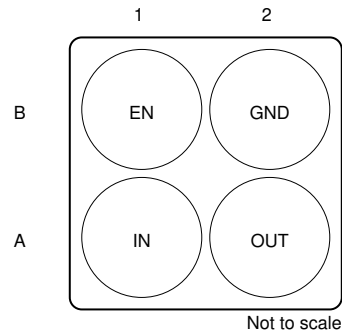

Figure 4-2. YCK Package, 4-Pin DSBGA (Bottom View)

Pin Functions: DSBGA

PIN		I/O	DESCRIPTION
NO.	NAME		
A1	IN	I	Input voltage supply. For best transient response and to minimize input impedance, use the nominal value or larger capacitor from IN to ground. See the Recommended Operating Conditions table. Place the input capacitor as close to the IN and GND pins of the device as possible.
A2	OUT	O	Regulated output voltage. A low equivalent series resistance (ESR) capacitor is required from OUT to ground for stability. For best transient response, see the Input and Output Capacitor Requirements section. Place the output capacitor as close to the OUT and GND pins of the device as possible.
B1	EN	I	Enable input. A low voltage ($< V_{EN(Low)}$) on this input turns the regulator off and discharges the output pin to GND. A high voltage ($> V_{EN(HI)}$) on this pin enables the regulator output. This pin has an internal 500k Ω pulldown resistor to hold the regulator off by default. When $V_{EN} > V_{EN(HI)}$, the 500k Ω pulldown is disconnected to reduce input current.
B2	GND	—	Common ground.

5 Specifications

5.1 Absolute Maximum Ratings

over operating free-air temperature range (unless otherwise noted)⁽¹⁾ ⁽³⁾

		MIN	MAX	UNIT
Voltage	V _{IN}	-0.3	6.5	V
	V _{OUT}	-0.3	6.5 or V _{IN} + 0.3 ⁽²⁾	
	V _{EN}	-0.3	6.5	
Current	Maximum output ⁽⁴⁾	Internally limited		A
Temperature	Operating junction, T _J	-40	150	°C
	Storage, T _{stg}	-65	150	

- (1) Stresses beyond those listed under *Absolute Maximum Ratings* may cause permanent damage to the device. These are stress ratings only, and functional operation of the device at these or any other conditions beyond those indicated under Recommended Operating Conditions is not implied. Exposure to absolute-maximum-rated conditions for extended periods may affect device reliability.
- (2) The maximum value of V_{OUT} is the lesser of 6.5V or (V_{IN} + 0.3V).
- (3) All voltages are with respect to the GND pin.
- (4) Internal thermal shutdown circuitry protects the device from permanent damage.

5.2 ESD Ratings

			VALUE	UNIT
V _(ESD)	Electrostatic discharge	Human-body model (HBM), per ANSI/ESDA/JEDEC JS-001 ⁽¹⁾	±2000	V
		Charged-device model (CDM), per JEDEC specification JESD22-C101 ⁽²⁾	±750	

- (1) JEDEC document JEP155 states that 500V HBM allows safemanufacturing with a standard ESD control process.
- (2) JEDEC document JEP157 states that 250V CDM allows safemanufacturing with a standard ESD control process.

5.3 Recommended Operating Conditions

over operating free-air temperature range (unless otherwise noted)⁽¹⁾

		MIN	NOM	MAX	UNIT
V _{IN}	Input supply voltage	1.6		6.0	V
V _{EN}	Enable input voltage	0		6.0	V
V _{OUT}	Nominal output voltage range	0.8		5.5	V
I _{OUT}	Output current	0		300	mA
C _{IN}	Input capacitor ⁽²⁾		1		μF
C _{OUT}	Output capacitance ⁽³⁾	0.47		10	μF
ESR	Output capacitor effective series resistance			50	mΩ
T _J	Operating junction temperature	-40		125	°C

- (1) All voltages are with respect to GND.
- (2) An input capacitor is not required for LDO stability. However, an input capacitor with an effective value of 0.47μF minimum is recommended to counteract the effect of source resistance and inductance, which may in some cases cause symptoms of system-level instability such as ringing or oscillation, especially in the presence of load transients. Using an input capacitor at least equal to the output capacitor is generally good practice.
- (3) To help achieve fast settling and avoid instability, the output capacitance (including tolerance, bias voltage, temperature variations, etc.) should fall within the specified range.

5.4 Thermal Information

THERMAL METRIC ⁽¹⁾		TPS7A20C	UNIT
		YCK (DSBGA)	
		4 PINS	
R _{θJA}	Junction-to-ambient thermal resistance	201.4	°C/W
R _{θJC(top)}	Junction-to-case (top) thermal resistance	2.8	°C/W
R _{θJB}	Junction-to-board thermal resistance	69.3	°C/W
ψ _{JT}	Junction-to-top characterization parameter	1.4	°C/W
ψ _{JB}	Junction-to-board characterization parameter	69.2	°C/W
R _{θJC(bot)}	Junction-to-case (bottom) thermal resistance	N/A	°C/W

(1) For more information about traditional and new thermal metrics, see the [Semiconductor and IC Package Thermal Metrics](#) application note.

5.5 Electrical Characteristics

at operating temperature range (T_J = –40°C to +125°C), V_{IN} = V_{OUT(NOM)} + 0.3V or 1.6V, whichever is greater, V_{EN} = 1.0 V, I_{OUT} = 1mA, C_{IN} = 1μF, C_{OUT} = 0.75μF derated (unless otherwise noted); all typical values are at T_J = 25°C

PARAMETER		TEST CONDITIONS		MIN	TYP	MAX	UNIT
ΔV _{OUT}	Output voltage tolerance	V _{IN} = (V _{OUT(NOM)} + 0.3V) to 6.0V, I _{OUT} = 1mA to 300mA, V _{OUT} ≥ 1.85V		–1.5		1.5	%
		V _{IN} = (V _{OUT(NOM)} + 0.3V) to 6.0V, I _{OUT} = 1mA to 300mA, V _{OUT} < 1.85V		–30		30	mV
ΔV _{OUT}	Line regulation	V _{IN} = (V _{OUT(NOM)} + 0.3V) to 6.0V, I _{OUT} = 1mA			0.03		%/V
ΔV _{OUT}	Load regulation	I _{OUT} = 1mA to 300mA			11		mV
I _{GND}	Quiescent ground current	V _{EN} = V _{IN} = 6V, I _{OUT} = 0mA	T _J = –40°C to 125°C			18.5	μA
		V _{EN} = V _{IN} = 6V, I _{OUT} = 300mA			2000		
I _{SHDN}	Shutdown ground current	V _{EN} = 0V (disabled), V _{IN} = 6.0V, T _J = –40°C to 125°C				5	μA
I _{GND(DO)}	I _{GND} in dropout	V _{IN} ≤ V _{OUT(NOM)} , I _{OUT} = 0mA, V _{EN} = V _{IN}			11	18	μA
V _{DO}	Dropout voltage	I _{OUT} = 300mA, V _{OUT} = 95% × V _{OUT(NOM)}	0.8V ≤ V _{OUT} < 1.0V ⁽¹⁾			690	mV
			1.0V ≤ V _{OUT} < 1.2V ⁽¹⁾			490	
			1.2V ≤ V _{OUT} < 1.5V ⁽¹⁾			355	
			1.5V ≤ V _{OUT} < 2.5V			200	
			2.5V ≤ V _{OUT} < 3.3V			140	
			3.3V ≤ V _{OUT} ≤ 5.5V			130	
I _{CL}	Output current limit	V _{OUT} = 0.9 × V _{OUT(NOM)} , V _{IN} = V _{OUT(NOM)} + 0.5 V	V _{OUT} < 1.5V	360	520	800	mA
		V _{OUT} = 0.9 × V _{OUT(NOM)} , V _{IN} = V _{OUT(NOM)} + 0.3 V	V _{OUT} ≥ 1.5V	360	520	770	
I _{SC}	Short-circuit current limit	V _{OUT} = 0V			185		mA
PSRR	Power-supply rejection ratio	I _{OUT} = 20mA, V _{IN} = V _{OUT} + 1.0V	f = 100Hz		95	dB	
			f = 1kHz		95		
			f = 10kHz		75		
			f = 100kHz		58		
			f = 1MHz		36		
		I _{OUT} = 300mA, V _{IN} = V _{OUT} + 1.0V	f = 100Hz		65		
			f = 1kHz		70		
			f = 10kHz		75		
			f = 100kHz		61		
			f = 1MHz		40		

5.5 Electrical Characteristics (continued)

at operating temperature range ($T_J = -40^{\circ}\text{C}$ to $+125^{\circ}\text{C}$), $V_{IN} = V_{OUT(NOM)} + 0.3\text{V}$ or 1.6V , whichever is greater, $V_{EN} = 1.0\text{V}$, $I_{OUT} = 1\text{mA}$, $C_{IN} = 1\mu\text{F}$, $C_{OUT} = 0.75\mu\text{F}$ derated (unless otherwise noted); all typical values are at $T_J = 25^{\circ}\text{C}$

PARAMETER		TEST CONDITIONS		MIN	TYP	MAX	UNIT
V_N	Output noise voltage	BW = 10Hz to 100kHz, $V_{OUT} = 2.8\text{V}$	$I_{OUT} = 300\text{mA}$		7		μV_{RMS}
			$I_{OUT} = 1\text{mA}$		10		
R_{PULLDOWN}	Output automatic discharge pulldown resistance	$V_{EN} < V_{EN(\text{LOW})}$ (output disabled), $V_{IN} = 3.1\text{V}$, $V_{OUT(\text{nom})} = 2.85\text{V}$			285		Ω
T_{SD}	Thermal shutdown	T_J rising			165		$^{\circ}\text{C}$
		T_J falling			140		
$V_{\text{EN}(\text{LOW})}$	Low input threshold	$V_{IN} = 1.6\text{V}$ to 6.0V , V_{EN} falling until the output is disabled				0.3	V
$V_{\text{EN}(\text{HI})}$	High input threshold	$V_{IN} = 1.6\text{V}$ to 6.0V , V_{EN} rising until the output is enabled		0.9			V
V_{UVLO}	UVLO threshold	V_{IN} rising		1.11	1.35	1.59	V
		V_{IN} falling		1.05	1.3	1.55	
$V_{\text{UVLO}(\text{HYST})}$	UVLO hysteresis				42		mV
I_{EN}	EN input leakage current	$V_{EN} = 6.0\text{V}$ and $V_{IN} = 6.0\text{V}$			90	250	nA
$R_{\text{EN}(\text{PULL-DOWN})}$	Smart enable pulldown resistor	$V_{EN} = 0.25\text{V}$			500		K Ω

(1) Design simulation data only.

5.6 Switching Characteristics

at operating temperature range ($T_J = -40^{\circ}\text{C}$ to $+125^{\circ}\text{C}$), $V_{IN} = V_{OUT(NOM)} + 0.3\text{V}$ or 1.6V , whichever is greater, $V_{EN} = 1.0\text{V}$, $I_{OUT} = 1\text{mA}$, $C_{IN} = 1\mu\text{F}$, $C_{OUT} = 1\mu\text{F}$, C_{OUT} ESL = 300pH , C_{OUT} ESR = $8\text{m}\Omega$, board ESL = 1.5nH , board ESR = $5\text{m}\Omega$ (unless otherwise noted); all typical values are at $T_J = 25^{\circ}\text{C}$

PARAMETER		TEST CONDITIONS	MIN	TYP	MAX	UNIT
t_{STR}	Start-up time	From $V_{EN} > V_{\text{EN}(\text{HI})}$ to $V_{OUT} = 95\%$ of $V_{OUT(\text{NOM})}$,		750	1150	μs

5.7 Typical Characteristics

$V_{IN} = V_{OUT(NOM)} + 0.3V$ or $1.6V$ (whichever is greater), $V_{OUT} = 2.85V$, $I_{OUT} = 1mA$, $C_{IN} = 1\mu F$, C_{OUT} (derated) = $0.75\mu F$, and $T_A = 25^\circ C$ (unless otherwise noted)

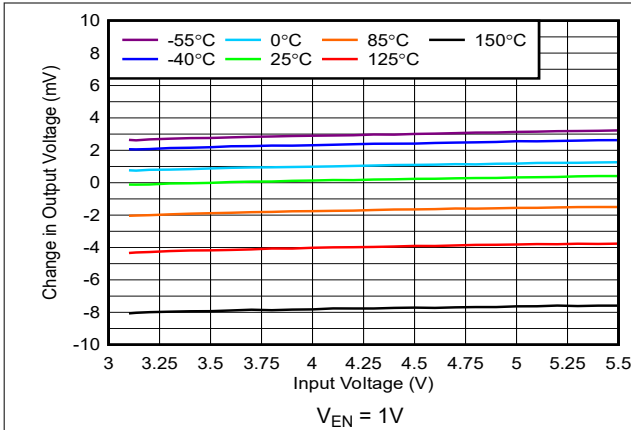

Figure 5-1. Line Regulation

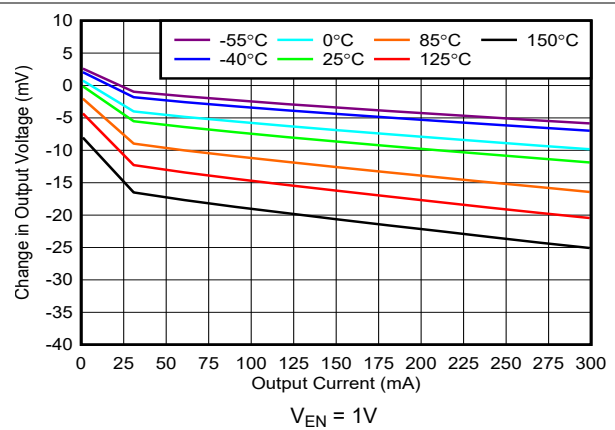

Figure 5-2. Load Regulation

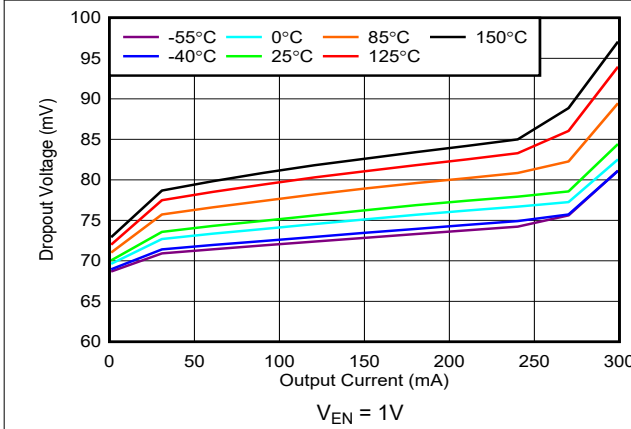

Figure 5-3. Dropout Voltage vs I_{OUT}

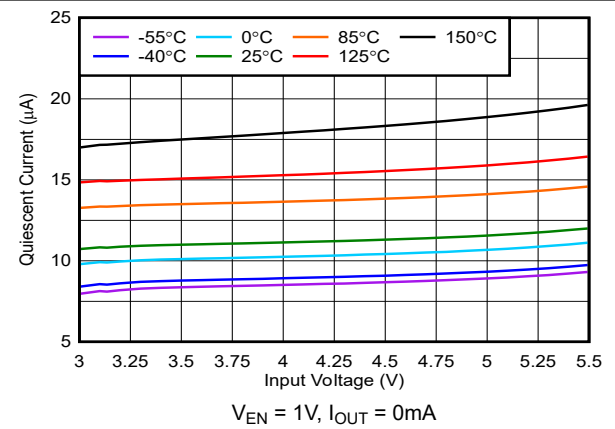

Figure 5-4. I_{GND} vs V_{IN}

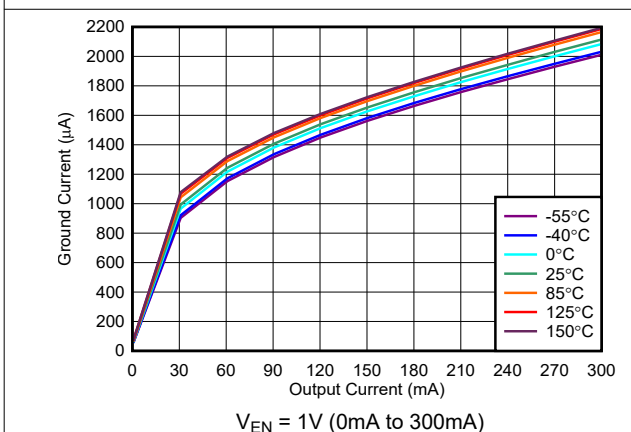

Figure 5-5. I_{GND} vs I_{OUT}

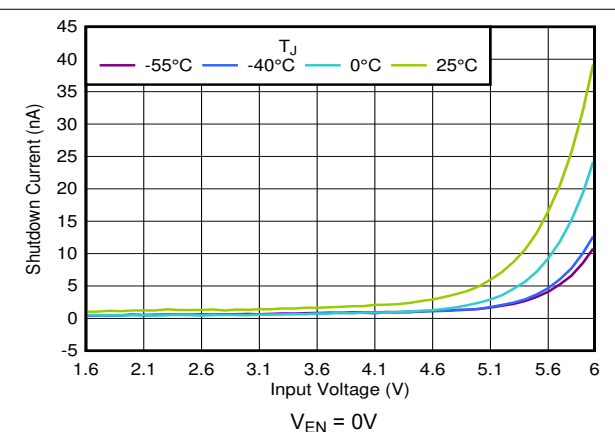

Figure 5-6. Shutdown Current vs V_{IN}

5.7 Typical Characteristics (continued)

$V_{IN} = V_{OUT(NOM)} + 0.3V$ or $1.6V$ (whichever is greater), $V_{OUT} = 2.85V$, $I_{OUT} = 1mA$, $C_{IN} = 1\mu F$, C_{OUT} (derated) = $0.75\mu F$, and $T_A = 25^\circ C$ (unless otherwise noted)

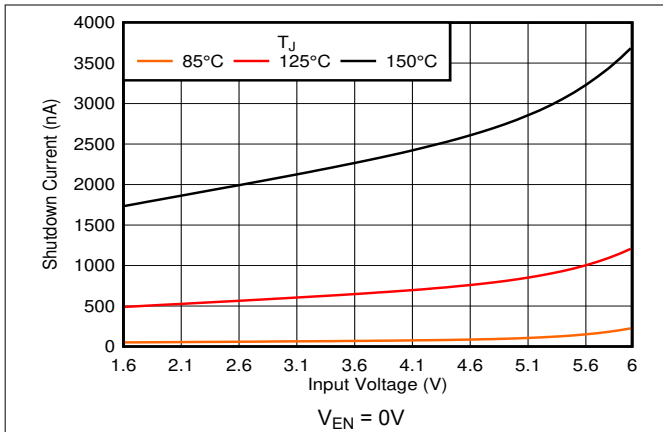

Figure 5-7. Shutdown Current vs V_{IN}

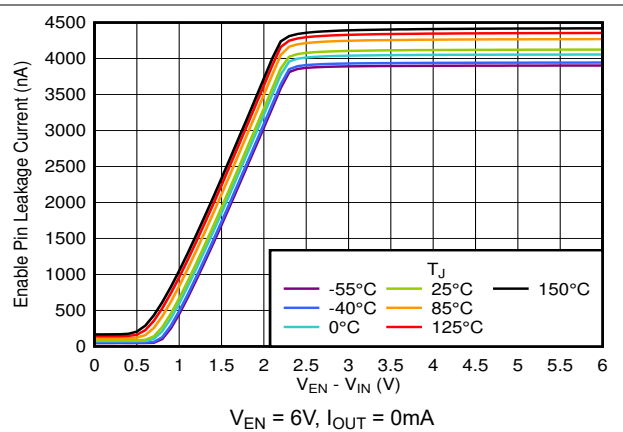

Figure 5-8. Enable Pin Leakage Current vs $V_{EN} - V_{IN}$

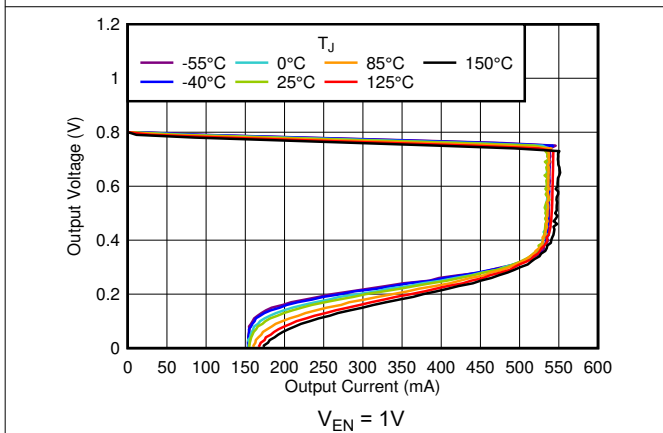

Figure 5-9. Current Limit

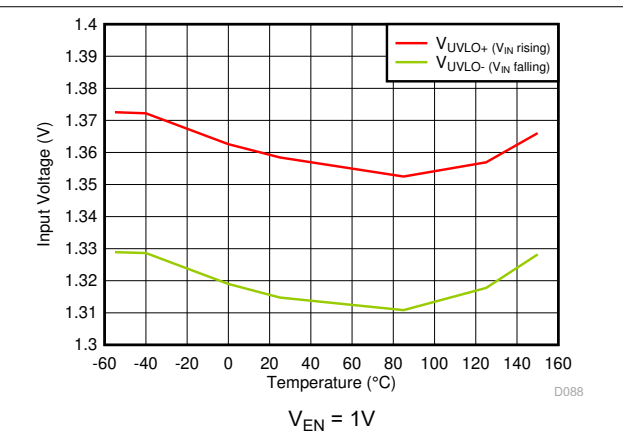

Figure 5-10. UVLO Threshold vs Temperature

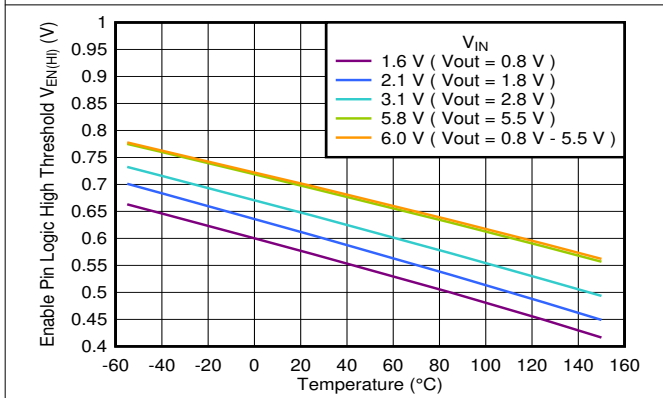

Figure 5-11. Enable Logic High Threshold vs Temperature

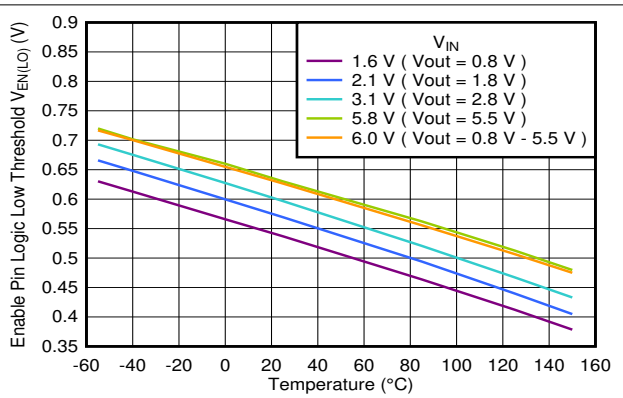

Figure 5-12. Enable Logic Low Threshold vs Temperature

5.7 Typical Characteristics (continued)

$V_{IN} = V_{OUT(NOM)} + 0.3V$ or $1.6V$ (whichever is greater), $V_{OUT} = 2.85V$, $I_{OUT} = 1mA$, $C_{IN} = 1\mu F$, C_{OUT} (derated) = $0.75\mu F$, and $T_A = 25^\circ C$ (unless otherwise noted)

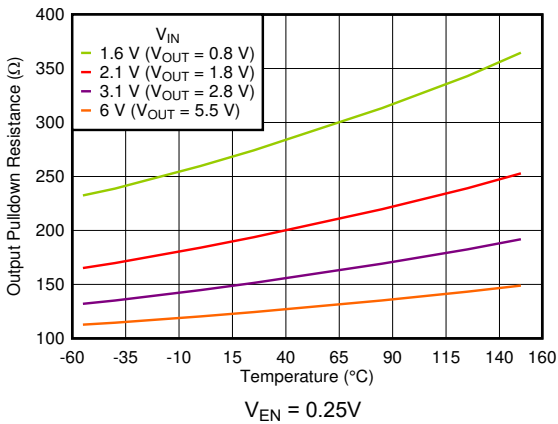

Figure 5-13. Output Pulldown Resistor vs Temperature

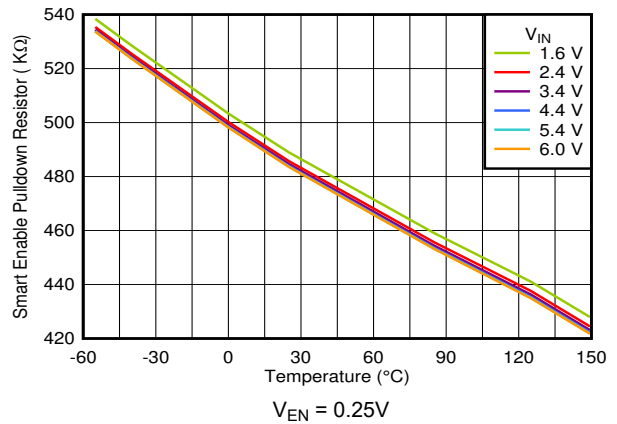
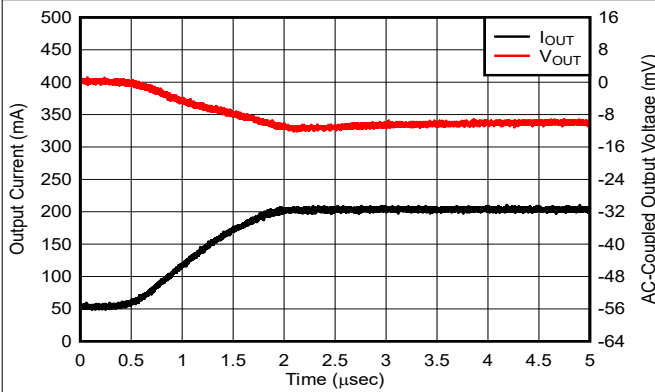
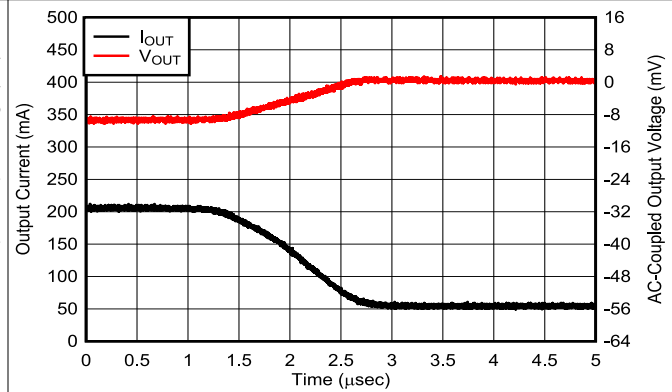

Figure 5-14. Smart Enable Pulldown Resistor vs Temperature and V_{IN}



$I_{OUT} = 50mA$ to $200mA$, $t_{RISING} = 1\mu s$

Figure 5-15. Load Transient



$I_{OUT} = 200mA$ to $50mA$, $t_{FALLING} = 1\mu s$

Figure 5-16. Load Transient

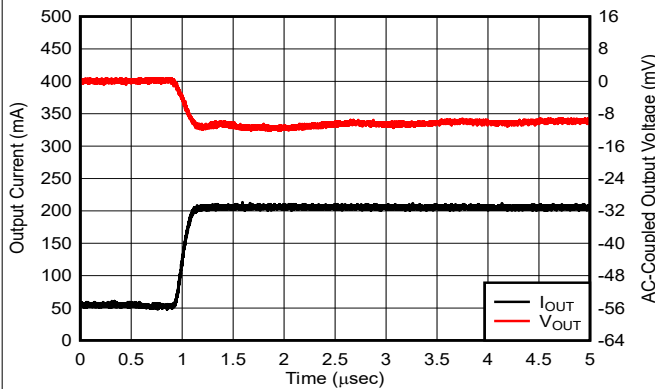

$I_{OUT} = 50mA$ to $200mA$, $t_{RISING} = 150ns$

Figure 5-17. Load Transient

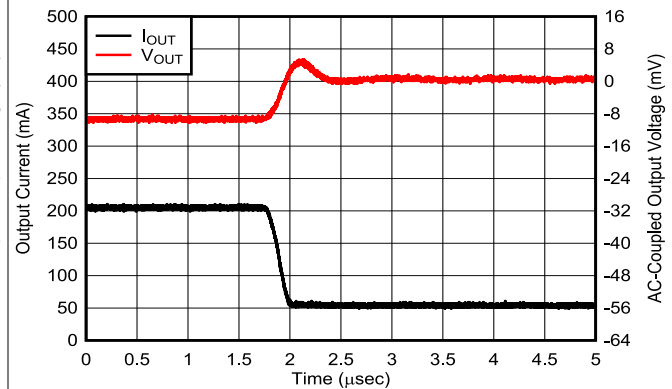

$I_{OUT} = 200mA$ to $50mA$, $t_{FALLING} = 150ns$

Figure 5-18. Load Transient

5.7 Typical Characteristics (continued)

$V_{IN} = V_{OUT(NOM)} + 0.3V$ or $1.6V$ (whichever is greater), $V_{OUT} = 2.85V$, $I_{OUT} = 1mA$, $C_{IN} = 1\mu F$, C_{OUT} (derated) = $0.75\mu F$, and $T_A = 25^\circ C$ (unless otherwise noted)

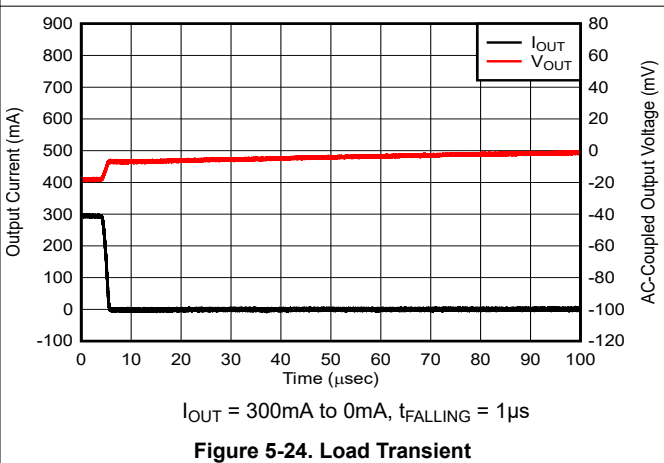
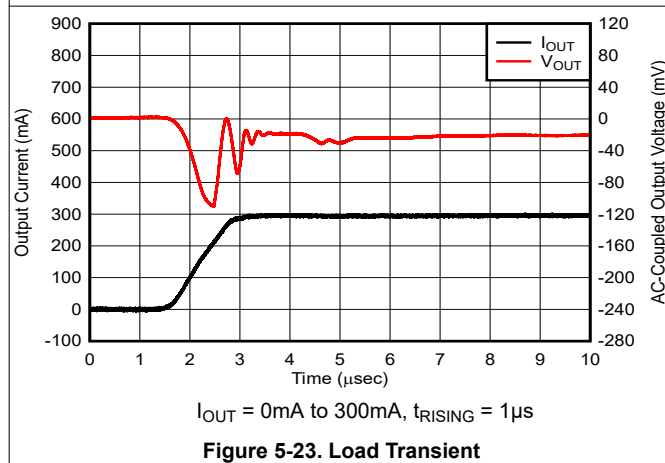
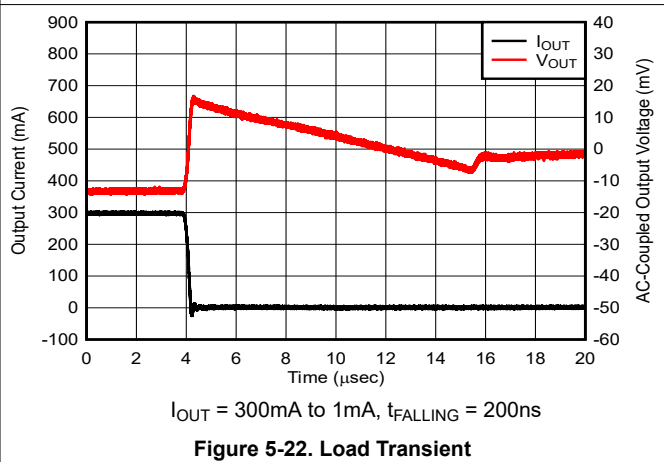
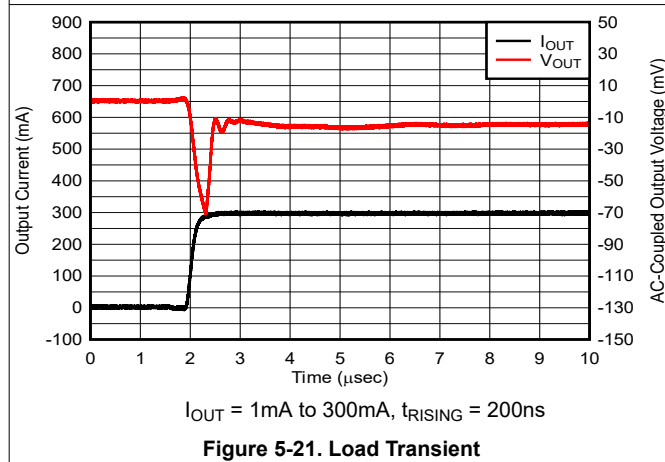
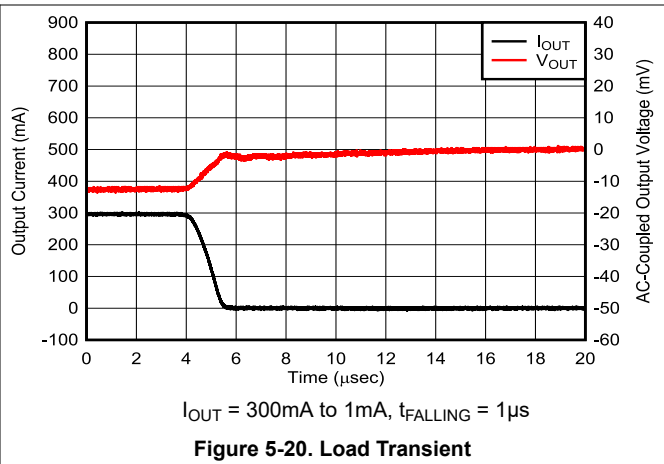
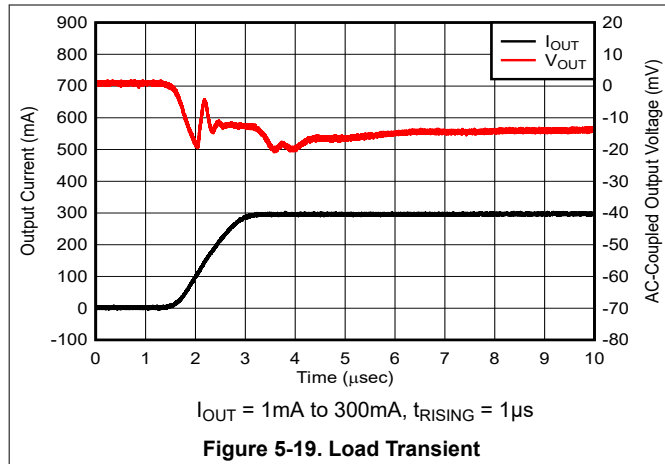

5.7 Typical Characteristics (continued)

$V_{IN} = V_{OUT(NOM)} + 0.3V$ or $1.6V$ (whichever is greater), $V_{OUT} = 2.85V$, $I_{OUT} = 1mA$, $C_{IN} = 1\mu F$, C_{OUT} (derated) = $0.75\mu F$, and $T_A = 25^\circ C$ (unless otherwise noted)

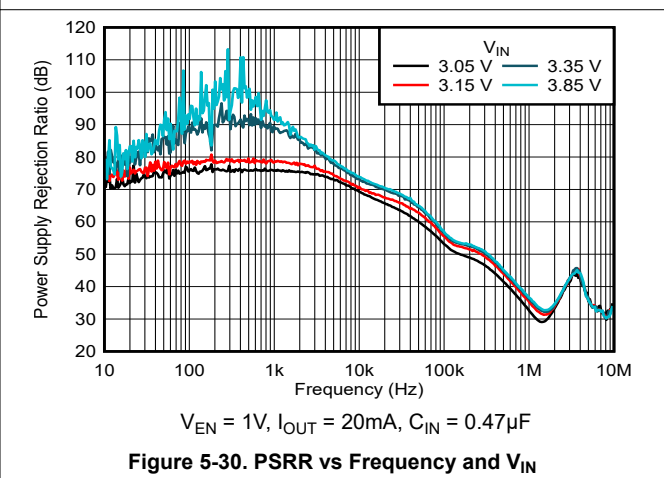
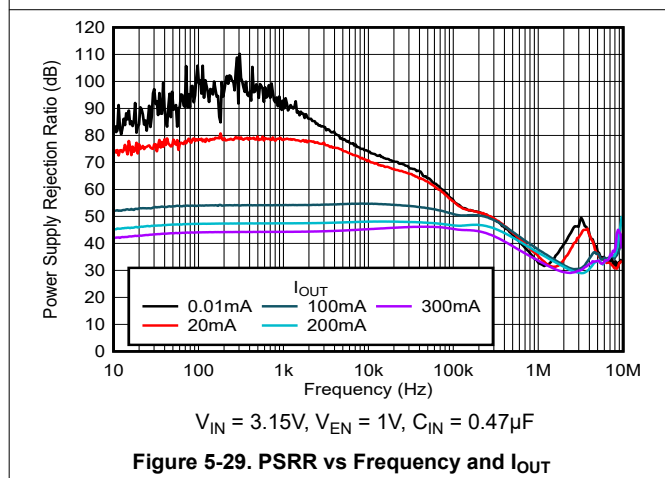
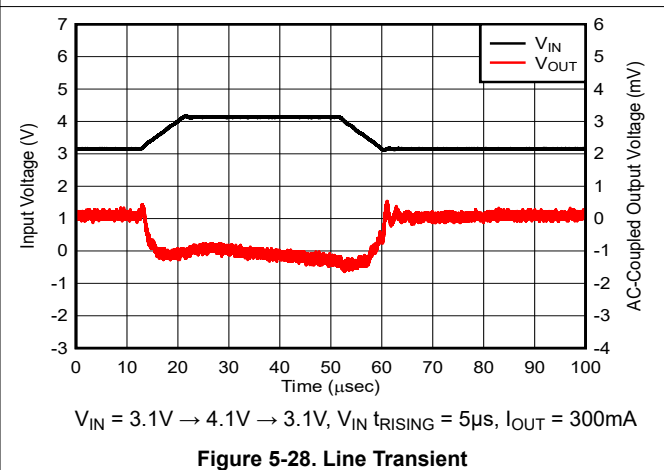
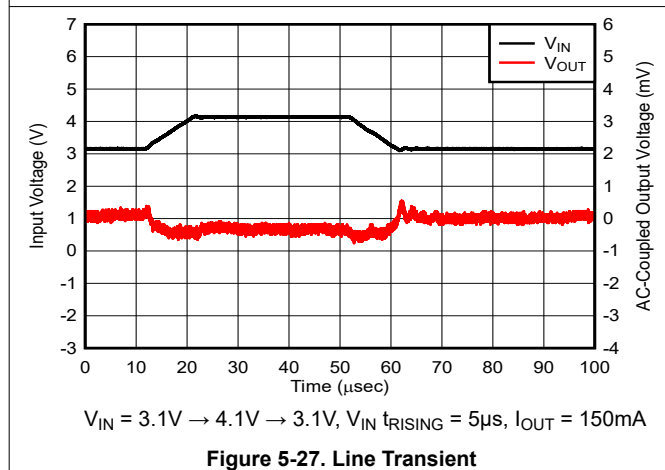
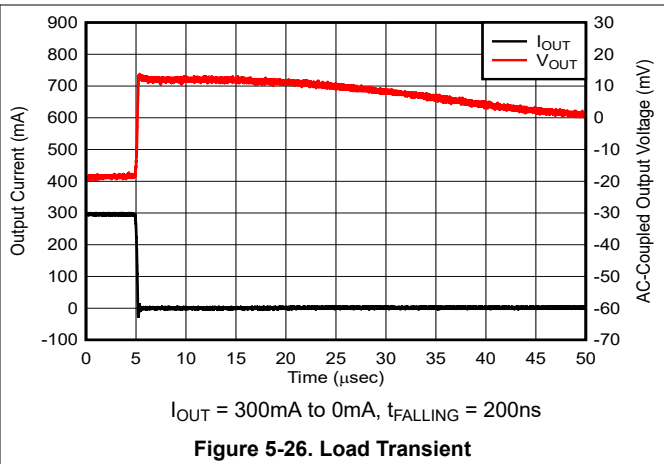
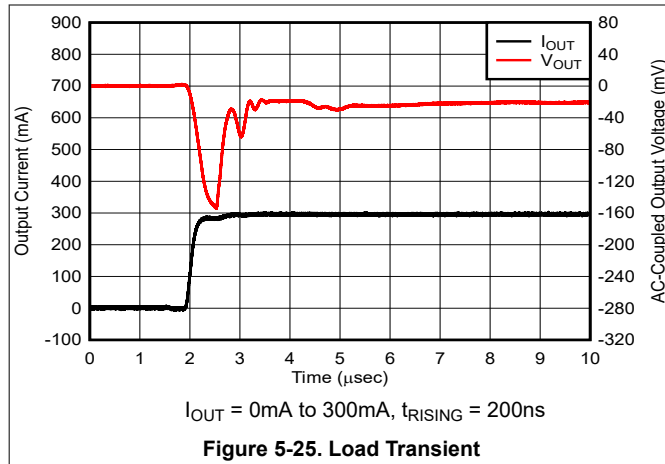

5.7 Typical Characteristics (continued)

$V_{IN} = V_{OUT(NOM)} + 0.3V$ or $1.6V$ (whichever is greater), $V_{OUT} = 2.85V$, $I_{OUT} = 1mA$, $C_{IN} = 1\mu F$, C_{OUT} (derated) = $0.75\mu F$, and $T_A = 25^\circ C$ (unless otherwise noted)

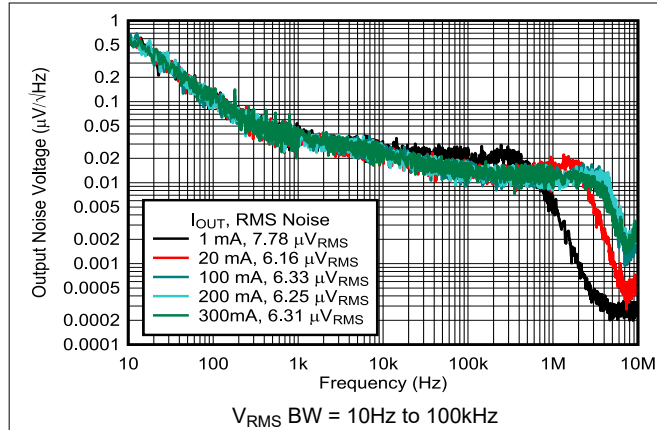

Figure 5-31. Noise vs Frequency and I_{OUT}

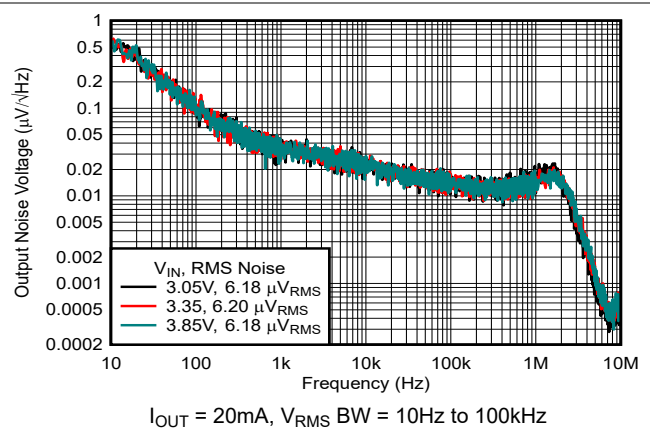

Figure 5-32. Noise vs Frequency and V_{IN}

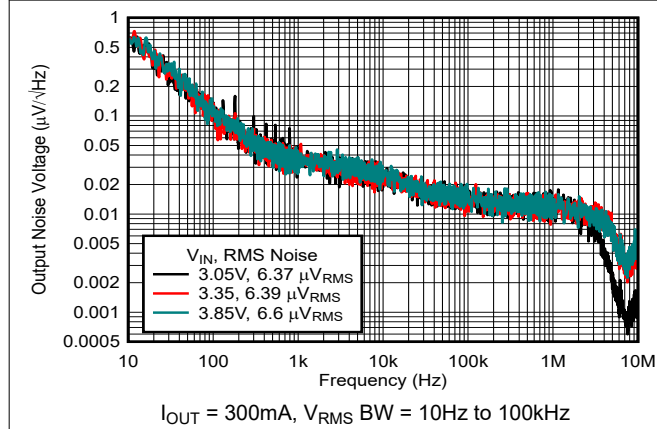

Figure 5-33. Noise vs Frequency and V_{IN}

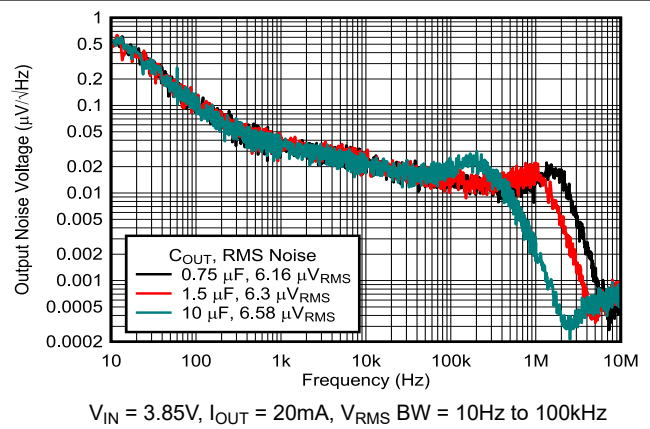

Figure 5-34. Noise vs Frequency and C_{OUT}

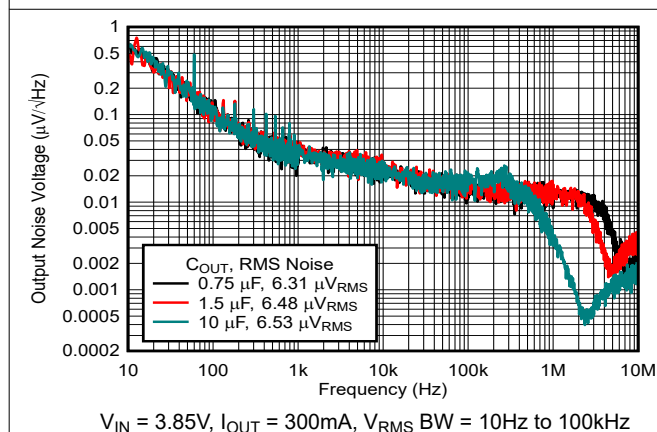

Figure 5-35. Noise vs Frequency and C_{OUT}

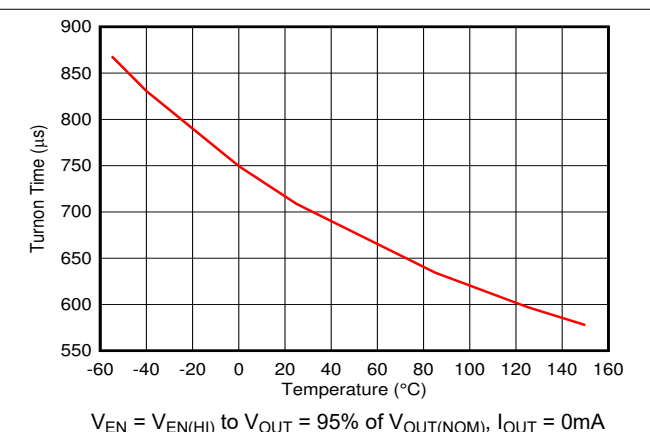
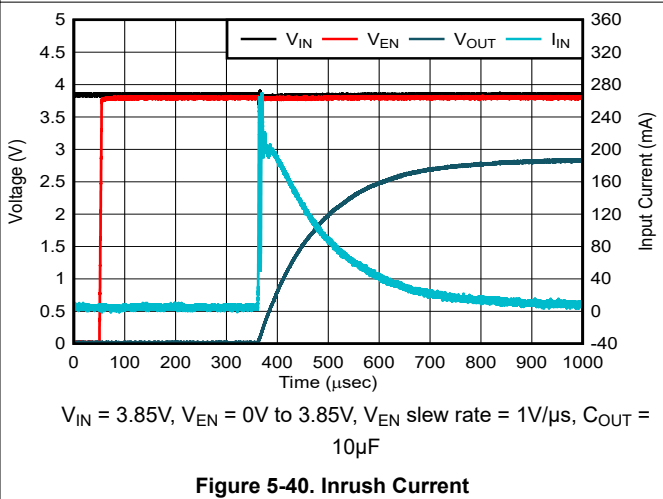
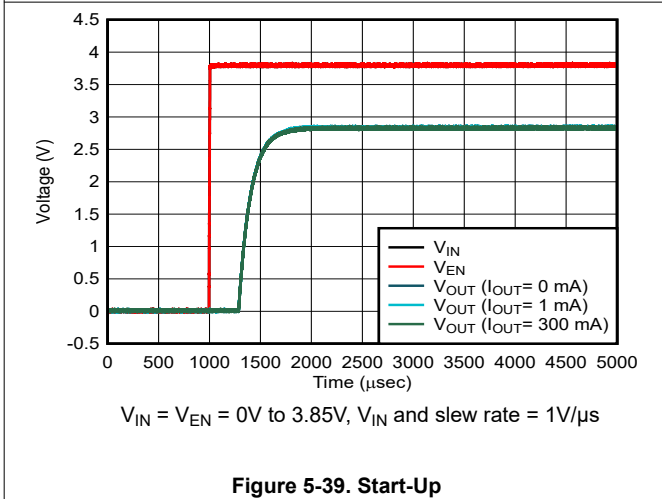
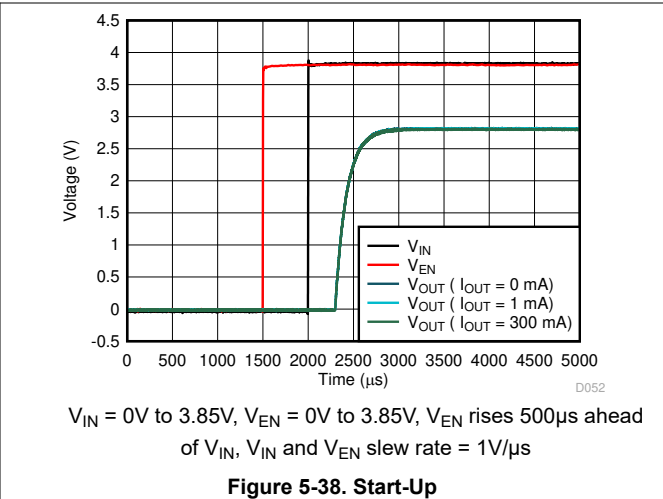
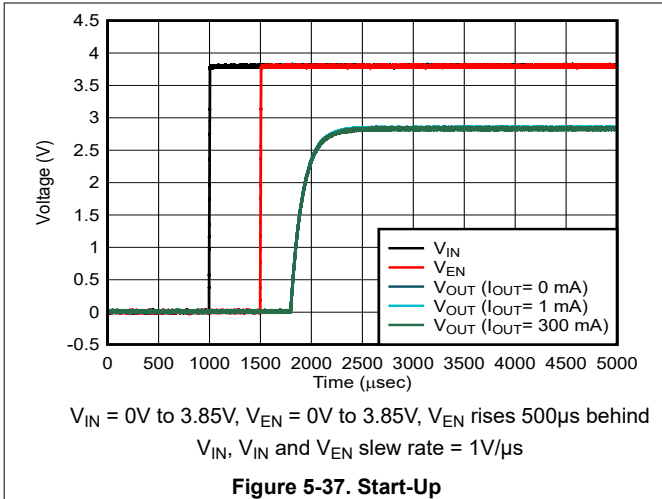

Figure 5-36. Start-Up Turn-On Time

5.7 Typical Characteristics (continued)

$V_{IN} = V_{OUT(NOM)} + 0.3V$ or $1.6V$ (whichever is greater), $V_{OUT} = 2.85V$, $I_{OUT} = 1mA$, $C_{IN} = 1\mu F$, C_{OUT} (derated) = $0.75\mu F$, and $T_A = 25^\circ C$ (unless otherwise noted)



6 Detailed Description

6.1 Overview

The TPS7A20C provides low noise, high PSRR, low quiescent current, and low line and load transient response figures. This device is designed to meet the needs of sensitive RF and analog circuits. Using innovative design techniques, the TPS7A20C offers class-leading noise performance without the need for a separate noise filter capacitor.

The TPS7A20C is designed to operate with a single 1 μ F input capacitor. The device also provides excellent load settling performance when used with a single ceramic output capacitor in the 0.75 μ F to 1.5 μ F range.

6.2 Functional Block Diagram

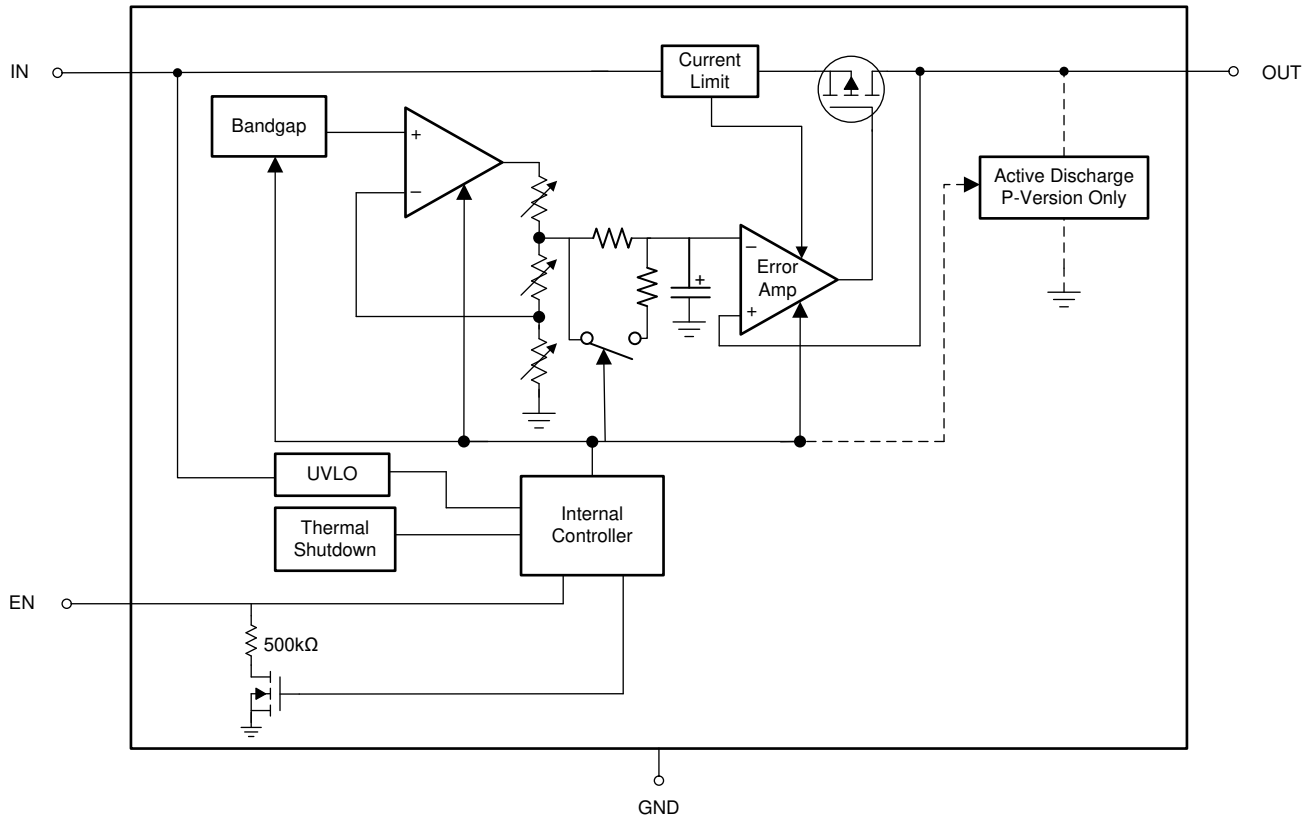

6.3 Feature Description

6.3.1 Fast Settling

This LDO is designed to settle quickly in response to load transients up to 200mA. Use output capacitance in the 0.5µF to 1.5µF range and ESL less than 2.5nH for fast load transient settling.

6.3.2 Low Output Noise

Any internal noise at the TPS7A20C reference voltage is reduced by a first-order, low-pass RC filter before being passed to the output buffer stage. The low-pass RC filter has a –3dB cut-off frequency of approximately 0.1Hz.

During start-up, the filter resistor is bypassed to reduce output rise time. The filter begins normal operation after the output voltage reaches the correct value.

6.3.3 Dropout Voltage

Dropout voltage (V_{DO}) is defined as $V_{IN} - V_{OUT}$ at the rated output current (I_{RATED}), where the pass transistor is fully on. V_{IN} is the input voltage, V_{OUT} is the output voltage, and I_{RATED} is the maximum I_{OUT} listed in the [Recommended Operating Conditions](#) table. At this operating point, the pass transistor is driven fully on. Dropout voltage indirectly specifies a minimum input voltage greater than the nominal programmed output voltage where the output voltage is expected to stay in regulation. If the input voltage falls to less than the nominal output regulation, then the output voltage falls as well.

For a CMOS regulator, the dropout voltage is determined by the drain-source, on-state resistance ($R_{DS(ON)}$) of the pass transistor. Therefore, if the linear regulator operates at less than the rated current, the dropout voltage for that current scales accordingly. The following equation calculates the $R_{DS(ON)}$ of the device.

$$R_{DS(ON)} = \frac{V_{DO}}{I_{RATED}} \quad (1)$$

6.3.4 Smart Enable

The enable (EN) input polarity is active high. The output voltage is enabled when the enable input voltage is greater than $V_{EN(HI)}$ and disabled when the enable input voltage is less than $V_{EN(LOW)}$. If independent control of the output voltage is not needed, connect EN to IN.

This device has a smart enable circuit to reduce quiescent current. When the enable pin voltage is driven above $V_{EN(HI)}$, the device is enabled and the smart enable internal pulldown resistor ($R_{EN(PULLDOWN)}$) is disconnected. See the [Electrical Characteristics](#) table. When the enable pin is floating, $R_{EN(PULLDOWN)}$ is connected and pulls the enable pin low to disable the device. The $R_{EN(PULLDOWN)}$ value is listed in the [Electrical Characteristics](#) table.

6.3.5 Current Limit

The device has an internal current limit circuit that protects the regulator during transient high-load current faults or shorting events. The current limit is a hybrid brick-wall-foldback scheme. The current limit transitions from a brick-wall scheme to a foldback scheme at the foldback voltage ($V_{FOLDBACK}$). In a high-load current fault with the output voltage above $V_{FOLDBACK}$, the brick-wall scheme limits the output current to the current limit (I_{CL}). When the voltage drops below $V_{FOLDBACK}$, a foldback current limit activates that scales back the current as the output voltage approaches GND. When the output is shorted, the device supplies a typical current called the short-circuit current limit (I_{SC}). I_{CL} and I_{SC} are listed in the [Electrical Characteristics](#) table.

The output voltage is not regulated when the device is in current limit. When a current limit event occurs, the device begins to heat up because of the increase in power dissipation. When the device is in brick-wall current limit, the pass transistor dissipates power $[(V_{IN} - V_{OUT}) \times I_{CL}]$. When the device output is shorted and the output is below $V_{FOLDBACK}$, the pass transistor dissipates power $[(V_{IN} - V_{OUT}) \times I_{SC}]$. If thermal shutdown is triggered, the device turns off. After the device cools down, the internal thermal shutdown circuit turns the device back on. If the output current fault condition continues, the device cycles between current limit and thermal shutdown. For more information on current limits, see the [Know Your Limits application note](#).

Figure 6-1 shows a diagram of the foldback current limit.

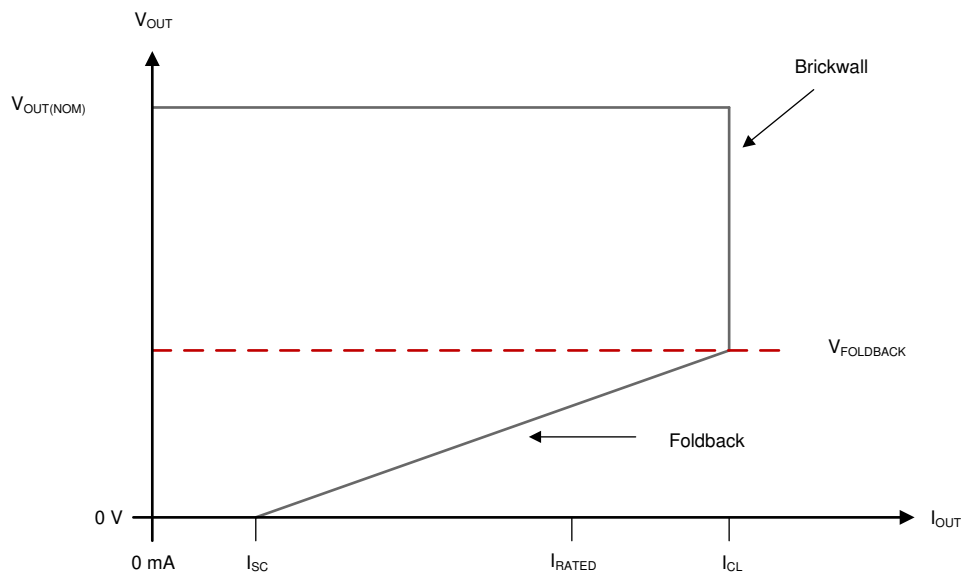

Figure 6-1. Foldback Current Limit

6.3.6 Undervoltage Lockout (UVLO)

The device has an independent undervoltage lockout (UVLO) circuit that monitors the input voltage. This circuit allows for a controlled and consistent turn on and off of the output voltage. To prevent the device from turning off if the input drops during turn on, the UVLO has hysteresis, as specified in the [Electrical Characteristics](#) table.

6.3.7 Thermal Shutdown

A thermal shutdown protection circuit disables the LDO when the junction temperature (T_J) of the pass transistor rises to $T_{SD(shutdown)}$ (typical). Thermal shutdown hysteresis makes sure that the device resets (turns on) when the temperature falls to $T_{SD(reset)}$ (typical).

The thermal time-constant of the semiconductor die is fairly short. Thus, the device cycles on and off when thermal shutdown is reached until power dissipation is reduced. Power dissipation during start-up is high from large $V_{IN} - V_{OUT}$ voltage drops across the device or from high inrush currents charging large output capacitors. Under some conditions, the thermal shutdown protection disables the device before start-up completes.

For reliable operation, limit the junction temperature to the maximum listed in the [Recommended Operating Conditions](#) table. Operation above this maximum temperature causes the device to exceed operational specifications. Although the internal device protection circuitry is designed to protect against thermal overload conditions, this circuitry is not intended to replace proper heat sinking. Continuously running the device into thermal shutdown or above the maximum recommended junction temperature reduces long-term reliability.

6.3.8 Active Discharge

An internal pulldown MOSFET connects a resistor from OUT to ground when the device is disabled to actively discharge the output capacitance. The active discharge circuit is activated by driving EN low or by the voltage on IN falling below the undervoltage lockout (UVLO) threshold.

Do not rely on the active discharge circuit for discharging a large amount of output capacitance after the input supply has collapsed. Reverse current potentially flows from the output to the input. This reverse current flow causes damage to the device. Limit reverse current to no more than 5% of the device rated current for a short period of time.

6.4 Device Functional Modes

6.4.1 Device Functional Mode Comparison

Table 6-1 shows the conditions that lead to the different modes of operation. See the [Electrical Characteristics](#) table for parameter values.

Table 6-1. Device Functional Mode Comparison

OPERATING MODE	PARAMETER			
	V_{IN}	V_{EN}	I_{OUT}	T_J
Normal operation	$V_{IN} > V_{OUT(nom)} + V_{DO}$ and $V_{IN} > V_{IN(min)}$	$V_{EN} > V_{EN(HI)}$	$I_{OUT} < I_{OUT(max)}$	$T_J < T_{SD(shutdown)}$
Dropout operation	$V_{IN(min)} < V_{IN} < V_{OUT(nom)} + V_{DO}$	$V_{EN} > V_{EN(HI)}$	$I_{OUT} < I_{OUT(max)}$	$T_J < T_{SD(shutdown)}$
Disabled (any true condition disables the device)	$V_{IN} < V_{UVLO}$	$V_{EN} < V_{EN(LOW)}$	Not applicable	$T_J > T_{SD(shutdown)}$

6.4.2 Normal Operation

The device regulates to the nominal output voltage when the following conditions are met:

- The input voltage is greater than the nominal output voltage plus the dropout voltage ($V_{OUT(nom)} + V_{DO}$)
- The output current is less than the current limit ($I_{OUT} < I_{CL}$)
- The device junction temperature is less than the thermal shutdown temperature ($T_J < T_{SD}$)
- The enable voltage has previously exceeded the enable rising threshold voltage and has not yet decreased to less than the enable falling threshold

6.4.3 Dropout Operation

If the input voltage is lower than the nominal output voltage plus the specified dropout voltage, the device operates in dropout mode. In this mode, the output voltage tracks the input voltage. In this mode, the transient performance of the device becomes significantly degraded. During this mode, the pass transistor is driven fully on. Line or load transients in dropout potentially result in large output voltage deviations.

When the device is in a steady dropout state, the pass transistor is driven fully on. This state is defined as when the device is in dropout, directly after being in a normal regulation state, but *not* during start-up. Dropout occurs when $V_{IN} < V_{OUT(NOM)} + V_{DO}$. When the regulator exits dropout, the input voltage returns to a value $\geq V_{OUT(NOM)} + V_{DO}$. During this time, the output voltage potentially overshoots for a short period of time. $V_{OUT(NOM)}$ is the nominal output voltage and V_{DO} is the dropout voltage. During dropout exit, the device pulls the pass transistor back from being driven fully on.

6.4.4 Disabled

Shut down the output of the LDO by driving EN to less than $V_{EN(LOW)}$ (see the [Electrical Characteristics](#) table). When disabled, the pass transistor is turned off and internal circuits are shut down. The output voltage is also actively discharged to ground by an internal discharge circuit between OUT and ground.

7 Application and Implementation

Note

Information in the following applications sections is not part of the TI component specification, and TI does not warrant its accuracy or completeness. TI's customers are responsible for determining suitability of components for their purposes, as well as validating and testing their design implementation to confirm system functionality.

7.1 Application Information

7.1.1 Recommended Capacitor Types

The device is designed to be stable using low equivalent series resistance (ESR) ceramic capacitors at the input and output. Multilayer ceramic capacitors have become the industry standard for these types of applications and are recommended, but use good judgment. Ceramic capacitors that employ X7R-, X5R-, and C0G-rated dielectric materials provide relatively good capacitive stability across temperature. Using Y5V-rated capacitors is discouraged because of large variations in capacitance.

Regardless of the ceramic capacitor type selected, the effective capacitance varies with operating voltage and temperature. Generally, expect the effective capacitance to decrease by as much as 50%. The input and output capacitors listed in the [Recommended Operating Conditions](#) table account for an effective capacitance of approximately 50% of the nominal value.

7.1.2 Input and Output Capacitor Requirements

Although the LDO is stable without an input capacitor, good analog design practice is to connect a capacitor from IN to GND. Make sure this capacitor has a value at least equal to the nominal value specified in the [Recommended Operating Conditions](#) table. The input capacitor counteracts reactive input sources and improves transient response, input ripple, and PSRR. Use this capacitor if the source impedance is greater than 0.5Ω . When the source resistance and inductance are sufficiently high, especially in the presence of load transients, the overall system is susceptible to instability. Instability includes ringing, sustained oscillation, and other performance degradation if there is insufficient capacitance between IN and GND. Use a capacitor with a value greater than the minimum if large, fast-rise-time load or line transients are anticipated. Also use this capacitor if the device is located more than a few centimeters from the input power source.

An output capacitor of an appropriate value helps provide stability and improve dynamic performance. Use an output capacitor within the range specified in the [Recommended Operating Conditions](#) table. For fastest settling time, keep the derated output capacitance in the $0.75\mu\text{F}$ to $1.5\mu\text{F}$ range. Minimize any inductance (including capacitor ESL) between OUT and the output capacitance to less than $2.5\mu\text{H}$ avoid degrading settling performance.

7.1.3 Load Transient Response

The load-step transient response is the output voltage response by the LDO to a step in load current, whereby output voltage regulation is maintained. There are two key transitions during a load transient response: from a light to a heavy load and from a heavy to a light load. The regions shown in [Figure 7-1](#) are broken down as follows. Regions A, E, and H are where the output voltage is in steady-state.

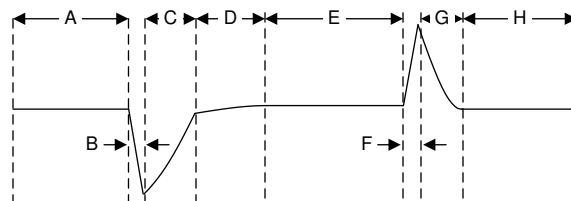

Figure 7-1. Load Transient Waveform

During transitions from a light load to a heavy load, the:

- Initial voltage dip is a result of the depletion of the output capacitor charge and parasitic impedance to the output capacitor (region B)
- Recovery from the dip results from the LDO increasing the sourcing current, and leads to output voltage regulation (region C)

During transitions from a heavy load to a light load, the:

- Initial voltage rise results from the LDO sourcing a large current, and leads to the output capacitor charge to increase (region F)
- Recovery from the rise results from the LDO decreasing the sourcing current in combination with the load discharging the output capacitor (region G)

A larger output capacitance reduces the peaks during a load transient but slows down the response time of the device. A larger DC load also reduces the peaks. The amplitude of the transition is lowered and a higher current discharge path is provided for the output capacitor.

This LDO is designed to provide best transient response performance when the load current is limited to approximately 200mA or less.

7.1.4 Undervoltage Lockout (UVLO) Operation

The UVLO circuit makes sure that the device stays disabled before the input supply reaches the minimum operational voltage range. This circuit also makes sure that the device shuts down when the input supply collapses. Figure 7-2 shows the UVLO circuit response to various input voltage events. The diagram is separated into the following parts:

- Region A: The device does not start until the input reaches the UVLO rising threshold.
- Region B: Normal operation, regulating device.
- Region C: Brownout event above the UVLO falling threshold (UVLO rising threshold – UVLO hysteresis). The output potentially falls out of regulation but the device remains enabled.
- Region D: Normal operation, regulating device.
- Region E: Brownout event below the UVLO falling threshold. The device is disabled in most cases and the output falls because of the load and active discharge circuit. The device is re-enabled when the UVLO rising threshold is reached by the input voltage and a normal start-up follows.
- Region F: Normal operation followed by the input falling to the UVLO falling threshold.
- Region G: The device is disabled when the input voltage falls below the UVLO falling threshold to 0V. The output falls because of the load and active discharge circuit.

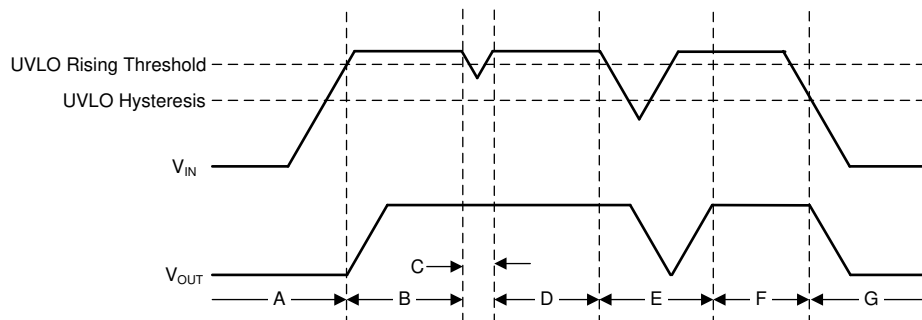

Figure 7-2. Typical UVLO Operation

7.1.5 Power Dissipation (P_D)

Circuit reliability demands that proper consideration be given to device power dissipation, location of the circuit on the PCB, and correct thermal plane sizing. Make sure the printed circuit board (PCB) area around the regulator is as free as possible of other heat-generating devices that cause added thermal stresses.

As a first-order approximation, power dissipation in the regulator depends on the input-to-output voltage difference and load conditions. Use [Equation 2](#) to approximate P_D :

$$P_D = (V_{IN} - V_{OUT}) \times I_{OUT} \quad (2)$$

Power dissipation is minimized, and thus greater efficiency achieved, by proper selection of the system voltage rails. Proper selection allows the minimum input-to-output voltage differential to be obtained. The low dropout of the TPS7A20C allows for maximum efficiency across a wide range of output voltages.

The maximum power dissipation determines the maximum allowable junction temperature (T_J) for the device. According to [Equation 3](#), power dissipation and junction temperature are most often related by the $R_{\theta JA}$ of the combined PCB and device package and the T_A . $R_{\theta JA}$ is the junction-to-ambient thermal resistance and T_A is the ambient air temperature. [Equation 4](#) rearranges [Equation 3](#) for output current.

$$T_J = T_A + (R_{\theta JA} \times P_D) \quad (3)$$

$$I_{OUT} = (T_J - T_A) / [R_{\theta JA} \times (V_{IN} - V_{OUT})] \quad (4)$$

Unfortunately, this thermal resistance ($R_{\theta JA}$) is highly dependent on the heat-spreading capability built into the particular PCB design. Therefore, $R_{\theta JA}$ varies according to the total copper area, copper weight, and location of the planes. The $R_{\theta JA}$ recorded in the [Thermal Information](#) table is determined by the JEDEC standard, PCB, and copper-spreading area. $R_{\theta JA}$ is only used as a relative measure of package thermal performance. For a well-designed thermal layout, $R_{\theta JA}$ is actually the sum of $R_{\theta JC(bot)}$ plus the thermal resistance contribution by the PCB copper. $R_{\theta JC(bot)}$ is the package junction-to-case (bottom) thermal resistance.

7.1.5.1 Estimating Junction Temperature

The JEDEC standard now recommends the use of psi (Ψ) thermal metrics. These metrics estimate the junction temperatures of the LDO when in-circuit on a typical PCB board application. These metrics are not strictly speaking thermal resistances, but rather offer practical and relative means of estimating junction temperatures. These psi metrics are determined to be significantly independent of the copper-spreading area. The key thermal metrics (Ψ_{JT} and Ψ_{JB}) are used in accordance with [Equation 5](#) and are given in the [Thermal Information](#) table.

$$\Psi_{JT} : T_J = T_T + \Psi_{JT} \times P_D \text{ and } \Psi_{JB} : T_J = T_B + \Psi_{JB} \times P_D \quad (5)$$

where:

- P_D is the power dissipated as explained in [Equation 2](#)
- T_T is the temperature at the center-top of the device package
- T_B is the PCB surface temperature measured 1mm from the device package and centered on the package edge

7.1.5.2 Recommended Area for Continuous Operation

The operational area of an LDO is limited by the dropout voltage, output current, junction temperature, and input voltage. The recommended area for continuous operation for a linear regulator is given in [Figure 7-3](#) and is separated into the following parts:

- Dropout voltage limits the minimum differential voltage between the input and the output ($V_{IN} - V_{OUT}$) at a given output current level. See the [Dropout Operation](#) section for more details.
- The rated output currents limits the maximum recommended output current level. Exceeding this rating causes the device to fall out of specification.
- The rated junction temperature limits the maximum junction temperature of the device. Exceeding this rating causes the device to fall out of specification and reduces long-term reliability.
 - The shape of the slope is given by [Equation 4](#). The slope is nonlinear because the maximum-rated junction temperature of the LDO is controlled by the power dissipation across the LDO. Thus, when $V_{IN} - V_{OUT}$ increases the output current decreases.
- The rated input voltage range governs both the minimum and maximum of $V_{IN} - V_{OUT}$.

[Figure 7-3](#) shows the recommended area of operation for this device on a JEDEC-standard high-K board with a $R_{\theta JA}$, as given in the [Thermal Information](#) table.

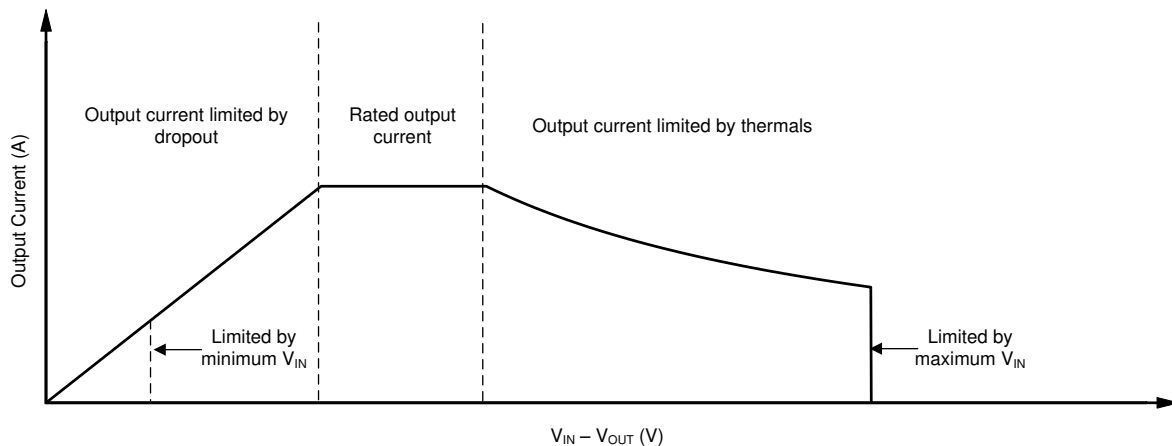

Figure 7-3. Region Description of Continuous Operation Regime

7.2 Typical Application

Figure 7-4 shows the typical application circuit for the TPS7A20C. If needed, increase input and output capacitances above the 1µF minimum for some applications.

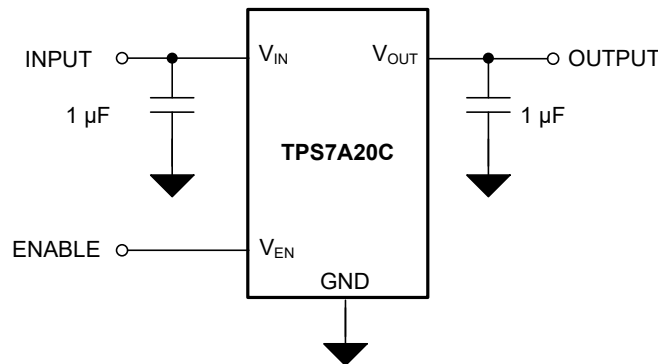

Figure 7-4. TPS7A20C Typical Application

7.2.1 Design Requirements

Table 7-1 summarizes the design requirements for Figure 7-4.

Table 7-1. Design Parameters

DESIGN PARAMETER	EXAMPLE VALUE
Input voltage range	3.1V to 3.6V
Output voltage	2.85V
Output current	200mA
Maximum ambient temperature	85°C

7.2.2 Detailed Design Procedure

For this design example, the 2.85V output version (TPS7A20C285) is selected. A nominal 3.3V input supply is assumed. Use a minimum 1.0µF input capacitor to minimize the effect of resistance and inductance between the 3.3V source and the LDO input. Also use a nominal 1.0µF output capacitor for stability and good load transient response. The dropout voltage (V_{DO}) is less than 140mV maximum at a 2.85V output voltage and 300mA output current. Thus, there are no dropout issues with a 3.0V minimum input voltage and a maximum 200mA output current.

7.2.3 Application Curve

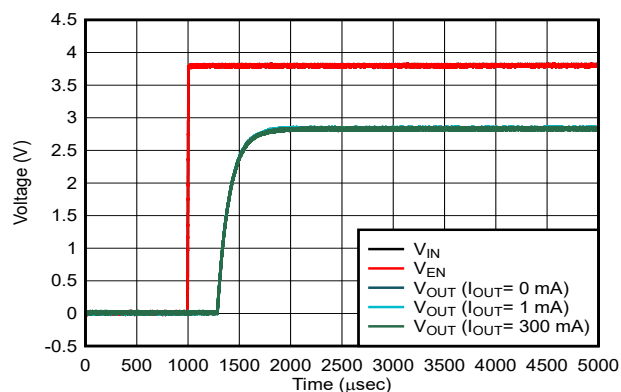

Figure 7-5. Start-Up

7.3 Power Supply Recommendations

This device is designed to operate from an input supply voltage range of 1.6V to 6.0V. Make sure the input supply is well regulated and free of spurious noise. Set the input supply to be at least $V_{OUT(nom)} + 0.3V$ or 1.6V, whichever is greater. This setting makes sure that the output voltage is well regulated and dynamic performance is optimum. Use a 1 μ F or greater input capacitor to reduce the impedance of the input supply, especially during transients.

7.4 Layout

7.4.1 Layout Guidelines

- Place input and output capacitors as close to the device as possible
- Use copper planes for device connections to optimize thermal performance
- Place thermal vias around the device to distribute the heat

7.4.2 Layout Example

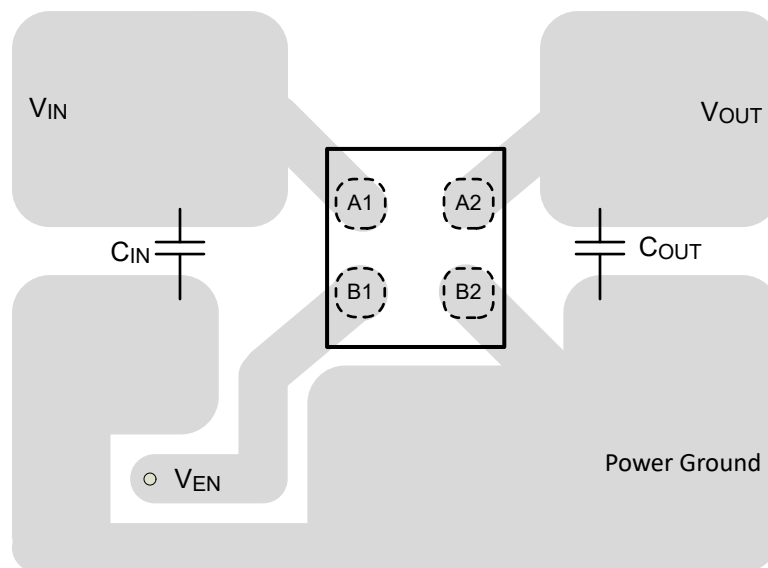

Figure 7-6. YCK Package (DSBGA) Typical Layout

8 Device and Documentation Support

8.1 Device Support

8.1.1 Device Nomenclature

Table 8-1. Device Nomenclature

PRODUCT ^{(1) (2)}	V _{OUT}
TPS7A20Cxx(x)Pyyyz	<p>xx(x) is the nominal output voltage. For output voltages with a resolution of 100mV, two digits are used in the ordering number. Otherwise, three digits are used (for example, 28 = 2.8V; 125 = 1.25V).</p> <p>P indicates an active output discharge feature.</p> <p>yyy is the package designator.</p> <p>z is the package quantity. R is for reel (12000 pieces for YCK).</p>

- (1) For the most current package and ordering information see the Package Option Addendum at the end of this document, or visit the device product folder on www.ti.com.
- (2) Output voltages from 0.8V to 5.5V in 25mV increments are available. Contact the factory for details and availability.

8.2 Receiving Notification of Documentation Updates

To receive notification of documentation updates, navigate to the device product folder on ti.com. Click on *Notifications* to register and receive a weekly digest of any product information that has changed. For change details, review the revision history included in any revised document.

8.3 Support Resources

[TI E2E™ support forums](#) are an engineer's go-to source for fast, verified answers and design help — straight from the experts. Search existing answers or ask your own question to get the quick design help you need.

Linked content is provided "AS IS" by the respective contributors. They do not constitute TI specifications and do not necessarily reflect TI's views; see TI's [Terms of Use](#).

8.4 Trademarks

TI E2E™ is a trademark of Texas Instruments.
All trademarks are the property of their respective owners.

8.5 Electrostatic Discharge Caution



This integrated circuit can be damaged by ESD. Texas Instruments recommends that all integrated circuits be handled with appropriate precautions. Failure to observe proper handling and installation procedures can cause damage.

ESD damage can range from subtle performance degradation to complete device failure. Precision integrated circuits may be more susceptible to damage because very small parametric changes could cause the device not to meet its published specifications.

8.6 Glossary

[TI Glossary](#) This glossary lists and explains terms, acronyms, and definitions.

9 Revision History

NOTE: Page numbers for previous revisions may differ from page numbers in the current version.

DATE	REVISION	NOTES
August 2024	*	Initial Release

10 Mechanical, Packaging, and Orderable Information

The following pages include mechanical, packaging, and orderable information. This information is the most current data available for the designated devices. This data is subject to change without notice and revision of this document. For browser-based versions of this data sheet, refer to the left-hand navigation.

10.1 Mechanical Data



PACKAGE OUTLINE

YCK0004-C01

DSBGA - 0.33mm MAX HEIGHT

DIE SIZE BALL GRID ARRAY

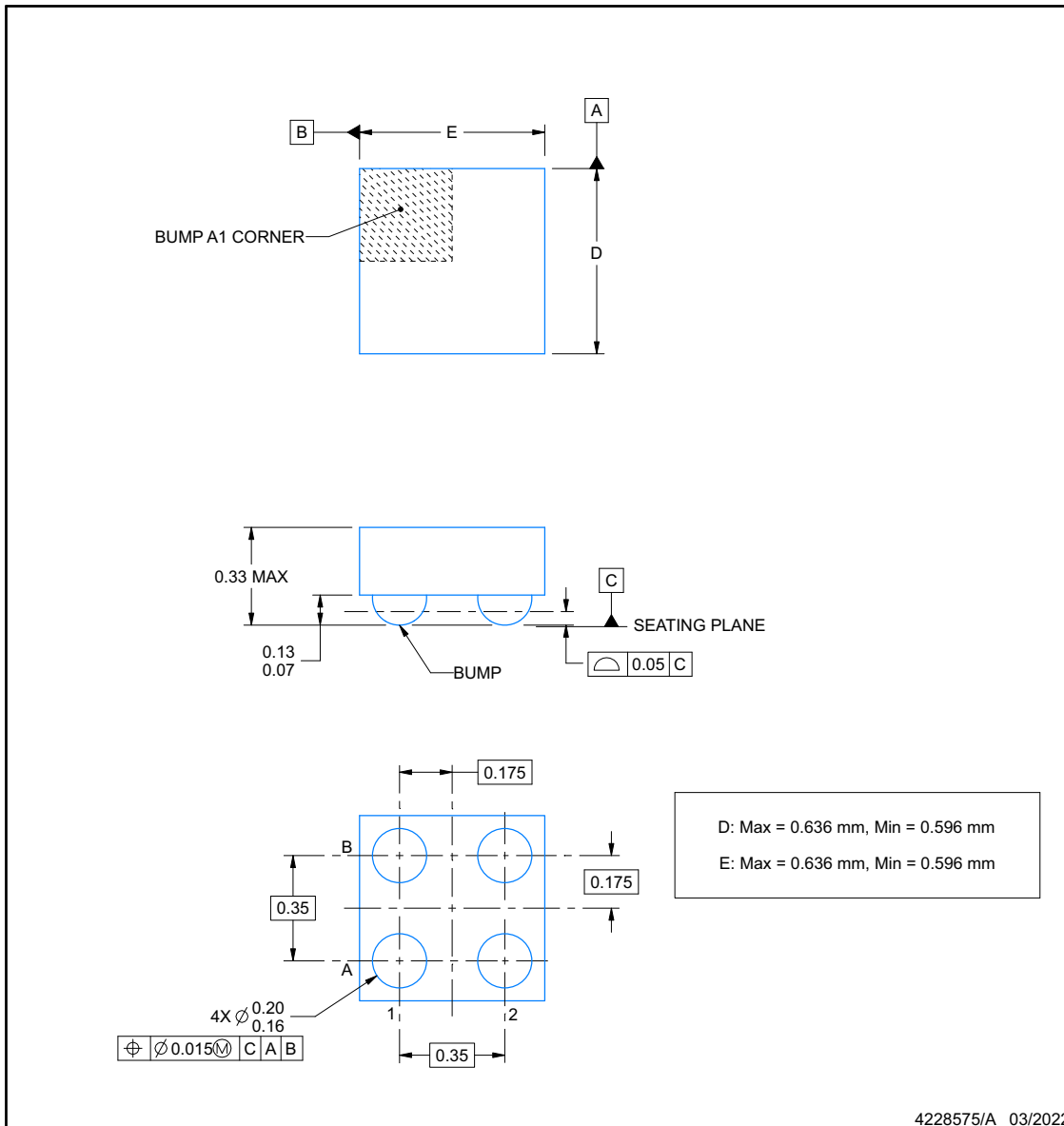

NOTES:

1. All linear dimensions are in millimeters. Dimensions in parenthesis are for reference only. Dimensioning and tolerancing per ASME Y14.5M.
2. This drawing is subject to change without notice.

EXAMPLE BOARD LAYOUT

YCK0004-C01

DSBGA - 0.33mm MAX HEIGHT

DIE SIZE BALL GRID ARRAY

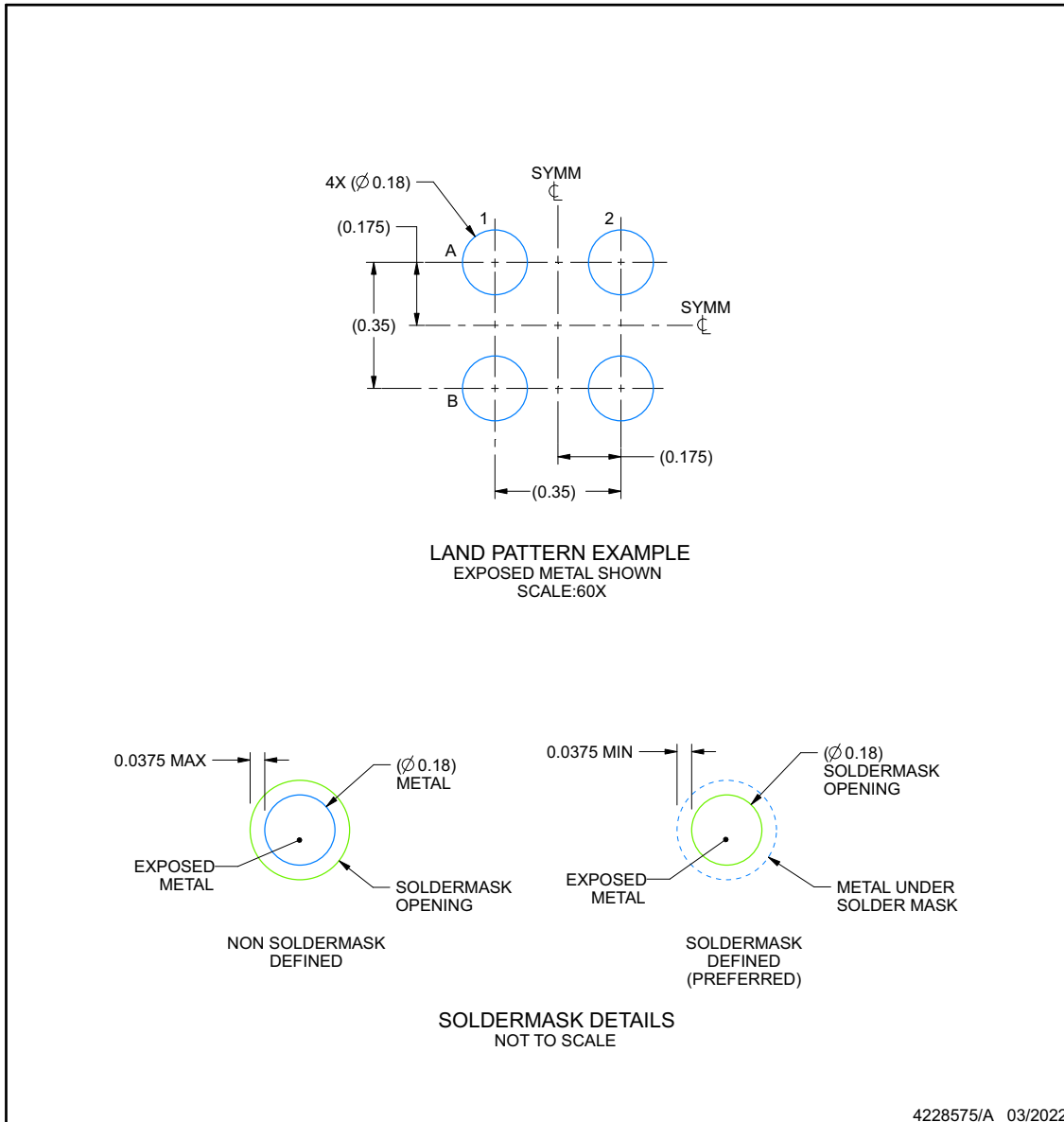

NOTES: (continued)

- Final dimensions may vary due to manufacturing tolerance considerations and also routing constraints. Refer to Texas Instruments Literature No. SNVA009 (www.ti.com/lit/snva009).

EXAMPLE STENCIL DESIGN

YCK0004-C01

DSBGA - 0.33mm MAX HEIGHT

DIE SIZE BALL GRID ARRAY

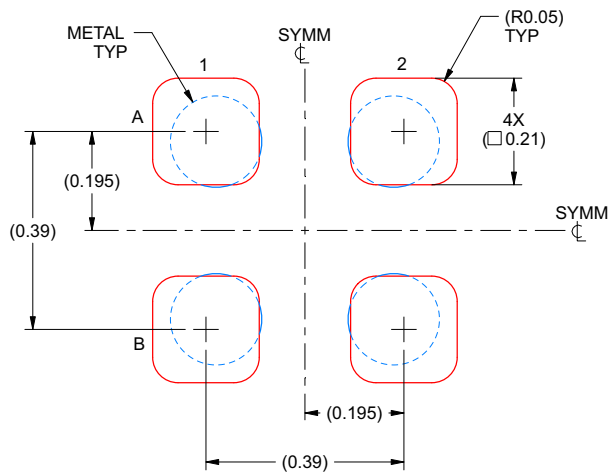

SOLDERPASTE EXAMPLE
BASED ON 0.075 mm THICK STENCIL
SCALE:80X

4228575/A 03/2022

NOTES: (continued)

4. Laser cutting apertures with trapezoidal walls and rounded corners may offer better paste release.

PACKAGING INFORMATION

Orderable Device	Status (1)	Package Type	Package Drawing	Pins	Package Qty	Eco Plan (2)	Lead finish/ Ball material (6)	MSL Peak Temp (3)	Op Temp (°C)	Device Marking (4/5)	Samples
TPS7A20C285PYCKR	ACTIVE	DSBGA	YCK	4	12000	RoHS & Green	SNAGCU	Level-1-260C-UNLIM	-40 to 125	C	Samples

(1) The marketing status values are defined as follows:

ACTIVE: Product device recommended for new designs.

LIFEBUY: TI has announced that the device will be discontinued, and a lifetime-buy period is in effect.

NRND: Not recommended for new designs. Device is in production to support existing customers, but TI does not recommend using this part in a new design.

PREVIEW: Device has been announced but is not in production. Samples may or may not be available.

OBSELETE: TI has discontinued the production of the device.

(2) **RoHS:** TI defines "RoHS" to mean semiconductor products that are compliant with the current EU RoHS requirements for all 10 RoHS substances, including the requirement that RoHS substance do not exceed 0.1% by weight in homogeneous materials. Where designed to be soldered at high temperatures, "RoHS" products are suitable for use in specified lead-free processes. TI may reference these types of products as "Pb-Free".

RoHS Exempt: TI defines "RoHS Exempt" to mean products that contain lead but are compliant with EU RoHS pursuant to a specific EU RoHS exemption.

Green: TI defines "Green" to mean the content of Chlorine (Cl) and Bromine (Br) based flame retardants meet JS709B low halogen requirements of <=1000ppm threshold. Antimony trioxide based flame retardants must also meet the <=1000ppm threshold requirement.

(3) MSL, Peak Temp. - The Moisture Sensitivity Level rating according to the JEDEC industry standard classifications, and peak solder temperature.

(4) There may be additional marking, which relates to the logo, the lot trace code information, or the environmental category on the device.

(5) Multiple Device Markings will be inside parentheses. Only one Device Marking contained in parentheses and separated by a "~" will appear on a device. If a line is indented then it is a continuation of the previous line and the two combined represent the entire Device Marking for that device.

(6) Lead finish/Ball material - Orderable Devices may have multiple material finish options. Finish options are separated by a vertical ruled line. Lead finish/Ball material values may wrap to two lines if the finish value exceeds the maximum column width.

Important Information and Disclaimer:The information provided on this page represents TI's knowledge and belief as of the date that it is provided. TI bases its knowledge and belief on information provided by third parties, and makes no representation or warranty as to the accuracy of such information. Efforts are underway to better integrate information from third parties. TI has taken and continues to take reasonable steps to provide representative and accurate information but may not have conducted destructive testing or chemical analysis on incoming materials and chemicals. TI and TI suppliers consider certain information to be proprietary, and thus CAS numbers and other limited information may not be available for release.

In no event shall TI's liability arising out of such information exceed the total purchase price of the TI part(s) at issue in this document sold by TI to Customer on an annual basis.

TAPE AND REEL INFORMATION

QUADRANT ASSIGNMENTS FOR PIN 1 ORIENTATION IN TAPE

*All dimensions are nominal

Device	Package Type	Package Drawing	Pins	SPQ	Reel Diameter (mm)	Reel Width W1 (mm)	A0 (mm)	B0 (mm)	K0 (mm)	P1 (mm)	W (mm)	Pin1 Quadrant
TPS7A20C285PYCKR	DSBGA	YCK	4	12000	180.0	8.4	0.71	0.71	0.42	2.0	8.0	Q1
TPS7A20C285PYCKR	DSBGA	YCK	4	12000	180.0	8.4	0.71	0.71	0.42	2.0	8.0	Q1

TAPE AND REEL BOX DIMENSIONS

*All dimensions are nominal

Device	Package Type	Package Drawing	Pins	SPQ	Length (mm)	Width (mm)	Height (mm)
TPS7A20C285PYCKR	DSBGA	YCK	4	12000	182.0	182.0	20.0
TPS7A20C285PYCKR	DSBGA	YCK	4	12000	182.0	182.0	20.0

IMPORTANT NOTICE AND DISCLAIMER

TI PROVIDES TECHNICAL AND RELIABILITY DATA (INCLUDING DATA SHEETS), DESIGN RESOURCES (INCLUDING REFERENCE DESIGNS), APPLICATION OR OTHER DESIGN ADVICE, WEB TOOLS, SAFETY INFORMATION, AND OTHER RESOURCES "AS IS" AND WITH ALL FAULTS, AND DISCLAIMS ALL WARRANTIES, EXPRESS AND IMPLIED, INCLUDING WITHOUT LIMITATION ANY IMPLIED WARRANTIES OF MERCHANTABILITY, FITNESS FOR A PARTICULAR PURPOSE OR NON-INFRINGEMENT OF THIRD PARTY INTELLECTUAL PROPERTY RIGHTS.

These resources are intended for skilled developers designing with TI products. You are solely responsible for (1) selecting the appropriate TI products for your application, (2) designing, validating and testing your application, and (3) ensuring your application meets applicable standards, and any other safety, security, regulatory or other requirements.

These resources are subject to change without notice. TI grants you permission to use these resources only for development of an application that uses the TI products described in the resource. Other reproduction and display of these resources is prohibited. No license is granted to any other TI intellectual property right or to any third party intellectual property right. TI disclaims responsibility for, and you will fully indemnify TI and its representatives against, any claims, damages, costs, losses, and liabilities arising out of your use of these resources.

TI's products are provided subject to [TI's Terms of Sale](#) or other applicable terms available either on [ti.com](https://www.ti.com) or provided in conjunction with such TI products. TI's provision of these resources does not expand or otherwise alter TI's applicable warranties or warranty disclaimers for TI products.

TI objects to and rejects any additional or different terms you may have proposed.

Mailing Address: Texas Instruments, Post Office Box 655303, Dallas, Texas 75265
Copyright © 2024, Texas Instruments Incorporated