

# TPS7A37 1% High-Accuracy, 1-A, Low-Dropout Regulator With Reverse Current Protection

## 1 Features

- Stable with 1- $\mu$ F or Larger Ceramic Output Capacitor
- Input Voltage Range: 2.2 V to 5.5 V
- Ultralow Dropout Voltage:
  - 200-mV Maximum at 1 A
- Excellent Load Transient Response—Even With Only 1- $\mu$ F Output Capacitor
- NMOS Topology Delivers Low Reverse Leakage Current
- Excellent Accuracy:
  - 0.23% Nominal Accuracy
  - 1% Overall Accuracy Over Line, Over Load, and Over Temperature
- Less Than 20-nA typical  $I_Q$  in Shutdown Mode
- Thermal Shutdown and Current Limit for Fault Protection

## 2 Applications

- Point of Load Regulation for DSPs, FPGAs, ASICs, and Microprocessors
- Post-Regulation for Switching Supplies
- Portable and Battery-Powered Equipment

### Typical Application Circuit (Adjustable Version)

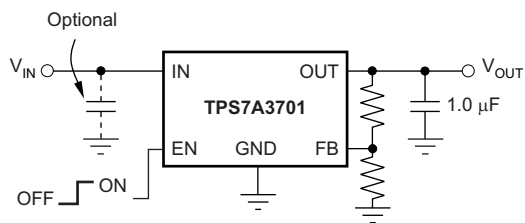

## 3 Description

The TPS7A37 family of linear low-dropout (LDO) voltage regulators uses an NMOS pass element in a voltage-follower configuration. This topology is relatively insensitive to output capacitor value and ESR, allowing a wide variety of load configurations. Load transient response is excellent, even with a small 1- $\mu$ F ceramic output capacitor. The NMOS topology also allows very low dropout.

The TPS7A37 family uses an advanced BiCMOS process to yield high precision while delivering very low dropout voltages and low ground pin current. Current consumption, when not enabled, is under 20 nA and ideal for portable applications. These devices are protected by thermal shutdown and foldback current limit.

### Device Information<sup>(1)</sup>

| PART NUMBER | PACKAGE  | BODY SIZE (NOM)   |
|-------------|----------|-------------------|
| TPS7A37     | WSON (6) | 2.00 mm x 2.00 mm |

(1) For all available packages, see the orderable addendum at the end of the data sheet.

### Typical Application Circuit (Fixed Version)

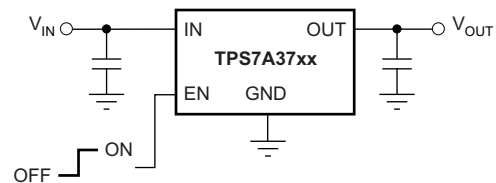

## Table of Contents

|  |           |  |           |
|--|-----------|--|-----------|
| <b>1 Features</b> .....                        | <b>1</b>  | <b>8 Application and Implementation</b> .....    | <b>14</b> |
| <b>2 Applications</b> .....                    | <b>1</b>  | 8.1 Application Information.....                 | 14        |
| <b>3 Description</b> .....                     | <b>1</b>  | 8.2 Typical Applications .....                   | 16        |
| <b>4 Revision History</b> .....                | <b>2</b>  | <b>9 Power Supply Recommendations</b> .....      | <b>19</b> |
| <b>5 Pin Configuration and Functions</b> ..... | <b>3</b>  | <b>10 Layout</b> .....                           | <b>19</b> |
| <b>6 Specifications</b> .....                  | <b>3</b>  | 10.1 Layout Guidelines .....                     | 19        |
| 6.1 Absolute Maximum Ratings .....             | 3         | 10.2 Layout Example .....                        | 19        |
| 6.2 ESD Ratings.....                           | 3         | 10.3 Thermal Considerations .....                | 20        |
| 6.3 Recommended Operating Conditions .....     | 4         | 10.4 Power Dissipation .....                     | 20        |
| 6.4 Thermal Information .....                  | 4         | 10.5 Estimating Junction Temperature .....       | 21        |
| 6.5 Electrical Characteristics.....            | 5         | <b>11 Device and Documentation Support</b> ..... | <b>23</b> |
| 6.6 Typical Characteristics .....              | 6         | 11.1 Documentation Support .....                 | 23        |
| <b>7 Detailed Description</b> .....            | <b>11</b> | 11.2 Trademarks .....                            | 23        |
| 7.1 Overview .....                             | 11        | 11.3 Electrostatic Discharge Caution.....        | 23        |
| 7.2 Functional Block Diagrams .....            | 11        | 11.4 Glossary .....                              | 23        |
| 7.3 Feature Description.....                   | 12        | <b>12 Mechanical, Packaging, and Orderable</b>   |           |
| 7.4 Device Functional Modes.....               | 13        | <b>Information</b> .....                         | <b>23</b> |

## 4 Revision History

NOTE: Page numbers for previous revisions may differ from page numbers in the current version.

| <b>Changes from Revision A (July 2013) to Revision B</b>  | <b>Page</b> |
|---|-------------|
| <ul style="list-style-type: none"> <li>Added <i>ESD Ratings</i> table, <i>Feature Description</i> section, <i>Device Functional Modes</i>, <i>Application and Implementation</i> section, <i>Power Supply Recommendations</i> section, <i>Layout</i> section, <i>Device and Documentation Support</i> section, and <i>Mechanical, Packaging, and Orderable Information</i> section. ....</li> </ul> | 1           |
| <ul style="list-style-type: none"> <li>Changed Internal Reference (VFB) parameter typ value .....</li> </ul>  | 5           |

| <b>Changes from Original (March 2013) to Revision A</b>  | <b>Page</b> |
|--|-------------|
| <ul style="list-style-type: none"> <li>Changed device status to Production Data .....</li> </ul> | 1           |

## 5 Pin Configuration and Functions

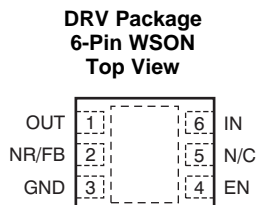

Power dissipation may limit operating range. Check [Thermal Information](#) table.

### Pin Functions

| PIN      |        | I/O | DESCRIPTION  |
|----------|--------|-----|--|
| NAME     | NO.    |     |  |
| EN       | 4      | I   | Driving the enable pin (EN) high turns on the regulator. Driving this pin low puts the regulator into shutdown mode. Refer to the <a href="#">Shutdown</a> section under <a href="#">Applications Information</a> for more details. EN must not be left floating and can be connected to IN if not used. |
| FB       | 2      | I   | Adjustable voltage version only—this pin is the input to the control loop error amplifier, and is used to set the output voltage of the device.  |
| GND      | 3, Pad | —   | Ground   |
| IN       | 6      | I   | Unregulated input supply   |
| N/C      | 5      | —   | Not connected  |
| NR/FB    | 2      | —   | Fixed voltage versions only—connecting an external capacitor to this pin bypasses noise generated by the internal bandgap, reducing output noise to very low levels.   |
| OUT      | 1      | O   | Regulator output. A 1.0- $\mu$ F or larger capacitor of any type is required for stability.  |
| PowerPAD | —      | —   |  |

## 6 Specifications

### 6.1 Absolute Maximum Ratings

Over operating temperature range (unless otherwise noted).<sup>(1)</sup>

|             |                               | MIN                | MAX | UNIT |
|-------------|-------------------------------|--------------------|-----|------|
| Voltage     | IN                            | -0.3               | 6   | V    |
|             | EN                            | -0.3               | 6   | V    |
|             | OUT                           | -0.3               | 5.5 | V    |
|             | NR, FB                        | -0.3               | 6   | V    |
| Current     | Peak output current           | Internally limited |     | A    |
|             | Output short-circuit duration | Indefinite         |     | A    |
| Temperature | Operating junction, $T_J$     | -55                | 150 | °C   |
|             | Storage, $T_{stg}$            | -65                | 150 | °C   |

- (1) Stresses beyond those listed under *Absolute Maximum Ratings* may cause permanent damage to the device. These are stress ratings only, which do not imply functional operation of the device at these or any other conditions beyond those indicated under *Recommended Operating Conditions*. Exposure to absolute-maximum-rated conditions for extended periods may affect device reliability.

### 6.2 ESD Ratings

|                                     |  | VALUE      | UNIT |
|-------------------------------------|--|------------|------|
| $V_{(ESD)}$ Electrostatic discharge | Human-body model (HBM), per ANSI/ESDA/JEDEC JS-001 <sup>(1)</sup>              | $\pm 2000$ | V    |
|                                     | Charged-device model (CDM), per JEDEC specification JESD22-C101 <sup>(2)</sup> | $\pm 500$  |      |

- (1) JEDEC document JEP155 states that 500-V HBM allows safe manufacturing with a standard ESD control process.  
(2) JEDEC document JEP157 states that 250-V CDM allows safe manufacturing with a standard ESD control process.

### 6.3 Recommended Operating Conditions

over operating free-air temperature range (unless otherwise noted)

|                 | MIN      | NOM                          | MAX            | UNIT       |
|-----------------|----------|------------------------------|----------------|------------|
| $V_{IN}$        | 2.2      |                              | 5.5            | V          |
| $V_{OUT}$       | $V_{FB}$ |                              | $5.5 - V_{DO}$ | V          |
| $V_{EN}$        | 0        |                              | $V_{IN}$       |            |
| $I_{OUT}$       | 0        |                              | 1              | A          |
| $C_{IN}$        |          | 1                            |                | $\mu$ F    |
| $C_{OUT}^{(1)}$ | 1        |                              |                | $\mu$ F    |
| $C_{NR}$        |          | 10                           |                | nF         |
| $R_1^{(2)}$     |          | $V_{OUT(nom)} \times 15.833$ |                | k $\Omega$ |
| $C_{FF}$        |          | 10                           | 100            | nF         |

 (1) If the product of  $C_{OUT} \times ESR < 50$  n $\Omega$ -F, the part may ring after a transient.

(2) This nominal value is for the best accuracy.

### 6.4 Thermal Information

| THERMAL METRIC <sup>(1)</sup> |  | TPS7A37    | UNIT           |
|-------------------------------|--|------------|----------------|
|                               |  | DRV (WSON) |                |
|                               |  | 6 PINS     |                |
| $R_{\theta JA}$               | Junction-to-ambient thermal resistance       | 67.2       | $^{\circ}$ C/W |
| $R_{\theta JC(top)}$          | Junction-to-case (top) thermal resistance    | 87.6       | $^{\circ}$ C/W |
| $R_{\theta JB}$               | Junction-to-board thermal resistance         | 36.8       | $^{\circ}$ C/W |
| $\psi_{JT}$                   | Junction-to-top characterization parameter   | 1.8        | $^{\circ}$ C/W |
| $\psi_{JB}$                   | Junction-to-board characterization parameter | 37.2       | $^{\circ}$ C/W |
| $R_{\theta JC(bot)}$          | Junction-to-case (bottom) thermal resistance | 7.7        | $^{\circ}$ C/W |

 (1) For more information about traditional and new thermal metrics, see the *Semiconductor and IC Package Thermal Metrics* application report, [SPRA953](http://www.ti.com/lit/zip/Spra953).

## 6.5 Electrical Characteristics

Over operating temperature range ( $T_J = -40^\circ\text{C}$  to  $125^\circ\text{C}$ ),  $V_{IN} = V_{OUT(nom)} + 1\text{ V}^{(1)}$ ,  $I_{OUT} = 10\text{ mA}$ ,  $V_{EN} = 2.2\text{ V}$ , and  $C_{OUT} = 2.2\text{ }\mu\text{F}$ , unless otherwise noted. Typical values are at  $T_J = 25^\circ\text{C}$ .

| PARAMETER  |  | TEST CONDITIONS   | MIN                      | TYP                 | MAX            | UNIT                |
|--|--|---|--------------------------|---------------------|----------------|---------------------|
| $V_{IN}$   | Input voltage range <sup>(1)(2)</sup>  |   | 2.2                      |                     | 5.5            | V                   |
| $V_{FB}$   | Internal reference   | $T_J = 25^\circ\text{C}$  | 1.192                    | 1.204               | 1.216          | V                   |
| $V_{OUT}$  | Output voltage range   | TPS7A3701 <sup>(3)</sup>  | $V_{FB}$                 |                     | $5.5 - V_{DO}$ | V                   |
|  | Accuracy <sup>(1), (4)</sup>   | Nominal   | $T_J = 25^\circ\text{C}$ | 0.23%               |                |                     |
| over $V_{IN}$ , $I_{OUT}$ , and $T_J = -40^\circ\text{C}$ to $125^\circ\text{C}$ |  | $V_{OUT} + 0.5\text{ V} \leq V_{IN} \leq 5.5\text{ V}$ ;<br>$10\text{ mA} \leq I_{OUT} \leq 1\text{ A}$ | -1%                      |                     | +1.0%          |                     |
| $\Delta V_{O(\Delta V)}$   | Line regulation <sup>(1)</sup>   | $V_{OUT(nom)} + 0.5\text{ V} \leq V_{IN} \leq 5.5\text{ V}$   |                          | 0.01                | 0.03           | %/V                 |
| $\Delta V_{O(\Delta I)}$   | Load regulation  | $0.1\text{ mA} \leq I_{OUT} \leq 300\text{ mA}$   |                          | 0.25%               | 0.35%          |                     |
|  |  | $10\text{ mA} \leq I_{OUT} \leq 1\text{ A}$   |                          | 3                   | 5              | mV                  |
| $V_{DO}$   | Dropout voltage <sup>(5)</sup><br>( $V_{IN} = V_{OUT(nom)} - 0.1\text{ V}$ ) | $I_{OUT} = 1\text{ A}$  |                          | 130                 | 200            | mV                  |
| $Z_O(\text{DO})$   | Output impedance in dropout  | $2.2\text{ V} \leq V_{IN} \leq V_{OUT} + V_{DO}$  |                          | 0.25                |                | $\Omega$            |
| $I_{CL}$   | Output current limit   | $V_{OUT} = 0.9 \times V_{OUT(nom)}$   | 1.05                     | 1.6                 | 2.2            | A                   |
| $I_{SC}$   | Short-circuit current  | $V_{OUT} = 0\text{ V}$  |                          | 450                 |                | mA                  |
| $I_{REV}$  | Reverse leakage current <sup>(6)</sup> ( $-I_{IN}$ )                         | $V_{EN} \leq 0.5\text{ V}$ , $0\text{ V} \leq V_{IN} \leq V_{OUT}$                                      |                          | 0.1                 |                | $\mu\text{A}$       |
| $I_{GND}$  | GND pin current  | $I_{OUT} = 10\text{ mA}$ ( $I_Q$ )  |                          | 400                 |                | $\mu\text{A}$       |
|  |  | $I_{OUT} = 1\text{ A}$  |                          | 1300                |                |                     |
| $I_{SHDN}$   | Shutdown current ( $I_{GND}$ )   | $V_{EN} \leq 0.5\text{ V}$ , $V_{OUT} \leq V_{IN} \leq 5.5\text{ V}$                                    |                          | 20                  |                | nA                  |
| $I_{FB}$   | FB pin current   | TPS7A3701   |                          | 0.1                 | 0.6            | $\mu\text{A}$       |
| PSRR   | Power-supply rejection ratio (ripple rejection)                              | $f = 100\text{ Hz}$ , $I_{OUT} = 1\text{ A}$  |                          | 58                  |                | dB                  |
|  |  | $f = 10\text{ kHz}$ , $I_{OUT} = 1\text{ A}$  |                          | 37                  |                |                     |
| $V_N$  | Output noise voltage<br>BW = 10 Hz to 100 kHz                                | $C_{OUT} = 10\text{ }\mu\text{F}$   |                          | $27 \times V_{OUT}$ |                | $\mu\text{V}_{RMS}$ |
| $t_{STR}$  | Startup time   | $V_{OUT} = 3\text{ V}$ , $R_L = 30\text{ }\Omega$ , $C_{OUT} = 1\text{ }\mu\text{F}$                    |                          | 600                 |                | $\mu\text{s}$       |
| $V_{EN(HI)}$   | EN pin high (enabled)  |   | 1.7                      |                     | $V_{IN}$       | V                   |
| $V_{EN(LO)}$   | EN pin low (shutdown)  |   | 0                        |                     | 0.5            | V                   |
| $I_{EN(HI)}$   | EN pin current (enabled)   | $V_{EN} = 5.5\text{ V}$   |                          | 20                  |                | nA                  |
| $T_{SD}$   | Thermal shutdown temperature   | Shutdown, temperature increasing  |                          | 160                 |                | $^\circ\text{C}$    |
|  |  | Reset, temperature decreasing   |                          | 140                 |                |                     |
| $T_J$  | Operating junction temperature   |   | -40                      |                     | 125            | $^\circ\text{C}$    |

(1) Minimum  $V_{IN} = V_{OUT} + V_{DO}$  or 2.2 V, whichever is greater.

(2) For  $V_{OUT(nom)} < 1.6\text{ V}$ , when  $V_{IN} \leq 1.6\text{ V}$ , the output will lock to  $V_{IN}$  and may result in an over-voltage condition on the output. To avoid this situation, disable the device before powering down  $V_{IN}$ .

(3) TPS7A3701 is tested at  $V_{OUT} = 1.2\text{ V}$ .

(4) Tolerance of external resistors not included in this specification.

(5)  $V_{DO}$  is not measured for fixed output versions with  $V_{OUT(nom)} < 2.3\text{ V}$  since minimum  $V_{IN} = 2.2\text{ V}$ .

(6) Fixed-voltage versions only; refer to the [Application Information](#) section for more information.

### 6.6 Typical Characteristics

For all voltage versions at  $T_J = 25^\circ\text{C}$ ,  $V_{IN} = V_{OUT(nom)} + 1\text{ V}$ ,  $I_{OUT} = 10\text{ mA}$ ,  $V_{EN} = 2.2\text{ V}$ , and  $C_{OUT} = 2.2\text{ }\mu\text{F}$ , unless otherwise noted.

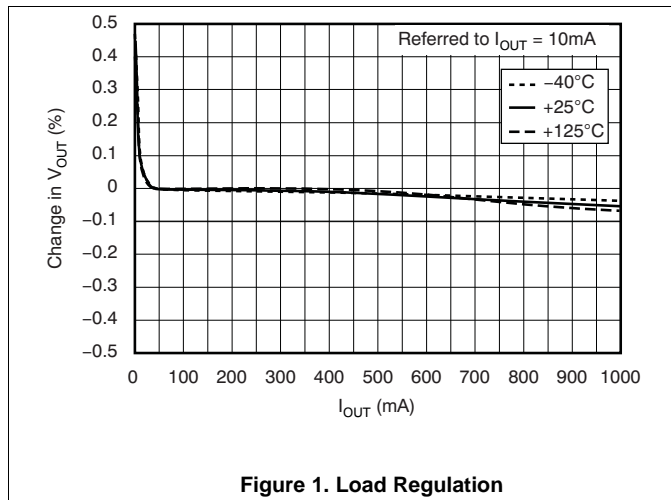

Figure 1. Load Regulation

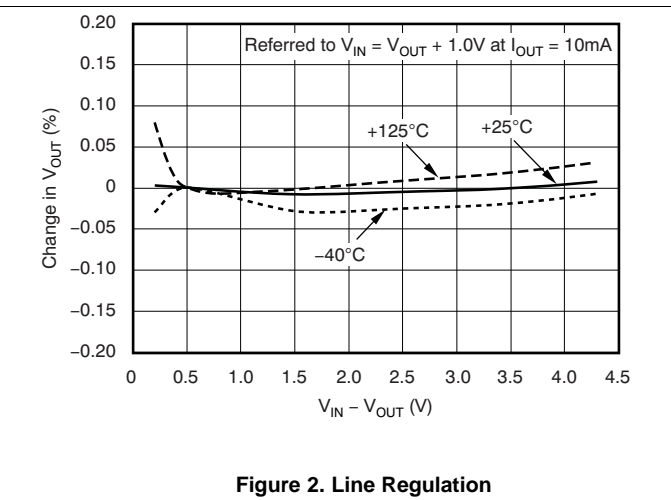

Figure 2. Line Regulation

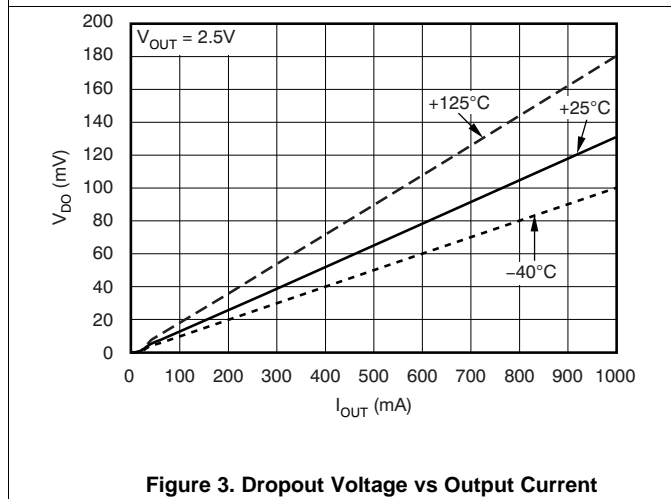

Figure 3. Dropout Voltage vs Output Current

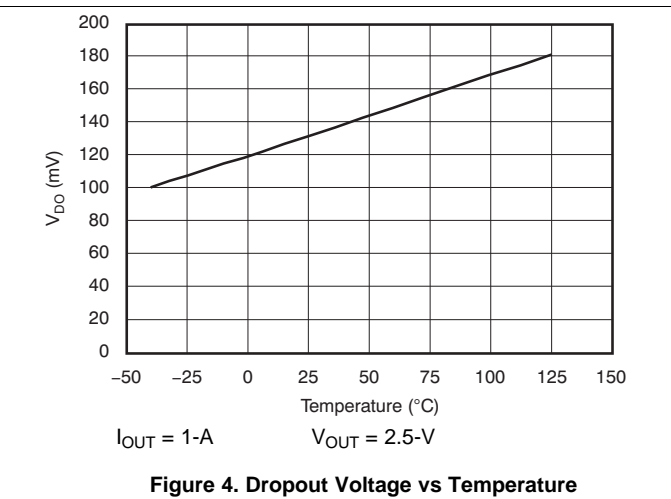

Figure 4. Dropout Voltage vs Temperature

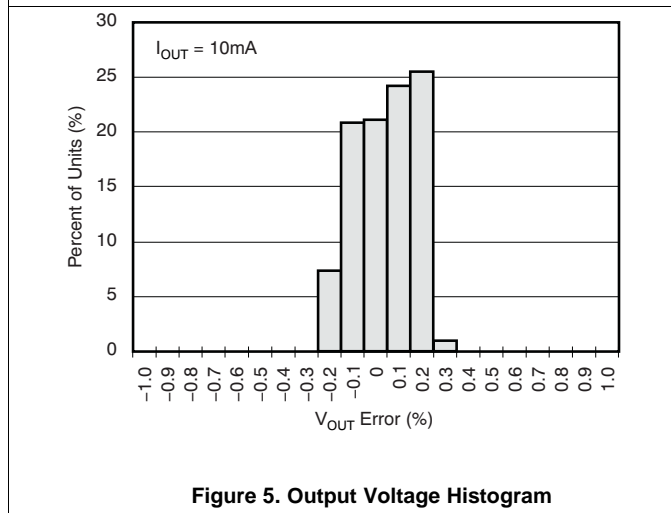

Figure 5. Output Voltage Histogram

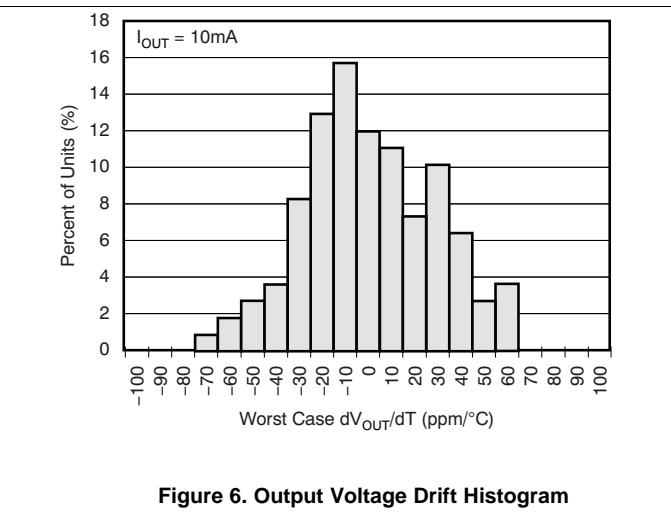

Figure 6. Output Voltage Drift Histogram

Typical Characteristics (continued)

For all voltage versions at  $T_J = 25^\circ\text{C}$ ,  $V_{IN} = V_{OUT(nom)} + 1\text{ V}$ ,  $I_{OUT} = 10\text{ mA}$ ,  $V_{EN} = 2.2\text{ V}$ , and  $C_{OUT} = 2.2\text{ }\mu\text{F}$ , unless otherwise noted.

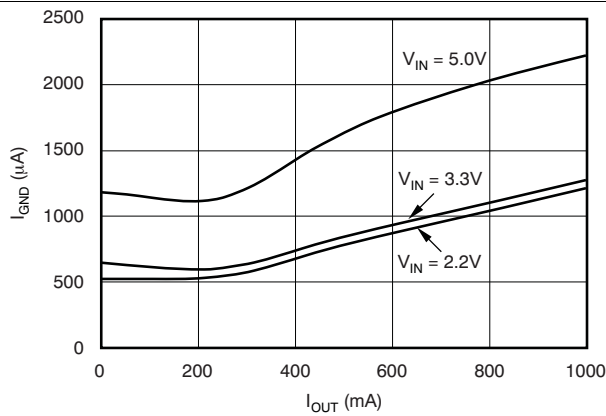

Figure 7. Ground Pin Current vs Output Current

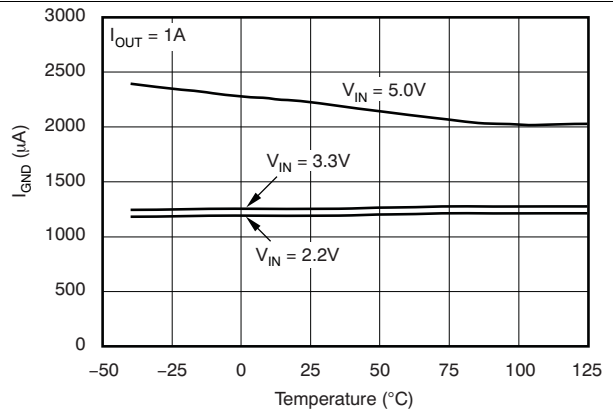

Figure 8. Ground Pin Current vs Temperature

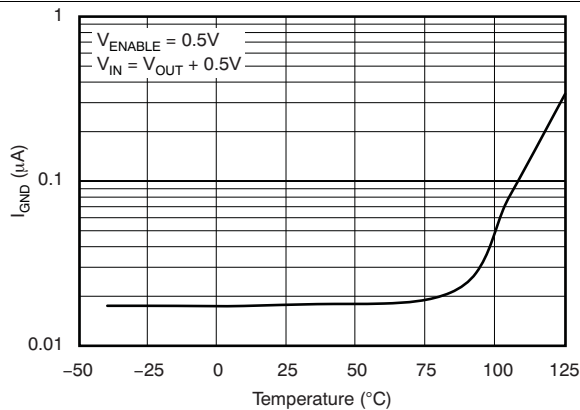

Figure 9. Ground Pin Current in Shutdown vs Temperature

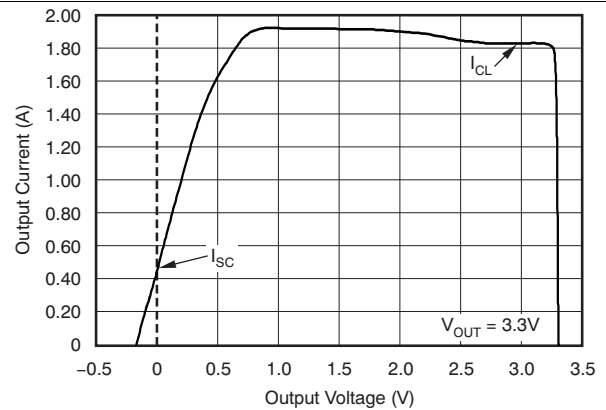

Figure 10. Current Limit vs  $V_{OUT}$  (Foldback)

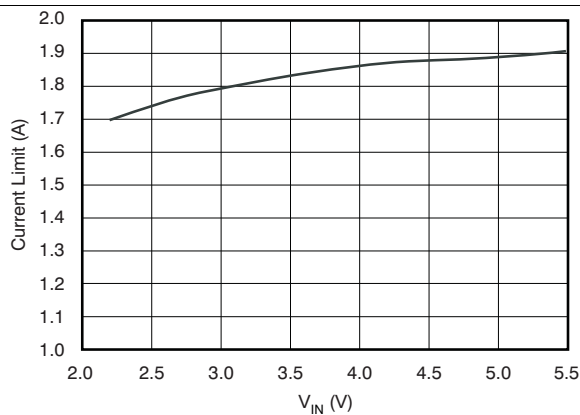

Figure 11. Current Limit vs  $V_{IN}$

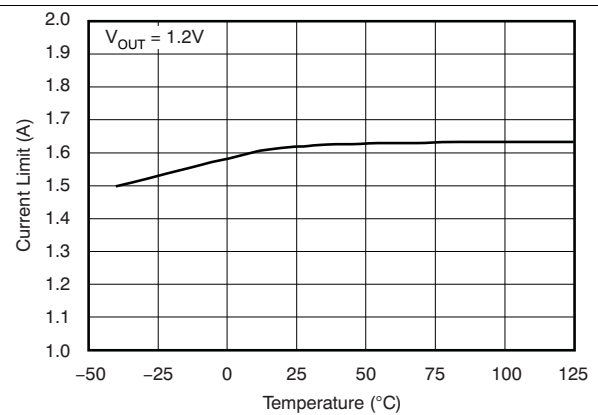

Figure 12. Current Limit vs Temperature

### Typical Characteristics (continued)

For all voltage versions at  $T_J = 25^\circ\text{C}$ ,  $V_{IN} = V_{OUT(nom)} + 1\text{ V}$ ,  $I_{OUT} = 10\text{ mA}$ ,  $V_{EN} = 2.2\text{ V}$ , and  $C_{OUT} = 2.2\text{ }\mu\text{F}$ , unless otherwise noted.

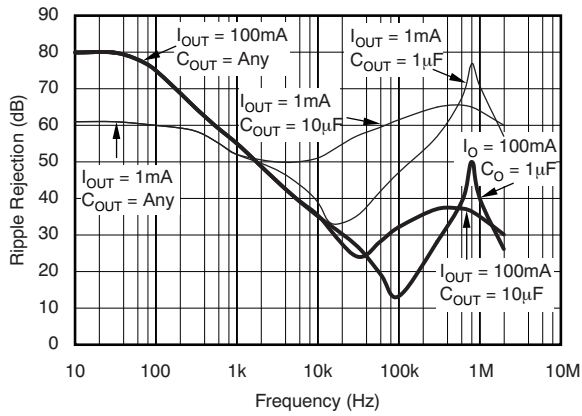

Figure 13. PSRR (Ripple Rejection) vs Frequency

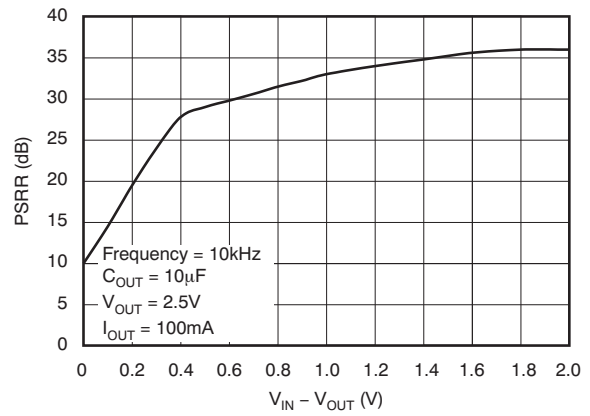

Figure 14. PSRR (Ripple Rejection) vs  $V_{IN} - V_{OUT}$

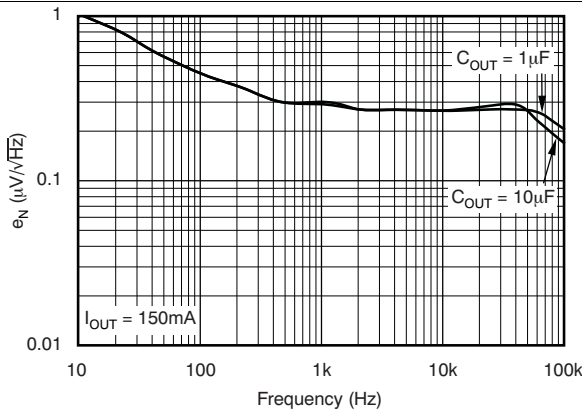

Figure 15. Noise Spectral Density

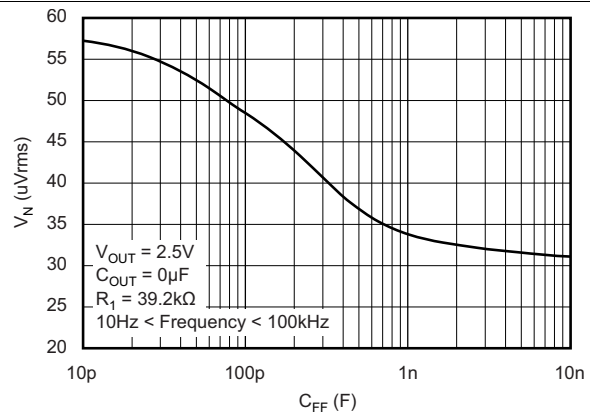

Figure 16. TPS7A3701: RMS Noise Voltage vs  $C_{FF}$

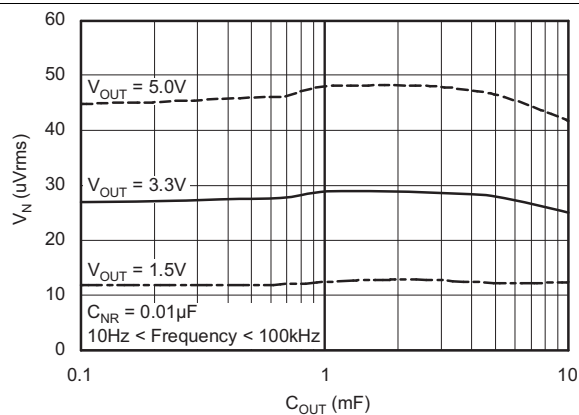

Figure 17. RMS Noise Voltage vs  $C_{OUT}$

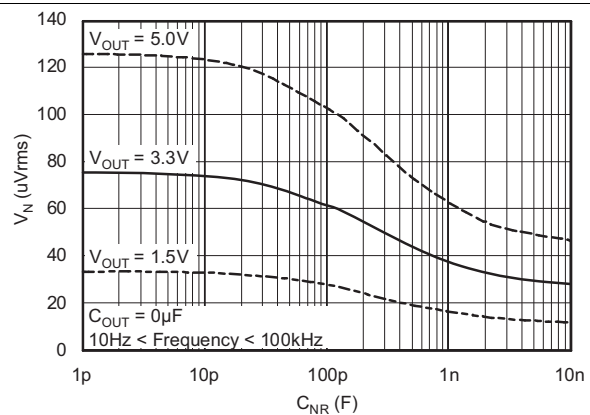
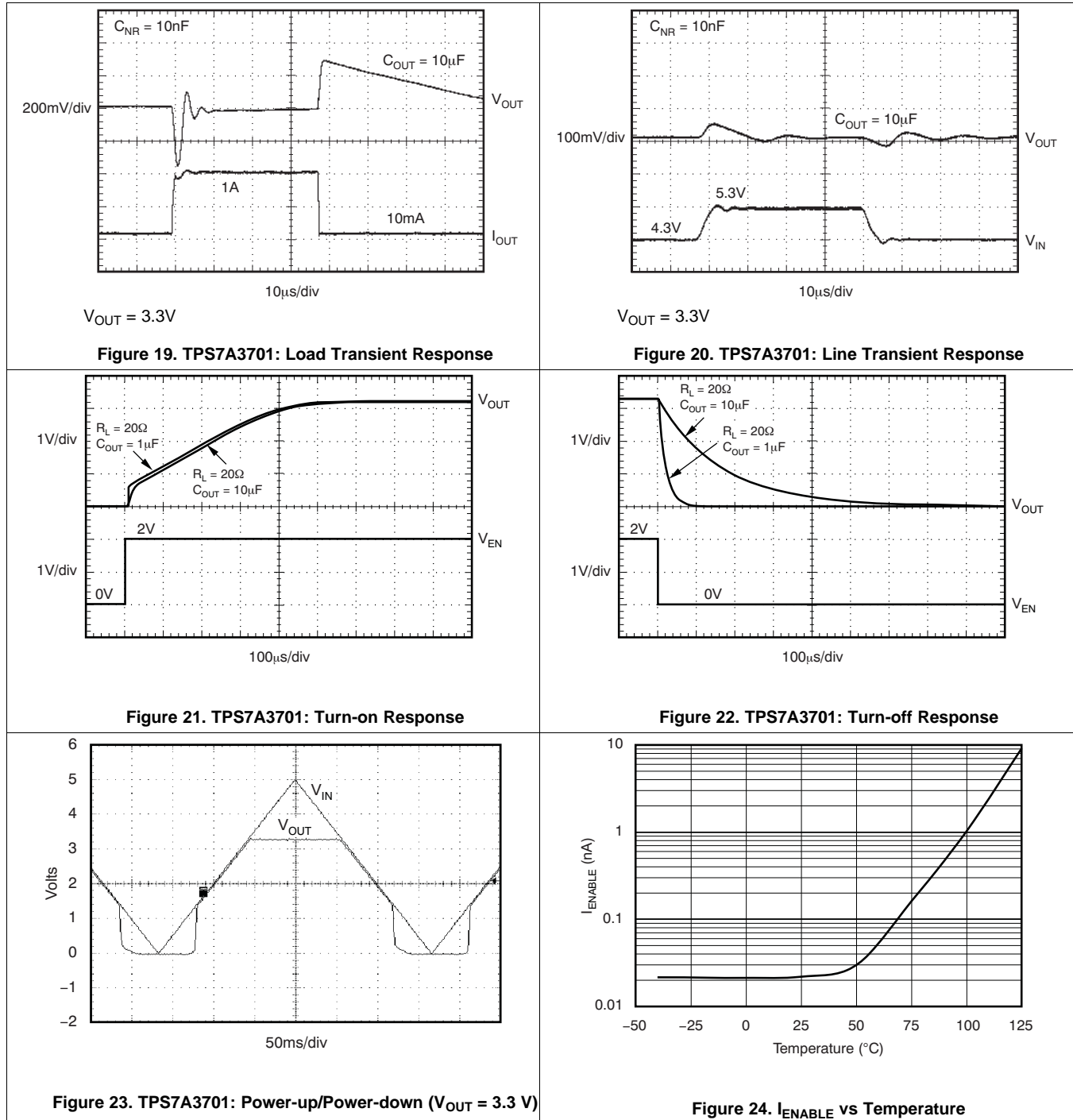

Figure 18. RMS Noise Voltage vs  $C_{NR}$



Typical Characteristics (continued)

For all voltage versions at  $T_J = 25^\circ\text{C}$ ,  $V_{IN} = V_{OUT(nom)} + 1\text{ V}$ ,  $I_{OUT} = 10\text{ mA}$ ,  $V_{EN} = 2.2\text{ V}$ , and  $C_{OUT} = 2.2\text{ }\mu\text{F}$ , unless otherwise noted.



### Typical Characteristics (continued)

For all voltage versions at  $T_J = 25^\circ\text{C}$ ,  $V_{IN} = V_{OUT(nom)} + 1\text{ V}$ ,  $I_{OUT} = 10\text{ mA}$ ,  $V_{EN} = 2.2\text{ V}$ , and  $C_{OUT} = 2.2\text{ }\mu\text{F}$ , unless otherwise noted.

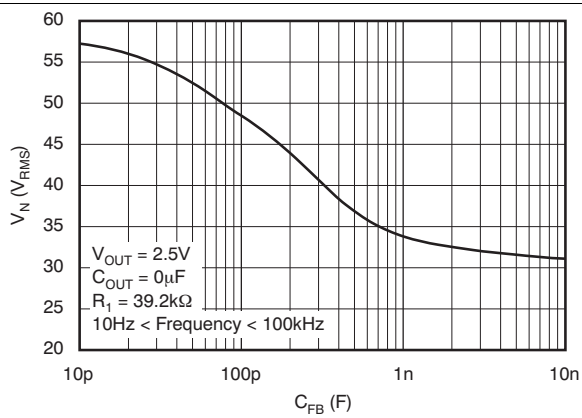

Figure 25. TPS7A3701: RMS Noise Voltage vs  $C_{FB}$

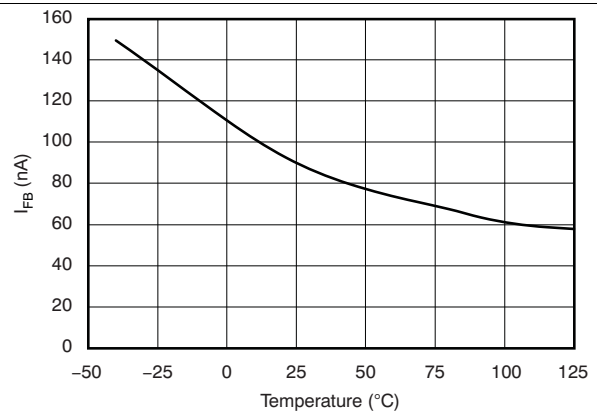

Figure 26. TPS7A3701:  $I_{FB}$  vs Temperature

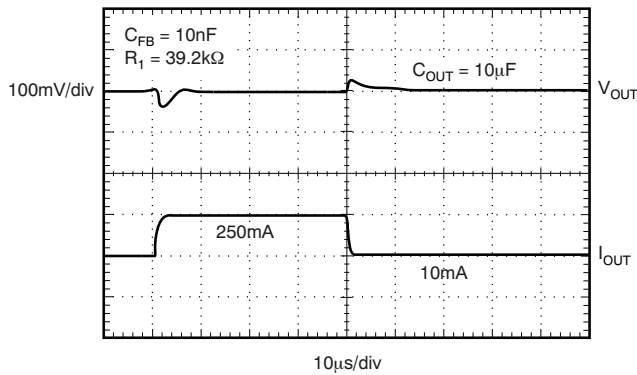

Figure 27. TPS7A3701: Load Transient, Adjustable Version

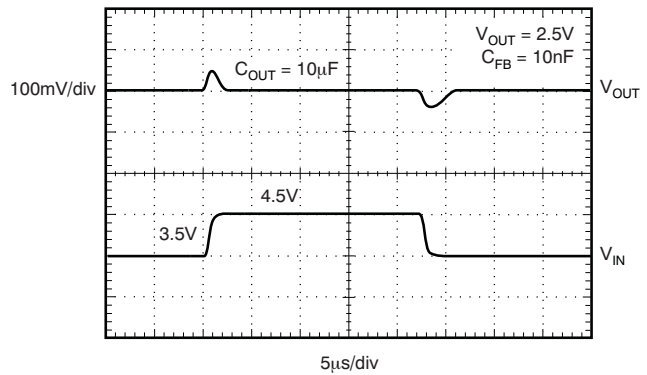

Figure 28. TPS7A3701: Line Transient, Adjustable Version

## 7 Detailed Description

### 7.1 Overview

The TPS7A37 belongs to a family of LDO regulators that use an NMOS pass transistor to achieve ultra-low-dropout performance and reverse current protection. These features combined with an enable input make the TPS7A37 ideal for portable applications. This regulator family offers a wide selection of fixed output voltage versions and an adjustable output version. All versions have thermal and over-current protection, including foldback current limit.

### 7.2 Functional Block Diagrams

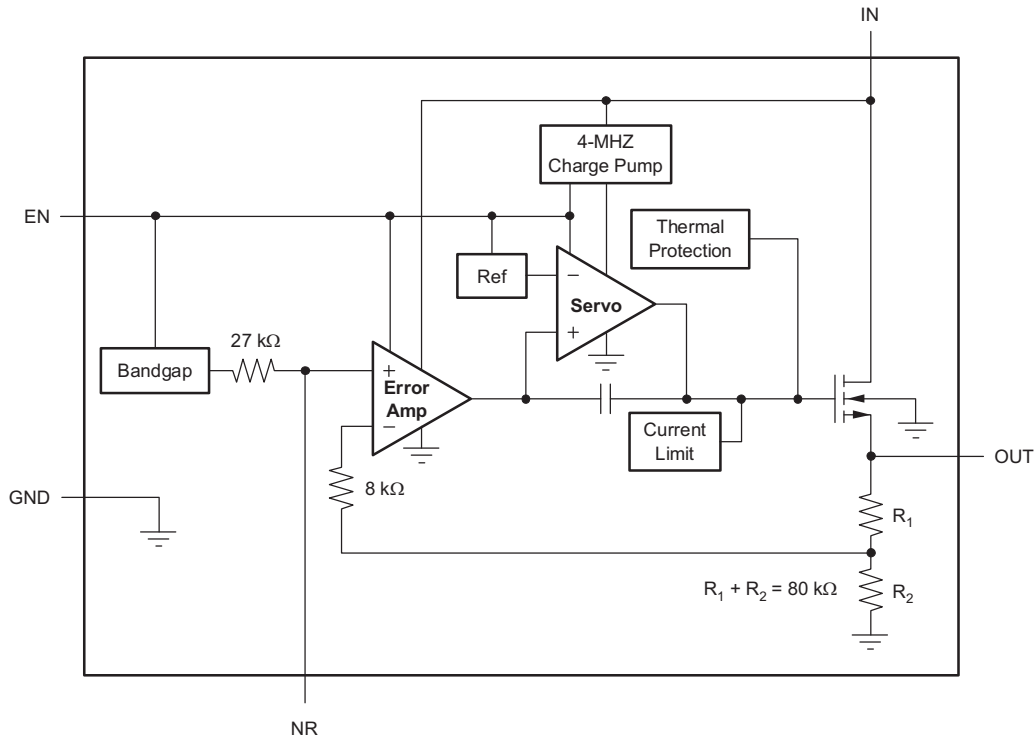
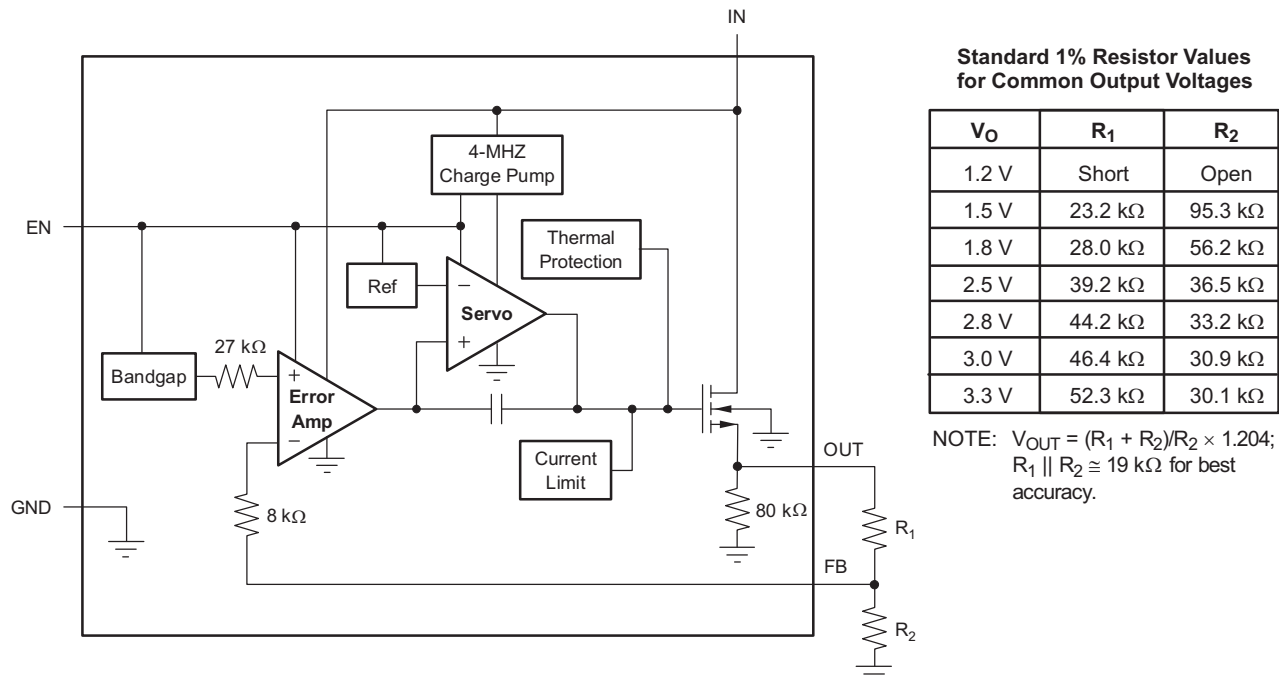

Figure 29. Fixed Voltage Version

**Functional Block Diagrams (continued)**

**Figure 30. Adjustable Voltage Version**

### 7.3 Feature Description

#### 7.3.1 Internal Current Limit

The TPS7A37 internal current limit helps protect the regulator during fault conditions. Foldback current limit helps to protect the regulator from damage during output short-circuit conditions by reducing current limit when  $V_{OUT}$  drops below 0.5 V. See [Figure 10](#) in the *Typical Characteristics* section.

Note from [Figure 10](#) that approximately  $-0.2 \text{ V}$  of  $V_{OUT}$  results in a current limit of 0 mA. Therefore, if OUT is forced below  $-0.2 \text{ V}$  before EN goes high, the device may not start up. In applications that work with both a positive and negative voltage supply, the TPS7A37 should be enabled first.

#### 7.3.2 Enable Pin and Shutdown

The enable pin (EN) is active high and is compatible with standard TTL-CMOS levels. A  $V_{EN}$  below 0.5 V (max) turns the regulator off and drops the GND pin current to approximately 10 nA. When EN is used to shutdown the regulator, all charge is removed from the pass transistor gate, and the output ramps back up to a regulated  $V_{OUT}$  (see [Figure 21](#)).

When shutdown capability is not required, EN can be connected to  $V_{IN}$ . However, the pass gate may not be discharged using this configuration, and the pass transistor may be left on (enhanced) for a significant time after  $V_{IN}$  has been removed. This scenario can result in reverse current flow (if the IN pin is low impedance) and faster ramp times upon power-up. In addition, for  $V_{IN}$  ramp times slower than a few milliseconds, the output may overshoot upon power-up.

Note that current limit foldback can prevent device start-up under some conditions. See the [Internal Current Limit](#) section for more information.

## Feature Description (continued)

### 7.3.3 Reverse Current

The NMOS pass element of the TPS7A37 provides inherent protection against current flow from the output of the regulator to the input when the gate of the pass device is pulled low. To ensure that all charge is removed from the gate of the pass element, the EN pin must be driven low before the input voltage is removed. If this is not done, the pass element may be left on because of stored charge on the gate.

After the EN pin is driven low, no bias voltage is needed on any pin for reverse current blocking. Note that reverse current is specified as the current flowing out of the IN pin because of voltage applied on the OUT pin. There will be additional current flowing into the OUT pin as a result of the 80-k $\Omega$  internal resistor divider to ground (see [Figure 29](#) and [Figure 30](#)).

For the TPS7A3701, reverse current may flow when  $V_{FB}$  is more than 1.0 V above  $V_{IN}$ .

## 7.4 Device Functional Modes

Driving the EN pin over 1.7 V turns on the regulator. Driving the EN pin below 0.5 V causes the regulator to enter shutdown mode. In shutdown, the current consumption of the device is reduced to 20 nA, typically.

## 8 Application and Implementation

### NOTE

Information in the following applications sections is not part of the TI component specification, and TI does not warrant its accuracy or completeness. TI's customers are responsible for determining suitability of components for their purposes. Customers should validate and test their design implementation to confirm system functionality.

### 8.1 Application Information

#### 8.1.1 Input and Output Capacitor Requirements

Although an input capacitor is not required for stability if input impedance is very low, it is good analog design practice to connect a 0.1- $\mu$ F to 1- $\mu$ F low equivalent series resistance (ESR) capacitor across the input supply near the regulator. This capacitor counteracts reactive input sources and improves transient response, noise rejection, and ripple rejection. A higher-value capacitor may be necessary if large, fast rise-time load transients are anticipated or the device is located several inches from the power source.

The TPS7A37 requires a 1- $\mu$ F output capacitor for stability. It is designed to be stable for all available types and values of capacitors. In applications where multiple low ESR capacitors are in parallel, ringing may occur when  $C_{OUT} \times ESR < 50$  n $\Omega$ -F. Total ESR includes all parasitic resistances, including capacitor ESR and board, socket, and solder joint resistance. In most applications, the sum of capacitor ESR and trace resistance will meet this requirement.

#### 8.1.2 Output Noise

A precision bandgap reference is used to generate the internal reference voltage,  $V_{REF}$ . This reference is the dominant noise source within the TPS7A37 and it generates approximately 32  $\mu$ V<sub>RMS</sub> (10 Hz to 100 kHz) at the reference output (NR). The regulator control loop gains up the reference noise with the same gain as the reference voltage, so that the noise voltage of the regulator is approximately given by:

$$V_N = 32\mu V_{RMS} \times \frac{(R_1 + R_2)}{R_2} = 32\mu V_{RMS} \times \frac{V_{OUT}}{V_{REF}} \quad (1)$$

Since the value of  $V_{REF}$  is 1.2V, this relationship reduces to:

$$V_N(\mu V_{RMS}) = 27 \left( \frac{\mu V_{RMS}}{V} \right) \times V_{OUT}(V) \quad (2)$$

for the case of no  $C_{NR}$ .

An internal 27-k $\Omega$  resistor in series with the noise reduction pin (NR) forms a low-pass filter for the voltage reference when an external noise reduction capacitor,  $C_{NR}$ , is connected from NR to ground. For  $C_{NR} = 10$  nF, the total noise in the 10-Hz to 100-kHz bandwidth is reduced by a factor of ~3.2, giving the approximate relationship:

$$V_N(\mu V_{RMS}) = 8.5 \left( \frac{\mu V_{RMS}}{V} \right) \times V_{OUT}(V) \quad (3)$$

for  $C_{NR} = 10$  nF.

This noise reduction effect is shown as RMS Noise Voltage vs  $C_{NR}$  in the [Typical Characteristics](#) section.

The TPS7A3701 adjustable version does not have the NR pin available. However, connecting a feedback capacitor,  $C_{FB}$ , from the output to the feedback pin (FB) reduces output noise and improve load transient performance. This capacitor should be limited to 0.1  $\mu$ F.

The TPS7A37 uses an internal charge pump to develop an internal supply voltage sufficient to drive the gate of the NMOS pass element above  $V_{OUT}$ . The charge pump generates ~250  $\mu$ V of switching noise at ~4 MHz; however, charge-pump noise contribution is negligible at the output of the regulator for most values of  $I_{OUT}$  and  $C_{OUT}$ .

## Application Information (continued)

### 8.1.3 Dropout Voltage

The TPS7A37 uses an NMOS pass transistor to achieve extremely low dropout. When  $(V_{IN} - V_{OUT})$  is less than the dropout voltage ( $V_{DO}$ ), the NMOS pass device is in its linear region of operation and the input-to-output resistance is the  $R_{DS, ON}$  of the NMOS pass element.

For large step changes in load current, the TPS7A37 requires a larger voltage drop from  $V_{IN}$  to  $V_{OUT}$  to avoid degraded transient response. The boundary of this transient dropout region is approximately twice the dc dropout. Values of  $V_{IN} - V_{OUT}$  above this line ensure normal transient response.

Operating in the transient dropout region can cause an increase in recovery time. The time required to recover from a load transient is a function of the magnitude of the change in load current rate, the rate of change in load current, and the available headroom ( $V_{IN}$  to  $V_{OUT}$  voltage drop). Under worst-case conditions [full-scale instantaneous load change with  $(V_{IN} - V_{OUT})$  close to dc dropout levels], the TPS7A37 can take a couple of hundred microseconds to return to the specified regulation accuracy.

### 8.1.4 Transient Response

The low open-loop output impedance provided by the NMOS pass element in a voltage follower configuration allows operation without a 1.0- $\mu$ F output capacitor. As with any regulator, the addition of additional capacitance from the OUT pin to ground reduces undershoot magnitude but increases its duration. In the adjustable version, the addition of a capacitor,  $C_{FB}$ , from the OUT pin to the FB pin will also improve the transient response.

The TPS7A37 does not have active pull-down when the output is over-voltage. This architecture allows applications that connect higher voltage sources, such as alternate power supplies, to the output. This architecture also results in an output overshoot of several percent if the load current quickly drops to zero when a capacitor is connected to the output. The duration of overshoot can be reduced by adding a load resistor. The overshoot decays at a rate determined by output capacitor  $C_{OUT}$  and the internal/external load resistance. The rate of decay is given by:

(Fixed voltage version)

$$\frac{dV}{dT} = \frac{V_{OUT}}{C_{OUT} \times 80k\Omega \parallel R_{LOAD}} \quad (4)$$

(Adjustable voltage version)

$$\frac{dV}{dT} = \frac{V_{OUT}}{C_{OUT} \times 80k\Omega \parallel (R_1 + R_2) \parallel R_{LOAD}} \quad (5)$$

## 8.2 Typical Applications

### 8.2.1 Typical Application Schematic

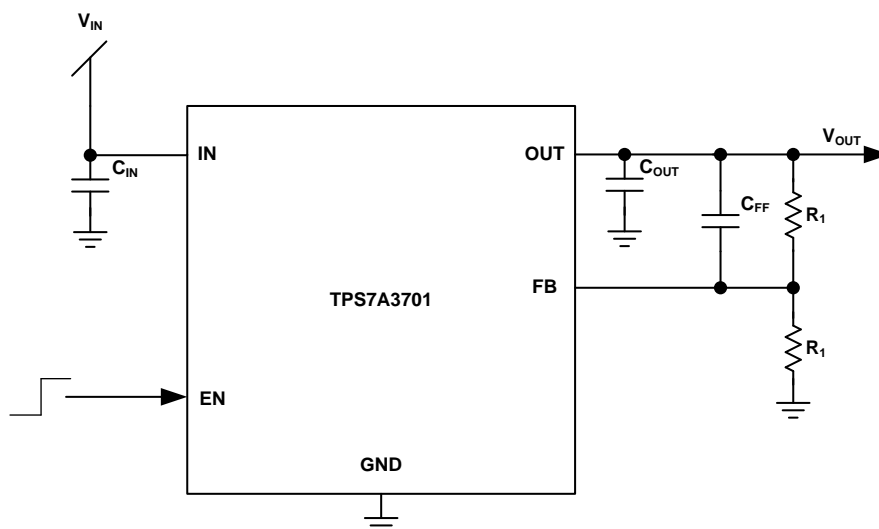

**Figure 31. Typical Application Schematic**

#### 8.2.1.1 Design Requirements

Table 1 lists the design parameters.

**Table 1. Design Parameters**

| DESIGN PARAMETER    | EXAMPLE VALUE |
|---------------------|---------------|
| Input voltage       | 3.6 V         |
| Output voltage      | 3.3 V         |
| DC output current   | 100 mA        |
| Peak output current | 1 A           |

#### 8.2.1.2 Detailed Design Procedure

Due to the transients in this application input and output capacitors should be used. A  $C_{IN} = C_{OUT} = 10\text{-}\mu\text{F}$  capacitor has been selected.

The ESR of the chosen capacitor can be checked by looking the magnitude of the complex impedance over frequency. When  $|Z_c|$  reaches a minimum the DC ESR is the value of  $|Z_c|$  at that frequency. The ESR of the chosen capacitor is  $10\text{ m}\Omega$ , which gives us a product of  $10\text{ m}\Omega \times 10\text{ }\mu\text{F} = 100\text{ n}\Omega\text{-F} > 50\text{ n}\Omega\text{-F}$ , minimizing the ringing during transients.

As the  $V_{IN} - V_{OUT}$  change is only 300 mV with a 100-mA DC current, the expected junction temperature rise over the ambient, on a JEDEC standard board, is  $67.2\text{ C/W} \times 0.3\text{ V} \times 0.1\text{ A} = 2\text{ C}$ .

To ensure best accuracy,  $R_1 = 52.3\text{ k}\Omega$  and  $R_2 = 30.1\text{ k}\Omega$ , and a  $10\text{-nF } C_{FF}$  is used to reduce output noise.



8.2.1.3 Application Curves

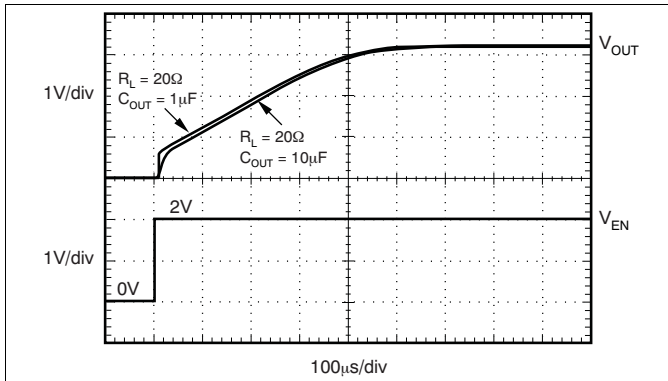

Figure 32. TPS7A3701: Turn-on Response

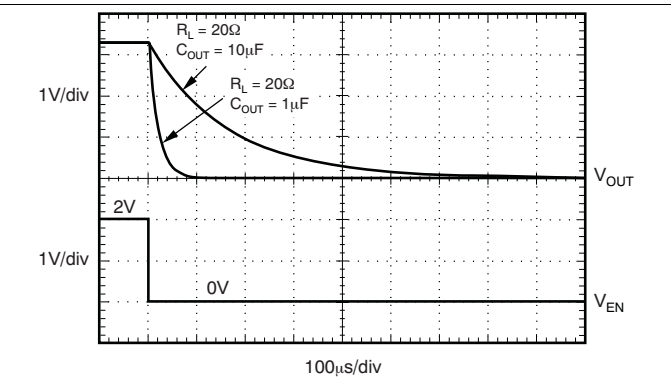

Figure 33. TPS7A3701: Turn-off Response

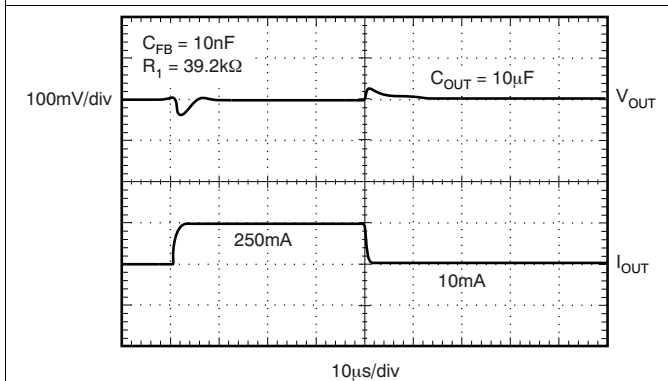

Figure 34. TPS7A3701: Load Transient, Adjustable Version

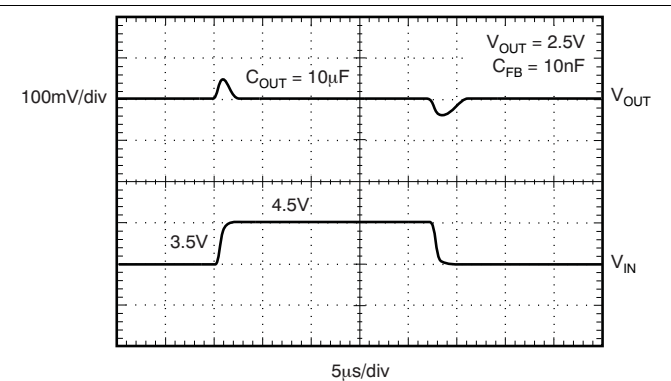
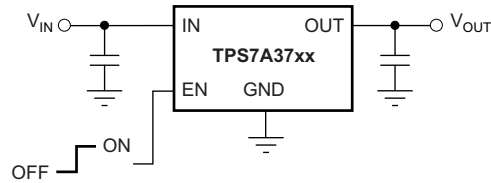

Figure 35. TPS7A3701: Line Transient, Adjustable Version

### 8.2.2 Fixed-Voltage Version

Figure 36 shows the basic circuit connections for the fixed voltage models.



**Figure 36. Typical Application Circuit for Fixed-Voltage Version**

### 8.2.3 Adjustable Operation

Figure 37 gives the connections for the adjustable output version, TPS7A3701 .

$R_1$  and  $R_2$  can be calculated for any output voltage using the formula shown in Figure 37. Sample resistor values for common output voltages are shown in Figure 30.

For best accuracy, make the parallel combination of  $R_1$  and  $R_2$  approximately equal to 19 k $\Omega$ . This 19 k $\Omega$ , in addition to the internal 8-k $\Omega$  resistor, presents the same impedance to the error amp as the 27-k $\Omega$  bandgap reference output. This impedance helps compensate for leakages into the error amp terminals.

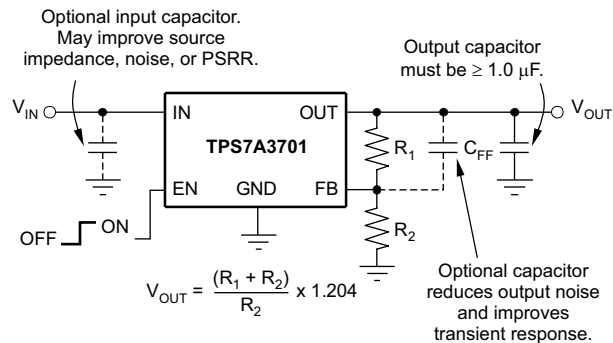

**Figure 37. Typical Application Circuit for Adjustable-Voltage Version<sup>(1)</sup>**

## 9 Power Supply Recommendations

The input supply for the LDO must be within its recommended operating conditions (that is, between 2.2 V to 5.5 V). The input voltage must provide adequate headroom in order for the device to have a regulated output. If the input supply is noisy, additional input capacitors with low ESR can help improve the output transient performance.

## 10 Layout

### 10.1 Layout Guidelines

Layout is a critical part of good power-supply design. There are several signal paths that conduct fast-changing currents or voltages that can interact with stray inductance or parasitic capacitance to generate noise or degrade the power-supply performance. To help eliminate these problems, the IN pin should be bypassed to ground with a low ESR ceramic bypass capacitor with an X5R or X7R dielectric.

The GND pin should be tied directly to the PowerPAD under the IC. The PowerPAD should be connected to any internal PCB ground planes using multiple vias directly under the IC.

Do not place any of the capacitors on the opposite side of the PCB from where the regulator is installed. The use of vias and long traces is strongly discouraged because these circuits may impact system performance negatively, and even cause instability.

#### 10.1.1 Board Layout Recommendations to Improve PSRR and Noise Performance

To improve AC performance (such as PSRR, output noise, and transient response), TI recommends designing the board with separate ground planes for  $V_{IN}$  and  $V_{OUT}$ , with each ground plane star connected only at the GND pin of the device.

### 10.2 Layout Example

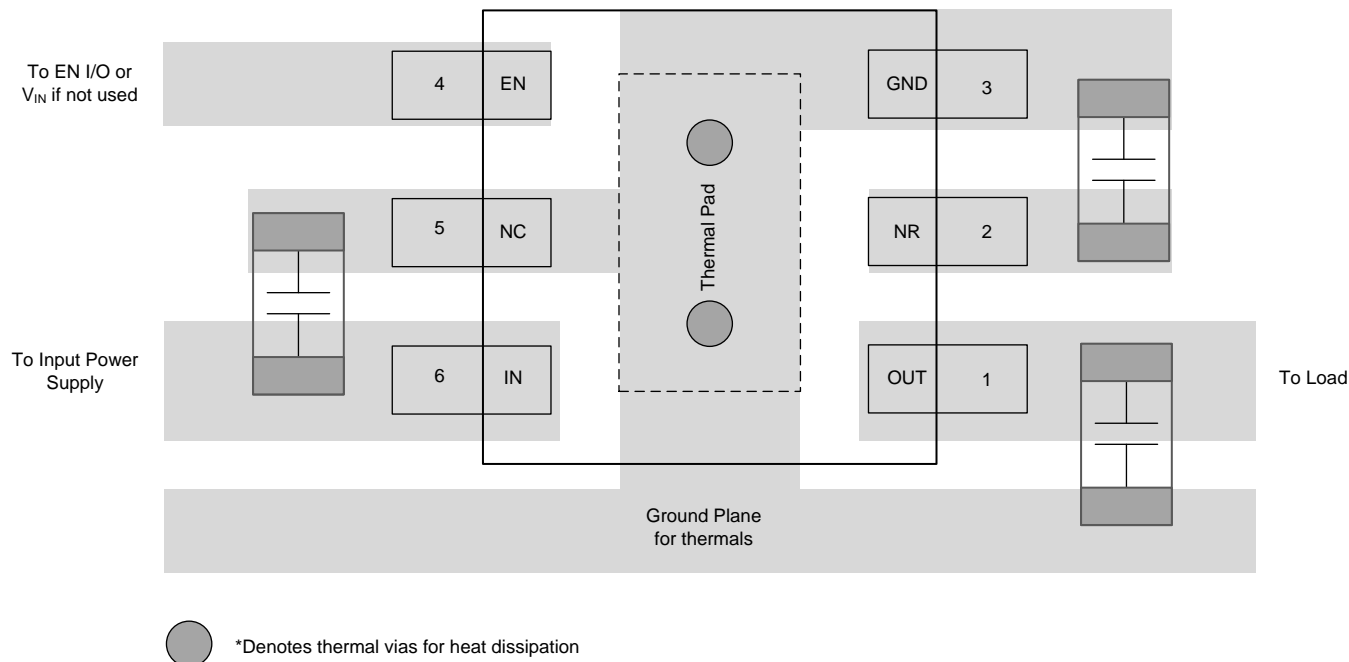
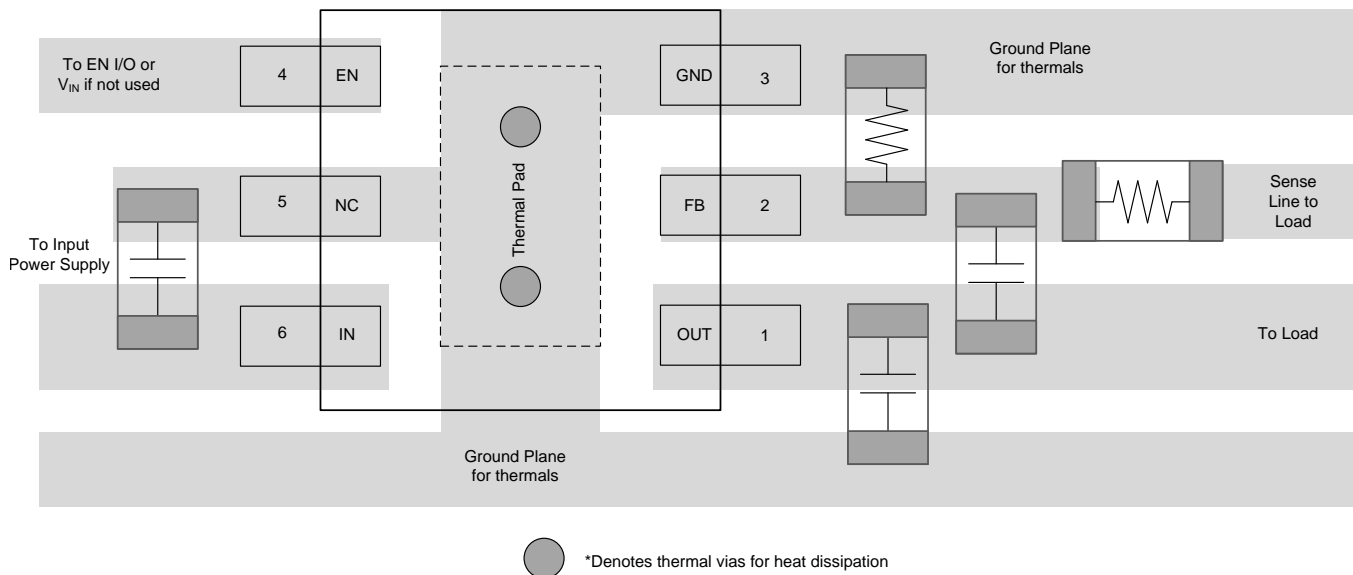

Figure 38. Fixed Voltage Layout

## Layout Example (continued)



**Figure 39. Adjustable Voltage Layout**

### 10.3 Thermal Considerations

Thermal protection disables the output when the junction temperature rises to approximately +160°C, allowing the device to cool. When the junction temperature cools to approximately +140°C, the output circuitry is again enabled. Depending on power dissipation, thermal resistance, and ambient temperature, the thermal protection circuit may cycle on and off. This cycling limits the dissipation of the regulator, protecting it from damage due to overheating.

Any tendency to activate the thermal protection circuit indicates excessive power dissipation or an inadequate heatsink. For reliable operation, junction temperature should be limited to +125°C maximum. To estimate the margin of safety in a complete design (including heatsink), increase the ambient temperature until the thermal protection is triggered; use worst-case loads and signal conditions. For good reliability, thermal protection should trigger at least +35°C above the maximum expected ambient condition of your application. This produces a worst-case junction temperature of +125°C at the highest expected ambient temperature and worst-case load.

The internal protection circuitry of the TPS7A37 has been designed to protect against overload conditions. It was not intended to replace proper heatsinking. Continuously running the TPS7A37 into thermal shutdown degrades device reliability.

### 10.4 Power Dissipation

Knowing the device power dissipation and proper sizing of the thermal plane that is connected to the tab or pad is critical to avoiding thermal shutdown and ensuring reliable operation.

Power dissipation of the device depends on input voltage and load conditions and can be calculated using [Equation 6](#):

$$P_D = (V_{IN} - V_{OUT}) \times I_{OUT} \quad (6)$$

Power dissipation can be minimized and greater efficiency can be achieved by using the lowest possible input voltage necessary to achieve the required output voltage regulation.

## Power Dissipation (continued)

On the WSON (DRV) package, the primary conduction path for heat is through the exposed pad to the printed circuit board (PCB). The pad can be connected to ground or be left floating; however, it should be attached to an appropriate amount of copper PCB area to ensure the device does not overheat. That tab should be connected to ground. The maximum junction-to-ambient thermal resistance depends on the maximum ambient temperature, maximum device junction temperature, and power dissipation of the device and can be calculated using Equation 7:

$$R_{\theta JA} = \frac{(+125^{\circ}\text{C} - T_A)}{P_D} \quad (7)$$

Knowing the maximum  $R_{\theta JA}$ , the minimum amount of PCB copper area needed for appropriate heatsinking can be estimated using Figure 40.

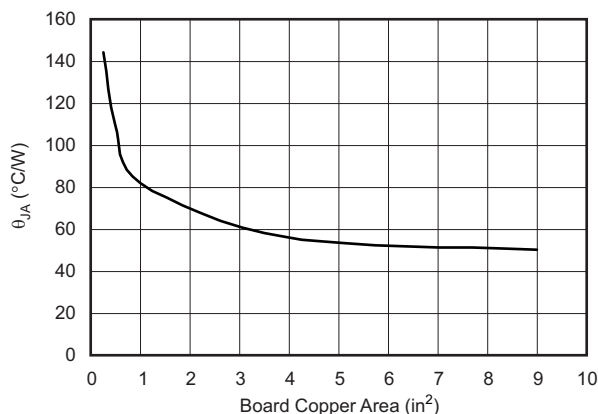

Note:  $\theta_{JA}$  value at board size of 9in<sup>2</sup> (that is, 3in × 3in) is a JEDEC standard.

**Figure 40. DRV (WSON) Package  $\theta_{JA}$  vs Board Size**

Figure 40 shows the variation of  $\theta_{JA}$  as a function of ground plane copper area in the board. It is intended only as a guideline to demonstrate the effects of heat spreading in the ground plane and should not be used to estimate actual thermal performance in real application environments.

### NOTE

When the device is mounted on an application PCB, it is strongly recommended to use  $\Psi_{JT}$  and  $\Psi_{JB}$ , as explained in the [Estimating Junction Temperature](#) section.

## 10.5 Estimating Junction Temperature

Using the thermal metrics  $\Psi_{JT}$  and  $\Psi_{JB}$ , as shown in the [Thermal Information](#) table, the junction temperature can be estimated with corresponding formulas (given in Equation 8). For backwards compatibility, an older  $\theta_{JC, Top}$  parameter is listed as well.

$$\begin{aligned} \Psi_{JT}: \quad T_J &= T_T + \Psi_{JT} \cdot P_D \\ \Psi_{JB}: \quad T_J &= T_B + \Psi_{JB} \cdot P_D \end{aligned} \quad (8)$$

Where  $P_D$  is the power dissipation shown by Equation 6,  $T_T$  is the temperature at the center-top of the IC package, and  $T_B$  is the PCB temperature measured 1mm away from the IC package *on the PCB surface* (as Figure 42 shows).

### NOTE

Both  $T_T$  and  $T_B$  can be measured on actual application boards using a thermo-gun (an infrared thermometer).

### Estimating Junction Temperature (continued)

For more information about measuring  $T_T$  and  $T_B$ , see the application note [SBVA025](#), *Using New Thermal Metrics*, available for download at [www.ti.com](#).

By looking at [Figure 41](#), the new thermal metrics ( $\Psi_{JT}$  and  $\Psi_{JB}$ ) have very little dependency on board size. That is, using  $\Psi_{JT}$  or  $\Psi_{JB}$  with [Equation 8](#) is a good way to estimate  $T_J$  by simply measuring  $T_T$  or  $T_B$ , regardless of the application board size.

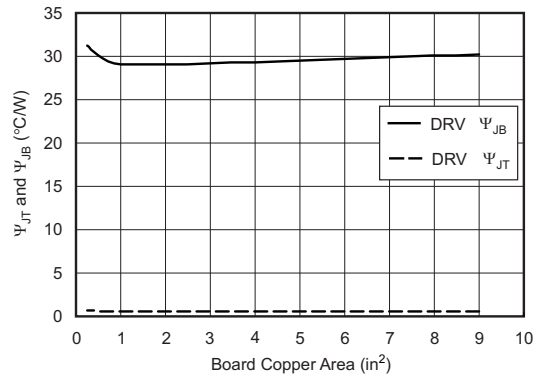

**Figure 41. DRV (WSON) Package  $\Psi_{JT}$  and  $\Psi_{JB}$  vs Board Size**

For a more detailed discussion of why TI does not recommend using  $\theta_{JC(top)}$  to determine thermal characteristics, refer to application report [SBVA025](#), *Using New Thermal Metrics*, available for download at [www.ti.com](#). For further information, refer to application report [SPRA953](#), *Semiconductor and IC Package Thermal Metrics*, also available on the TI website.

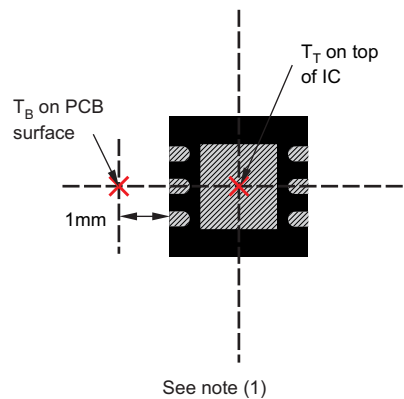

- (1) Power dissipation may limit operating range. Check [Thermal Information](#) table.
- (2) Example DRV (SON) Package Measurement

**Figure 42. Measuring Points for  $T_T$  and  $T_B$**

## 11 Device and Documentation Support

### 11.1 Documentation Support

#### 11.1.1 Related Documentation

- *Using New Thermal Metrics*, [SBVA025](#)
- *TPS7A37xxEVM-529 Evaluation Module*, [SLVU850](#)

#### 11.1.2 Community Resources

The following links connect to TI community resources. Linked contents are provided "AS IS" by the respective contributors. They do not constitute TI specifications and do not necessarily reflect TI's views; see TI's [Terms of Use](#).

**TI E2E™ Online Community** *TI's Engineer-to-Engineer (E2E) Community*. Created to foster collaboration among engineers. At [e2e.ti.com](#), you can ask questions, share knowledge, explore ideas and help solve problems with fellow engineers.

**Design Support** *TI's Design Support* Quickly find helpful E2E forums along with design support tools and contact information for technical support.

### 11.2 Trademarks

E2E is a trademark of Texas Instruments.  
All other trademarks are the property of their respective owners.

### 11.3 Electrostatic Discharge Caution



These devices have limited built-in ESD protection. The leads should be shorted together or the device placed in conductive foam during storage or handling to prevent electrostatic damage to the MOS gates.

### 11.4 Glossary

[SLYZ022](#) — *TI Glossary*.

This glossary lists and explains terms, acronyms, and definitions.

## 12 Mechanical, Packaging, and Orderable Information

The following pages include mechanical, packaging, and orderable information. This information is the most current data available for the designated devices. This data is subject to change without notice and revision of this document. For browser-based versions of this data sheet, refer to the left-hand navigation.

**PACKAGING INFORMATION**

| Orderable Device | Status<br>(1) | Package Type | Package Drawing | Pins | Package Qty | Eco Plan<br>(2) | Lead finish/<br>Ball material<br>(6) | MSL Peak Temp<br>(3) | Op Temp (°C) | Device Marking<br>(4/5) | Samples                 |
|------------------|---------------|--------------|-----------------|------|-------------|-----------------|--------------------------------------|----------------------|--------------|-------------------------|-------------------------|
| TPS7A3701DRVR    | ACTIVE        | WSON         | DRV             | 6    | 3000        | RoHS & Green    | NIPDAU                               | Level-2-260C-1 YEAR  | -40 to 125   | SJI                     | <a href="#">Samples</a> |
| TPS7A3701DRVT    | ACTIVE        | WSON         | DRV             | 6    | 250         | RoHS & Green    | NIPDAU                               | Level-2-260C-1 YEAR  | -40 to 125   | SJI                     | <a href="#">Samples</a> |
| TPS7A3721DRVR    | ACTIVE        | WSON         | DRV             | 6    | 3000        | RoHS & Green    | NIPDAU                               | Level-2-260C-1 YEAR  | -40 to 125   | SIX                     | <a href="#">Samples</a> |
| TPS7A3721DRVT    | ACTIVE        | WSON         | DRV             | 6    | 250         | RoHS & Green    | NIPDAU                               | Level-2-260C-1 YEAR  | -40 to 125   | SIX                     | <a href="#">Samples</a> |
| TPS7A3725DRVR    | ACTIVE        | WSON         | DRV             | 6    | 3000        | RoHS & Green    | NIPDAU                               | Level-2-260C-1 YEAR  | -40 to 125   | SJH                     | <a href="#">Samples</a> |
| TPS7A3725DRVT    | OBSOLETE      | WSON         | DRV             | 6    |             | TBD             | Call TI                              | Call TI              | -40 to 125   | SJH                     |                         |

(1) The marketing status values are defined as follows:

**ACTIVE:** Product device recommended for new designs.

**LIFEBUY:** TI has announced that the device will be discontinued, and a lifetime-buy period is in effect.

**NRND:** Not recommended for new designs. Device is in production to support existing customers, but TI does not recommend using this part in a new design.

**PREVIEW:** Device has been announced but is not in production. Samples may or may not be available.

**OBSOLETE:** TI has discontinued the production of the device.

(2) **RoHS:** TI defines "RoHS" to mean semiconductor products that are compliant with the current EU RoHS requirements for all 10 RoHS substances, including the requirement that RoHS substance do not exceed 0.1% by weight in homogeneous materials. Where designed to be soldered at high temperatures, "RoHS" products are suitable for use in specified lead-free processes. TI may reference these types of products as "Pb-Free".

**RoHS Exempt:** TI defines "RoHS Exempt" to mean products that contain lead but are compliant with EU RoHS pursuant to a specific EU RoHS exemption.

**Green:** TI defines "Green" to mean the content of Chlorine (Cl) and Bromine (Br) based flame retardants meet JS709B low halogen requirements of <=1000ppm threshold. Antimony trioxide based flame retardants must also meet the <=1000ppm threshold requirement.

(3) MSL, Peak Temp. - The Moisture Sensitivity Level rating according to the JEDEC industry standard classifications, and peak solder temperature.

(4) There may be additional marking, which relates to the logo, the lot trace code information, or the environmental category on the device.

(5) Multiple Device Markings will be inside parentheses. Only one Device Marking contained in parentheses and separated by a "~" will appear on a device. If a line is indented then it is a continuation of the previous line and the two combined represent the entire Device Marking for that device.

(6) Lead finish/Ball material - Orderable Devices may have multiple material finish options. Finish options are separated by a vertical ruled line. Lead finish/Ball material values may wrap to two lines if the finish value exceeds the maximum column width.



**Important Information and Disclaimer:**The information provided on this page represents TI's knowledge and belief as of the date that it is provided. TI bases its knowledge and belief on information provided by third parties, and makes no representation or warranty as to the accuracy of such information. Efforts are underway to better integrate information from third parties. TI has taken and continues to take reasonable steps to provide representative and accurate information but may not have conducted destructive testing or chemical analysis on incoming materials and chemicals. TI and TI suppliers consider certain information to be proprietary, and thus CAS numbers and other limited information may not be available for release.

In no event shall TI's liability arising out of such information exceed the total purchase price of the TI part(s) at issue in this document sold by TI to Customer on an annual basis.

**TAPE AND REEL INFORMATION**

**QUADRANT ASSIGNMENTS FOR PIN 1 ORIENTATION IN TAPE**

\*All dimensions are nominal

| Device        | Package Type | Package Drawing | Pins | SPQ  | Reel Diameter (mm) | Reel Width W1 (mm) | A0 (mm) | B0 (mm) | K0 (mm) | P1 (mm) | W (mm) | Pin1 Quadrant |
|---------------|--------------|-----------------|------|------|--------------------|--------------------|---------|---------|---------|---------|--------|---------------|
| TPS7A3721DRVR | WSON         | DRV             | 6    | 3000 | 179.0              | 8.4                | 2.2     | 2.2     | 1.2     | 4.0     | 8.0    | Q2            |
| TPS7A3721DRVT | WSON         | DRV             | 6    | 250  | 179.0              | 8.4                | 2.2     | 2.2     | 1.2     | 4.0     | 8.0    | Q2            |
| TPS7A3725DRVR | WSON         | DRV             | 6    | 3000 | 179.0              | 8.4                | 2.2     | 2.2     | 1.2     | 4.0     | 8.0    | Q2            |

**TAPE AND REEL BOX DIMENSIONS**

\*All dimensions are nominal

| Device        | Package Type | Package Drawing | Pins | SPQ  | Length (mm) | Width (mm) | Height (mm) |
|---------------|--------------|-----------------|------|------|-------------|------------|-------------|
| TPS7A3721DRVR | WSON         | DRV             | 6    | 3000 | 213.0       | 191.0      | 35.0        |
| TPS7A3721DRV  | WSON         | DRV             | 6    | 250  | 213.0       | 191.0      | 35.0        |
| TPS7A3725DRVR | WSON         | DRV             | 6    | 3000 | 213.0       | 191.0      | 35.0        |

## GENERIC PACKAGE VIEW

DRV 6

WSON - 0.8 mm max height

PLASTIC SMALL OUTLINE - NO LEAD



Images above are just a representation of the package family, actual package may vary.  
Refer to the product data sheet for package details.

4206925/F

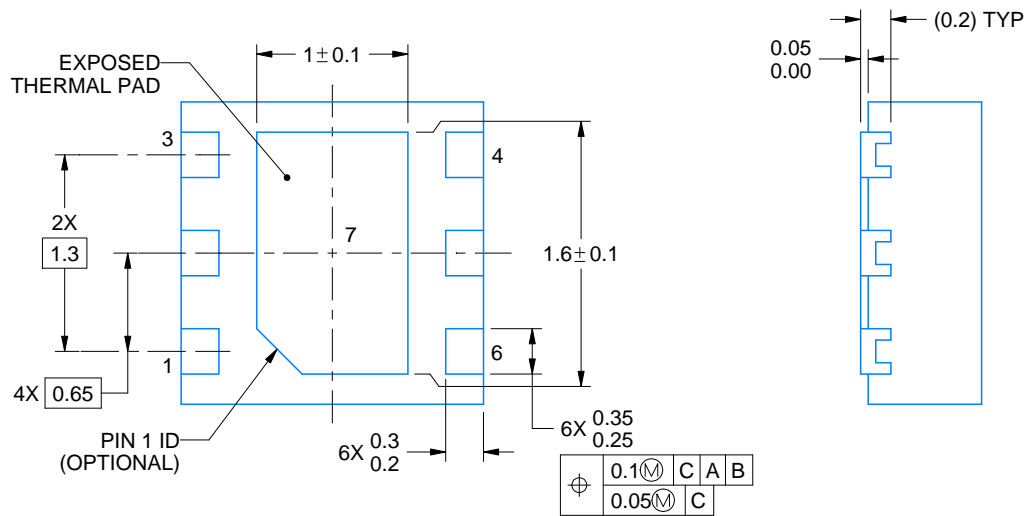
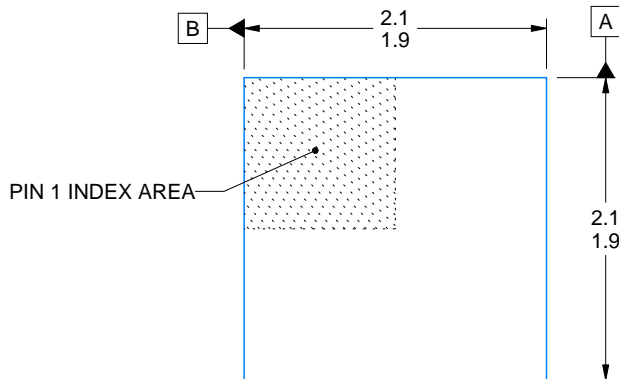

4225563/A 12/2019

NOTES:

1. All linear dimensions are in millimeters. Any dimensions in parenthesis are for reference only. Dimensioning and tolerancing per ASME Y14.5M.
2. This drawing is subject to change without notice.
3. The package thermal pad must be soldered to the printed circuit board for thermal and mechanical performance.

# EXAMPLE BOARD LAYOUT

DRV0006D

WSON - 0.8 mm max height

PLASTIC SMALL OUTLINE - NO LEAD



LAND PATTERN EXAMPLE  
EXPOSED METAL SHOWN  
SCALE:25X

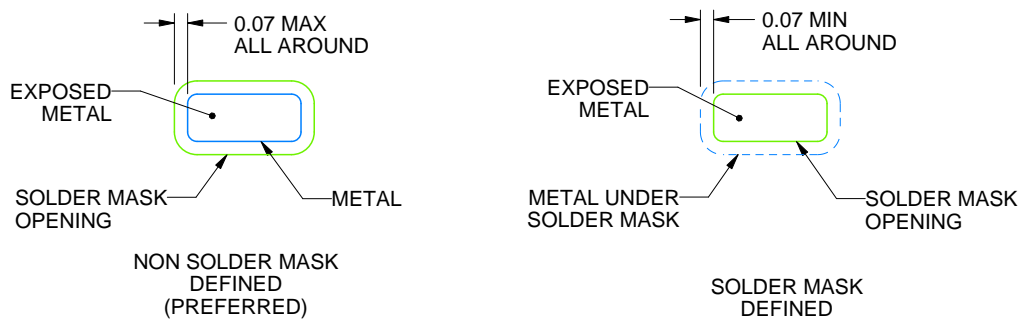

SOLDER MASK DETAILS

4225563/A 12/2019

NOTES: (continued)

- This package is designed to be soldered to a thermal pad on the board. For more information, see Texas Instruments literature number SLUA271 ([www.ti.com/lit/sluea271](http://www.ti.com/lit/sluea271)).
- Vias are optional depending on application, refer to device data sheet. If some or all are implemented, recommended via locations are shown.

# EXAMPLE STENCIL DESIGN

DRV0006D

WSON - 0.8 mm max height

PLASTIC SMALL OUTLINE - NO LEAD



SOLDER PASTE EXAMPLE  
BASED ON 0.125 mm THICK STENCIL

EXPOSED PAD #7  
88% PRINTED SOLDER COVERAGE BY AREA UNDER PACKAGE  
SCALE:30X

4225563/A 12/2019

NOTES: (continued)

6. Laser cutting apertures with trapezoidal walls and rounded corners may offer better paste release. IPC-7525 may have alternate design recommendations.

## IMPORTANT NOTICE AND DISCLAIMER

TI PROVIDES TECHNICAL AND RELIABILITY DATA (INCLUDING DATA SHEETS), DESIGN RESOURCES (INCLUDING REFERENCE DESIGNS), APPLICATION OR OTHER DESIGN ADVICE, WEB TOOLS, SAFETY INFORMATION, AND OTHER RESOURCES "AS IS" AND WITH ALL FAULTS, AND DISCLAIMS ALL WARRANTIES, EXPRESS AND IMPLIED, INCLUDING WITHOUT LIMITATION ANY IMPLIED WARRANTIES OF MERCHANTABILITY, FITNESS FOR A PARTICULAR PURPOSE OR NON-INFRINGEMENT OF THIRD PARTY INTELLECTUAL PROPERTY RIGHTS.

These resources are intended for skilled developers designing with TI products. You are solely responsible for (1) selecting the appropriate TI products for your application, (2) designing, validating and testing your application, and (3) ensuring your application meets applicable standards, and any other safety, security, regulatory or other requirements.

These resources are subject to change without notice. TI grants you permission to use these resources only for development of an application that uses the TI products described in the resource. Other reproduction and display of these resources is prohibited. No license is granted to any other TI intellectual property right or to any third party intellectual property right. TI disclaims responsibility for, and you will fully indemnify TI and its representatives against, any claims, damages, costs, losses, and liabilities arising out of your use of these resources.

TI's products are provided subject to [TI's Terms of Sale](#) or other applicable terms available either on [ti.com](https://www.ti.com) or provided in conjunction with such TI products. TI's provision of these resources does not expand or otherwise alter TI's applicable warranties or warranty disclaimers for TI products.

TI objects to and rejects any additional or different terms you may have proposed.

Mailing Address: Texas Instruments, Post Office Box 655303, Dallas, Texas 75265

Copyright © 2025, Texas Instruments Incorporated