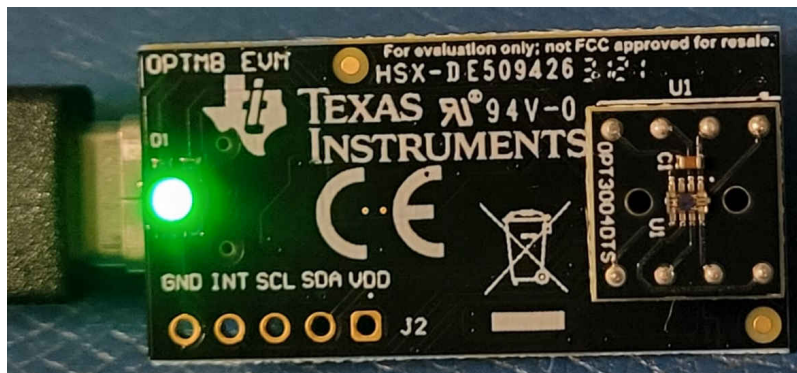




## ABSTRACT

This user's guide describes the characteristics, operation, and use of the OPT3004DTSEVM evaluation module. It discusses how to set up and configure the software and hardware, and reviews various aspects of the program operation. Throughout this document, the terms evaluation board, evaluation module, and EVM are synonymous with the OPT3004DTSEVM. This document also includes an electrical schematic, printed circuit board (PCB) layout drawings, and a parts list for the EVM.



## Table of Contents

<b>1 Overview</b> .....	<b>3</b>
1.1 OPT3004DTSEVM Kit Contents.....	3
1.2 Related Documentation from Texas Instruments.....	4
<b>2 OPT3004DTSEVM Hardware</b> .....	<b>5</b>
2.1 Theory of Operation for the OPT3004DTSEVM.....	6
2.2 OPT3004DTSEVM Hardware Overview.....	6
<b>3 OPT3004DTSEVM Software</b> .....	<b>7</b>
3.1 Hardware Requirements.....	7
3.2 Software Installation.....	7
3.3 Typical OPT3004DTSEVM Hardware Setup.....	11
3.4 Launching the OPT3004EVM Software.....	13
3.5 OPT3004DTSEVM Software Operation.....	14
<b>4 Schematic, PCB Layout, and Bill of Materials</b> .....	<b>19</b>
4.1 Coupon Board.....	19
4.2 Motherboard.....	22
<b>5 Troubleshooting</b> .....	<b>27</b>
5.1 Microsoft Windows 7 Manual Driver Installation.....	27
<b>6 Revision History</b> .....	<b>33</b>

## List of Figures

Figure 1-1. Hardware Included with OPT3004DTSEVM Kit.....	3
Figure 2-1. OPT3004DTSEVM Hardware Setup.....	5
Figure 3-1. OPT3004DTSEVM Software-Installation File.....	7
Figure 3-2. OPT3004DTSEVM Software-Installation Launch.....	8
Figure 3-3. OPT3004DTSEVM Software-Installation Prompts.....	8
Figure 3-4. OPT3004DTSEVM Software-Installation Prompts.....	9
Figure 3-5. OPT3004DTSEVM Software-Installation Prompts.....	9
Figure 3-6. OPT3004DTSEVM Software-Installation Prompts.....	10

Figure 3-7. OPT3004DTSEVM Software-Installation Prompts.....	10
Figure 3-8. OPT3004DTSEVM Software-Installation Prompts.....	11
Figure 3-9. Typical Hardware Connection.....	11
Figure 3-10. Typical Response After Connecting OPT3004DTSEVM to the Computer.....	12
Figure 3-11. OPT3004 Main Operation Screen.....	13
Figure 3-12. Hardware Error Message.....	13
Figure 3-13. GUI Capture Running.....	14
Figure 3-14. Latte Scripts Window.....	16
Figure 3-15. Registers View.....	17
Figure 4-1. OPT3004 Coupon Board Schematic.....	19
Figure 4-2. PCB Top Layer.....	20
Figure 4-3. PCB Bottom Layer.....	20
Figure 4-4. PCB Top-Layer Assembly Drawing.....	21
Figure 4-5. PCB Bottom-Layer Assembly Drawing.....	21
Figure 4-6. OPTMBEVM Schematic.....	22
Figure 4-7. PCB Top Layer.....	23
Figure 4-8. PCB Bottom Layer.....	23
Figure 4-9. PCB Top-Layer Assembly Drawing.....	24
Figure 4-10. PCB Bottom-Layer Assembly Drawing.....	24
Figure 5-1. OPT3004DTSEVM on Microsoft® Windows® 7 With Drivers not Installed.....	27

## Trademarks

Windows 10®, Microsoft®, and Windows® are registered trademarks of Microsoft Corporation.  
 All trademarks are the property of their respective owners.

## 1 Overview

The [OPT3004](#) is an ambient light sensor (ALS) with a digital output integrated circuit. It uses a two-wire interface that works with the I<sup>2</sup>C protocol making it ideal for many applications. The OPT3004DTSEVM is a platform for evaluating the performance of the OPT3004 under various conditions. The OPT3004DTSEVM consists of two PCBs. The first is the OPTMB EVM board that communicates with the computer, provides power, and sends and receives appropriate digital signals. The second is the OPT3004DTS coupon board, which contains the OPT3004DTS and its support circuitry.

### 1.1 OPT3004DTSEVM Kit Contents

[Table 1-1](#) summarizes the contents of the OPT3004DTSEVM kit. [Figure 1-1](#) shows the included hardware. Contact the [Texas Instruments Product Information Center](#) nearest you if any component is missing. It is highly recommended that you also check the [OPT3004 Product Folder](#) on the TI web site at [www.ti.com](http://www.ti.com) to verify you have the latest versions of the released software.

**Table 1-1. OPT3004DTSEVM Kit Contents**

Item	Quantity
OPT3004 coupon board (Installed on OPTMBEVM)	1
OPTMBEVM board	1
USB type A to type C cable	1



**Figure 1-1. Hardware Included with OPT3004DTSEVM Kit**

## 1.2 Related Documentation from Texas Instruments

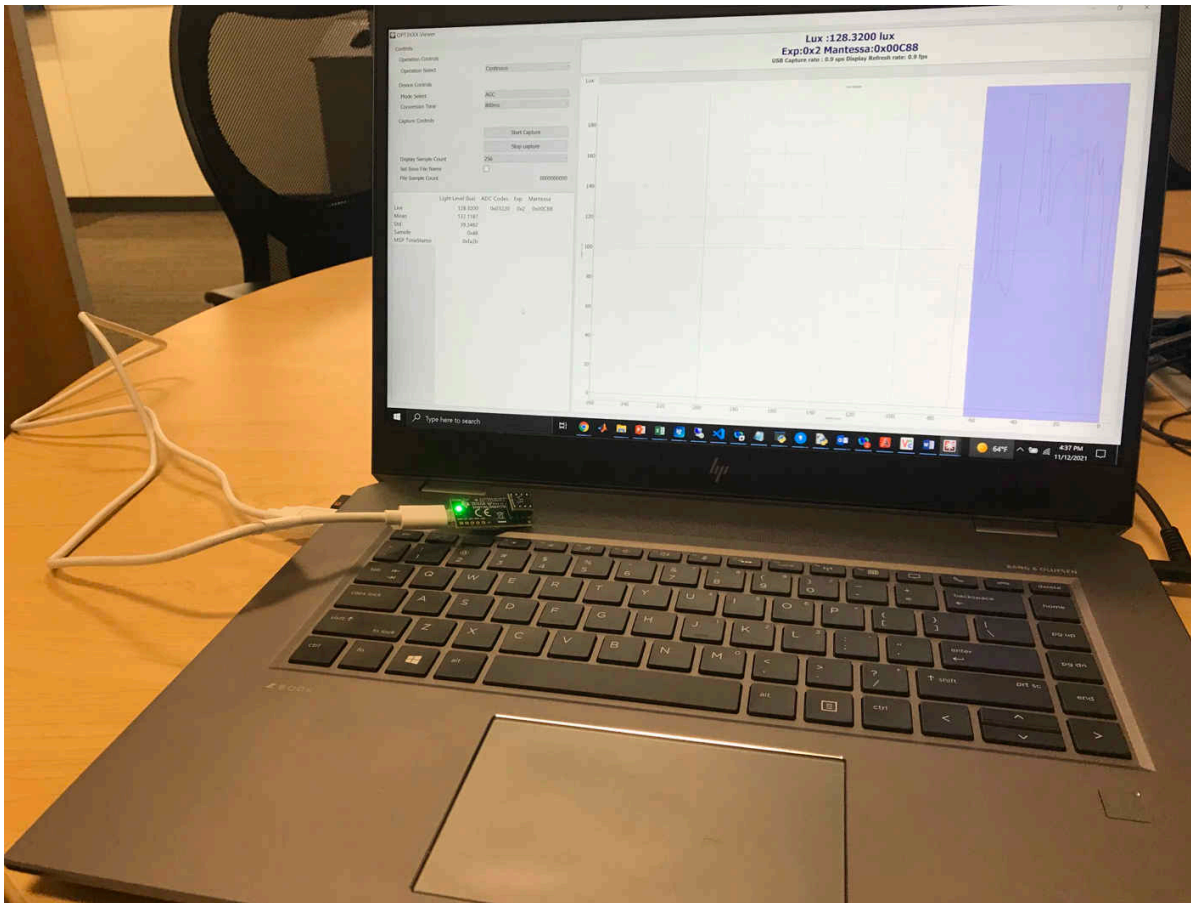
The following documents provide information regarding Texas Instruments' integrated circuits used in the assembly of the OPT3004DTSEVM. This user's guide is available from the TI web site under literature number **SBOU274**. Any letter appended to the literature number corresponds to the document revision that is current at the time of the writing of this document. The latest revision can be found by clicking the link [Table 1-2](#) and is also available from the [TI web site](#), the Texas Instruments' Literature Response Center at (800) 477-8924, and the Product Information Center at (972) 644-5580. When ordering, identify the document by both title and literature number.

**Table 1-2. Related Documentation**

Document	Literature Number
OPT3004 product data sheet	<a href="#">SBOS929</a>

## 2 OPT3004DTSEVM Hardware

Figure 2-1 shows the system setup for the OPT3004DTSEVM. The computer runs the graphical user interface (GUI) software that communicates with the OPTMBEVM board over a USB connection. The OPTMBEVM has a USB Type C port and ships with a USB-C to USB-A cable. The OPTMBEVM board acts as a bridge between the software running on the PC and the OPT3004DTS coupon board. The MSP430 on the OPTMBEVM receives USB commands from the PC and communicates with the OPT3004DTS over I2C.



**Figure 2-1. OPT3004DTSEVM Hardware Setup**

## 2.1 Theory of Operation for the OPT3004DTSEVM

The OPT3004 coupon consists of the OPT3004 IC, decoupling capacitor, and 8 pins. The pins create connections for the power, I<sup>2</sup>C, and an interrupt signal between the coupon and the EVM motherboard. For evaluation purposes the coupon can be removed from the motherboard to use with other platforms. The motherboard also has an unpopulated 5-pin header footprint for easy access to the supply, ground, I2C and interrupt lines.

## 2.2 OPT3004DTSEVM Hardware Overview

The EVM ships with the coupon plugged into the motherboard. If not already assembled, the basic hardware setup for the OPT3004DTSEVM involves plugging the coupon board into the motherboard socket. Take special care to make sure the coupon is oriented correctly as shown in [Figure 1-1](#). Then connect the USB cable. This section presents the details of this procedure.

### CAUTION

Many of the components on the OPT3004DTSEVM are susceptible to damage by electrostatic discharge (ESD). Customers are advised to observe proper ESD handling precautions when unpacking and handling the EVM, including the use of a grounded wrist strap at an approved ESD workstation.

### 3 OPT3004DTSEVM Software

This section describes the installation and operation of the OPT3004DTSEVM software. The OPT3004DTSEVM uses the TI Latte software, which is available for download on the EVM page.

#### 3.1 Hardware Requirements

The OPT3001EVM software has been tested on the Windows 10® operating system (OS) with United States regional settings. The software should function correctly on other Windows operating systems.

#### 3.2 Software Installation

The OPT3004DTSEVM software is available through the [OPT3004DTSEVM Product Folder](#) on the TI web site (www.ti.com). To install the software to your computer, navigate to the OPT3004DTSEVM software, and open the installer directory. Launch the OPT3004DTSEVM installation file, *OPT3004DTS\_EVM\_Latte.exe*, as shown in the figure below.

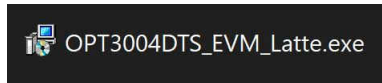
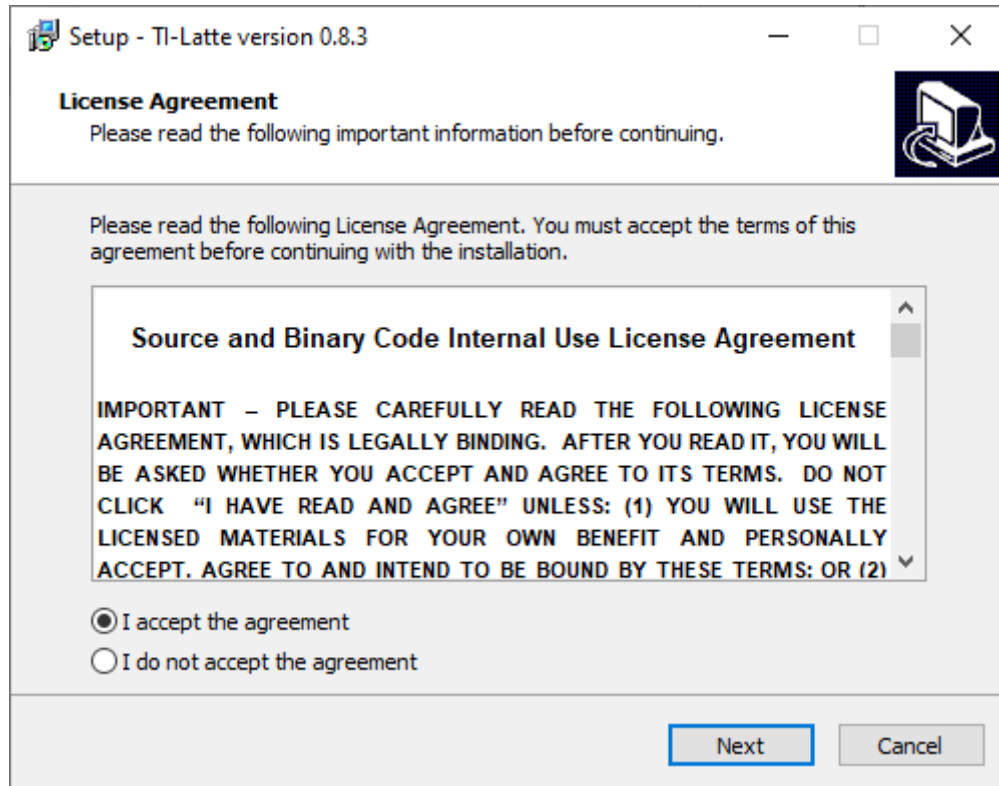


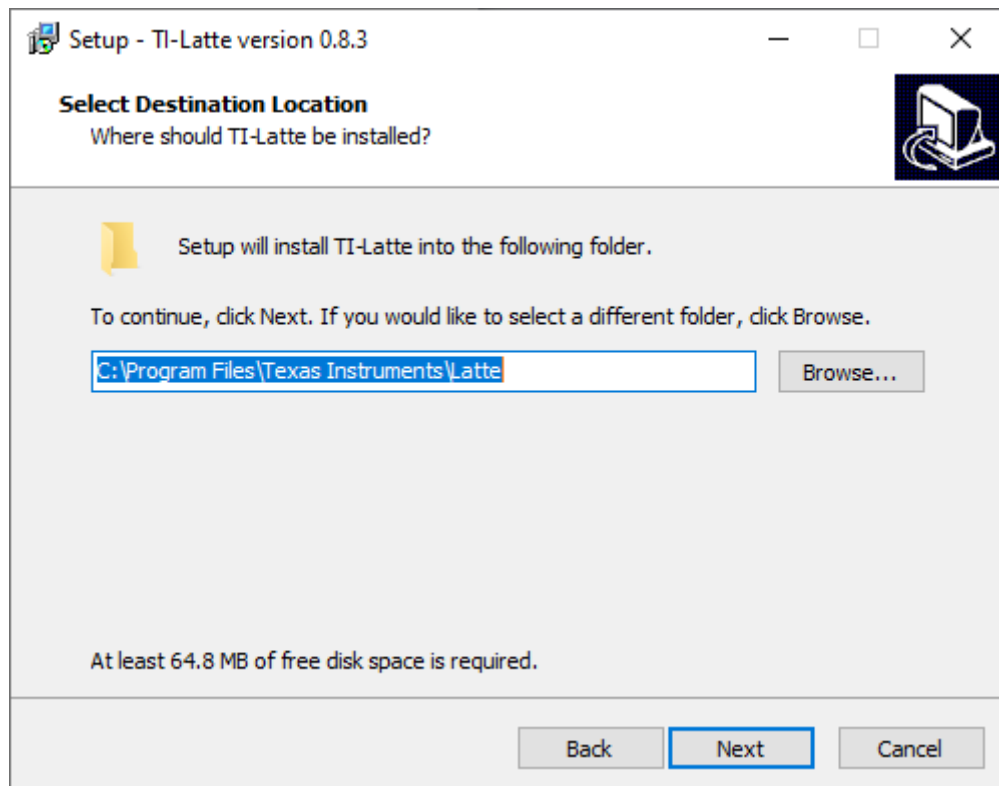
Figure 3-1. OPT3004DTSEVM Software-Installation File

The OPT3004EVM software then begins the installation process, as shown in [Figure 3-2](#).



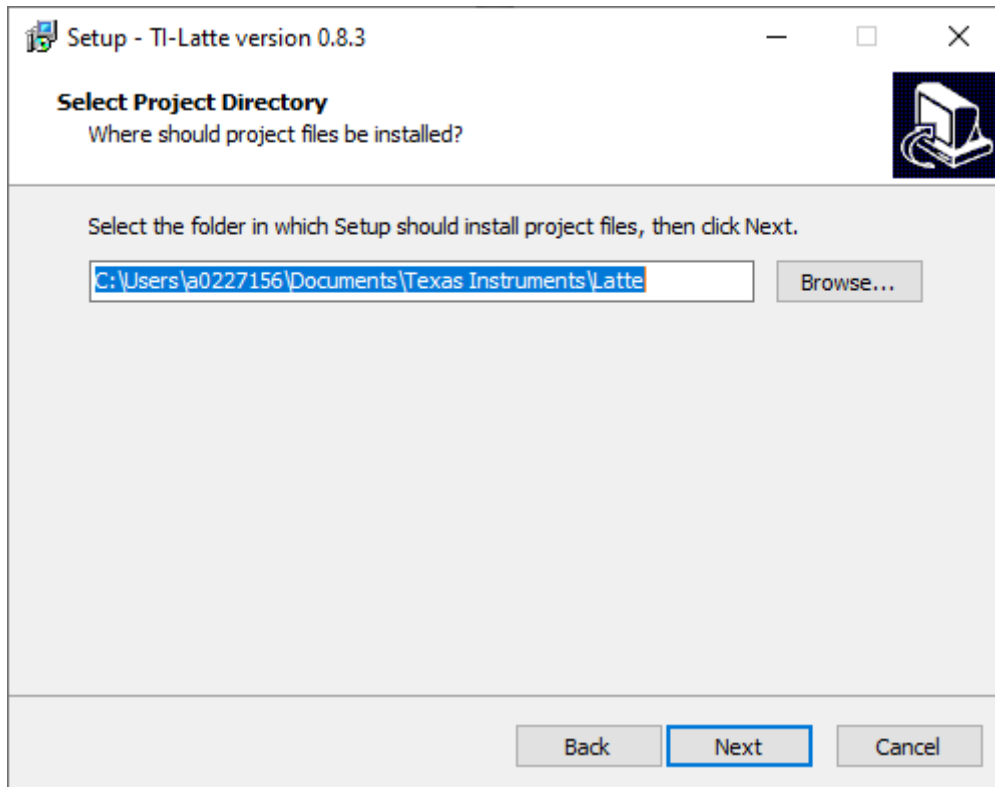
**Figure 3-2. OPT3004DTSEVM Software-Installation Launch**

Follow the prompts as shown in [Figure 3-3](#) to [Figure 3-8](#) to install the OPT3004DTSEVM software.

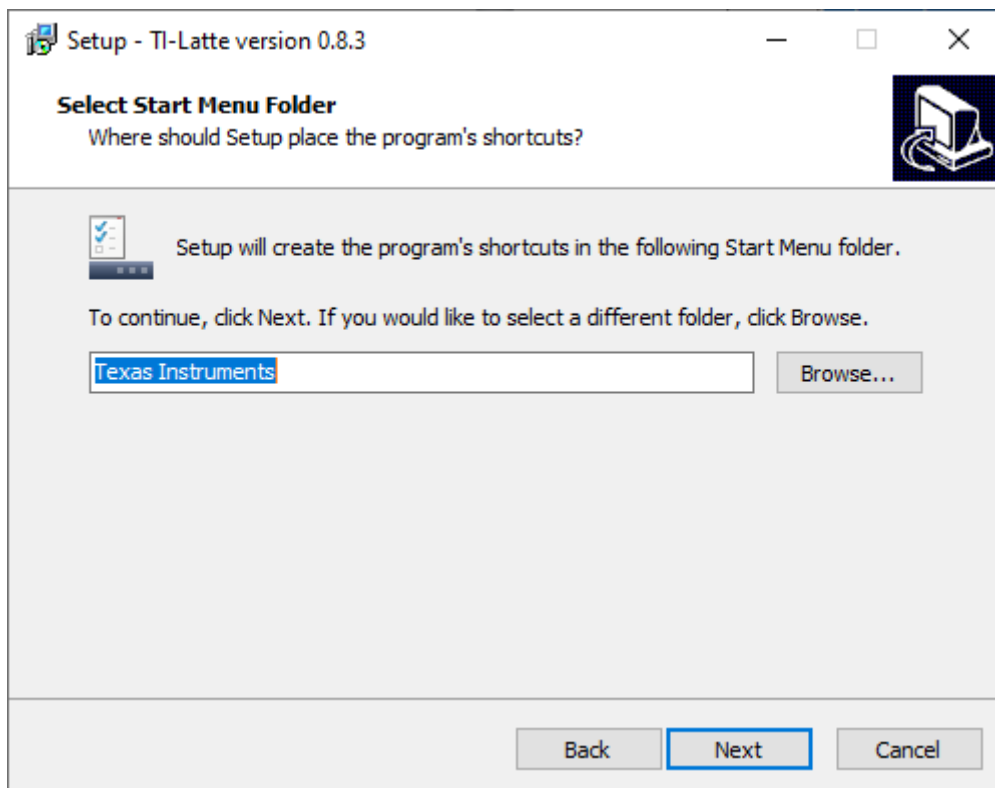


**Figure 3-3. OPT3004DTSEVM Software-Installation Prompts**

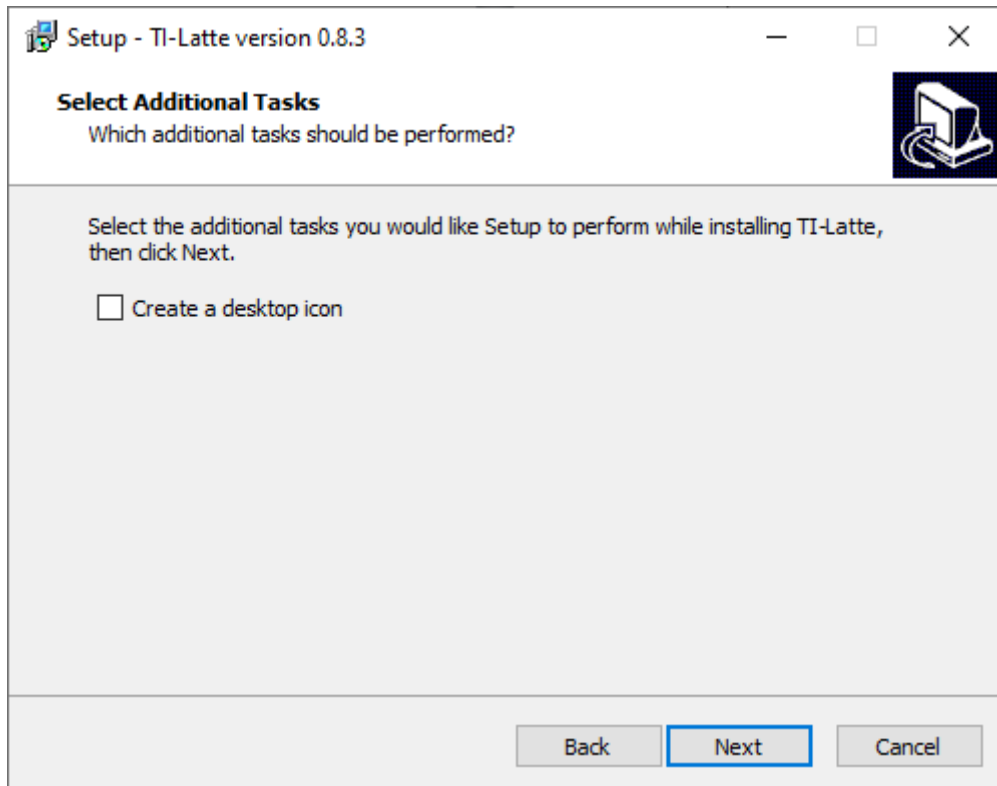




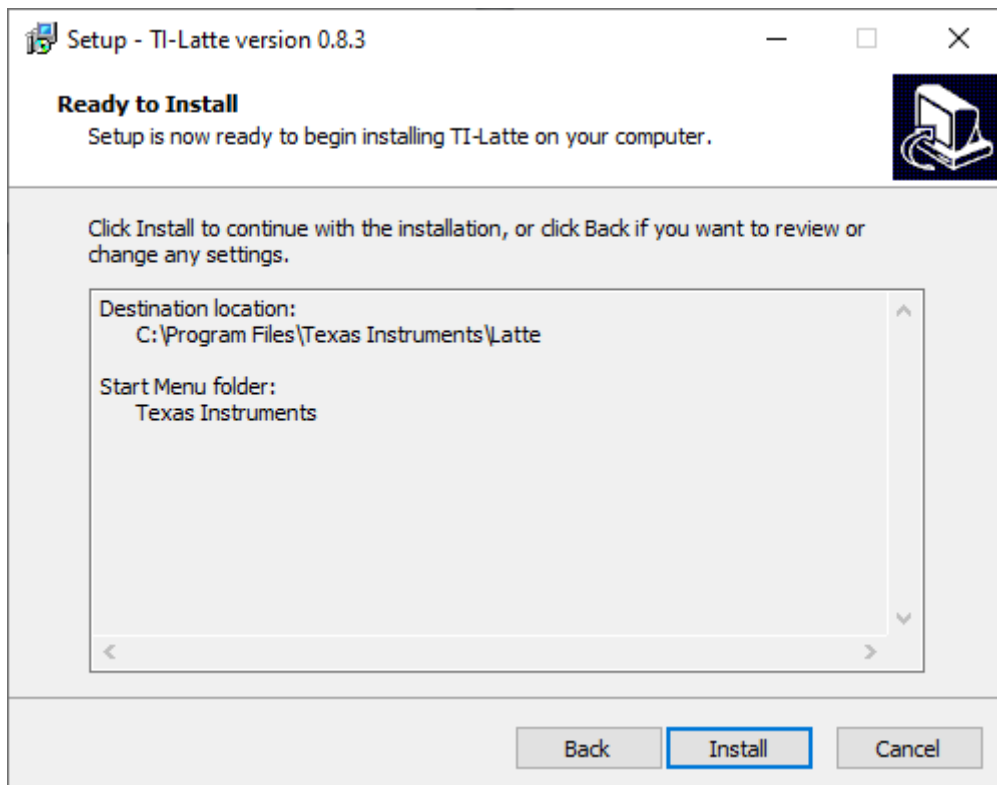
**Figure 3-4. OPT3004DTSEVM Software-Installation Prompts**



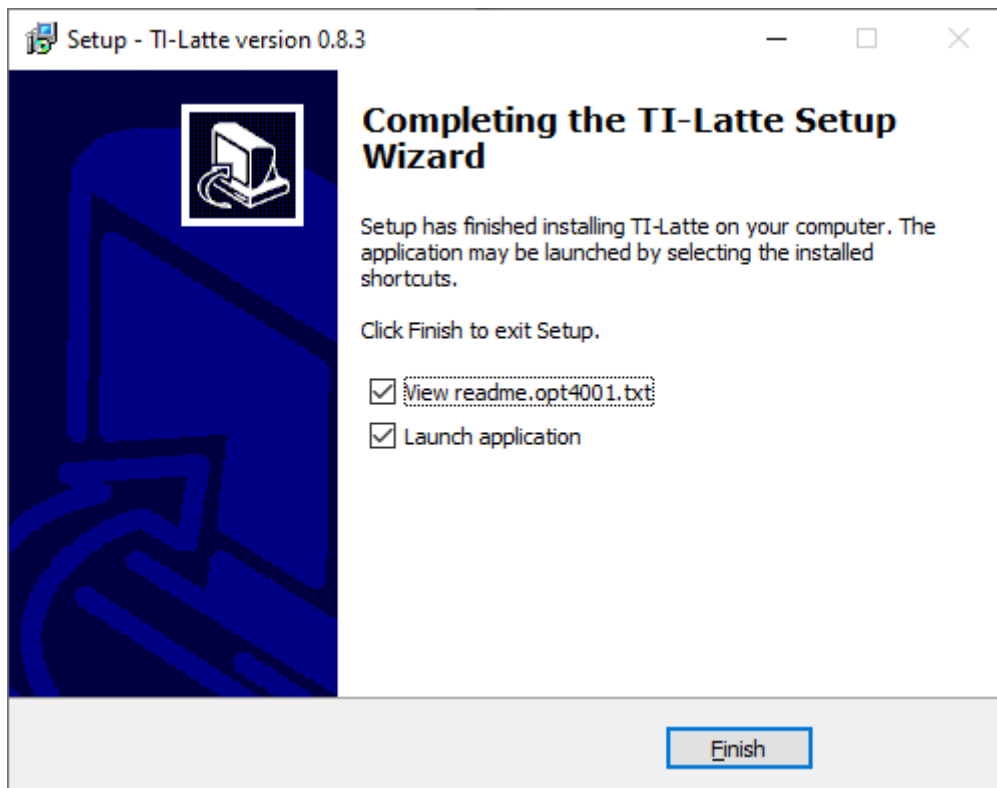
**Figure 3-5. OPT3004DTSEVM Software-Installation Prompts**



**Figure 3-6. OPT3004DTSEVM Software-Installation Prompts**



**Figure 3-7. OPT3004DTSEVM Software-Installation Prompts**

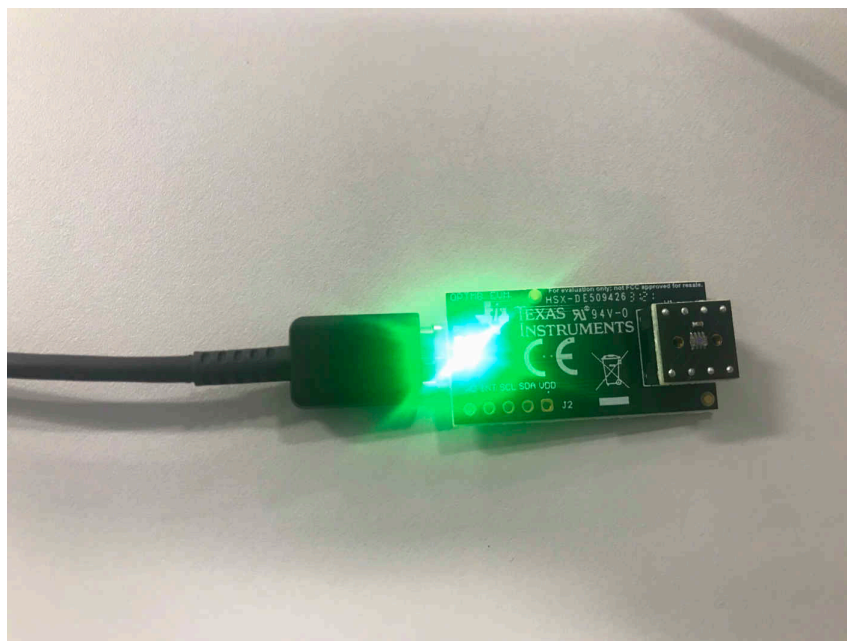


**Figure 3-8. OPT3004DTSEVM Software-Installation Prompts**

The OPT3004EVM GUI software is now installed.

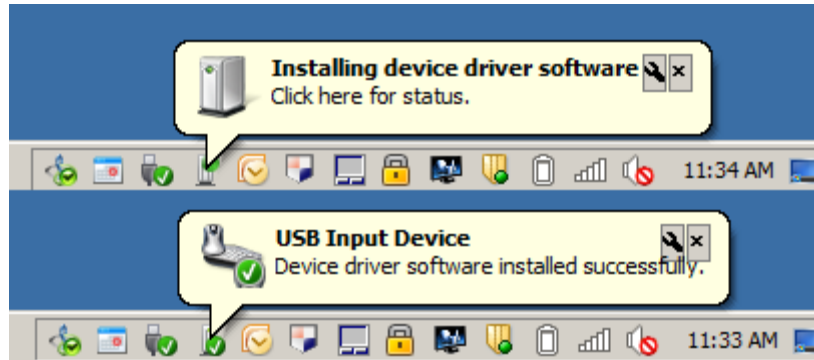
### 3.3 Typical OPT3004DTSEVM Hardware Setup

Plug the male USB-C cable to the OPTMBEVM board and then plug the male USB-A cable into the computer. The green light will light up on the EVM as shown in the figure below.



**Figure 3-9. Typical Hardware Connection**

The figure below shows the typical response when the EVM is plugged into the USB port of the computer for the first time. Typically, the computer responds with a *Found New Hardware, USB Device* pop-up dialog window. The pop-up window then typically changes to *Found New Hardware, USB Human Interface Device*. This pop-up indicates that the device is ready to be used.

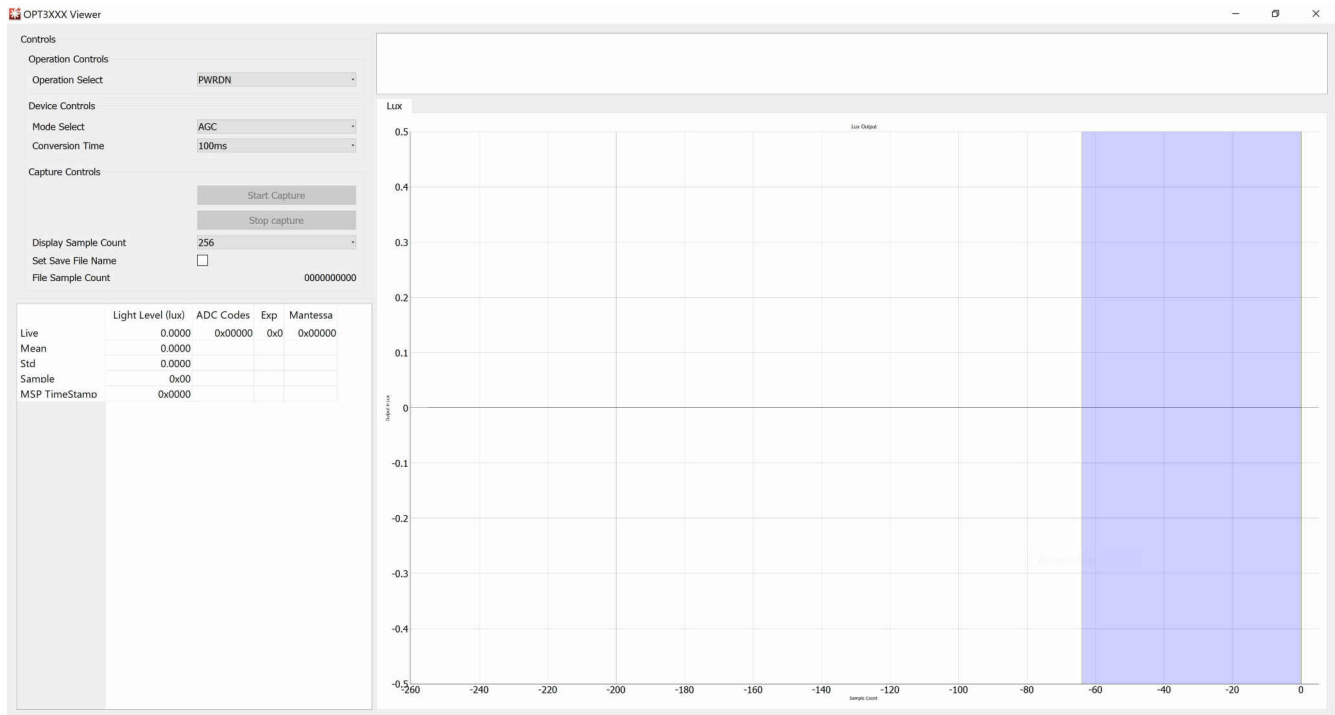


**Figure 3-10. Typical Response After Connecting OPT3004DTSEVM to the Computer**

Connect the EVM via USB to the PC. If Windows shows a notification that a driver is not found for the device connected, see the instructions to manually install drivers in [Section 5.1](#) before proceeding.

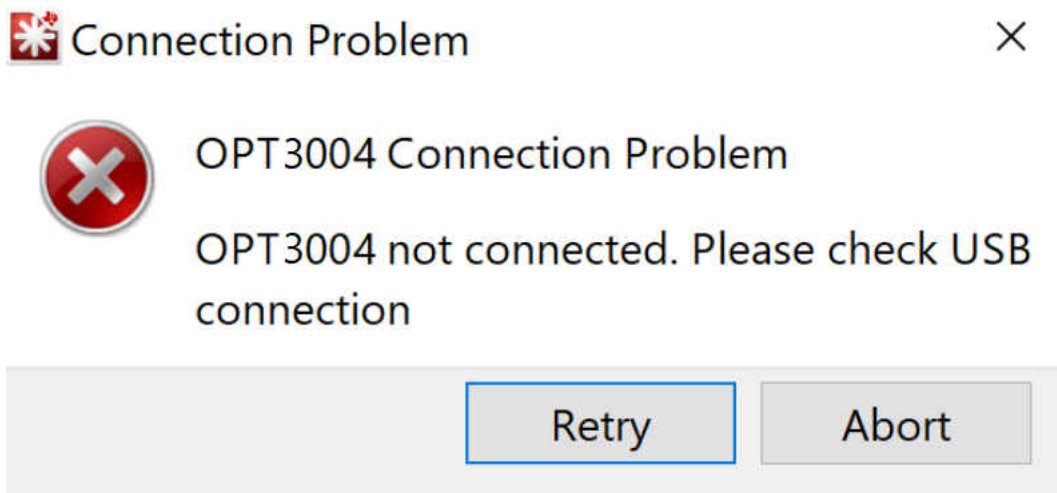
### 3.4 Launching the OPT3004EVM Software

With the OPT3004DTSEVM properly connected, launch the Latte EVM GUI software from the Windows *Start* menu. The software launches with a screen similar to that shown in [Figure 3-11](#).



**Figure 3-11. OPT3004 Main Operation Screen**

If the message shown in [Figure 3-12](#) appears when the OPT3004EVM GUI software is launched, this means that the EVM motherboard was not detected. Check the USB connection and that the motherboard appears in the device manager as shown. A green light will appear on the motherboard if it is receiving power from the PC and the GUI "start capture" button has not been clicked.



**Figure 3-12. Hardware Error Message**

## 3.5 OPT3004DTSEVM Software Operation

This section primarily discusses how to operate the OPT3004DTSEVM software. The GUI has a primary window that is used to configure and read from the OPT3004DTSEVM, along with two other windows that are used to access different features of the OPT3004DTSEVM. Basic GUI functionality and a description of the tabs are also presented in this section.

### 3.5.1 Getting Started

To quickly start using the device, click the "Operation Select" dropdown and select "Continuous" to bring the device out of power down mode. Then click "Start Capture" to begin data capture. The green LED on the motherboard will turn off. Lux data will appear above the lux plot as shown. The plot will also start to populate with the device lux readings.



**Figure 3-13. GUI Capture Running**

If the GUI is not responsive, check the other Latte scripts window, which is minimized by default. If the message "Operation I2C Register Read for command [REGRx01] Failed." is displayed this means that the OPT3004 IC or coupon is not detected by the motherboard. Ensure the coupon is plugged in and properly oriented.

### 3.5.2 Feature Descriptions

#### 3.5.2.1 Lux Plot

In the center of the GUI window you will see a plot showing the lux reading from the device on the y-axis and the sample number on the x-axis. The plot settings can be tweaked by right clicking on the plot. The x-axis and y-axis options under the right-click menu allow the range of x and y-axes displayed to be changed. There is also an auto option that will dynamically change the range to match the data. Scrolling will zoom in to or zoom out from the plot. Left-clicking and dragging will display a yellow rectangle that will, upon releasing the mouse, zoom the data to the rectangle drawn. Right-clicking and dragging up or down zooms the y-axis. Right-clicking and dragging right or left will zoom the x-axis. Right clicking and selecting "View All" will reset the view.

### 3.5.2.2 Drop-down Selectors

At the top left of the plot are two drop-down selectors.

The *operation select* drop-down menu allows the device operating mode to be switched between the power down and continuous capture modes. The oneshot mode of the device is not exposed by the EVM GUI.

The *mode select* drop down changes the device gain range setting mode. The device supports automatic gain control (ACG), which is the recommended mode setting for most use cases, or the gain range of the device can be selected manually using this drop-down menu.

The device supports two *conversion times*: 100 ms and 800 ms, which can be selected using the respective drop-down menu.

The *display sample count* selects how many samples are displayed on the x-axis of the plot.

### 3.5.2.3 Save to File

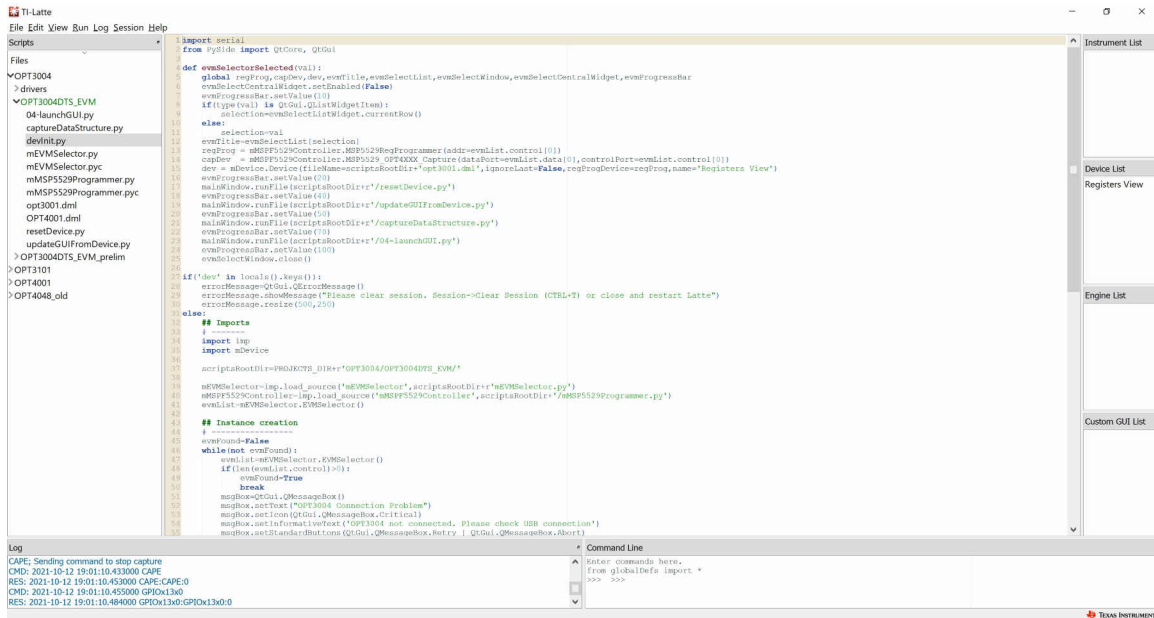
The *set save to file name* check box allows the data captured in the GUI to be dumped to a CSV file. Clicking this check box will display a windows file selector screen. Select the directory to store the CSV and set the name for the CSV. After clicking save the GUI will wait for you to click the *start capture* button to start saving data and subsequently it will wait for a click on the *stop capture* button to copy all the data into the indicated CSV file. When capturing data with save enabled, the GUI will initially dump the data to temporary .npy files. After clicking *stop capture* this data is written over to the CSV file and .npy files removed.

### 3.5.2.4 Mean, Std, and the Blue Slider

There is a blue slider on the lux plot shown on the right side of the plot in the figure. Mean and Std columns in the table where capture data is displayed are calculated from only the data within the blue slider. Left-clicking on the middle of this slider and dragging moves the slider. Left-clicking on the edge of either side of the slider and dragging will adjust the size of the slider. This allows the mean and standard deviation of the distance, phase, and amplitude to be computed for any continuous portion of the displayed data. If capture is running this data updates in real-time along with the data in the Live column.

### 3.5.2.5 Scripts Window

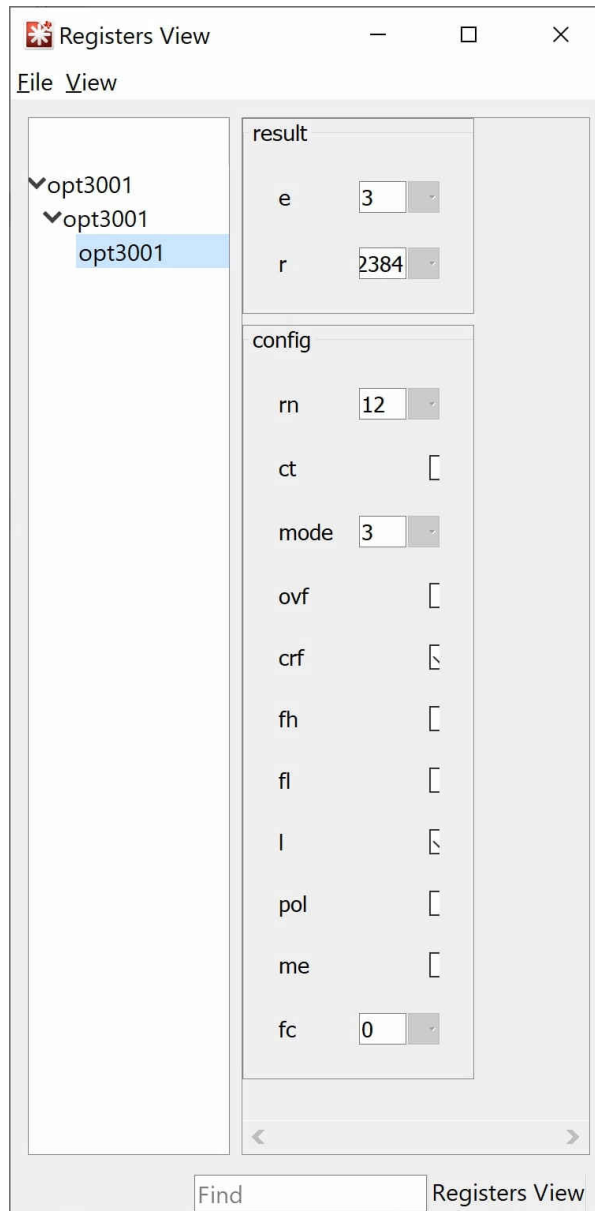
When Latte is launched the GUI window appears front and center. However, there is a second window that is minimized at launch. This is the scripts window and exposes some more advanced features of the Latte platform. See [Latte Scripts Window](#).



**Figure 3-14. Latte Scripts Window**

The scripts window also provides access to the device registers view that displays the stored value of the device registers and allows them to be changed directly. Launch the registers view by double clicking on the "Registers View" button under the "Device List" box on the right side of the screen.





**Figure 3-15. Registers View**

### 3.5.2.6 Overview of Device Registers

Register 0x00 is the result register and provides the output data from the device as an exponent and mantissa value indicated as e and r in the register view.

Register 0x01 is the configuration register and provides feedback about the state of the device; the bit names and full descriptions are shown in the [OPT3004 data sheet](#). Each of the read-only status bits are greyed out and cannot be changed.

Registers 0x02 and 0x03 enforce low and high limits, respectively, on the output ranges (exponent) and values (mantissa) from the OPT3004. These registers are not included in the register view.

### 3.5.2.7 Additional Features of the Scripts Window

#### 3.5.2.7.1 Hidden IDE Window

The Latte program runs a number of python scripts in the background to capture and display data from the EVM. These scripts allow for initialization of the device including loading calibration data from the EVM flash memory, launching a live view window with measurement plot and readings, and additional functionality such as reading from the flash and selecting a specific LED current for the device to use. For advance users or users looking for more flexibility when using the OPT3101EVM these python scripts are available in an integrated development environment (IDE) window that is minimized when TI-Latte is launched. The IDE window allows advanced users to customize the existing scripts or write new scripts.

After launching Latte, expand the OPT3004DTS directory on the left hand side of the window under Files by clicking the triangle to the left of the directory name. This displays the OPT3004DTSEVM folder. Further expanding the OPT3004DTSEVM folder will display all the example scripts as shown in the figure.

#### 3.5.2.7.2 devlNit.py

Open the devlNit.py script by clicking on the corresponding file in the OPT3004DTSEVM folder on the left side of the screen. This displays the contents of the script on the center of the window. With devlNit.py still selected in TI-Latte, click Run>Buffer from the top menu bar of TI-Latte (or press F5) to run the script. Once completed, the live view GUI is opened in a new window. More details on the live view GUI are given in the following section. Additional info is also displayed in the log window in the lower left- hand corner of the main window.

#### 3.5.2.7.3 04-launchGUI.py

A liveview GUI window is launched when running the devlNit.py script. This allows data from the OPT3004 to be viewed on a graph in real time. The GUI is created in the launchGUI.py example script. When running devlNit.py, the launchGUI.py script is automatically run. However, if the GUI window is closed it can be re-launched by directly running the launchGUI.py script. To do this, select the launchGUI.py script and click Run>Buffer or press F5. [Figure 3-13](#) shows the live GUI plot.

## 4 Schematic, PCB Layout, and Bill of Materials

### 4.1 Coupon Board

#### 4.1.1 Schematic

Figure 4-1 shows the schematic of the OPT3004DTS coupon board. C1 is a bypass capacitor for device VDD.

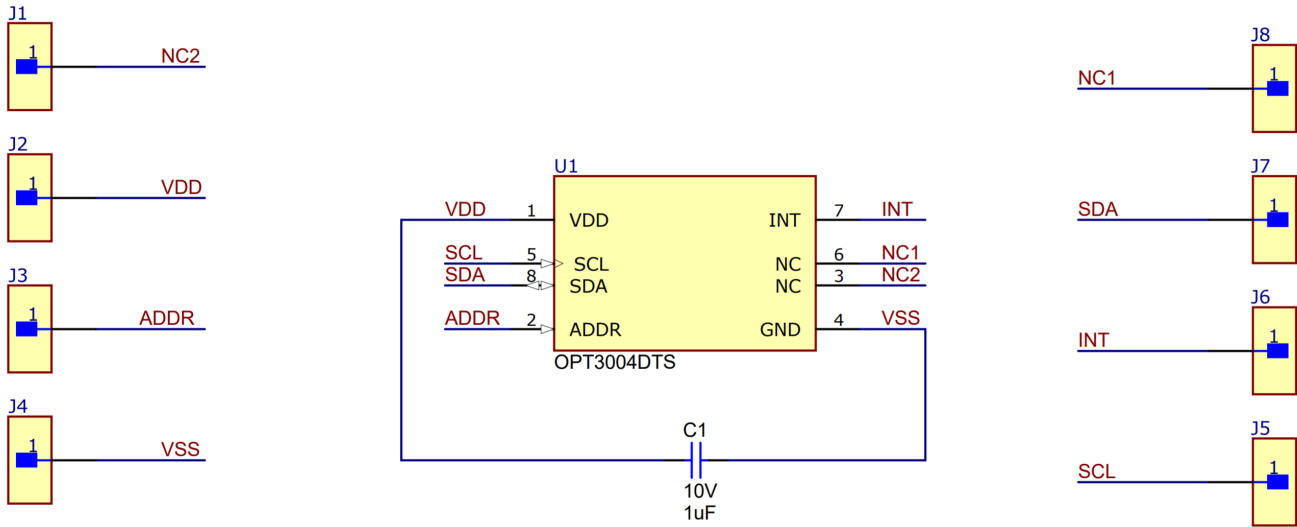


Figure 4-1. OPT3004 Coupon Board Schematic

### 4.1.2 PCB Layout

Figure 4-2 and Figure 4-3 show the top and bottom PCB layers, respectively, of the coupon board. Figure 4-4 and Figure 4-5 show the assembly drawings of the top and bottom PCB layers, respectively.

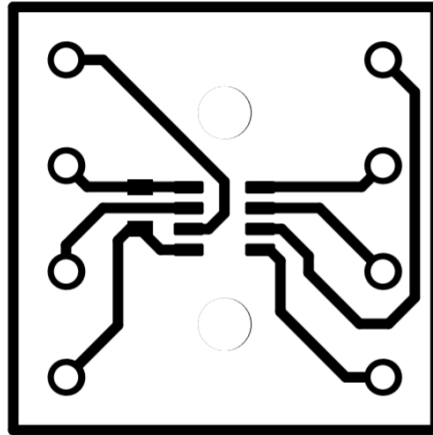


Figure 4-2. PCB Top Layer

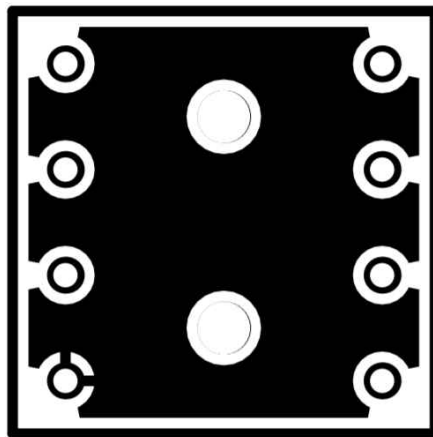


Figure 4-3. PCB Bottom Layer

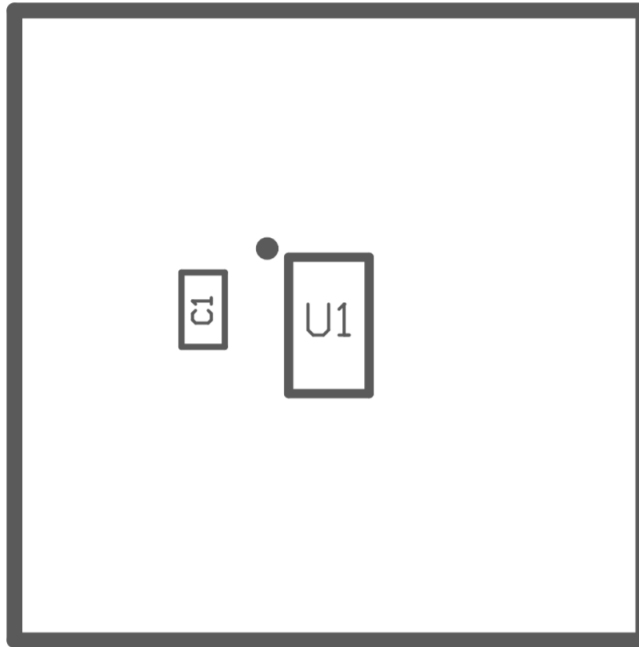


Figure 4-4. PCB Top-Layer Assembly Drawing

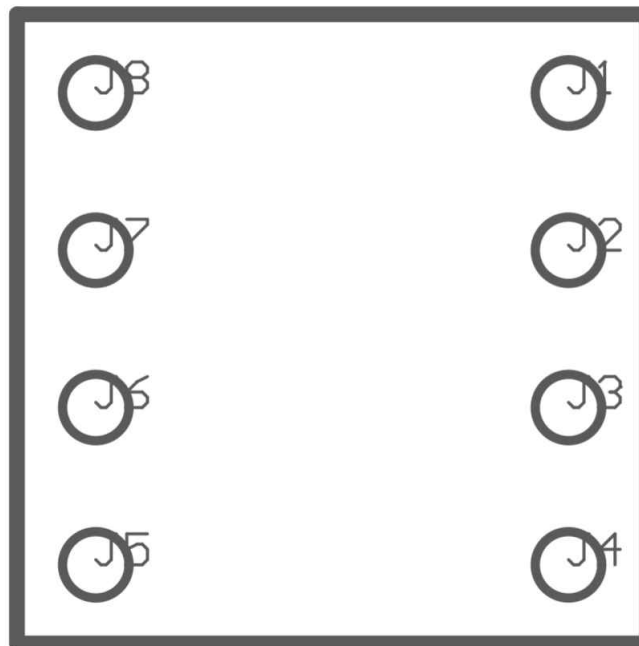


Figure 4-5. PCB Bottom-Layer Assembly Drawing

### 4.1.3 Bill of Materials

Table 4-1 lists the bill of materials for the OPT3004DTS coupon board.

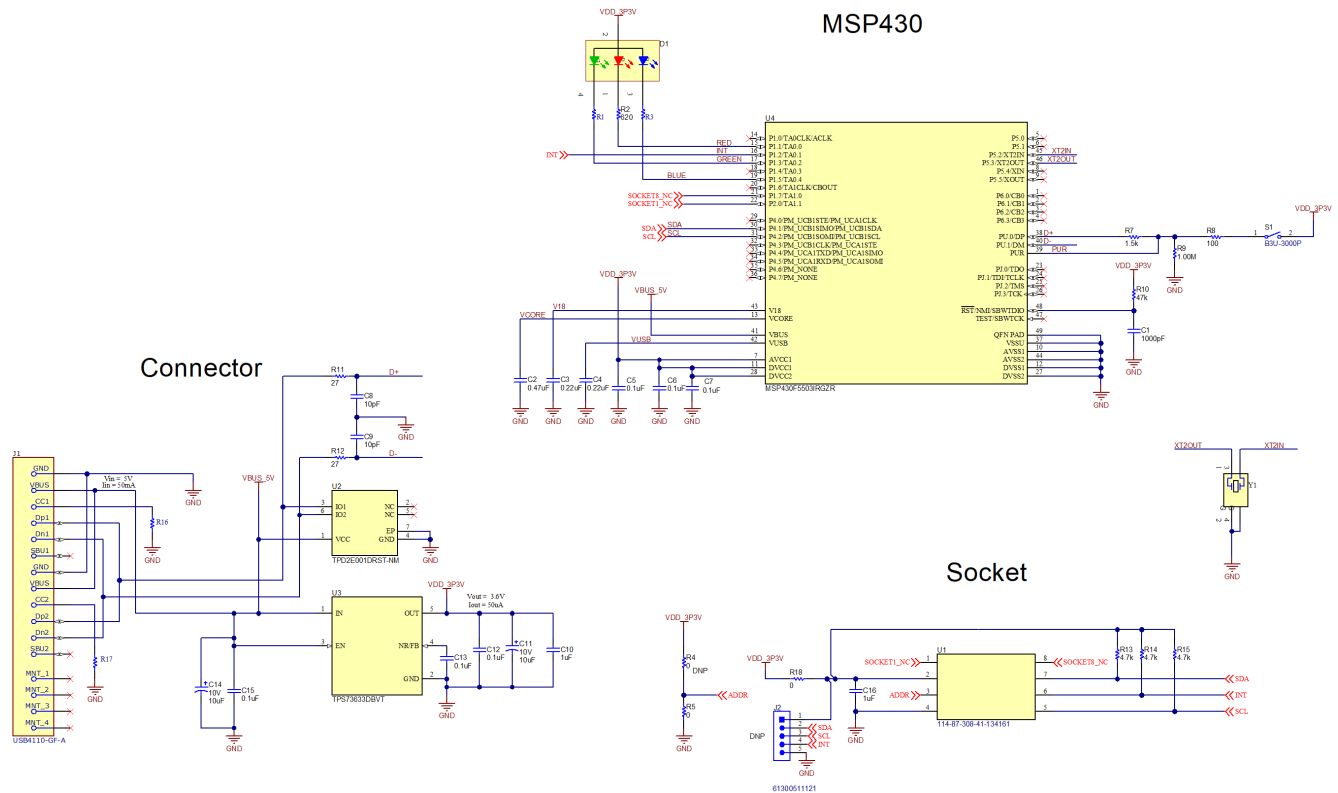
**Table 4-1. OPT3004DTS Coupon Bill of Materials**

Designator	Quantity	Description	PartNumber	Manufacturer
C1	1	CAP, CERM, 1 uF, 10 V, +/- 10%, X7S, AEC-Q200 Grade 1, 0402	GCM155C71A105KE38D	MuRata
J1, J2, J3, J4, J5, J6, J7, J8	8	PC Pin Terminal Connector Through Hole Gold 0.017" (0.43mm) Dia	3121-2-00-15-00-00-08-0	Mill-Max
U1	1	Ambient Light Sensor (ALS) With Excellent AngularIR Rejectio	OPT3004DTS	Texas Instruments

## 4.2 Motherboard

### 4.2.1 Schematic

Figure 4-1 shows the complete schematic of the OPTMBEVM motherboard. The schematic is split into three sections: connector, MSP430, and socket. A USB type C connector is used to interface with the PC. The MSP430 microcontroller allows the PC to interface with the OPT3004DTS through I2C. The coupon board containing the OPT3004DTS plugs into the motherboard through the socket. The OPTMBEVM board provides easy access to the I2C, INT, VDD, and GND lines. The header J2 is depopulated on the EVM by default and its labeled through hole pads can be used to access the lines. Alternatively, a header can be populated at J2 for easier access.



**Figure 4-6. OPTMBEVM Schematic**

## 4.2.2 PCB Layout

Figure 4-2 and Figure 4-3 show the top and bottom PCB layers, respectively, of the test board. Figure 4-4 and Figure 4-5 show the assembly drawings of the top and bottom PCB layers, respectively.

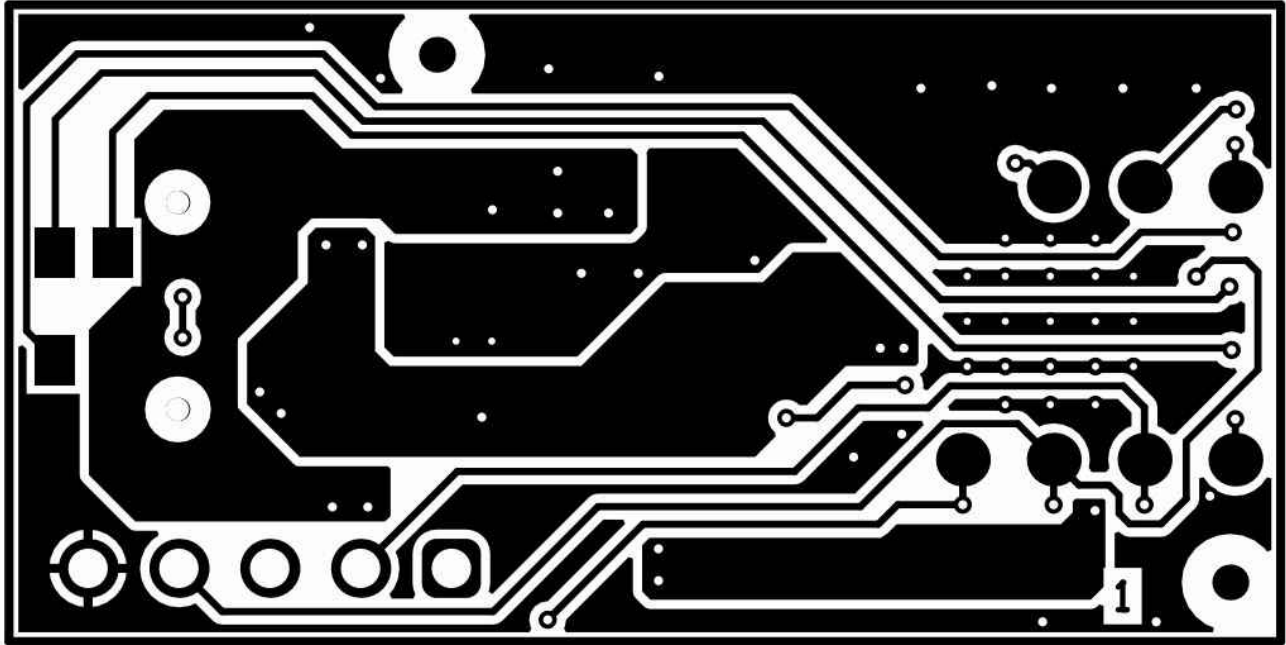


Figure 4-7. PCB Top Layer

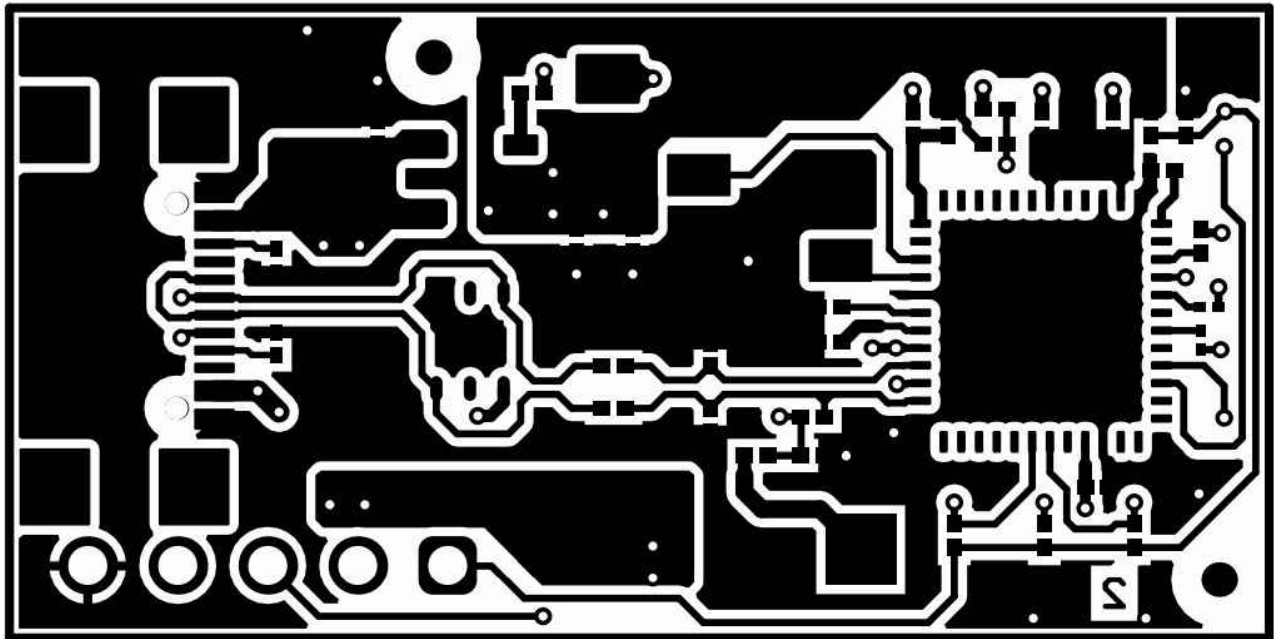


Figure 4-8. PCB Bottom Layer

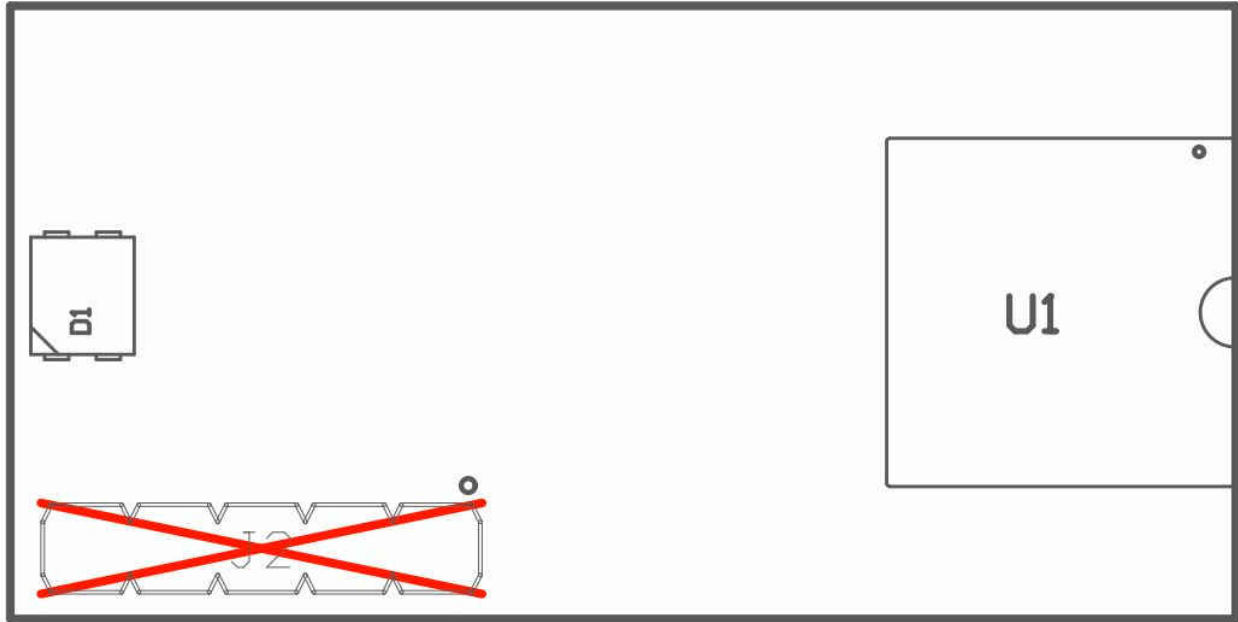


Figure 4-9. PCB Top-Layer Assembly Drawing

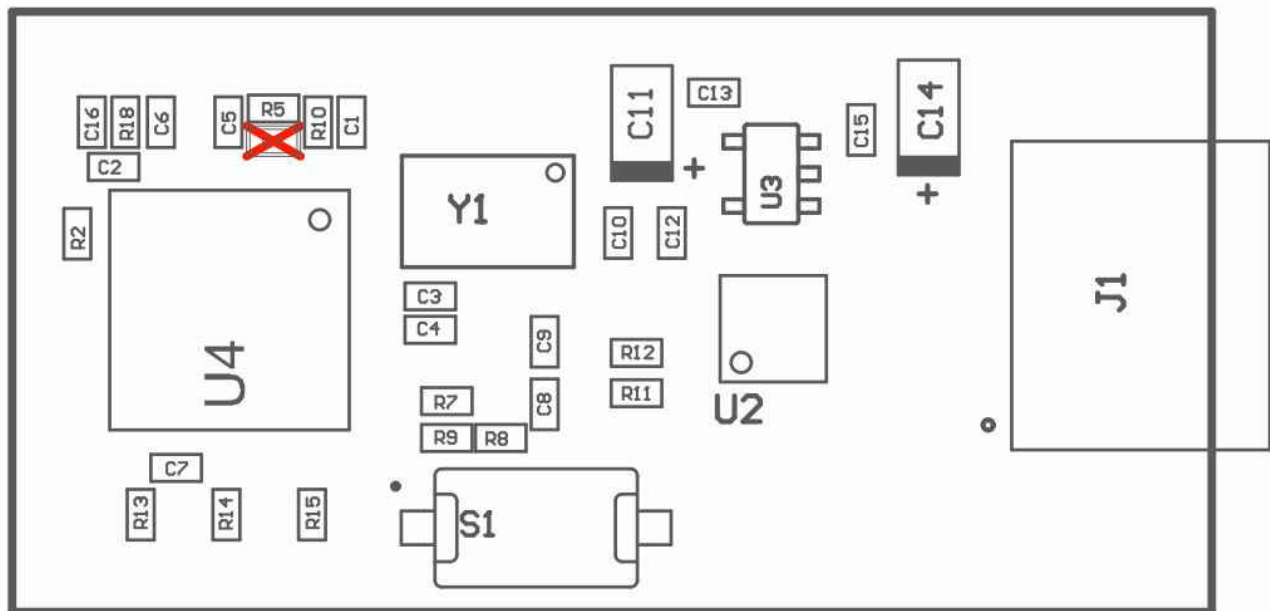


Figure 4-10. PCB Bottom-Layer Assembly Drawing



### 4.2.3 Bill of Materials

Table 4-2 lists the bill of materials for the OPTMBEVM motherboard.

**Table 4-2. OPTMBEVM Bill of Materials**

Designator	Quantity	Description	PartNumber	Manufacturer
C1	1	CAP, CERM, 1 uF, 10 V, +/- 10%, X7S, AEC-Q200 Grade 1, 0402	GCM155C71A105KE38D	MuRata
J1, J2, J3, J4, J5, J6, J7, J8	8	PC Pin Terminal Connector Through Hole Gold 0.017" (0.43mm) Dia	3121-2-00-15-00-00-08-0	Mill-Max
R2	1	RES, 620, 5%, 0.05 W, 0201	RC0201JR-07620RL	Yageo America
R5, R18	2	RES, 0, 5%, .05 W, AEC-Q200 Grade 0, 0201	ERJ-1GN0R00C	Panasonic
R7	1	RES, 1.5 k, 5%, 0.05 W, 0201	RC0201JR-071K5L	Yageo America
R8	1	RES, 100, 1%, 0.05 W, 0201	ERJ-1GEF1000C	Panasonic
R9	1	RES, 1.00 M, 1%, 0.05 W, AEC-Q200 Grade 0, 0201	RK73H1HTTC1004F	KOA Speer
R10	1	RES, 47 k, 5%, 0.05 W, 0201	RC0201JR-0747KL	Yageo America
R11, R12	2	RES, 27, 5%, 0.05 W, 0201	RC0201JR-0727RL	Yageo America
R13, R14, R15	3	RES, 4.7 k, 5%, 0.05 W, 0201	RC0201JR-074K7L	Yageo America
R16, R17	2	RES SMD 5.1K OHM 5% 1/20W 0201	CRCW02015K10JNED	Vishay Dale
S1	1	Switch, Tactile, SPST-NO, 0.05A, 12V, SMD	RS-032G05A3-SM RT	C&K Components
U1	1	Socket, DIP-8, 2.54 mm Pitch, SMT	114-87-308-41-134161	Preci-Dip
U2	1	Low-Capacitance + / - 15 kV ESD-Protection Array for High-Speed Data Interfaces, 2 Channels, -40 to +85 degC, 6-pin SON (DRS), Green (RoHS & no Sb/Br)	TPD2E001DRST-NM	Texas Instruments
U3	1	Single Output Low Noise LDO, 400 mA, Fixed 3.3 V Output, 1.7 to 5.5 V Input, with Reverse Current Protection, 5-pin SOT-23 (DBV), -40 to 85 degC, Green (RoHS & no Sb/Br)	TPS73633DBVT	Texas Instruments
U4	1	Mixed Signal Microcontroller, RGZ0048A (VQFN-48)	MSP430F5503IRGZR	Texas Instruments
Y1	1	Crystal, 24 MHz, 10 pF, SMD	ABM3B-24.000MHZ-10-1-U-T	Abracon Corporation
FID1, FID2, FID3, FID4	0	Fiducial mark. There is nothing to buy or mount.	N/A	N/A
J2	0	Header, 2.54mm, 5x1, Gold, TH	61300511121	Würth Elektronik

**Table 4-2. OPTMBEVM Bill of Materials (continued)**

<b>Designator</b>	<b>Quantity</b>	<b>Description</b>	<b>PartNumber</b>	<b>Manufacturer</b>
R4	0	RES, 0, 5%, .05 W, AEC-Q200 Grade 0, 0201	ERJ-1GN0R00C	Panasonic

## 5 Troubleshooting

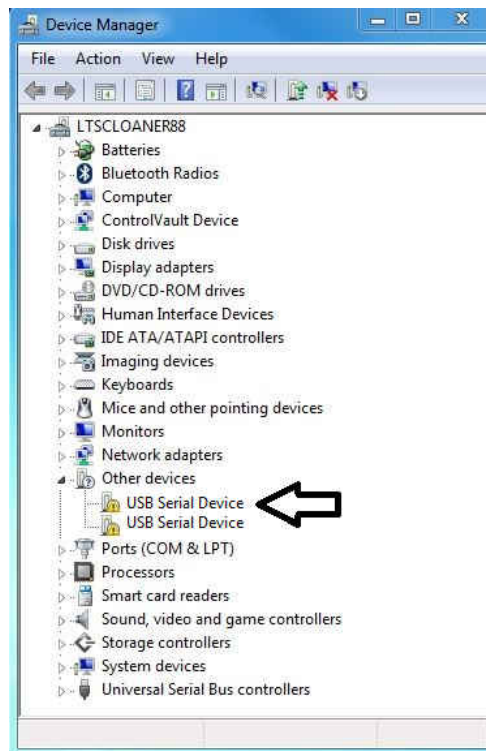
### 5.1 Microsoft Windows 7 Manual Driver Installation

This section outlines the manual driver installation process. If you are using Windows 7 or if the Windows device manager shows 2 USB Serial Devices under as *other devices* when the EVM is plugged in instead of COM ports as shown in [Figure 5-1](#), use the following steps. If two *USB Serial Device* devices show up as COM ports automatically (as is the case with Windows 10), then this section can be skipped.



**Figure 5-1. OPT3004DTSEVM on Microsoft® Windows® 7 With Drivers not Installed**

1. Open the device manager.

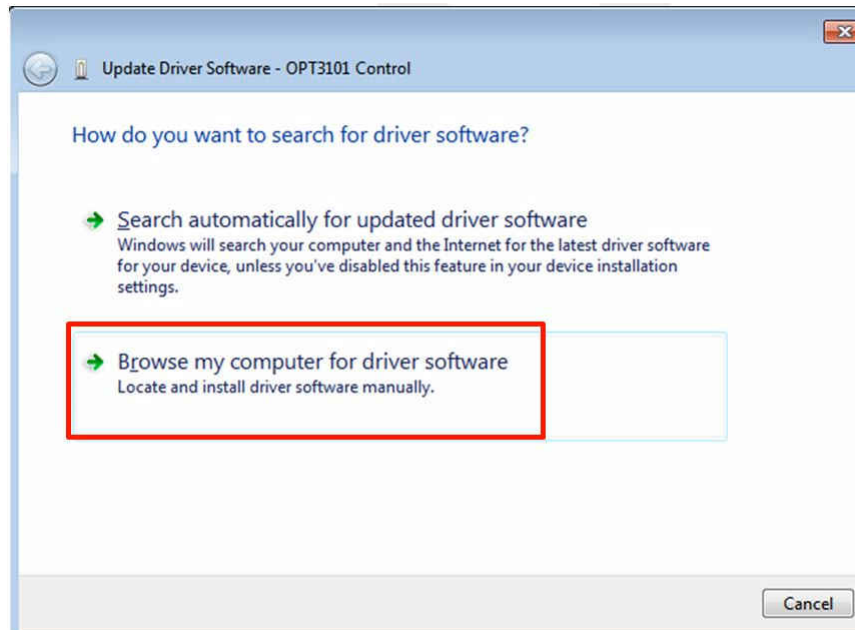


2. Right click on *USB Serial Device* and select Properties.

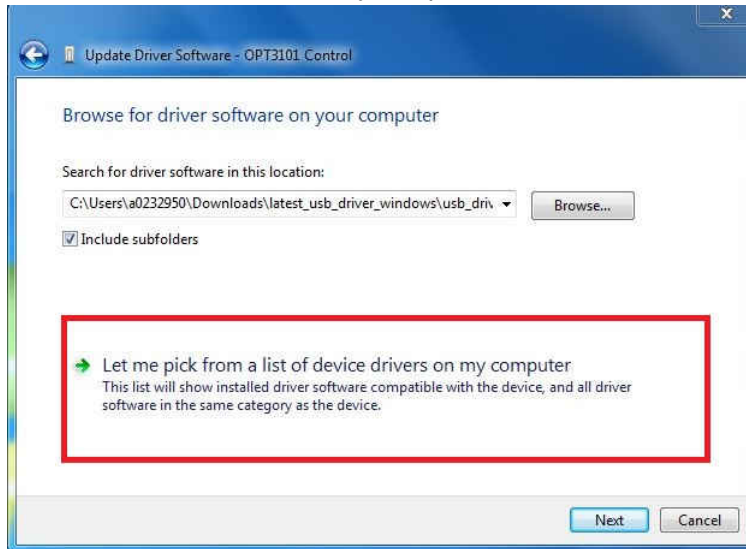
- Click the **Update Driver...** button.



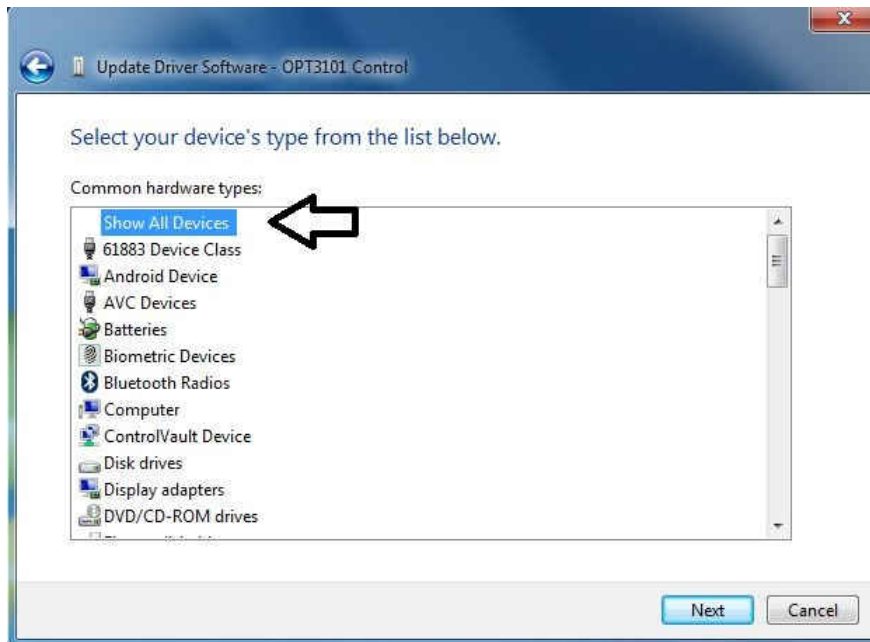
- Click *Browse my computer for driver software*



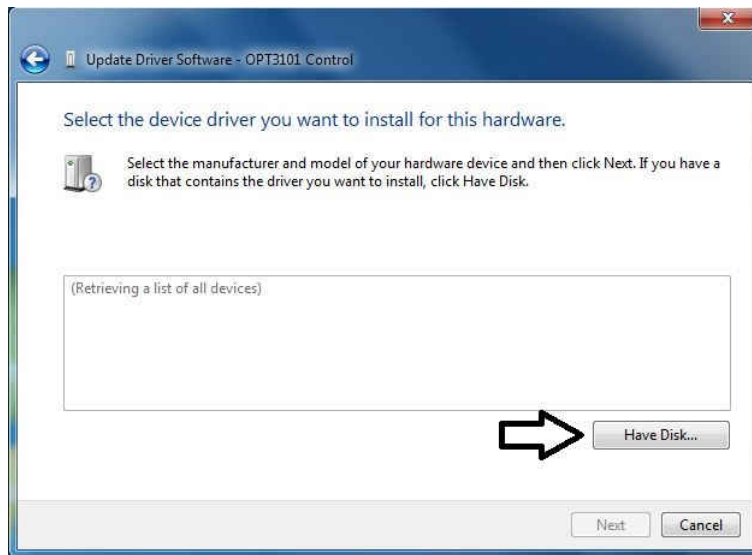
5. Click *Let me pick from a list of device drivers on my computer*.



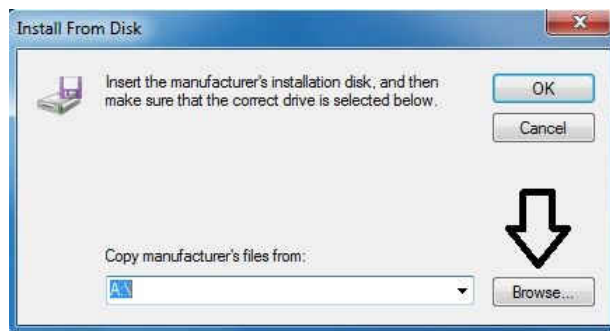
6. Select *Show All Devices* and click the **Next** button.



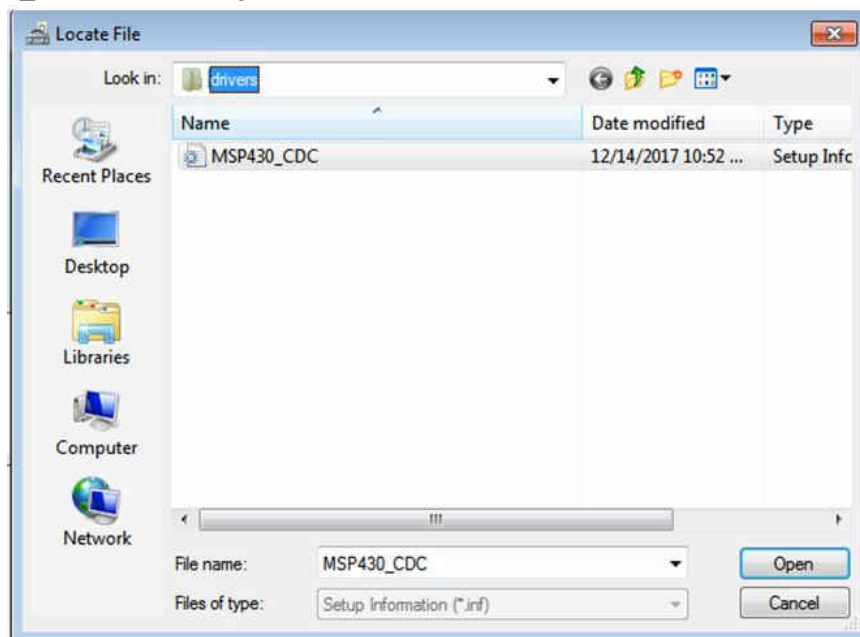
- Click the **Have Disk...** button.



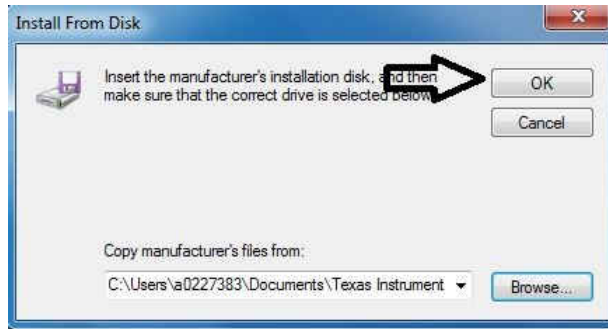
- Click the **Browse...** button.



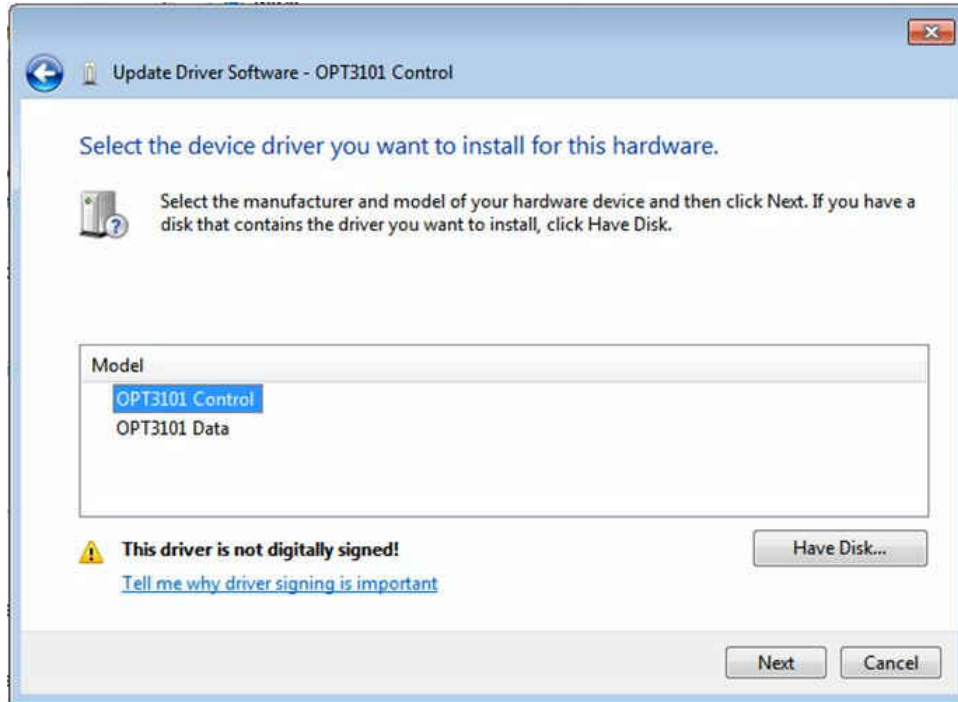
- Navigate to "C:\Users\\Documents\Texas Instruments\Latte\projects\OPT3004\drivers" and choose MSP430\_CDC. Click the **Open** button.



10. Click the **OK** button



11. Select the first *USB serial device* and click the **Next** button.



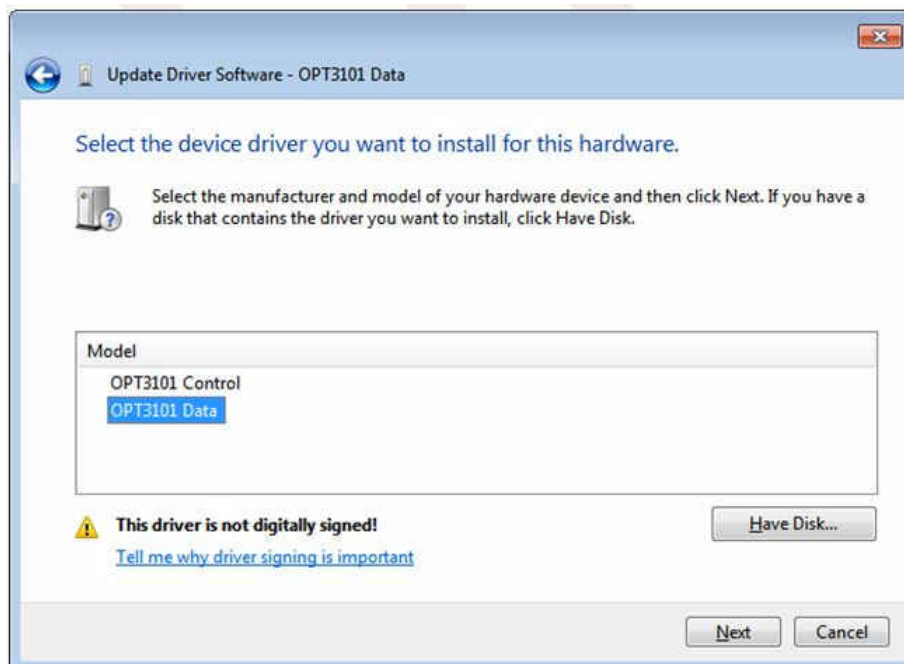
12. Click the **Yes** button.



13. The driver should now install properly.

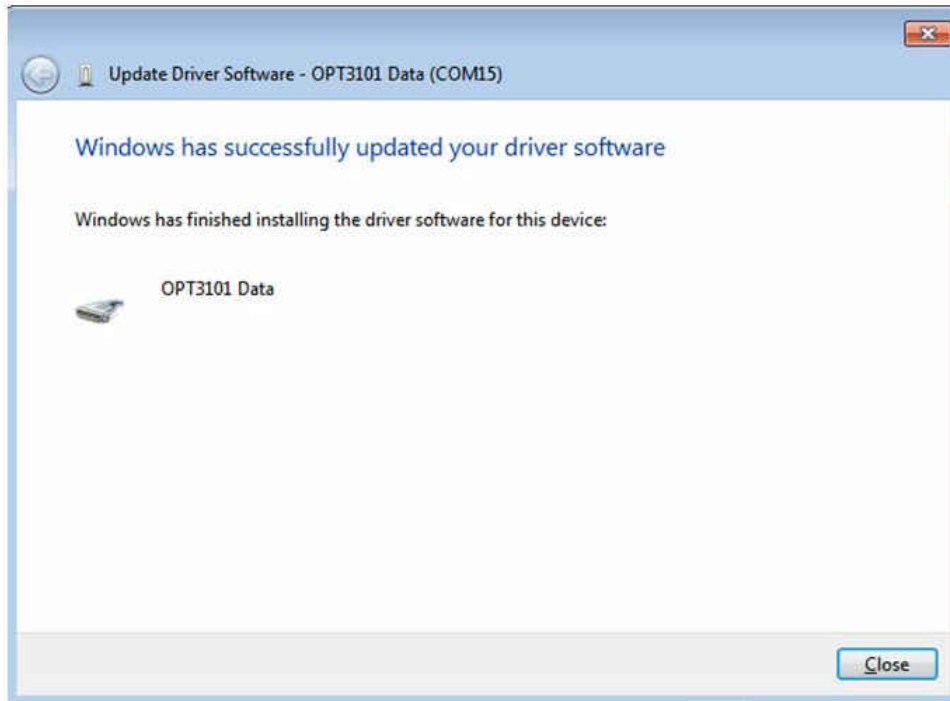


14. Now repeat this process (steps 1 to 13) for the second *USB Serial Device*. All steps are the same except for step 2 and step 11. In step 2 make sure to right click the second *USB Serial Device*. Likewise, on step 11 make sure to select the second *USB Serial Device* when installing the driver as the following figure shows.

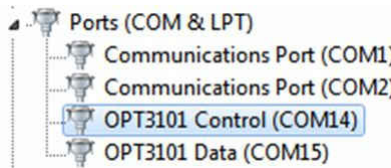




15. When the driver is installed, you will see the following message.



16. The two *USB Serial Device* devices should now appear in the device manager under Ports (COM & LPT) as the following image shows.



## 6 Revision History

NOTE: Page numbers for previous revisions may differ from page numbers in the current version.

Changes from Revision * (December 2021) to Revision A (January 2022)	Page
• Changed <a href="#">Figure 3-12</a> .....	13
• Updated <a href="#">Figure 3-14</a> image to fit on the page.....	16

## IMPORTANT NOTICE AND DISCLAIMER

TI PROVIDES TECHNICAL AND RELIABILITY DATA (INCLUDING DATA SHEETS), DESIGN RESOURCES (INCLUDING REFERENCE DESIGNS), APPLICATION OR OTHER DESIGN ADVICE, WEB TOOLS, SAFETY INFORMATION, AND OTHER RESOURCES "AS IS" AND WITH ALL FAULTS, AND DISCLAIMS ALL WARRANTIES, EXPRESS AND IMPLIED, INCLUDING WITHOUT LIMITATION ANY IMPLIED WARRANTIES OF MERCHANTABILITY, FITNESS FOR A PARTICULAR PURPOSE OR NON-INFRINGEMENT OF THIRD PARTY INTELLECTUAL PROPERTY RIGHTS.

These resources are intended for skilled developers designing with TI products. You are solely responsible for (1) selecting the appropriate TI products for your application, (2) designing, validating and testing your application, and (3) ensuring your application meets applicable standards, and any other safety, security, regulatory or other requirements.

These resources are subject to change without notice. TI grants you permission to use these resources only for development of an application that uses the TI products described in the resource. Other reproduction and display of these resources is prohibited. No license is granted to any other TI intellectual property right or to any third party intellectual property right. TI disclaims responsibility for, and you will fully indemnify TI and its representatives against, any claims, damages, costs, losses, and liabilities arising out of your use of these resources.

TI's products are provided subject to [TI's Terms of Sale](#) or other applicable terms available either on [ti.com](http://ti.com) or provided in conjunction with such TI products. TI's provision of these resources does not expand or otherwise alter TI's applicable warranties or warranty disclaimers for TI products.

TI objects to and rejects any additional or different terms you may have proposed.

Mailing Address: Texas Instruments, Post Office Box 655303, Dallas, Texas 75265  
Copyright © 2022, Texas Instruments Incorporated