

# TPS745-Q1 Automotive, 500-mA LDO With Power-Good in Small Wettable Flank WSON Packages

## 1 Features

- AEC-Q100 qualified for automotive applications:
  - Temperature grade 1:  $-40^{\circ}\text{C}$  to  $+125^{\circ}\text{C}$ ,  $T_A$
- Device junction temperature:  $-40^{\circ}\text{C}$  to  $150^{\circ}\text{C}$
- Package:
  - 2-mm  $\times$  2-mm wettable flank WSON
  - 3-mm  $\times$  3-mm wettable flank VSON
- Input voltage range: 1.5 V to 6.0 V
- Output voltage range:
  - Fixed option: 0.65 V to 5.0 V
  - Adjustable option: 0.55 V to 5.5 V
- High PSRR: 45 dB at 100 kHz
- Output accuracy:  $\pm 0.85\%$  ( $25^{\circ}\text{C}$ ),  $\pm 1.5\%$  maximum
- Power-good output options:
  - Open-drain and push-pull
- Ultra-low dropout:
  - 160 mV (max) at 500 mA ( $3.3 V_{\text{OUT}}$ )
- Stable with a 1- $\mu\text{F}$  or larger capacitor
- Low  $I_Q$ : 25  $\mu\text{A}$  (typical), 1.5  $\mu\text{A}$  (shutdown)
- Active output discharge
- [Functional Safety-Capable](#)
  - [Documentation available to aid functional safety system design](#)
- Low thermal resistance:
  - DRV (6-pin WSON),  $R_{\theta\text{JA}} = 80.3^{\circ}\text{C/W}$
  - DRB (8-pin VSON),  $R_{\theta\text{JA}} = 55.5^{\circ}\text{C/W}$

## 2 Applications

- [Automotive head units](#)
- [Front and rear cameras](#)
- [Automotive cluster displays](#)
- [Telematics control units](#)
- [Medium, short range radar](#)

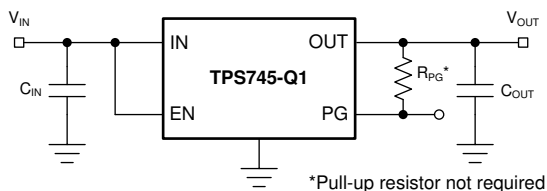

**Typical Application: Fixed Voltage Version**

## 3 Description

The TPS745-Q1 is a 500-mA ultra-low-dropout regulator (LDO) with power-good functionality. This device is available in a small 6-pin, 2-mm  $\times$  2-mm WSON package and a small 8-pin, 3-mm  $\times$  3-mm VSON package with wettable flanks to facilitate optical inspection. The TPS745-Q1 consumes low quiescent current and provides fast line and load transient performance.

The TPS745-Q1 is a flexible device for post-regulation by supporting an input voltage range from 1.5 V to 6.0 V and an externally adjustable output range of 0.55 V to 5.5 V. The device also features fixed output voltages for powering common voltage rails.

The TPS745-Q1 has a power-good (PG) output that monitors the voltage at the feedback pin to indicate the status of the output voltage. The EN input and PG output can be used for sequencing multiple power supplies in the system.

The TPS745-Q1 is stable with small ceramic output capacitors, allowing for a small overall solution size. A precision band-gap and error amplifier provides high accuracy of  $\pm 0.85\%$  (max) at  $25^{\circ}\text{C}$  and  $\pm 1.5\%$  (max) over temperature. This device includes integrated thermal shutdown, current limit, and undervoltage lockout (UVLO) features. The TPS745-Q1 has an internal foldback current limit that helps reduce the thermal dissipation during short-circuit events.

### Device Information<sup>(1)</sup>

PART NUMBER	PACKAGE	BODY SIZE (NOM)
TPS745-Q1	Wettable flank WSON (6)	2.00 mm $\times$ 2.00 mm
	Wettable flank VSON (8)	3.00 mm $\times$ 3.00 mm

- (1) For all available packages, see the orderable addendum at the end of the data sheet.

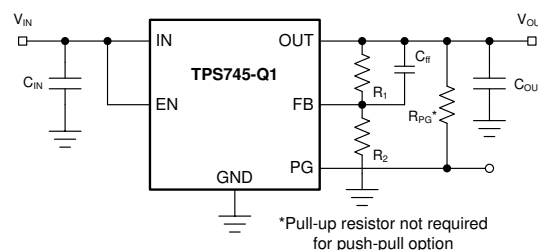

**Typical Application: Adjustable Voltage Version**



## Table of Contents

<b>1 Features</b> .....	1	7.4 Device Functional Modes.....	19
<b>2 Applications</b> .....	1	<b>8 Application and Implementation</b> .....	20
<b>3 Description</b> .....	1	8.1 Application Information.....	20
<b>4 Revision History</b> .....	2	8.2 Typical Application.....	27
<b>5 Pin Configuration and Functions</b> .....	3	<b>9 Power Supply Recommendations</b> .....	28
<b>6 Specifications</b> .....	4	<b>10 Layout</b> .....	29
6.1 Absolute Maximum Ratings.....	4	10.1 Layout Guidelines.....	29
6.2 ESD Ratings.....	4	10.2 Layout Examples.....	29
6.3 Recommended Operating Conditions.....	4	<b>11 Device and Documentation Support</b> .....	30
6.4 Thermal Information.....	5	11.1 Device Support.....	30
6.5 Electrical Characteristics.....	5	11.2 Documentation Support.....	30
6.6 Timing Requirements.....	6	11.3 Receiving Notification of Documentation Updates..	30
6.7 Typical Characteristics.....	7	11.4 Support Resources.....	30
<b>7 Detailed Description</b> .....	15	11.5 Trademarks.....	30
7.1 Overview.....	15	11.6 Electrostatic Discharge Caution.....	30
7.2 Functional Block Diagrams.....	15	11.7 Glossary.....	31
7.3 Feature Description.....	17		

## 4 Revision History

NOTE: Page numbers for previous revisions may differ from page numbers in the current version.

<b>Changes from Revision B (January 2021) to Revision C (May 2022)</b>	<b>Page</b>
• Changed DRB $R_{\theta JA}$ from $62.0^{\circ}\text{C/W}$ to $55.5^{\circ}\text{C/W}$ and added Functional Safety Bullet.....	1
• Changed WSON to VSON for DRB package throughout document.....	1
• Updated thermal table to reflect correct values and package name.....	5

<b>Changes from Revision A (October 2019) to Revision B (January 2021)</b>	<b>Page</b>
• Changed DRB package from preview to production data.....	1
• Added limits to $I_{SC}$ and $t_{STR}$ .....	5
• Changed $V_{DO}$ and $V_{OL(PG)}$ conditions to correct values.....	5

## 5 Pin Configuration and Functions

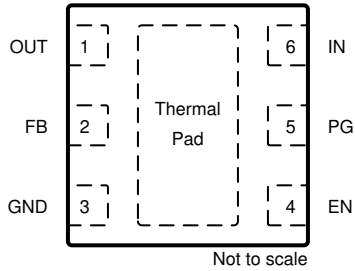

**Figure 5-1. DRV Package, 6-Pin Adjustable WSON (Top View)**

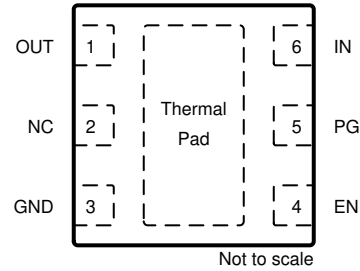

**Figure 5-2. DRV Package, 6-Pin Fixed WSON (Top View)**

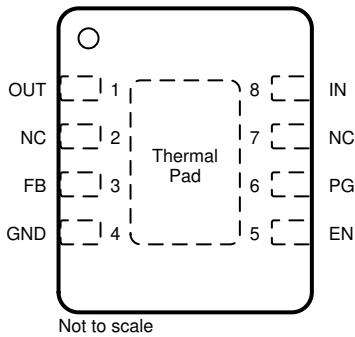

**Figure 5-3. DRB Package, 8-Pin Adjustable VSON (Top View)**

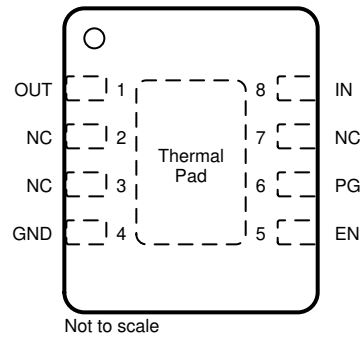

**Figure 5-4. DRB Package, 8-Pin Fixed VSON (Top View)**

**Table 5-1. Pin Functions**

NAME	PIN				I/O	DESCRIPTION
	DRV (Fixed)	DRV (Adjust)	DRB (Fixed)	DRB (Adjust)		
EN	4	4	5	5	Input	Enable pin. Drive EN greater than $V_{EN(HI)}$ to turn on the regulator. Drive EN less than $V_{EN(LO)}$ to put the low-dropout regulator (LDO) into shutdown mode.
FB	—	2	—	3	—	This pin is used as an input to the control loop error amplifier and is used to set the output voltage of the LDO.
GND	3	3	4	4	—	Ground pin.
IN	6	6	8	8	Input	Input pin. For best transient response and to minimize input impedance, use the recommended value or larger ceramic capacitor from IN to ground as listed in the <a href="#">Recommended Operating Conditions</a> table and the <a href="#">Input and Output Capacitor Selection</a> section. Place the input capacitor as close to the output of the device as possible.
NC	2	—	2, 3, 7	2, 7	—	No internal connection. Ground this pin for better thermal performance.
OUT	1	1	1	1	Output	Regulated output voltage pin. A capacitor is required from OUT to ground for stability. For best transient response, use the nominal recommended value or larger ceramic capacitor from OUT to ground; see the <a href="#">Recommended Operating Conditions</a> table and the <a href="#">Input and Output Capacitor Selection</a> section. Place the output capacitor as close to output of the device as possible.
PG	5	5	6	6	Output	Power-good output. Available in open-drain and push-pull topologies. A pullup resistor is only required for the open-drain type. For the open-drain version, if the power-good functionality is not being used, ground this pin or leave floating. For the push-pull version, if the power-good functionality is not being used, leave this pin floating.
Thermal Pad					—	The thermal pad is electrically connected to the GND node. Connect to the GND plane for improved thermal performance.

## 6 Specifications

### 6.1 Absolute Maximum Ratings

over operating free-air temperature range (unless otherwise noted)<sup>(1)</sup>

		MIN	MAX	UNIT
Voltage	Supply, $V_{IN}$	-0.3	6.5	V
	Enable, $V_{EN}$	-0.3	6.5	
	Feedback, $V_{FB}$	-0.3	2.0	
	Power-good, $V_{PG}$	-0.3	6.5	
	Output, $V_{OUT}$	-0.3	$V_{IN} + 0.3$ <sup>(2)</sup>	
Current	Output, $I_{OUT}$	Internally limited		
	Power-good, $I_{PG}$		±10	mA
Temperature	Operating junction, $T_J$	-40	150	°C
	Storage, $T_{stg}$	-65	150	

- (1) Stresses beyond those listed under *Absolute Maximum Ratings* may cause permanent damage to the device. These are stress ratings only, which do not imply functional operation of the device at these or any other conditions beyond those indicated under *Recommended Operating Conditions*. Exposure to absolute-maximum-rated conditions for extended periods may affect device reliability.
- (2) The absolute maximum rating is  $V_{IN} + 0.3$  V or 6.0 V, whichever is smaller.

### 6.2 ESD Ratings

		VALUE	UNIT	
$V_{(ESD)}$	Electrostatic discharge	Human-body model (HBM), per AEC Q100-002 <sup>(1)</sup>	±2000	V
		Charged-device model (CDM), per AEC Q100-011, corner pins	±750	
		Charged-device model (CDM), per AEC Q100-011, other pins	±500	

- (1) AEC Q100-002 indicates that HBM stressing shall be in accordance with the ANSI/ESDA/JEDEC JS-001 specification.

### 6.3 Recommended Operating Conditions

over operating free-air temperature range (unless otherwise noted)

		MIN	NOM	MAX	UNIT
$V_{IN}$	Input voltage	1.5		6.0	V
$V_{OUT}$	Output voltage	Adjustable only		5.5	V
		Fixed only	0.65	5.0	
$I_{OUT}$	Output current	0		500	mA
$C_{IN}$	Input capacitor	1			µF
$C_{OUT}$	Output capacitor <sup>(1)</sup>	1		220	µF
$C_{FF}$	Feed-forward capacitor		10		nF
$V_{EN}$	Enable voltage	0		6.0	V
$f_{EN}$	Enable toggle frequency			10	kHz
$V_{PG}$	PG voltage	0		6.0	V
$T_J$	Junction operating temperature	-40		150	°C

- (1) Minimum derated capacitance of 0.47 µF is required for stability.

## 6.4 Thermal Information

THERMAL METRIC <sup>(1)</sup>		TPS745-Q1		UNIT
		DRV (WSON)	DRB (VSON)	
		6 PINS	8 PINS	
R <sub>θJA</sub>	Junction-to-ambient thermal resistance	80.3	55.5	°C/W
R <sub>θJC(top)</sub>	Junction-to-case (top) thermal resistance	98.7	70.7	°C/W
R <sub>θJB</sub>	Junction-to-board thermal resistance	44.8	28.0	°C/W
ψ <sub>JT</sub>	Junction-to-top characterization parameter	6.1	4.3	°C/W
ψ <sub>JB</sub>	Junction-to-board characterization parameter	45.0	28.0	°C/W
R <sub>θJC(bot)</sub>	Junction-to-case (bottom) thermal resistance	20.8	10.2	°C/W

(1) For more information about traditional and new thermal metrics, see the [Semiconductor and IC Package Thermal Metrics](#) application report.

## 6.5 Electrical Characteristics

at operating temperature range ( $T_J = -40^\circ\text{C}$  to  $+150^\circ\text{C}$ ),  $V_{IN} = V_{OUT(NOM)} + 0.5\text{ V}$  or  $1.5\text{ V}$  (whichever is greater),  $I_{OUT} = 1\text{ mA}$ ,  $V_{EN} = V_{IN}$ , and  $C_{IN} = C_{OUT} = 1\text{ }\mu\text{F}$ , unless otherwise noted; all typical values are at  $T_J = 25^\circ\text{C}$

PARAMETER	TEST CONDITIONS	MIN	TYP	MAX	UNIT		
V <sub>FB</sub>	Feedback voltage	Adjustable only		0.55	V		
	Output accuracy <sup>(1)</sup>	T <sub>J</sub> = 25°C		-0.85%	0.85%		
		-40°C ≤ T <sub>J</sub> ≤ 85°C		-1.00%	1.00%		
		-40°C ≤ T <sub>J</sub> ≤ 150°C		-1.50%	1.50%		
	Line regulation	V <sub>OUT(NOM)</sub> + 0.5 V <sup>(2)</sup> ≤ V <sub>IN</sub> ≤ 6.0 V		2	7.5		
	Load regulation	0.1 mA ≤ I <sub>OUT</sub> ≤ 500 mA, V <sub>IN</sub> ≥ 2.0 V		0.030	V/A		
I <sub>GND</sub>	Ground current	I <sub>OUT</sub> = 0 mA	T <sub>J</sub> = 25°C	25	32	μA	
			-40°C ≤ T <sub>J</sub> ≤ 150°C	25	36		
I <sub>SHDN</sub>	Shutdown current	V <sub>EN</sub> ≤ 0.3 V, 1.5 V ≤ V <sub>IN</sub> ≤ 6.0 V	-40°C ≤ T <sub>J</sub> ≤ 125°C	0.1	1	μA	
			-40°C ≤ T <sub>J</sub> ≤ 150°C	0.1	1.55		
I <sub>FB</sub>	Feedback pin current	Adjustable only		0.01	0.1		
I <sub>CL</sub>	Output current limit	V <sub>OUT(NOM)</sub> < 1.0 V, V <sub>OUT</sub> = V <sub>OUT(NOM)</sub> - 0.2 V, V <sub>IN</sub> = 2.0 V		515	720	865	mA
		V <sub>OUT(NOM)</sub> ≥ 1.0 V, V <sub>OUT</sub> = V <sub>OUT(NOM)</sub> × 0.85, V <sub>IN</sub> = V <sub>OUT(NOM)</sub> + 1.0 V					
I <sub>SC</sub>	Short-circuit current limit	V <sub>OUT</sub> = 0 V	V <sub>OUT(NOM)</sub> < 1.0 V, V <sub>IN</sub> = 2.0 V	200	350	400	mA
			V <sub>OUT(NOM)</sub> ≥ 1.0 V, V <sub>IN</sub> = V <sub>OUT(NOM)</sub> + 1.0 V				
V <sub>DO</sub>	Dropout voltage	I <sub>OUT</sub> = 500 mA, V <sub>OUT</sub> = 0.95 × V <sub>OUT(NOM)</sub>	0.65 V ≤ V <sub>OUT</sub> < 0.8 V <sup>(3)</sup>	720	910	mV	
			0.8 V ≤ V <sub>OUT</sub> < 1.0 V	585	780		
			1.0 V ≤ V <sub>OUT</sub> < 1.2 V	420	600		
			1.2 V ≤ V <sub>OUT</sub> < 1.5 V	285	430		
			1.5 V ≤ V <sub>OUT</sub> < 1.8 V	180	265		
			1.8 V ≤ V <sub>OUT</sub> < 2.5 V	140	215		
			2.5 V ≤ V <sub>OUT</sub> < 3.3 V	105	170		
3.3 V ≤ V <sub>OUT</sub> ≤ 5.5 V	95	160					
PSRR	Power-supply rejection ratio	V <sub>OUT</sub> = 1.8 V, V <sub>IN</sub> = 2.8 V, I <sub>OUT</sub> = 500 mA, C <sub>OUT</sub> = 2.2 μF	f = 1 kHz	57	dB		
			f = 100 kHz	42			
			f = 1 MHz	35			
V <sub>N</sub>	Output noise voltage	BW = 10 Hz to 100 kHz, V <sub>OUT</sub> = 0.9 V, V <sub>IN</sub> = 1.9 V		53	μV <sub>RMS</sub>		
V <sub>UVLO</sub>	Undervoltage lockout	V <sub>IN</sub> falling	1.17	1.30	1.42	V	
		V <sub>IN</sub> rising	1.21	1.34	1.47		
V <sub>UVLO,HYST</sub>	Undervoltage lockout hysteresis	V <sub>IN</sub> hysteresis		40	mV		
t <sub>STR</sub>	Startup time	From EN low-to-high transition to V <sub>OUT</sub> = V <sub>OUT(NOM)</sub> × 0.95		200	500	650	μs

## 6.5 Electrical Characteristics (continued)

at operating temperature range ( $T_J = -40^\circ\text{C}$  to  $+150^\circ\text{C}$ ),  $V_{IN} = V_{OUT(NOM)} + 0.5\text{ V}$  or  $1.5\text{ V}$  (whichever is greater),  $I_{OUT} = 1\text{ mA}$ ,  $V_{EN} = V_{IN}$ , and  $C_{IN} = C_{OUT} = 1\text{ }\mu\text{F}$ , unless otherwise noted; all typical values are at  $T_J = 25^\circ\text{C}$

PARAMETER		TEST CONDITIONS	MIN	TYP	MAX	UNIT
$V_{EN(HI)}$	EN pin high voltage (enabled)		1.0			V
$V_{EN(LO)}$	EN pin low voltage (disabled)				0.3	V
$I_{EN}$	Enable pin current	$V_{IN} = V_{EN} = 6.0\text{ V}$		10		nA
$R_{PULLDOWN}$	Pulldown resistance	$V_{IN} = 6.0\text{ V}$		95		$\Omega$
$PG_{HTH}$	PG high threshold	$V_{OUT}$ increasing	89	92	96	$\%V_{OUT}$
$PG_{LTH}$	PG low threshold	$V_{OUT}$ decreasing	86	90	93	$\%V_{OUT}$
$PG_{HYST}$	PG hysteresis			2		$\%V_{out}$
$V_{OL(PG)}$	PG pin low-level output voltage	$V_{IN} \geq 1.5\text{ V}$ , $I_{SINK} = 1.0\text{ mA}$			300	mV
		$V_{IN} \geq 2.75\text{ V}$ , $I_{SINK} = 2.0\text{ mA}$				
$V_{OH(PG)}$	PG pin high-level output voltage <sup>(4)</sup>	$V_{OUT} \geq 1.0\text{ V}$ , $I_{SOURCE} = 0.04\text{ mA}$	0.8 x $V_{OUT}$			V
		$V_{OUT} \geq 1.4\text{ V}$ , $I_{SOURCE} = 0.2\text{ mA}$				
		$V_{OUT} \geq 2.5\text{ V}$ , $I_{SOURCE} = 0.5\text{ mA}$				
		$V_{OUT} \geq 4.5\text{ V}$ , $I_{SOURCE} = 1.0\text{ mA}$				
$I_{kg(PG)}$	PG pin leakage current <sup>(5)</sup>	$V_{OUT} > PG_{HTH}$ , $V_{PG} = 6.0\text{ V}$		7	50	nA
$T_{SD}$	Thermal shutdown	Shutdown, temperature increasing		170		$^\circ\text{C}$
		Reset, temperature decreasing		155		

- (1) When the device is connected to external feedback resistors at the FB pin, external resistor tolerances are not included.
- (2)  $V_{IN} = 1.5\text{ V}$  for  $V_{OUT} < 1.0\text{ V}$ .
- (3) Dropout is not tested for nominal output voltages below  $0.65\text{ V}$  since the input voltage may be below UVLO.
- (4) Push-pull version only. The push-pull option is supported only for  $V_{OUT} \geq 1.0\text{ V}$ .
- (5) Open-drain version only.

## 6.6 Timing Requirements

Parameter		MIN	TYP	MAX	UNIT
$t_{PGDH}$	PG delay time rising, time from 92% $V_{OUT}$ to 20% of PG <sup>(1)</sup>	135	165	178	$\mu\text{s}$
	'B' version <sup>(2)</sup>	4.5	5	5.5	ms
$t_{PGDL}$	PG delay time falling, time from 90% $V_{OUT}$ to 80% of PG <sup>(1)</sup>	1.5	7	10	$\mu\text{s}$

- (1) Output overdrive = 10%.
- (2) See the Device Nomenclature table for more information on available PG timings.

## 6.7 Typical Characteristics

at operating temperature range  $T_J = 25^\circ\text{C}$ ,  $V_{IN} = V_{OUT(NOM)} + 0.5\text{ V}$  or  $1.5\text{ V}$  (whichever is greater),  $I_{OUT} = 1\text{ mA}$ ,  $V_{EN} = V_{IN}$ , and  $C_{IN} = C_{OUT} = 1\ \mu\text{F}$  (unless otherwise noted)

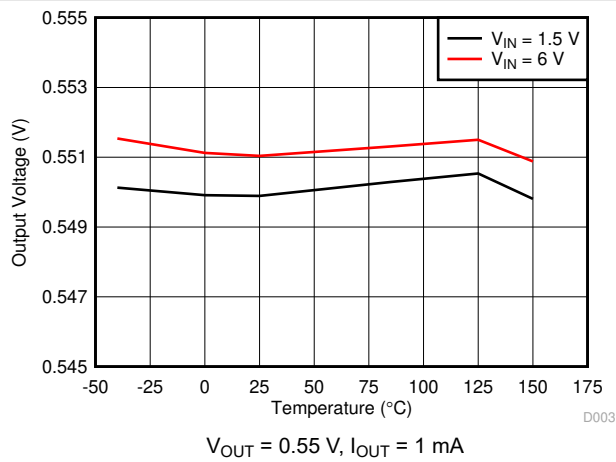

Figure 6-1. Output Voltage vs Ambient Temperature

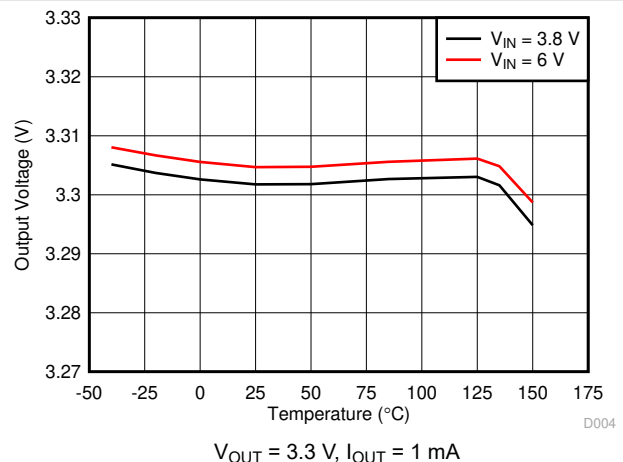

Figure 6-2. Output Voltage vs Ambient Temperature

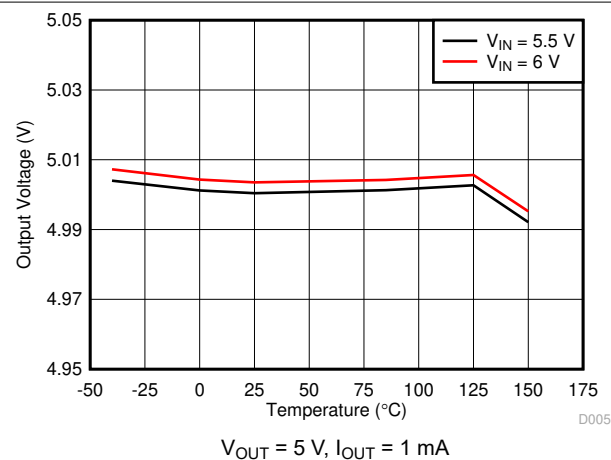

Figure 6-3. Output Voltage vs Ambient Temperature

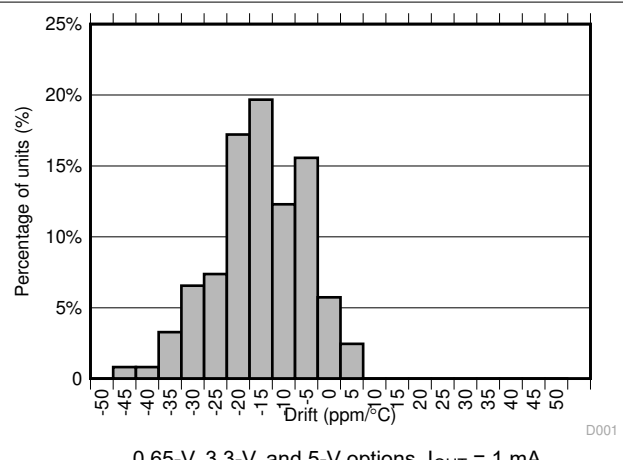

Figure 6-4. Temperature Drift Histogram ( $-40^\circ\text{C}$  to  $+25^\circ\text{C}$ )

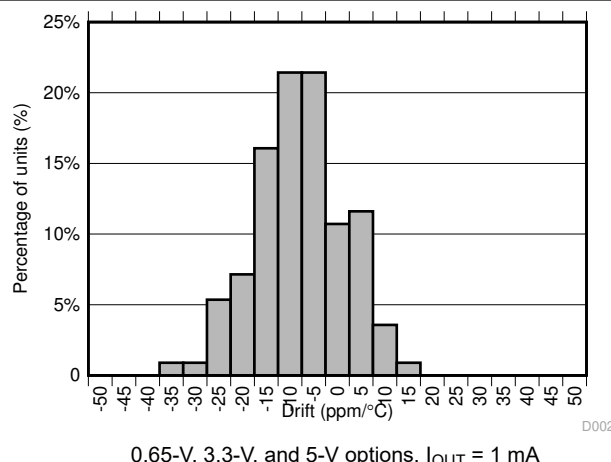

Figure 6-5. Temperature Drift Histogram ( $25^\circ\text{C}$  to  $150^\circ\text{C}$ )

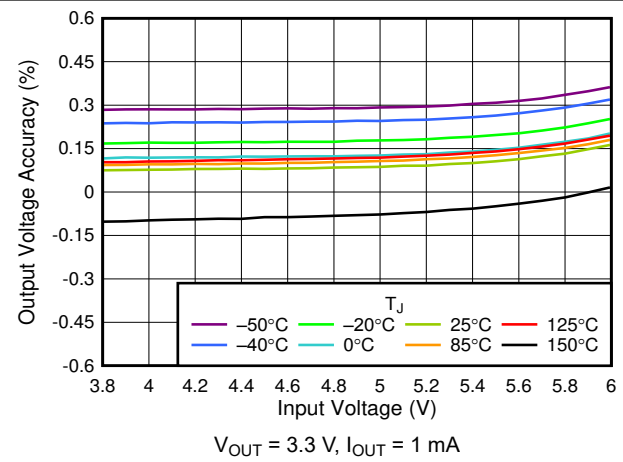
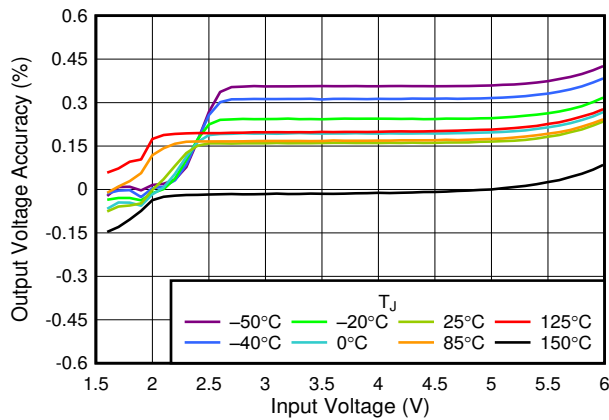

Figure 6-6. 3.3-V Line Regulation vs  $V_{IN}$

### 6.7 Typical Characteristics (continued)

at operating temperature range  $T_J = 25^\circ\text{C}$ ,  $V_{IN} = V_{OUT(NOM)} + 0.5\text{ V}$  or  $1.5\text{ V}$  (whichever is greater),  $I_{OUT} = 1\text{ mA}$ ,  $V_{EN} = V_{IN}$ , and  $C_{IN} = C_{OUT} = 1\text{ }\mu\text{F}$  (unless otherwise noted)



$V_{OUT} = 0.55\text{ V}$ ,  $I_{OUT} = 1\text{ mA}$

Figure 6-7. 0.55-V Line Regulation vs  $V_{IN}$

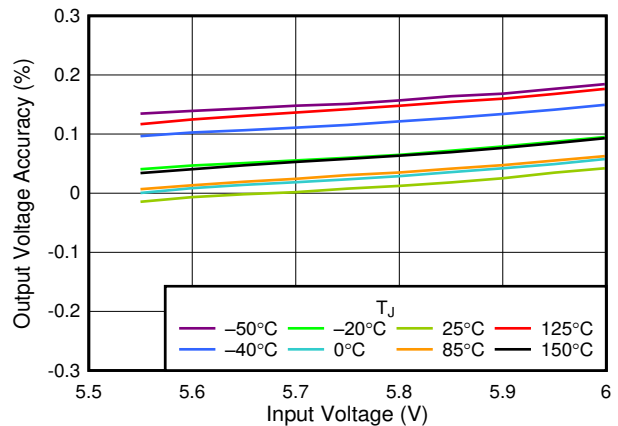

$V_{OUT} = 5.5\text{ V}$ ,  $I_{OUT} = 1\text{ mA}$

Figure 6-8. 5.5-V Line Regulation vs  $V_{IN}$

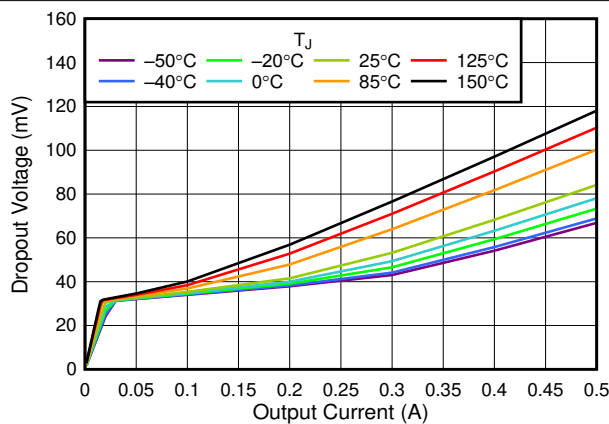

Figure 6-9. 3.3-V Dropout Voltage vs  $I_{OUT}$

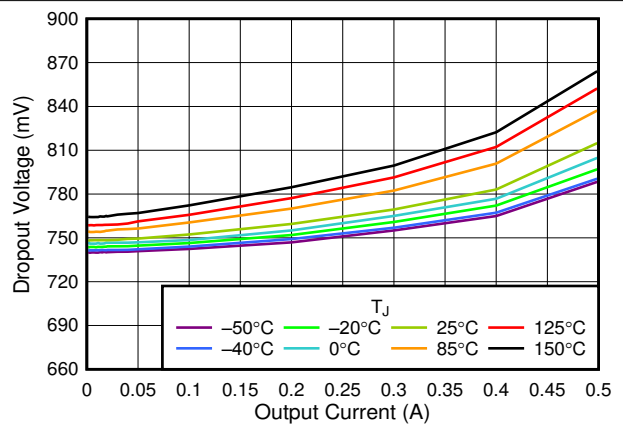

Figure 6-10. 0.55-V Dropout Voltage vs  $I_{OUT}$

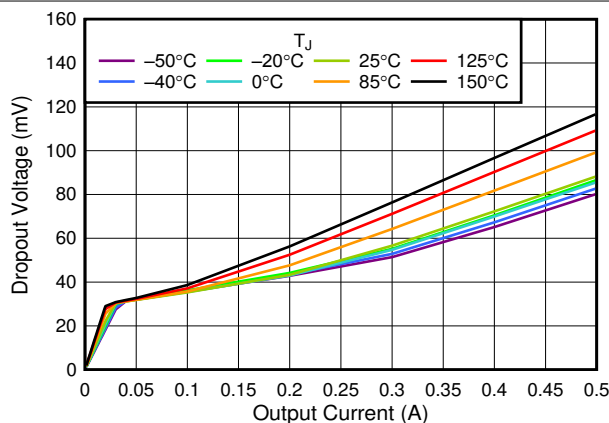

Figure 6-11. 5.5-V Dropout Voltage vs  $I_{OUT}$

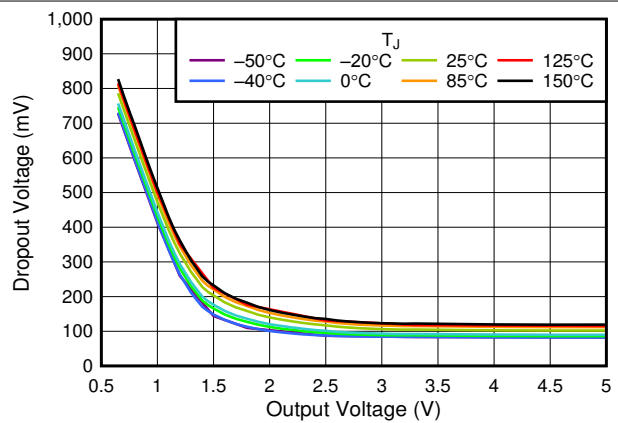

Figure 6-12.  $V_{DO}$  vs  $V_{OUT}$



### 6.7 Typical Characteristics (continued)

at operating temperature range  $T_J = 25^\circ\text{C}$ ,  $V_{IN} = V_{OUT(NOM)} + 0.5\text{ V}$  or  $1.5\text{ V}$  (whichever is greater),  $I_{OUT} = 1\text{ mA}$ ,  $V_{EN} = V_{IN}$ , and  $C_{IN} = C_{OUT} = 1\text{ }\mu\text{F}$  (unless otherwise noted)

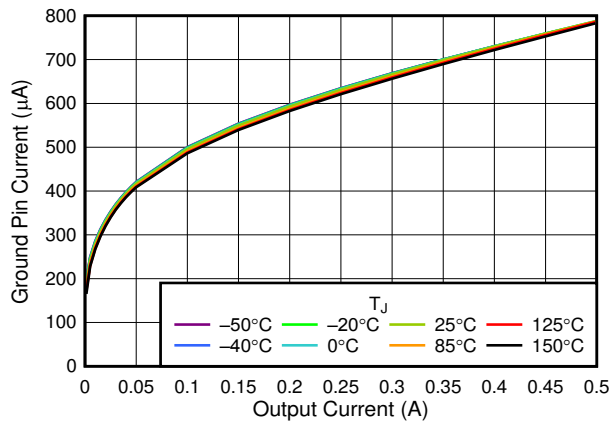

Figure 6-13.  $I_{GND}$  vs  $I_{OUT}$

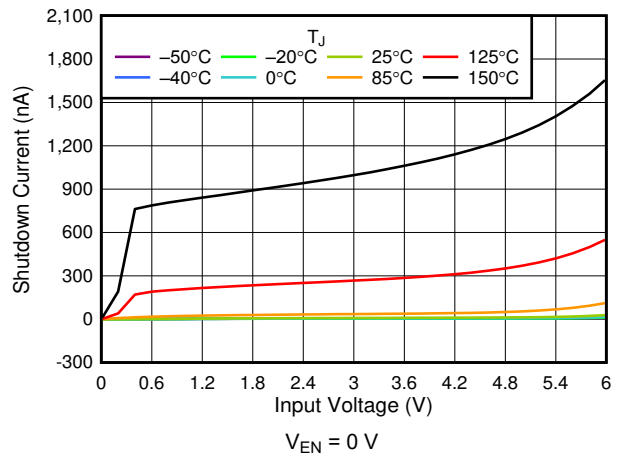
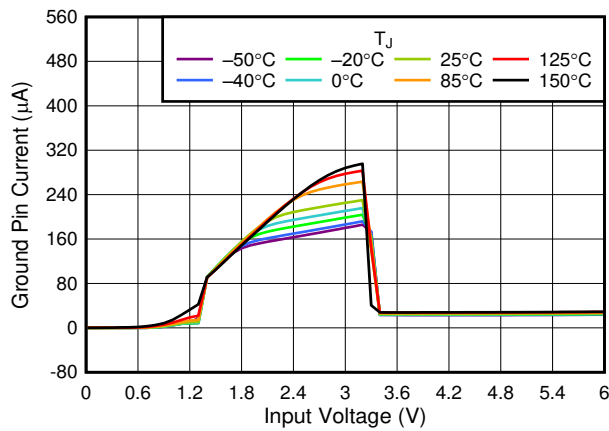
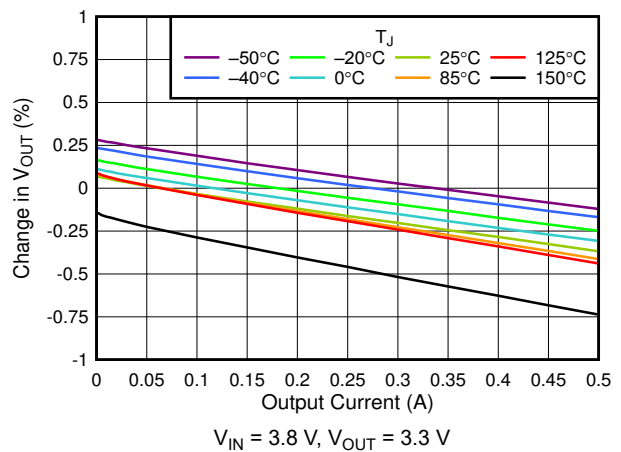

Figure 6-14.  $I_{SHDN}$  vs  $V_{IN}$



$V_{OUT} = 3.3\text{ V}$ ,  $I_{OUT} = 0\text{ mA}$

Figure 6-15.  $I_Q$  vs  $V_{IN}$



$V_{IN} = 3.8\text{ V}$ ,  $V_{OUT} = 3.3\text{ V}$

Figure 6-16. 3.3-V Load Regulation vs  $I_{OUT}$

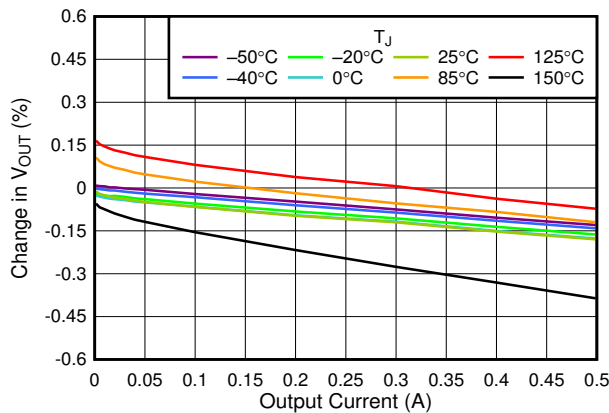

$V_{IN} = 2\text{ V}$ ,  $V_{OUT} = 0.55\text{ V}$

Figure 6-17. 0.55-V Load Regulation vs  $I_{OUT}$

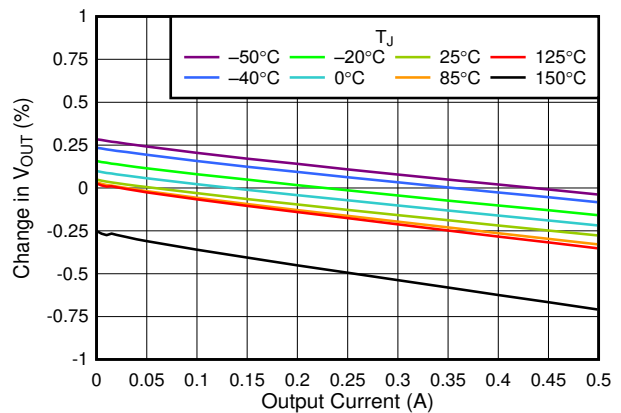

$V_{IN} = 6\text{ V}$ ,  $V_{OUT} = 5.5\text{ V}$

Figure 6-18. 5.5-V Load Regulation vs  $I_{OUT}$

### 6.7 Typical Characteristics (continued)

at operating temperature range  $T_J = 25^\circ\text{C}$ ,  $V_{IN} = V_{OUT(NOM)} + 0.5\text{ V}$  or  $1.5\text{ V}$  (whichever is greater),  $I_{OUT} = 1\text{ mA}$ ,  $V_{EN} = V_{IN}$ , and  $C_{IN} = C_{OUT} = 1\text{ }\mu\text{F}$  (unless otherwise noted)

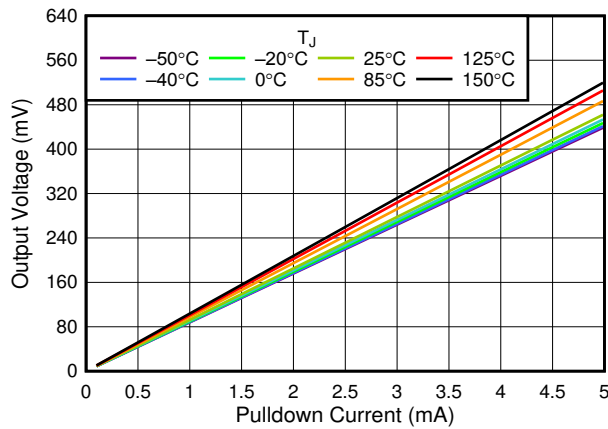

Figure 6-19.  $V_{OUT}$  vs  $I_{OUT}$  Pulldown Resistor

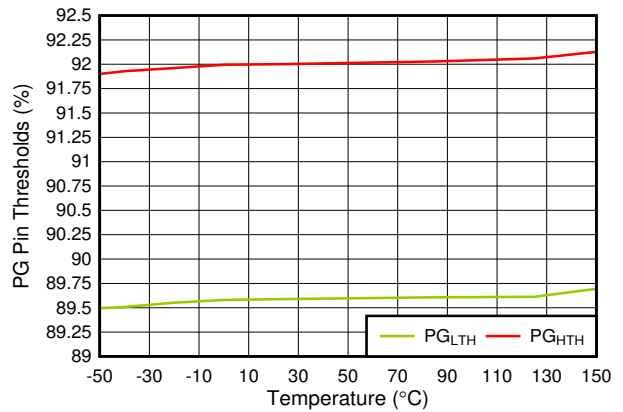

Figure 6-20.  $P_{GLTH}$  and  $P_{GHTH}$  vs Temperature

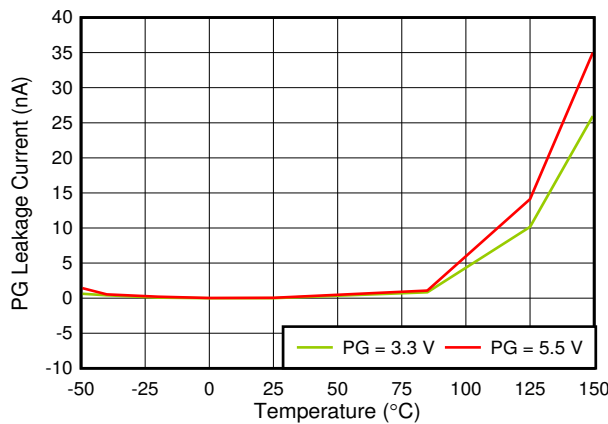

Figure 6-21.  $I_{kg(PG)}$  vs Temperature and PG Pin Voltage

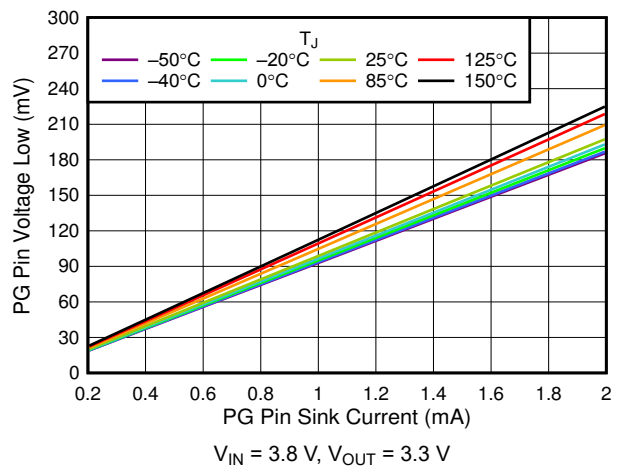

Figure 6-22.  $V_{OL(PG)}$  vs PG Pin Sink Current

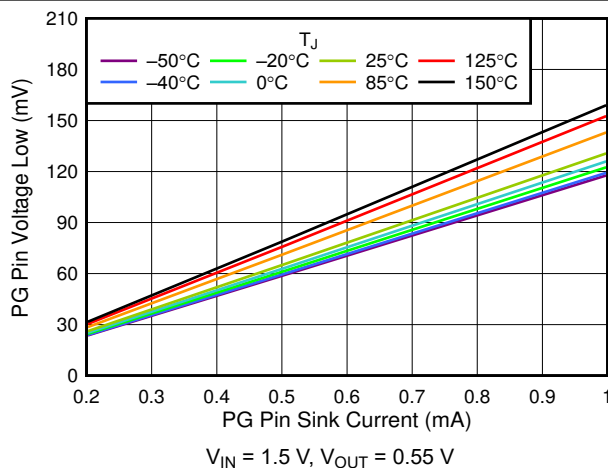

Figure 6-23.  $V_{OL(PG)}$  vs PG Pin Sink Current

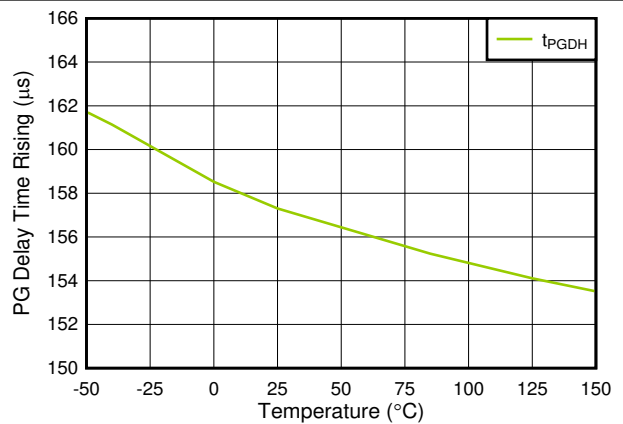

Figure 6-24.  $t_{PGDH}$  vs Temperature

## 6.7 Typical Characteristics (continued)

at operating temperature range  $T_J = 25^\circ\text{C}$ ,  $V_{IN} = V_{OUT(NOM)} + 0.5\text{ V}$  or  $1.5\text{ V}$  (whichever is greater),  $I_{OUT} = 1\text{ mA}$ ,  $V_{EN} = V_{IN}$ , and  $C_{IN} = C_{OUT} = 1\text{ }\mu\text{F}$  (unless otherwise noted)

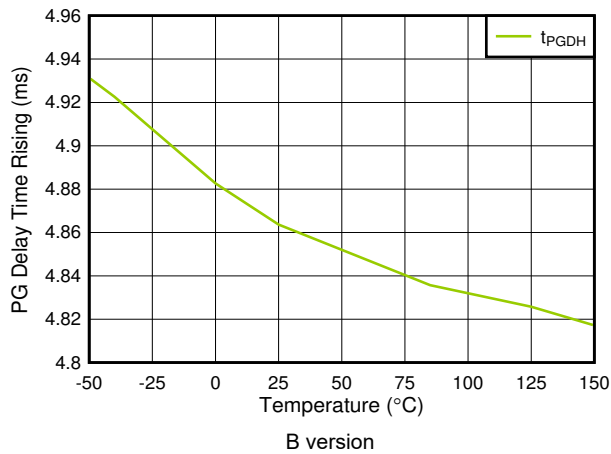

Figure 6-25.  $t_{PGDH}$  vs Temperature (For TPS746B Only)

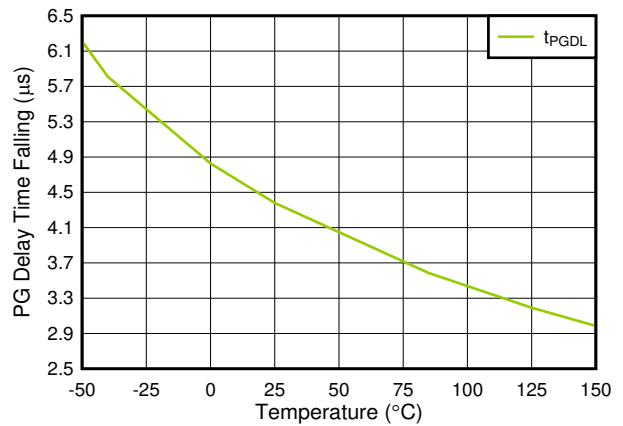

Figure 6-26.  $t_{PGDL}$  vs Temperature

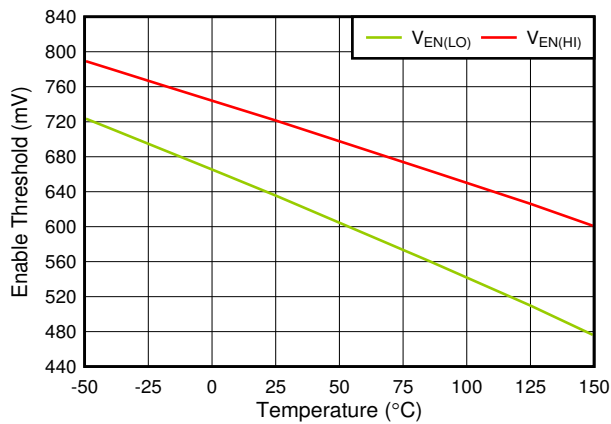

Figure 6-27.  $V_{EN(HI)}$  and  $V_{EN(LO)}$  vs Temperature

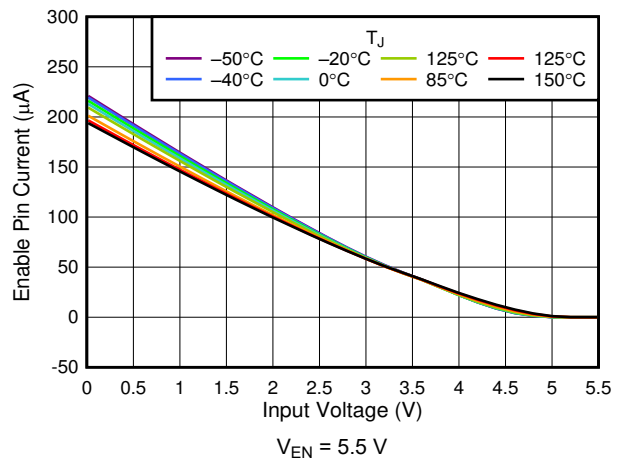

Figure 6-28.  $I_{EN}$  vs  $V_{IN}$

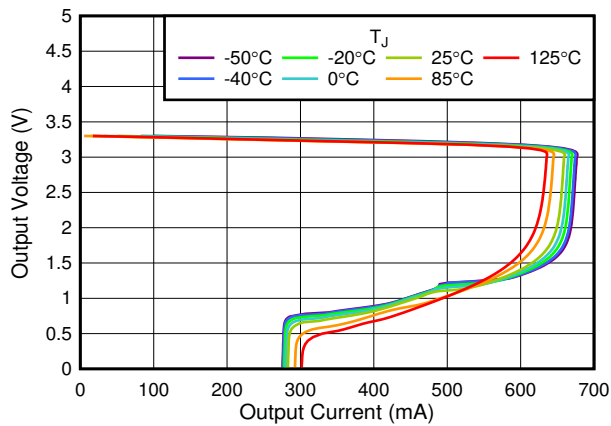

Figure 6-29. 3.3-V  $V_{OUT}$  vs  $I_{OUT}$

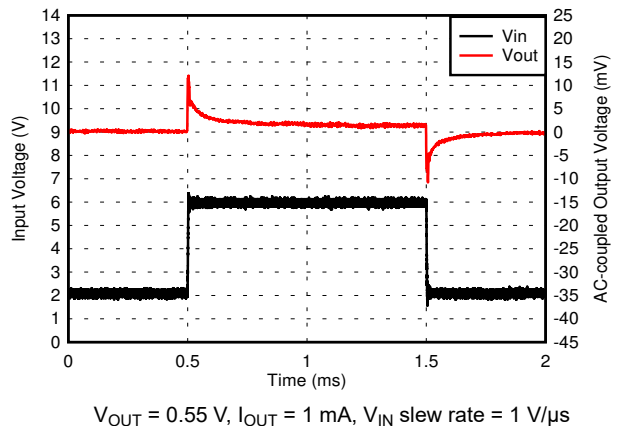
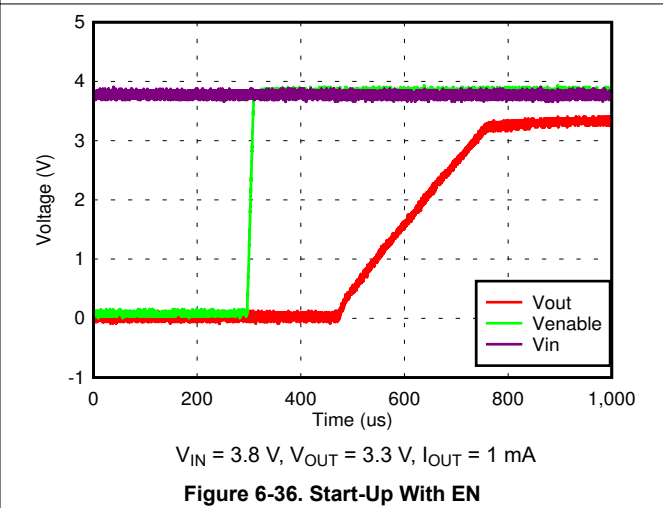
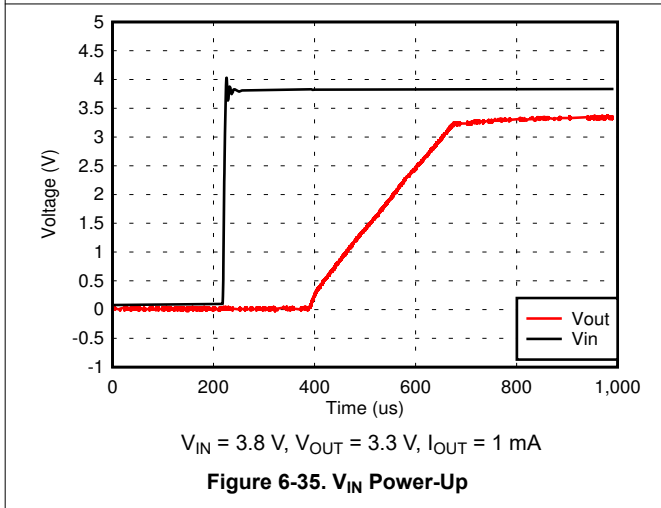
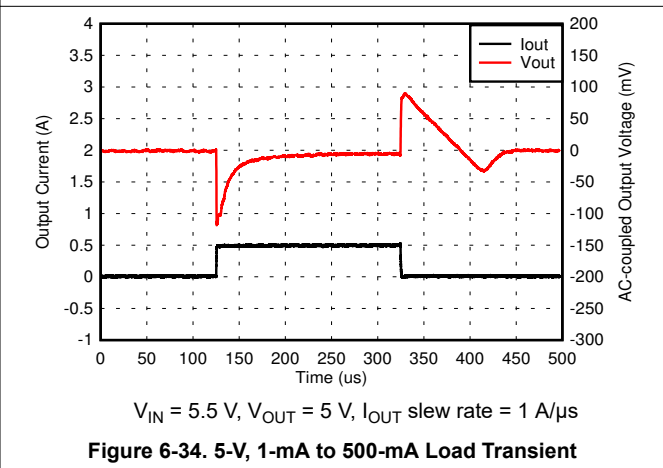
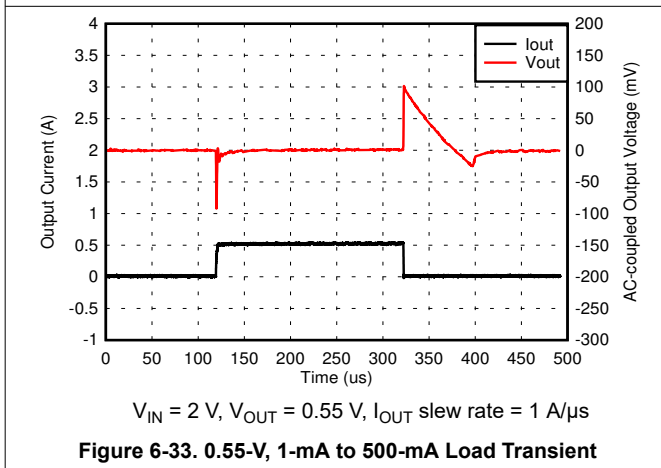
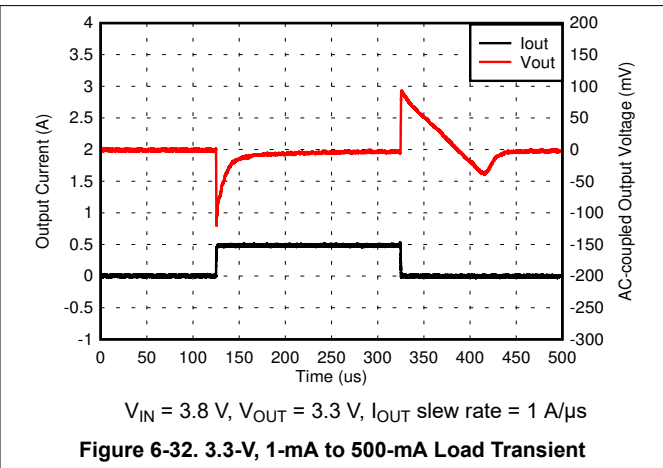
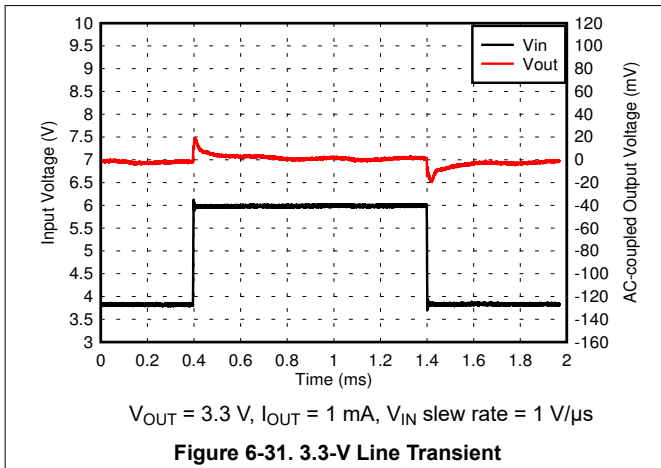

Figure 6-30. 0.55-V Line Transient

### 6.7 Typical Characteristics (continued)

at operating temperature range  $T_J = 25^\circ\text{C}$ ,  $V_{IN} = V_{OUT(NOM)} + 0.5\text{ V}$  or  $1.5\text{ V}$  (whichever is greater),  $I_{OUT} = 1\text{ mA}$ ,  $V_{EN} = V_{IN}$ , and  $C_{IN} = C_{OUT} = 1\text{ }\mu\text{F}$  (unless otherwise noted)



### 6.7 Typical Characteristics (continued)

at operating temperature range  $T_J = 25^\circ\text{C}$ ,  $V_{IN} = V_{OUT(NOM)} + 0.5\text{ V}$  or  $1.5\text{ V}$  (whichever is greater),  $I_{OUT} = 1\text{ mA}$ ,  $V_{EN} = V_{IN}$ , and  $C_{IN} = C_{OUT} = 1\ \mu\text{F}$  (unless otherwise noted)

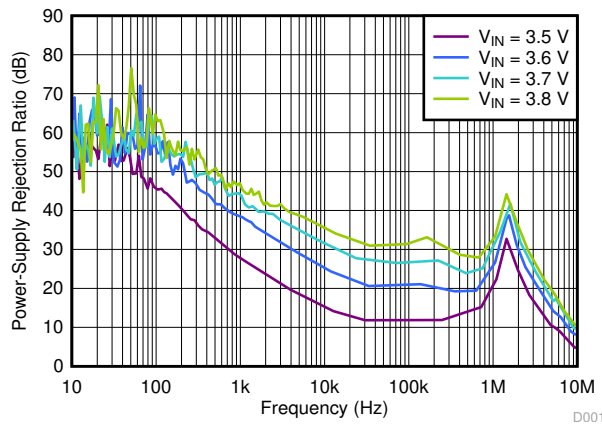

$V_{OUT} = 3.3\text{ V}$ ,  $I_{OUT} = 500\text{ mA}$ ,  $C_{OUT} = 2.2\ \mu\text{F}$

**Figure 6-37. PSRR vs Frequency and  $V_{IN}$**

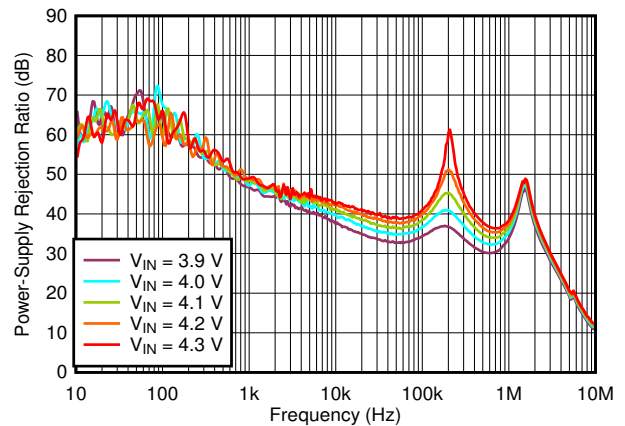

$V_{OUT} = 3.3\text{ V}$ ,  $I_{OUT} = 500\text{ mA}$ ,  $C_{OUT} = 2.2\ \mu\text{F}$

**Figure 6-38. PSRR vs Frequency and  $V_{IN}$**

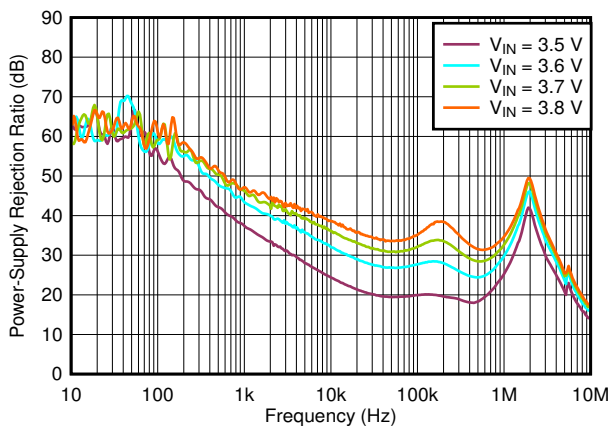

$V_{OUT} = 3.3\text{ V}$ ,  $I_{OUT} = 250\text{ mA}$ ,  $C_{OUT} = 2.2\ \mu\text{F}$

**Figure 6-39. PSRR vs Frequency and  $V_{IN}$**

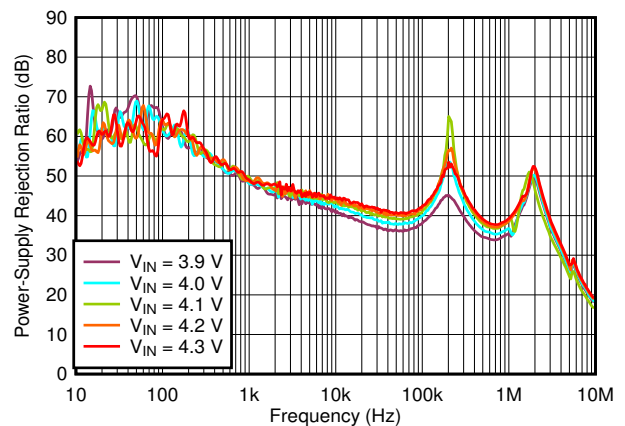

$V_{OUT} = 3.3\text{ V}$ ,  $I_{OUT} = 250\text{ mA}$ ,  $C_{OUT} = 2.2\ \mu\text{F}$

**Figure 6-40. PSRR vs Frequency and  $V_{IN}$**

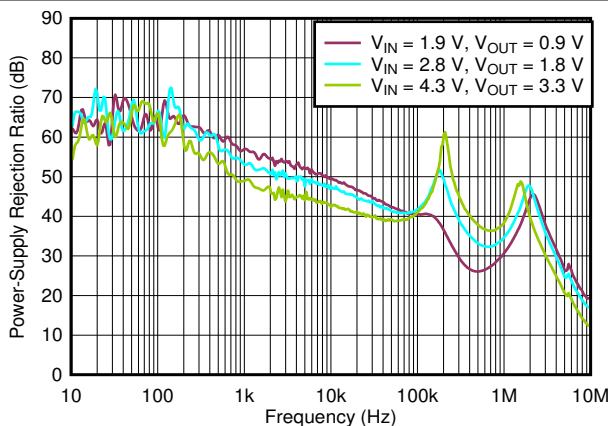

$I_{OUT} = 500\text{ mA}$ ,  $C_{OUT} = 2.2\ \mu\text{F}$

**Figure 6-41. PSRR vs Frequency**

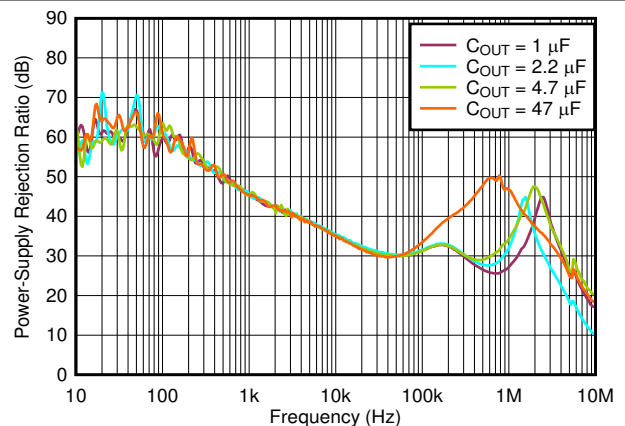

$V_{IN} = 3.8\text{ V}$ ,  $V_{OUT} = 3.3\text{ V}$ ,  $I_{OUT} = 500\text{ mA}$

**Figure 6-42. PSRR vs Frequency and  $C_{OUT}$**

### 6.7 Typical Characteristics (continued)

at operating temperature range  $T_J = 25^\circ\text{C}$ ,  $V_{IN} = V_{OUT(NOM)} + 0.5\text{ V}$  or  $1.5\text{ V}$  (whichever is greater),  $I_{OUT} = 1\text{ mA}$ ,  $V_{EN} = V_{IN}$ , and  $C_{IN} = C_{OUT} = 1\ \mu\text{F}$  (unless otherwise noted)

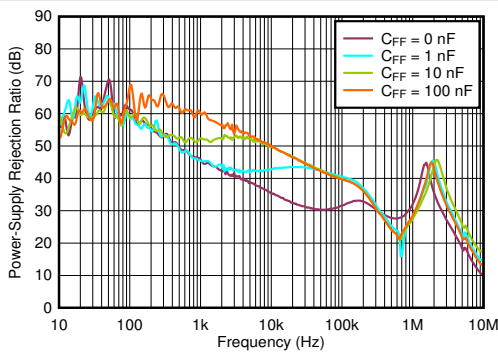

$V_{IN} = 3.8\text{ V}$ ,  $V_{OUT} = 3.3\text{ V}$ ,  $I_{OUT} = 500\text{ mA}$

**Figure 6-43. PSRR vs Frequency and  $C_{FF}$**

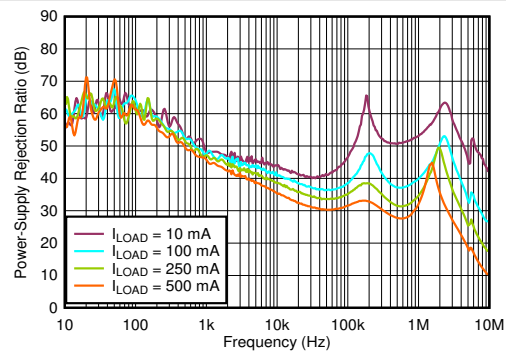

$V_{IN} = 3.8\text{ V}$ ,  $V_{OUT} = 3.3\text{ V}$ ,  $C_{OUT} = 2.2\ \mu\text{F}$

**Figure 6-44. PSRR vs Frequency and  $I_{LOAD}$**

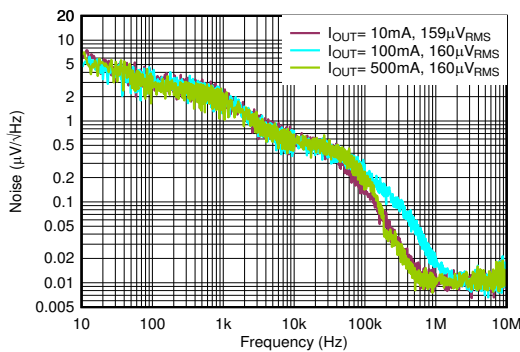

$V_{IN} = 3.8\text{ V}$ ,  $V_{OUT} = 3.3\text{ V}$ ,  $C_{OUT} = 2.2\ \mu\text{F}$ ,  $V_{RMS}$  BW = 10 Hz to 100 kHz

**Figure 6-45. Output Spectral Noise Density vs Frequency and  $I_{OUT}$**

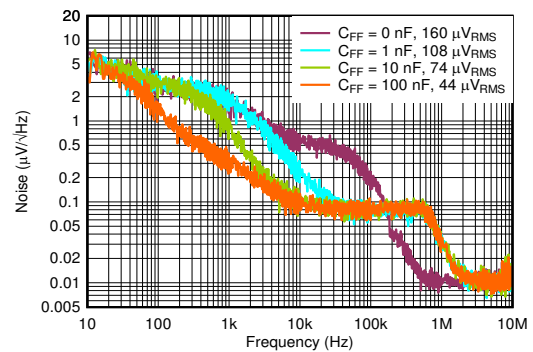

$V_{IN} = 3.8\text{ V}$ ,  $V_{OUT} = 3.3\text{ V}$ ,  $I_{OUT} = 500\text{ mA}$ ,  $C_{OUT} = 2.2\ \mu\text{F}$ ,  $V_{RMS}$  BW = 10 Hz to 100 kHz

**Figure 6-46. Output Spectral Noise Density vs Frequency and  $C_{FF}$**

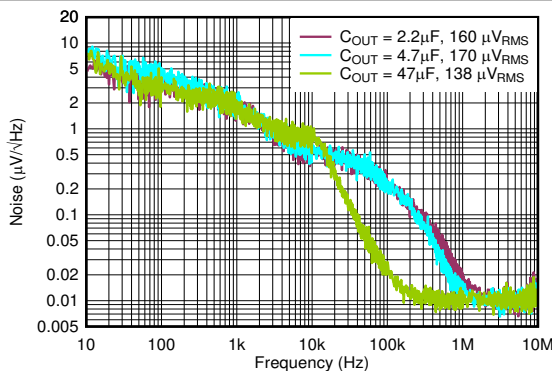

$V_{IN} = 3.8\text{ V}$ ,  $V_{OUT} = 3.3\text{ V}$ ,  $I_{OUT} = 100\text{ mA}$ ,  $C_{FF} = 0\ \mu\text{F}$ ,  $V_{RMS}$  BW = 10 Hz to 100 kHz

**Figure 6-47. Output Spectral Noise Density vs Frequency and  $C_{OUT}$**

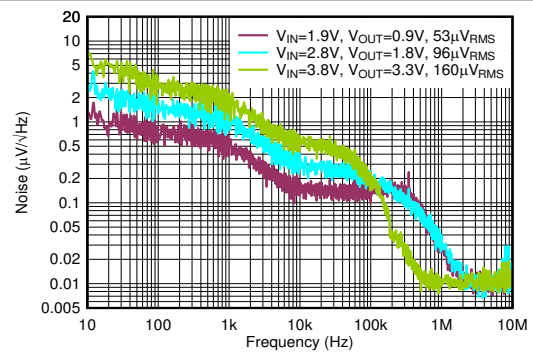

$I_{OUT} = 500\text{ mA}$ ,  $C_{OUT} = 2.2\ \mu\text{F}$ ,  $V_{RMS}$  BW = 10 Hz to 100 kHz

**Figure 6-48. Output Spectral Noise Density vs Frequency**

## 7 Detailed Description

### 7.1 Overview

The TPS745-Q1 is a low-dropout regulator (LDO) that consumes low quiescent current and delivers excellent line and load transient performance. These characteristics, combined with low noise, good PSRR with low dropout voltage, make this device ideal for automotive applications.

This regulator offers foldback current limit, shutdown, and thermal protection. The operating junction temperature for this device is  $-40^{\circ}\text{C}$  to  $+150^{\circ}\text{C}$ .

### 7.2 Functional Block Diagrams

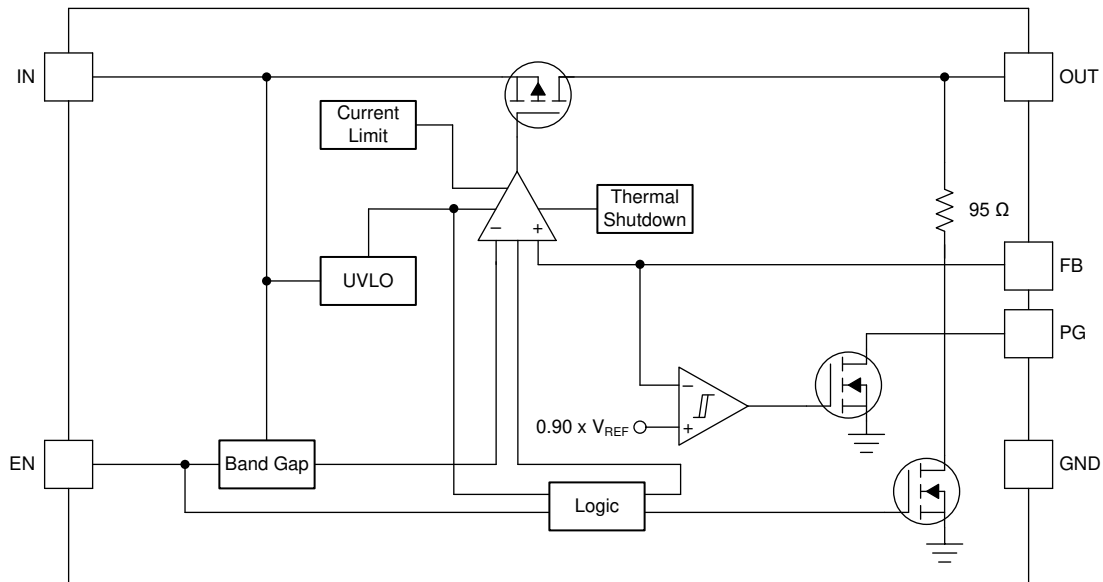

**Figure 7-1. Adjustable Version With Open-Drain Power-Good**

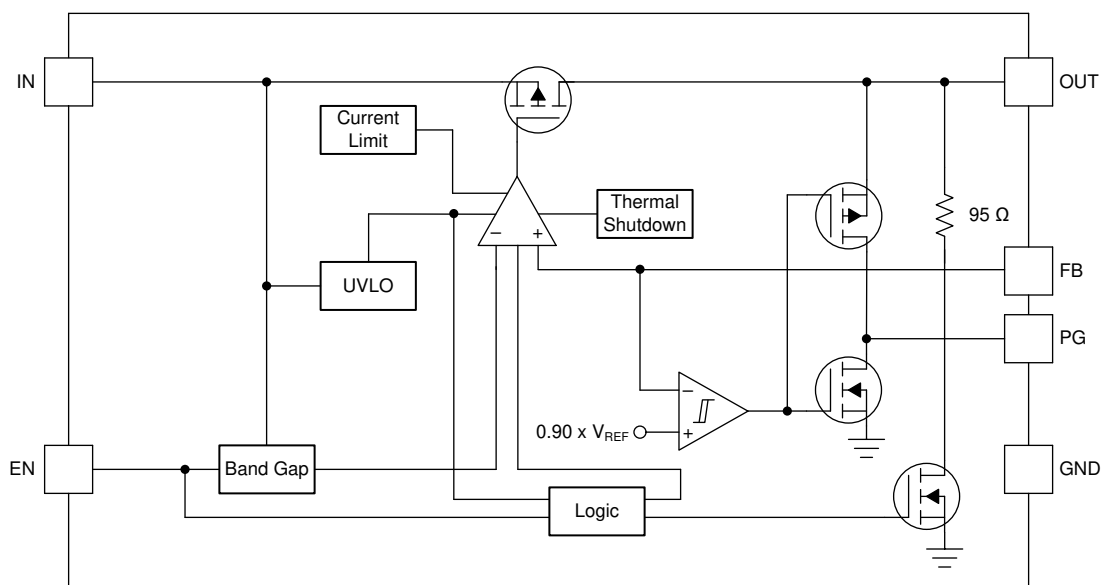

**Figure 7-2. Adjustable Version With Push-Pull Power-Good**

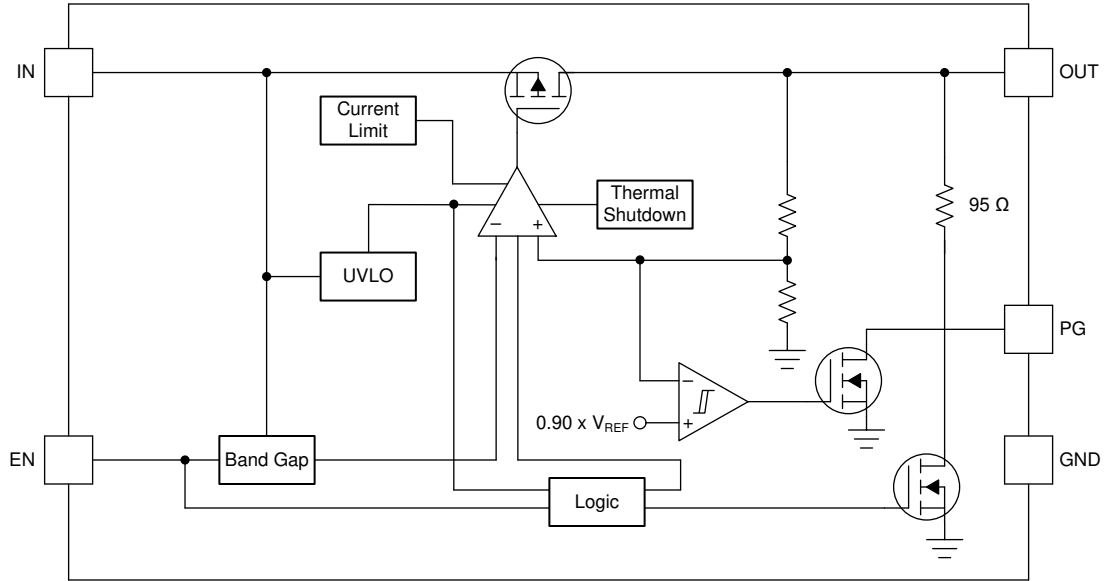

**Figure 7-3. Fixed Voltage Version With Open-Drain Power-Good**

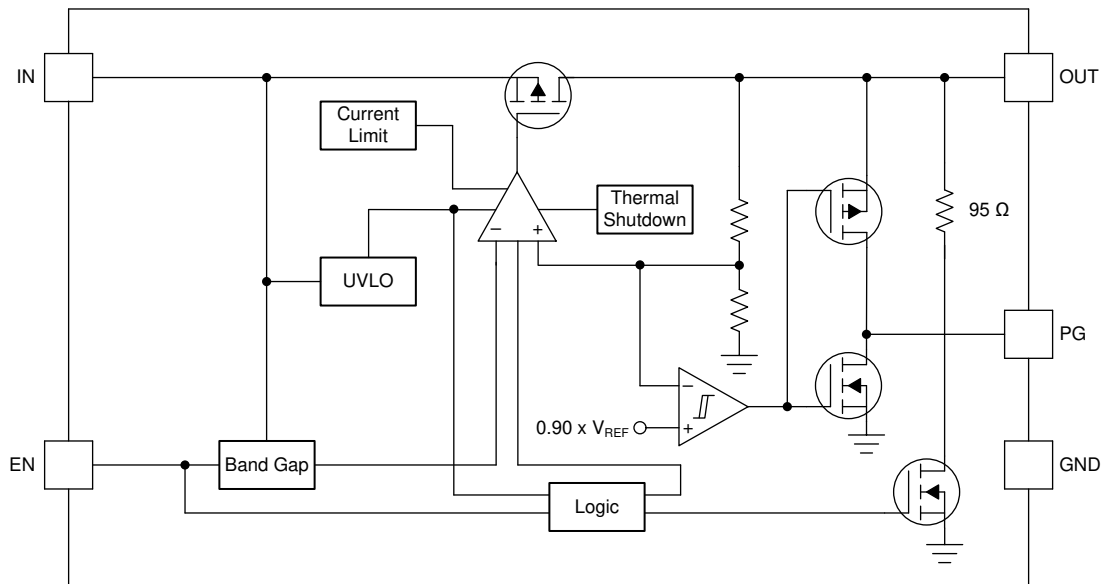

**Figure 7-4. Fixed Voltage Version With Push-Pull Power-Good**



## 7.3 Feature Description

### 7.3.1 TPS745-Q1 Comparison

Table 7-1 lists the three different power-good (PG) options for the TPS745-Q1.

**Table 7-1. TPS745-Q1 Comparison Table**

DEVICE	POWER-GOOD DELAY	POWER-GOOD TYPE
TPS745xxPQWDRVRQ1, TPS745xxPQWDRBRQ1	150 $\mu$ s	Open-drain
TPS745xxPBQWDRVRQ1	5 ms	Open-drain
TPS745xxPCQWDRVRQ1	150 $\mu$ s	Push-pull

### 7.3.2 Undervoltage Lockout (UVLO)

The TPS745-Q1 uses an undervoltage lockout (UVLO) circuit that disables the output until the input voltage is greater than the rising UVLO voltage ( $V_{UVLO}$ ). This circuit ensures that the device does not exhibit any unpredictable behavior when the supply voltage is lower than the operational range of the internal circuitry. When  $V_{IN}$  is less than  $V_{UVLO}$ , the output is connected to ground with a pulldown resistor ( $R_{PULLDOWN}$ ). When the device enters UVLO, the PG output is pulled low.

### 7.3.3 Shutdown

The enable pin (EN) is active high. Enable the device by forcing the EN pin to exceed  $V_{EN(HI)}$ . Turn off the device by forcing the EN pin to drop below  $V_{EN(LO)}$ . If shutdown capability is not required, connect EN to IN. When the device is disabled, the PG output pin is pulled low.

The TPS745-Q1 has an internal pulldown MOSFET that connects an  $R_{PULLDOWN}$  resistor to ground when the device is disabled. The discharge time after disabling depends on the output capacitance ( $C_{OUT}$ ) and the load resistance ( $R_L$ ) in parallel with the pulldown resistor ( $R_{PULLDOWN}$ ). Equation 1 calculates the time constant:

$$\tau = (R_{PULLDOWN} \times R_L) / (R_{PULLDOWN} + R_L) \times C_{OUT} \quad (1)$$

### 7.3.4 Foldback Current Limit

The device has an internal current limit circuit that protects the regulator during transient high-load current faults or shorting events. The current limit is a hybrid brick-wall-foldback scheme. The current limit transitions from a brick-wall scheme to a foldback scheme at the foldback voltage ( $V_{FOLDBACK}$ ). In a high-load current fault with the output voltage above  $V_{FOLDBACK}$ , the brick-wall scheme limits the output current to the current limit ( $I_{CL}$ ). When the voltage drops below  $V_{FOLDBACK}$ , a foldback current limit activates that scales back the current as the output voltage approaches GND. When the output is shorted, the device supplies a typical current called the short-circuit current limit ( $I_{SC}$ ).  $I_{CL}$  and  $I_{SC}$  are listed in the *Electrical Characteristics* table.

For this device,  $V_{FOLDBACK} = 0.4 \times V_{OUT(NOM)}$ .

The output voltage is not regulated when the device is in current limit. When a current limit event occurs, the device begins to heat up because of the increase in power dissipation. When the device is in brickwall current limit, the pass transistor dissipates power  $[(V_{IN} - V_{OUT}) \times I_{CL}]$ . When the device output is shorted and the output is below  $V_{FOLDBACK}$ , the pass transistor dissipates power  $[(V_{IN} - V_{OUT}) \times I_{SC}]$ . If thermal shutdown is triggered, the device turns off. After the device cools down, the internal thermal shutdown circuit turns the device back on. If the output current fault condition continues, the device cycles between current limit and thermal shutdown. For more information on current limits, see the [Know Your Limits application report](#).

Figure 7-5 shows a diagram of the foldback current limit.

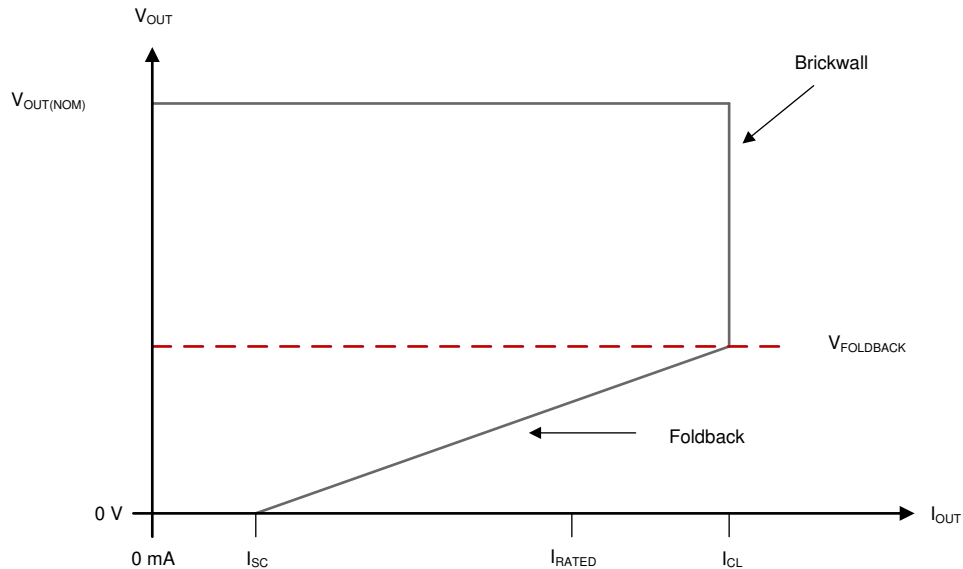

**Figure 7-5. Foldback Current Limit**

### 7.3.5 Thermal Shutdown

Thermal shutdown protection disables the output when the junction temperature rises to approximately 170°C. Disabling the device eliminates the power dissipated by the device, allowing the device to cool. When the junction temperature cools to approximately 155°C, the output circuitry is again enabled. Depending on power dissipation, thermal resistance, and ambient temperature, the thermal protection circuit may cycle on and off. This cycling limits regulator dissipation, protecting the regulator from damage as a result of overheating.

Activating the thermal shutdown feature usually indicates excessive power dissipation as a result of the product of the  $(V_{IN} - V_{OUT})$  voltage and the load current. For reliable operation, limit junction temperature to 150°C maximum. To estimate the margin of safety in a complete design, increase the ambient temperature until the thermal protection is triggered; use worst-case loads and signal conditions.

The TPS745-Q1 internal protection circuitry protects against overload conditions but is not intended to be activated in normal operation. Continuously running the TPS745-Q1 into thermal shutdown degrades device reliability.

## 7.4 Device Functional Modes

### 7.4.1 Device Functional Mode Comparison

The *Device Functional Mode Comparison* table shows the conditions that lead to the different modes of operation. See the *Electrical Characteristics* table for parameter values.

**Table 7-2. Device Functional Mode Comparison**

OPERATING MODE	PARAMETER			
	$V_{IN}$	$V_{EN}$	$I_{OUT}$	$T_J$
Normal operation	$V_{IN} > V_{OUT(nom)} + V_{DO}$ and $V_{IN} > V_{IN(min)}$	$V_{EN} > V_{EN(HI)}$	$I_{OUT} < I_{OUT(max)}$	$T_J < T_{SD(shutdown)}$
Dropout operation	$V_{IN(min)} < V_{IN} < V_{OUT(nom)} + V_{DO}$	$V_{EN} > V_{EN(HI)}$	$I_{OUT} < I_{OUT(max)}$	$T_J < T_{SD(shutdown)}$
Disabled (any true condition disables the device)	$V_{IN} < V_{UVLO}$	$V_{EN} < V_{EN(LOW)}$	Not applicable	$T_J > T_{SD(shutdown)}$

### 7.4.2 Normal Operation

The device regulates to the nominal output voltage when the following conditions are met:

- The input voltage is greater than the nominal output voltage plus the dropout voltage ( $V_{OUT(nom)} + V_{DO}$ )
- The output current is less than the current limit ( $I_{OUT} < I_{CL}$ )
- The device junction temperature is less than the thermal shutdown temperature ( $T_J < T_{SD}$ )
- The enable voltage has previously exceeded the enable rising threshold voltage and has not yet decreased to less than the enable falling threshold

### 7.4.3 Dropout Operation

If the input voltage is lower than the nominal output voltage plus the specified dropout voltage, but all other conditions are met for normal operation, the device operates in dropout mode. In this mode, the output voltage tracks the input voltage. During this mode, the transient performance of the device becomes significantly degraded because the pass transistor is in the ohmic or triode region, and acts as a switch. Line or load transients in dropout can result in large output-voltage deviations.

When the device is in a steady dropout state (defined as when the device is in dropout,  $V_{IN} < V_{OUT(NOM)} + V_{DO}$ , directly after being in a normal regulation state, but *not* during startup), the pass transistor is driven into the ohmic or triode region. When the input voltage returns to a value greater than or equal to the nominal output voltage plus the dropout voltage ( $V_{OUT(NOM)} + V_{DO}$ ), the output voltage can overshoot for a short period of time while the device pulls the pass transistor back into the linear region.

### 7.4.4 Disabled

The output of the device can be shutdown by forcing the voltage of the enable pin to less than the maximum EN pin low-level input voltage (see the *Electrical Characteristics* table). When disabled, the pass transistor is turned off, internal circuits are shutdown, and the output voltage is actively discharged to ground by an internal discharge circuit from the output to ground.

## 8 Application and Implementation

### Note

Information in the following applications sections is not part of the TI component specification, and TI does not warrant its accuracy or completeness. TI's customers are responsible for determining suitability of components for their purposes, as well as validating and testing their design implementation to confirm system functionality.

### 8.1 Application Information

#### 8.1.1 Adjustable Device Feedback Resistors

Figure 8-1 shows that the output voltage of the TPS745P-Q1 can be adjusted from 0.55 V to 5.5 V by using a resistor divider network.

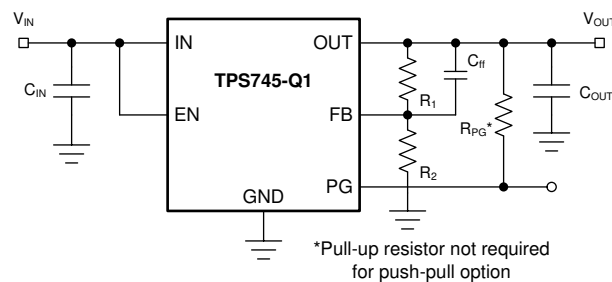

**Figure 8-1. Adjustable Operation**

The adjustable-version device requires external feedback divider resistors to set the output voltage.  $V_{OUT}$  is set using the feedback divider resistors,  $R_1$  and  $R_2$ , according to the following equation:

$$V_{OUT} = V_{FB} \times (1 + R_1 / R_2) \quad (2)$$

To ignore the FB pin current error term in the  $V_{OUT}$  equation, set the feedback divider current to 100x the FB pin current listed in the *Electrical Characteristics* table. This setting provides the maximum feedback divider series resistance, as shown in the following equation:

$$R_1 + R_2 \leq V_{OUT} / (I_{FB} \times 100) \quad (3)$$

#### 8.1.2 Input and Output Capacitor Selection

The TPS745-Q1 requires an output capacitance of 0.47  $\mu\text{F}$  or larger for stability. Use X5R- and X7R-type ceramic capacitors because these capacitors have minimal variation in value and equivalent series resistance (ESR) over temperature. When choosing a capacitor for a specific application be mindful of the DC bias characteristics for the capacitor. Higher output voltages cause a significant derating of the capacitor. For best performance, the maximum recommended output capacitance is 220  $\mu\text{F}$ .

Although an input capacitor is not required for stability, good analog design practice is to connect a capacitor from IN to GND. Some input supplies have a high impedance, thus placing the input capacitor on the input supply helps reduce the input impedance. This capacitor counteracts reactive input sources and improves transient response, input ripple, and PSRR. If the input supply has a high impedance over a large range of frequencies, several input capacitors can be used in parallel to lower the impedance over frequency. Use a higher-value capacitor if large, fast, rise-time load transients are anticipated, or if the device is located several inches from the input power source.

### 8.1.3 Dropout Voltage

The TPS745-Q1 uses a PMOS pass transistor to achieve low dropout. When  $(V_{IN} - V_{OUT})$  is less than the dropout voltage ( $V_{DO}$ ), the PMOS pass device is in the linear region of operation and the input-to-output resistance is the  $R_{DS(ON)}$  of the PMOS pass element.  $V_{DO}$  scales approximately with output current because the PMOS device behaves like a resistor in dropout mode. As with any linear regulator, PSRR and transient response degrade as  $(V_{IN} - V_{OUT})$  approaches dropout operation.

### 8.1.4 Exiting Dropout

Some applications have transients that place the LDO into dropout, such as slower ramps on  $V_{IN}$  during start-up. As with other LDOs, the output can overshoot on recovery from these conditions. A ramping input supply causes an LDO to overshoot on start-up, as shown in [Figure 8-2](#), when the slew rate and voltage levels are in the correct range. Use an enable signal to avoid this condition.

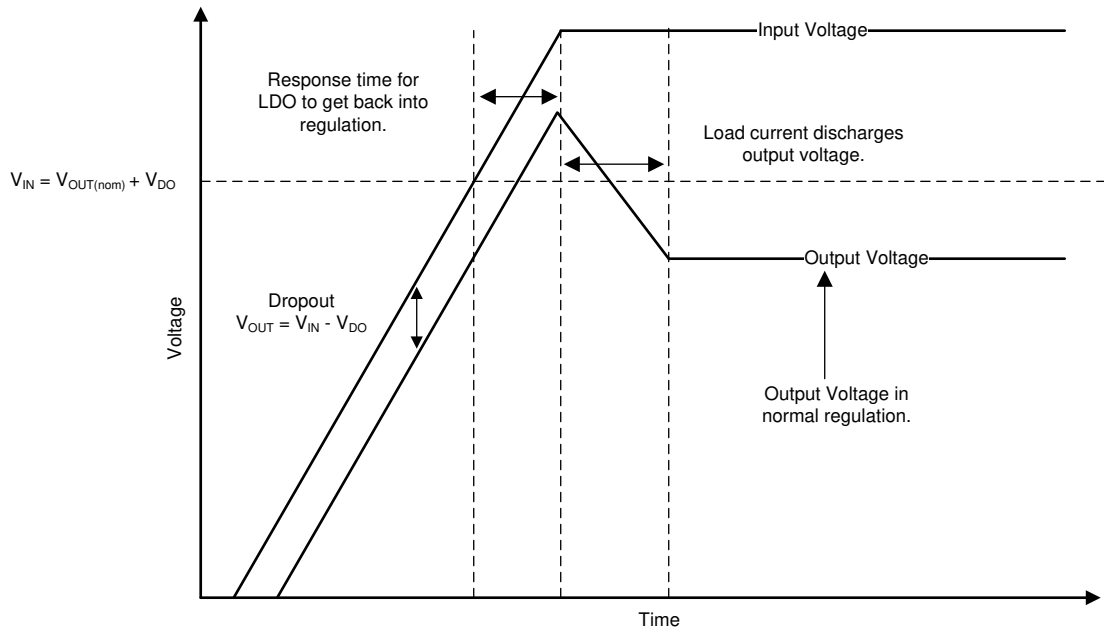

**Figure 8-2. Start-Up Into Dropout**

Line transients out of dropout can also cause overshoot on the output of the regulator. These overshoots are caused by the error amplifier having to drive the gate capacitance of the pass element and bring the gate back to the correct voltage for proper regulation. [Figure 8-3](#) illustrates what is happening internally with the gate voltage and how overshoot can be caused during operation. When the LDO is placed in dropout, the gate voltage ( $V_{GS}$ ) is pulled all the way down to ground to give the pass device the lowest on-resistance as possible. However, if a line transient occurs when the device is in dropout, the loop is not in regulation and can cause the output to overshoot until the loop responds and the output current pulls the output voltage back down into regulation. If these transients are not acceptable, then continue to add input capacitance in the system until the transient is slow enough to reduce the overshoot.

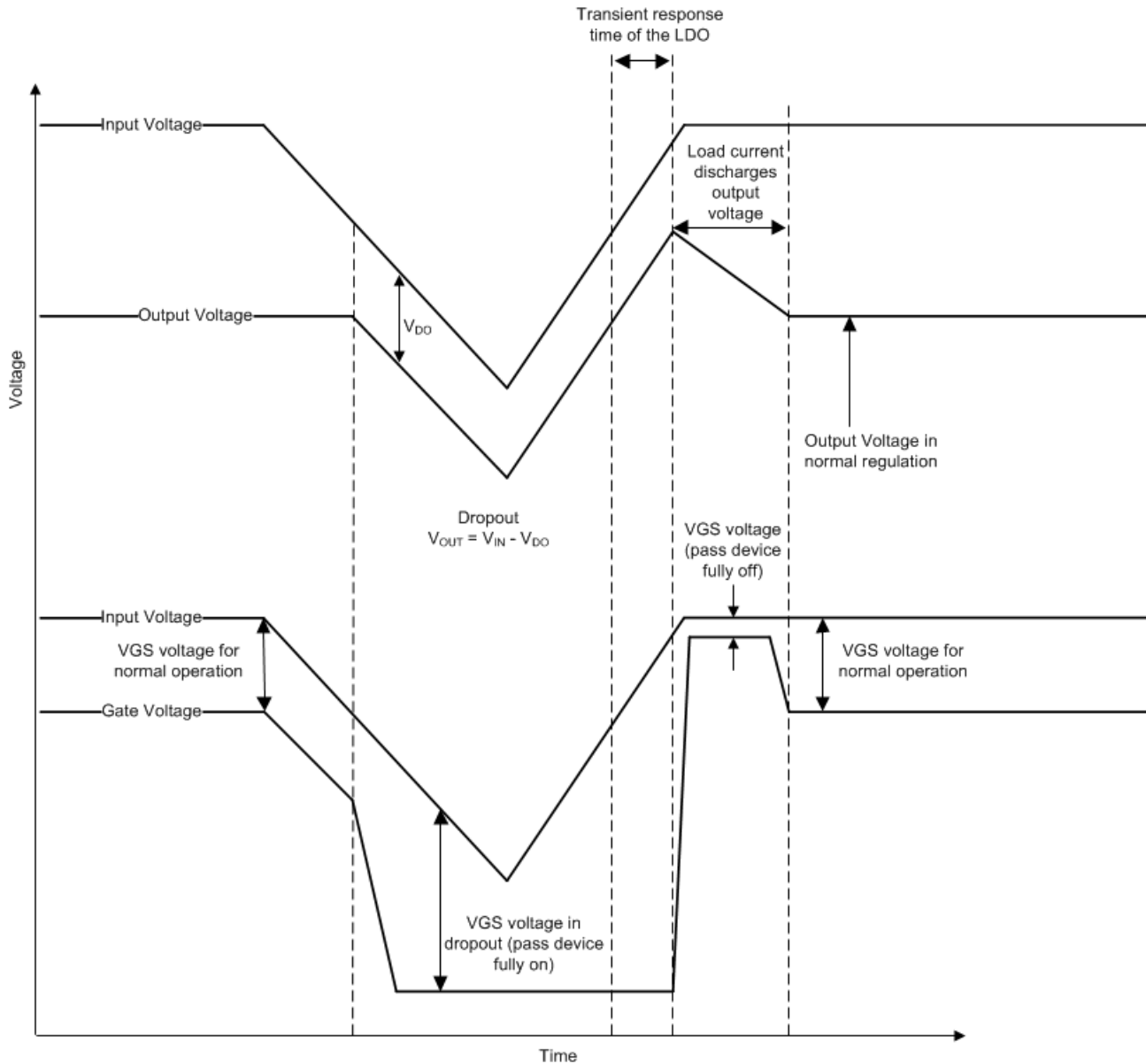

**Figure 8-3. Line Transients From Dropout**

### 8.1.5 Reverse Current

As with most LDOs, excessive reverse current can damage this device.

Reverse current flows through the body diode on the pass element instead of the normal conducting channel. At high magnitudes, this current flow degrades the long-term reliability of the device, as a result of one of the following conditions:

- Degradation caused by electromigration
- Excessive heat dissipation
- Potential for a latch-up condition

Conditions where reverse current can occur are outlined in this section, all of which can exceed the absolute maximum rating of  $V_{OUT} > V_{IN} + 0.3\text{ V}$ :

- If the device has a large  $C_{OUT}$  and the input supply collapses with little or no load current
- The output is biased when the input supply is not established
- The output is biased above the input supply

If reverse current flow is expected in the application, external protection must be used to protect the device. [Figure 8-4](#) shows one approach of protecting the device.

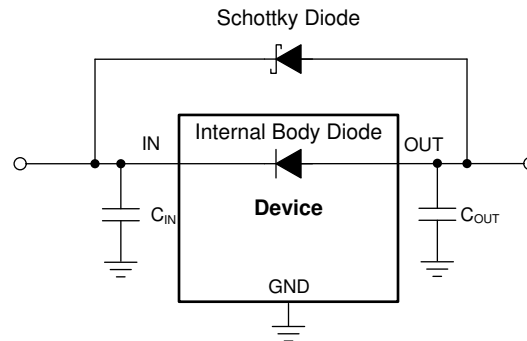

**Figure 8-4. Example Circuit for Reverse Current Protection Using a Schottky Diode**

### 8.1.6 Power Dissipation ( $P_D$ )

Circuit reliability requires consideration of the device power dissipation, location of the circuit on the printed circuit board (PCB), and correct sizing of the thermal plane. The PCB area around the regulator must have few or no other heat-generating devices that cause added thermal stress.

To first-order approximation, power dissipation in the regulator depends on the input-to-output voltage difference and load conditions. The following equation calculates power dissipation ( $P_D$ ).

$$P_D = (V_{IN} - V_{OUT}) \times I_{OUT} \quad (4)$$

#### Note

Power dissipation can be minimized, and therefore greater efficiency can be achieved, by correct selection of the system voltage rails. For the lowest power dissipation use the minimum input voltage required for correct output regulation.

For devices with a thermal pad, the primary heat conduction path for the device package is through the thermal pad to the PCB. Solder the thermal pad to a copper pad area under the device. This pad area must contain an array of plated vias that conduct heat to additional copper planes for increased heat dissipation.

The maximum power dissipation determines the maximum allowable ambient temperature ( $T_A$ ) for the device. According to the following equation, power dissipation and junction temperature are most often related by the junction-to-ambient thermal resistance ( $R_{\theta JA}$ ) of the combined PCB and device package and the temperature of the ambient air ( $T_A$ ).

$$T_J = T_A + (R_{\theta JA} \times P_D) \quad (5)$$

Thermal resistance ( $R_{\theta JA}$ ) is highly dependent on the heat-spreading capability built into the particular PCB design, and therefore varies according to the total copper area, copper weight, and location of the planes. The junction-to-ambient thermal resistance listed in the *Thermal Information* table is determined by the JEDEC standard PCB and copper-spreading area, and is used as a relative measure of package thermal performance.

[Figure 8-5](#) and [Figure 8-6](#) illustrate the functions of  $R_{\theta JA}$  and  $\psi_{JB}$  versus copper (Cu) area and thickness. These plots are generated with a 101.6-mm x 101.6-mm x 1.6-mm printed circuit board (PCB) of two and four layers. For the four-layer board, the inner planes use a 1-oz copper thickness. Outer layers are simulated with both 1-oz and 2-oz copper thickness. A 2 x 1 array of thermal vias of 300- $\mu$ m drill diameter and 25- $\mu$ m Cu plating is located beneath the thermal pad of the device. The thermal vias connect the top layer, the bottom layer and, in the case of the 4-layer board, the first inner GND plane.

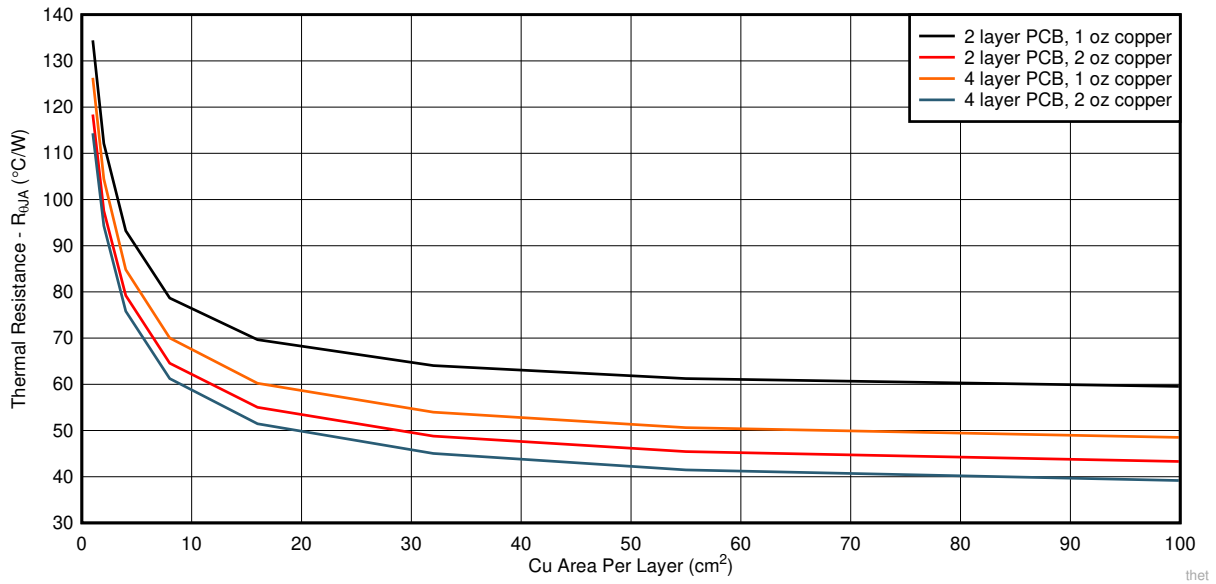

Figure 8-5.  $R_{\theta JA}$  versus Cu Area for the WSON (DRV) Package

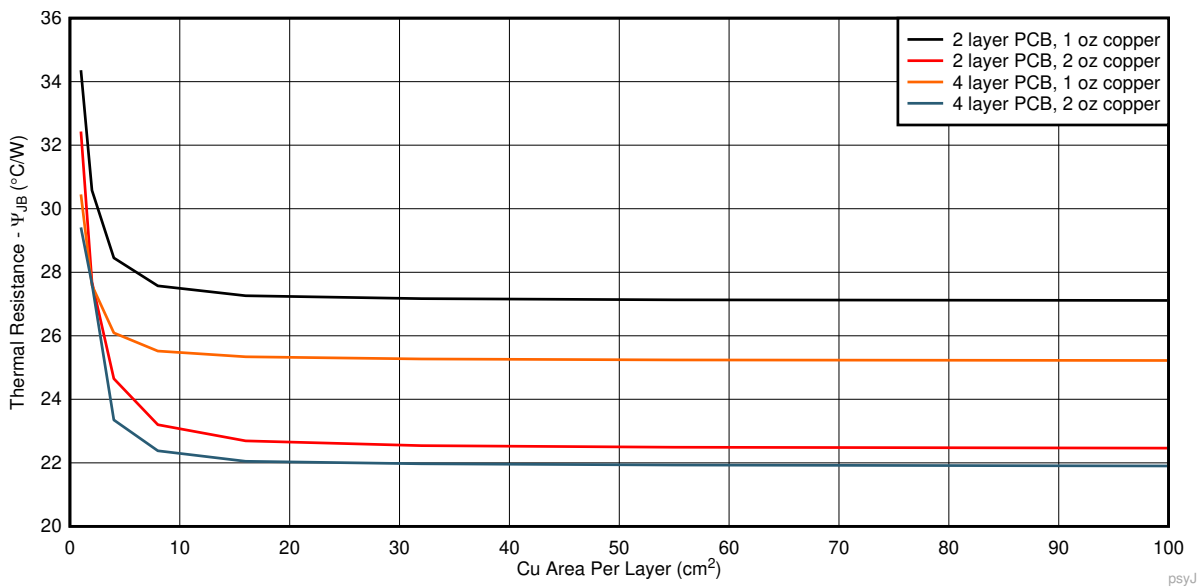
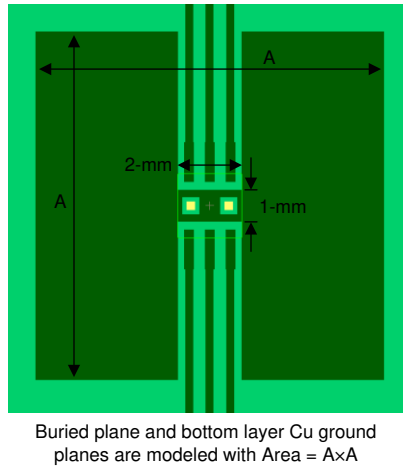

Figure 8-6.  $\psi_{JB}$  versus Cu Area for the WSON (DRV) Package



As shown in [Figure 8-7](#), each layer has a copper plane of equal area.



**Figure 8-7. Board parameters used for simulation**

For a more comprehensive study of how thermal resistance varies with copper area and thickness, see the [An empirical analysis of the impact of board layout on LDO thermal performance application report](#). As shown in [Figure 8-8](#), modifying board layout to be more thermally enhanced can lower the  $R_{\theta JA}$  value from 80.3°C/W to 46.8°C/W or better.

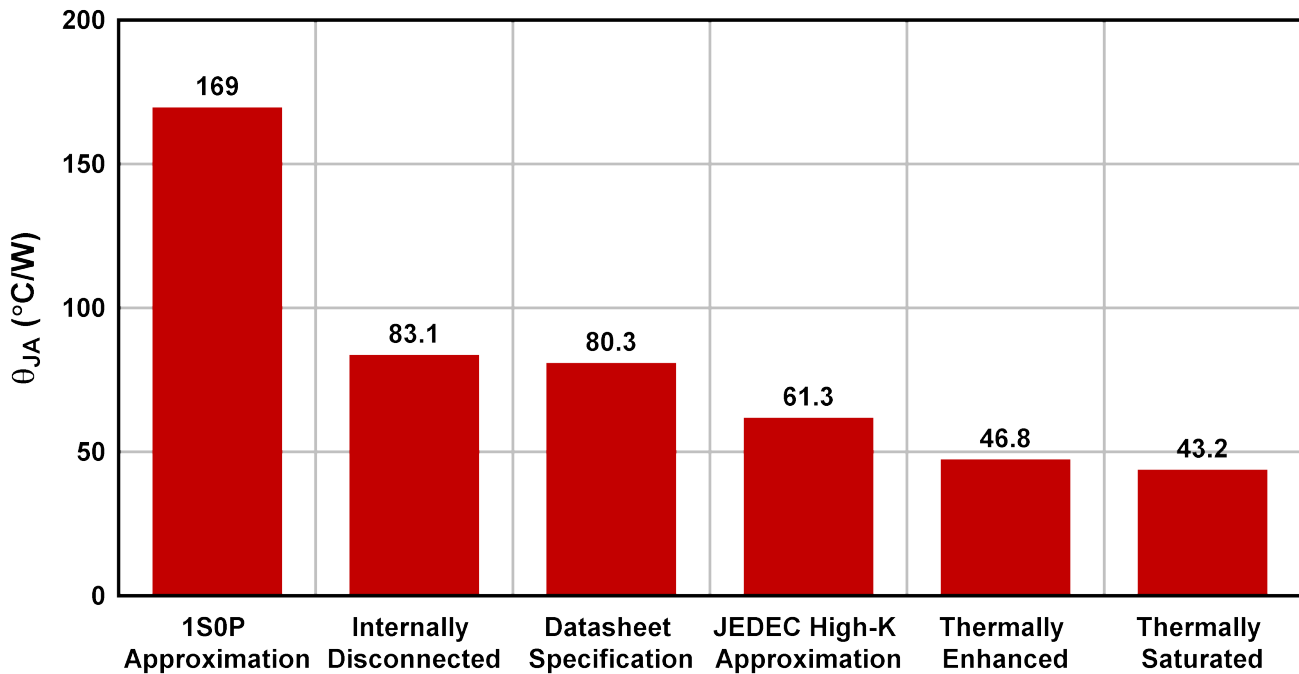

**Figure 8-8. TPS745-Q1 (WSN)  $R_{\theta JA}$  versus Board Layout**

### 8.1.7 Power-Good Function

The power-good circuit monitors the voltage at the feedback pin to indicate the status of the output voltage. When the output voltage falls below the PG threshold voltage ( $PG_{LTH}$ ), the PG pin open-drain output engages and pulls the PG pin close to GND. When the output voltage exceeds  $PG_{HTH}$ , the PG pin becomes high impedance. The open-drain output requires a pullup resistor. By connecting a pullup resistor to an external supply, any downstream device can receive power-good as a logic signal that can be used for sequencing. Additionally, the open-drain output can be tied to other open-drain outputs to implement AND logic. Make sure that the external pullup supply voltage results in a valid logic signal for the receiving device. Using a pullup resistor from 10 k $\Omega$  to 100 k $\Omega$  is recommended. The push-pull power-good option does not require the pullup resistor and instead has a high logic signal that correlates with the output voltage of the device. The push-pull option is supported only for  $V_{OUT} \geq 1.0$  V. The push-pull option is supported only for  $V_{OUT} \geq 1.0$  V. Do not tie the push-pull output to other logic outputs.

When using a feed-forward capacitor ( $C_{FF}$ ), the time constant for the LDO start-up is increased whereas the power-good output time constant stays the same, possibly resulting in an invalid status of the power-good output. To avoid this issue, and to receive a valid PG output, make sure that the time constant of both the LDO start-up and the power-good output match, which can be done by adding a capacitor in parallel with the power-good pullup resistor. For more information, see the [Pros and Cons of Using a Feedforward Capacitor with a Low-Dropout Regulator application report](#).

The state of PG is only valid when the TPS745-Q1 operates above the minimum input voltage of the device and power-good is asserted, regardless of the output voltage state when the input voltage falls below the UVLO threshold minus the UVLO hysteresis. When the input voltage falls below approximately 0.8 V, there is not enough gate drive voltage to keep the open-drain, power-good device turned on and the power-good output pulled high. Connecting the power-good pullup resistor to the output voltage can help minimize this effect.

### 8.1.8 Feed-Forward Capacitor ( $C_{FF}$ )

For the adjustable-voltage version device, a feed-forward capacitor ( $C_{FF}$ ) can be connected from the OUT pin to the FB pin.  $C_{FF}$  improves transient, noise, and PSRR performance, but is not required for regulator stability. Recommended  $C_{FF}$  values are listed in the *Recommended Operating Conditions* table. A higher capacitance  $C_{FF}$  can be used; however, the startup time increases. For a detailed description of  $C_{FF}$  tradeoffs, see the [Pros and Cons of Using a Feedforward Capacitor with a Low-Dropout Regulator application report](#).

### 8.1.9 Start-Up Sequencing

If  $V_{EN}$  is greater than  $V_{UVLO}$  rising (min), the input pin (IN) must sink 1 mA of current to avoid the device being turned on with a floating input pin.

## 8.2 Typical Application

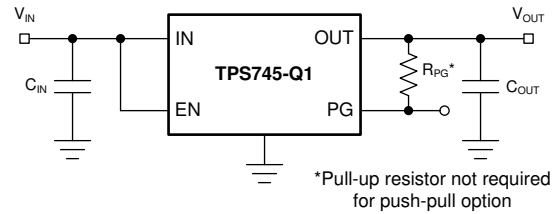

**Figure 8-9. TPS745-Q1 Typical Application**

### 8.2.1 Design Requirements

Table 8-1 summarizes the design requirements for Figure 8-9.

**Table 8-1. Design Parameters**

PARAMETER	DESIGN REQUIREMENT
Input voltage	3.3 V
Output voltage	1.8 V, ±1%
Input current	300 mA, maximum
Output load	300-mA DC
Maximum ambient temperature	105°C

### 8.2.2 Detailed Design Procedure

Input and output capacitors are required to achieve the output voltage transient requirements. Capacitance values of 2.2 µF are selected to give the maximum output capacitance in a small, low-cost package; see the [Input and Output Capacitor Selection](#) section for details.

#### 8.2.2.1 Input Current

During normal operation, the input current to the LDO is approximately equal to the output current of the LDO. During start-up, the input current is higher as a result of the inrush current charging the output capacitor. Use Equation 6 to calculate the current through the input.

$$I_{OUT(t)} = \left[ \frac{C_{OUT} \times dV_{OUT(t)}}{dt} \right] + \left[ \frac{V_{OUT(t)}}{R_{LOAD}} \right] \quad (6)$$

where:

- $V_{OUT(t)}$  is the instantaneous output voltage of the turn-on ramp
- $dV_{OUT(t)} / dt$  is the slope of the  $V_{OUT}$  ramp
- $R_{LOAD}$  is the resistive load impedance

### 8.2.2.2 Thermal Dissipation

The junction temperature can be determined using the junction-to-ambient thermal resistance ( $R_{\theta JA}$ ) and the total power dissipation ( $P_D$ ). Use Equation 7 to calculate the power dissipation. Multiply  $P_D$  by  $R_{\theta JA}$  as Equation 8 shows and add the ambient temperature ( $T_A$ ) to calculate the junction temperature ( $T_J$ ).

$$P_D = (I_{GND} + I_{OUT}) \times (V_{IN} - V_{OUT}) \quad (7)$$

$$T_J = R_{\theta JA} \times P_D + T_A \quad (8)$$

Calculate the maximum ambient temperature according to Equation 9 and Equation 10. The maximum ambient temperature is 113.86°C for the example conditions.

$$T_{A(MAX)} = T_{J(MAX)} - R_{\theta JA} \times P_D \quad (9)$$

$$T_{A(MAX)} = 150^\circ\text{C} - 80.3^\circ\text{C/W} \times (3.3\text{ V} - 1.8\text{ V}) \times (0.3\text{ A}) = 113.86^\circ\text{C} \quad (10)$$

### 8.2.3 Application Curves

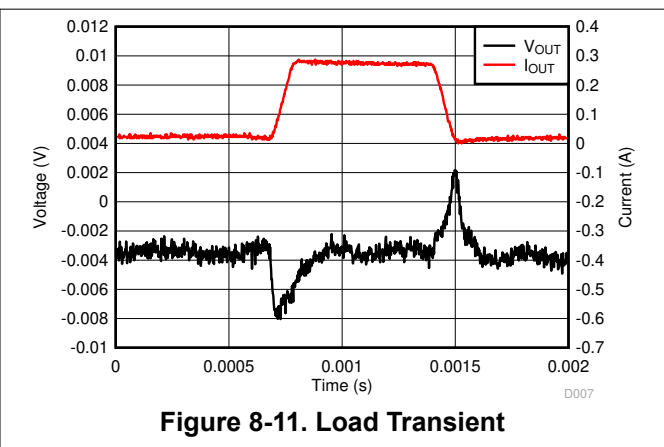
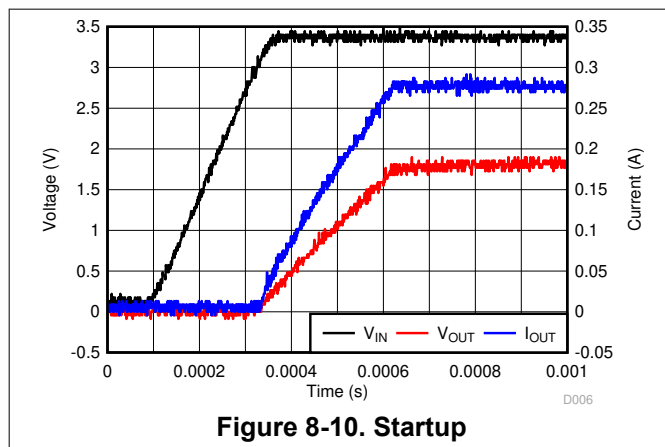

## 9 Power Supply Recommendations

The TPS745-Q1 is designed to operate from an input voltage supply range from 1.5 V to 6.0 V. The input voltage range provides adequate headroom for the device to have a regulated output. This input supply must be well regulated. If the input supply is noisy, additional input capacitors with low ESR can help improve output noise performance. Connect a low output impedance power supply directly to the IN pin of the TPS745-Q1.

## 10 Layout

### 10.1 Layout Guidelines

- Place input and output capacitors as close to the device as possible.
- Use copper planes for device connections to optimize thermal performance.
- Place thermal vias around the device to distribute heat.
- Only place tented thermal vias directly beneath the thermal pad of the DRV or DRB package. An untented via can wick solder or solder paste away from the thermal pad joint during the soldering process, leading to a compromised solder joint on the thermal pad.

### 10.2 Layout Examples

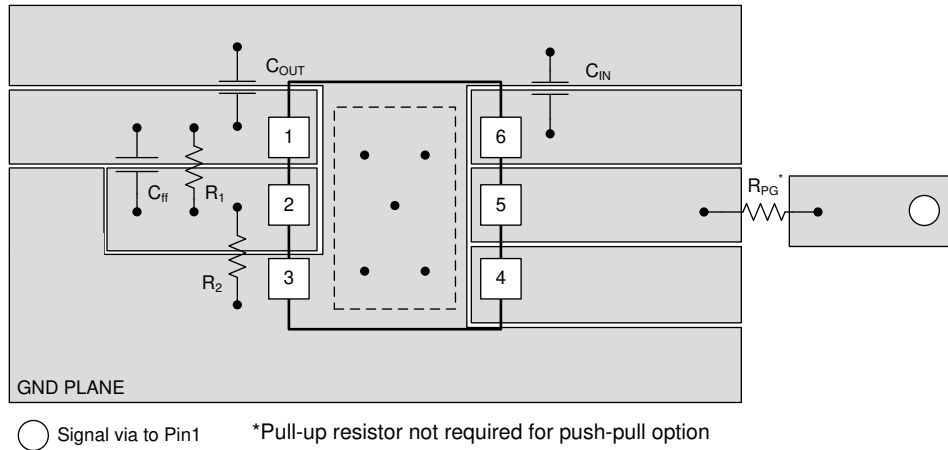

**Figure 10-1. Layout Example for the DRV Package**

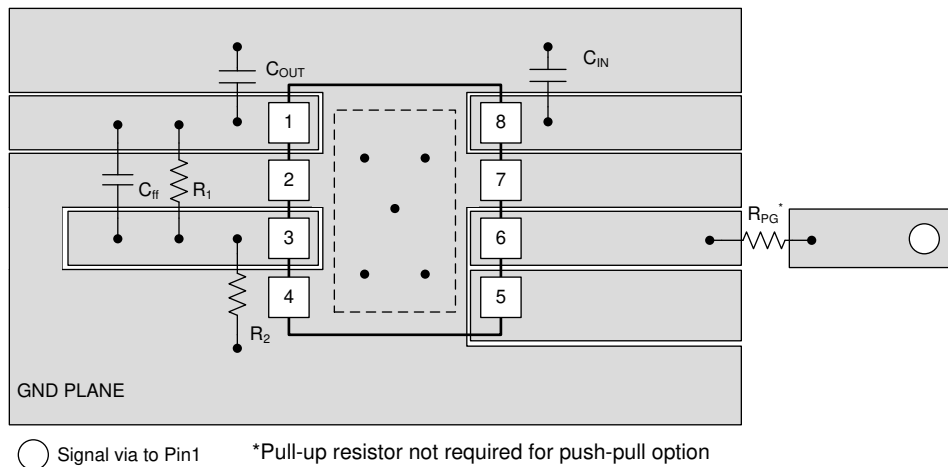

**Figure 10-2. Layout Example for the DRB Package**

## 11 Device and Documentation Support

### 11.1 Device Support

#### 11.1.1 Device Nomenclature

**Table 11-1. Device Nomenclature<sup>(1) (2)</sup>**

PRODUCT	V <sub>OUT</sub>
TPS745xx(x)PvQWyyyzQ1	<p><b>xx(x)</b> is the nominal output voltage. For output voltages with a resolution of 100 mV, two digits are used in the ordering number; otherwise, three digits are used (for example, 28 = 2.8 V; 125 = 1.25 V; 01 = adjustable).</p> <p><b>P</b> indicates an active output discharge feature. All members of the TPS745-Q1 family actively discharge the output when the device is disabled.</p> <p><b>v</b> indicates the topology of the power-good output and the timing associated with the power-good delay.</p> <ul style="list-style-type: none"> <li>If unused, indicates an open-drain power-good output with a 150-<math>\mu</math>s delay.</li> <li>If <b>B</b>, indicates a open-drain power-good output with a 5-ms delay.</li> <li>If <b>C</b>, indicates a push-pull power-good output with a 150-<math>\mu</math>s delay.</li> </ul> <p><b>Q</b> indicates that this device is a Grade-1 device in accordance with the AEC-Q100 standard.</p> <p><b>W</b> indicates the package has wettable flanks.</p> <p><b>yyy</b> is the package designator.</p> <p><b>z</b> is the package quantity. R is for reel (3000 pieces), T is for tape (250 pieces).</p> <p><b>Q1</b> indicates that this device is an automotive grade (AEC-Q100) device.</p>

- (1) For the most current package and ordering information see the Package Option Addendum at the end of this document, or visit the device product folder on [www.ti.com](http://www.ti.com).
- (2) Output voltages from 0.65 V to 5.0 V in 50-mV increments are available. Contact the factory for details and availability.

### 11.2 Documentation Support

#### 11.2.1 Related Documentation

For related documentation see the following:

- Texas Instruments, [An empirical analysis of the impact of board layout on LDO thermal performance application report](#)
- Texas Instruments, [Pros and Cons of Using a Feedforward Capacitor with a Low-Dropout Regulator application report](#)

### 11.3 Receiving Notification of Documentation Updates

To receive notification of documentation updates, navigate to the device product folder on [ti.com](http://ti.com). Click on *Subscribe to updates* to register and receive a weekly digest of any product information that has changed. For change details, review the revision history included in any revised document.

### 11.4 Support Resources

[TI E2E™ support forums](#) are an engineer's go-to source for fast, verified answers and design help — straight from the experts. Search existing answers or ask your own question to get the quick design help you need.

Linked content is provided "AS IS" by the respective contributors. They do not constitute TI specifications and do not necessarily reflect TI's views; see TI's [Terms of Use](#).

### 11.5 Trademarks

TI E2E™ is a trademark of Texas Instruments.

All trademarks are the property of their respective owners.

### 11.6 Electrostatic Discharge Caution



This integrated circuit can be damaged by ESD. Texas Instruments recommends that all integrated circuits be handled with appropriate precautions. Failure to observe proper handling and installation procedures can cause damage.

ESD damage can range from subtle performance degradation to complete device failure. Precision integrated circuits may be more susceptible to damage because very small parametric changes could cause the device not to meet its published specifications.

## 11.7 Glossary

[TI Glossary](#) This glossary lists and explains terms, acronyms, and definitions.

## Mechanical, Packaging, and Orderable Information

The following pages include mechanical, packaging, and orderable information. This information is the most current data available for the designated devices. This data is subject to change without notice and revision of this document. For browser-based versions of this data sheet, refer to the left-hand navigation.

**PACKAGING INFORMATION**

Orderable Device	Status (1)	Package Type	Package Drawing	Pins	Package Qty	Eco Plan (2)	Lead finish/ Ball material (6)	MSL Peak Temp (3)	Op Temp (°C)	Device Marking (4/5)	Samples
TPS74501PBQWDRVRQ1	ACTIVE	WSON	DRV	6	3000	RoHS & Green	Call TI	Level-1-260C-UNLIM	-40 to 125	1S36	<a href="#">Samples</a>
TPS74501PCQWDRVRQ1	ACTIVE	WSON	DRV	6	3000	RoHS & Green	Call TI	Level-1-260C-UNLIM	-40 to 125	1ZF6	<a href="#">Samples</a>
TPS74501PQWDRBRQ1	ACTIVE	SON	DRB	8	3000	RoHS & Green	NIPDAU	Level-2-260C-1 YEAR	-40 to 125	74501P	<a href="#">Samples</a>
TPS74501PQWDRVRQ1	ACTIVE	WSON	DRV	6	3000	RoHS & Green	SN	Level-1-260C-UNLIM	-40 to 125	1S26	<a href="#">Samples</a>
TPS74507PQWDRBRQ1	PREVIEW	SON	DRB	8	3000	TBD	Call TI	Call TI	-40 to 125		
TPS745105PQWDRVRQ1	ACTIVE	WSON	DRV	6	3000	RoHS & Green	Call TI	Level-1-260C-UNLIM	-40 to 125	1S66	<a href="#">Samples</a>
TPS74510PQWDRBRQ1	ACTIVE	SON	DRB	8	3000	RoHS & Green	NIPDAU	Level-2-260C-1 YEAR	-40 to 125	74510P	<a href="#">Samples</a>
TPS74510PQWDRVRQ1	ACTIVE	WSON	DRV	6	3000	RoHS & Green	SN	Level-1-260C-UNLIM	-40 to 125	1S56	<a href="#">Samples</a>
TPS745115PQWDRBRQ1	ACTIVE	SON	DRB	8	3000	RoHS & Green	NIPDAU	Level-2-260C-1 YEAR	-40 to 125	745115	<a href="#">Samples</a>
TPS74511PQWDRBRQ1	ACTIVE	SON	DRB	8	3000	RoHS & Green	NIPDAU	Level-2-260C-1 YEAR	-40 to 125	74511P	<a href="#">Samples</a>
TPS74511PQWDRVRQ1	ACTIVE	WSON	DRV	6	3000	RoHS & Green	SN	Level-1-260C-UNLIM	-40 to 125	1S76	<a href="#">Samples</a>
TPS745125PQWDRBRQ1	ACTIVE	SON	DRB	8	3000	RoHS & Green	NIPDAU	Level-2-260C-1 YEAR	-40 to 125	745125	<a href="#">Samples</a>
TPS74512PQWDRBRQ1	ACTIVE	SON	DRB	8	3000	RoHS & Green	NIPDAU	Level-2-260C-1 YEAR	-40 to 125	74512P	<a href="#">Samples</a>
TPS74512PQWDRVRQ1	ACTIVE	WSON	DRV	6	3000	RoHS & Green	SN	Level-1-260C-UNLIM	-40 to 125	1S86	<a href="#">Samples</a>
TPS745135PQWDRBRQ1	ACTIVE	SON	DRB	8	3000	RoHS & Green	NIPDAU	Level-2-260C-1 YEAR	-40 to 125	745135	<a href="#">Samples</a>
TPS74513PQWDRBRQ1	ACTIVE	SON	DRB	8	3000	RoHS & Green	NIPDAU	Level-2-260C-1 YEAR	-40 to 125	74513P	<a href="#">Samples</a>
TPS74515PQWDRBRQ1	ACTIVE	SON	DRB	8	3000	RoHS & Green	NIPDAU	Level-2-260C-1 YEAR	-40 to 125	74515P	<a href="#">Samples</a>
TPS74515PQWDRVRQ1	ACTIVE	WSON	DRV	6	3000	RoHS & Green	SN	Level-1-260C-UNLIM	-40 to 125	1S96	<a href="#">Samples</a>
TPS74517PQWDRBRQ1	ACTIVE	SON	DRB	8	3000	RoHS & Green	NIPDAU	Level-2-260C-1 YEAR	-40 to 125	74517P	<a href="#">Samples</a>
TPS74518PQWDRBRQ1	ACTIVE	SON	DRB	8	3000	RoHS & Green	NIPDAU	Level-2-260C-1 YEAR	-40 to 125	74518P	<a href="#">Samples</a>



Orderable Device	Status (1)	Package Type	Package Drawing	Pins	Package Qty	Eco Plan (2)	Lead finish/ Ball material (6)	MSL Peak Temp (3)	Op Temp (°C)	Device Marking (4/5)	Samples
TPS74518PQWDRVRQ1	ACTIVE	WSON	DRV	6	3000	RoHS & Green	SN	Level-1-260C-UNLIM	-40 to 125	1SA6	<a href="#">Samples</a>
TPS74522PQWDRVRQ1	ACTIVE	WSON	DRV	6	3000	RoHS & Green	SN	Level-1-260C-UNLIM	-40 to 125	1SB6	<a href="#">Samples</a>
TPS74525PQWDRBRQ1	ACTIVE	SON	DRB	8	3000	RoHS & Green	NIPDAU	Level-2-260C-1 YEAR	-40 to 125	74525P	<a href="#">Samples</a>
TPS74525PQWDRVRQ1	ACTIVE	WSON	DRV	6	3000	RoHS & Green	SN	Level-1-260C-UNLIM	-40 to 125	1SC6	<a href="#">Samples</a>
TPS74528PQWDRVRQ1	ACTIVE	WSON	DRV	6	3000	RoHS & Green	SN	Level-1-260C-UNLIM	-40 to 125	1SD6	<a href="#">Samples</a>
TPS74529PQWDRBRQ1	PREVIEW	SON	DRB	8	3000	TBD	Call TI	Call TI	-40 to 125		
TPS74529PQWDRVRQ1	ACTIVE	WSON	DRV	6	3000	RoHS & Green	SN	Level-1-260C-UNLIM	-40 to 125	1SE6	<a href="#">Samples</a>
TPS74530PQWDRBRQ1	ACTIVE	SON	DRB	8	3000	RoHS & Green	NIPDAU	Level-2-260C-1 YEAR	-40 to 125	74530P	<a href="#">Samples</a>
TPS74533PCQWDRVRQ1	ACTIVE	WSON	DRV	6	3000	RoHS & Green	Call TI	Level-1-260C-UNLIM	-40 to 125	1ZE6	<a href="#">Samples</a>
TPS74533PQWDRBRQ1	ACTIVE	SON	DRB	8	3000	RoHS & Green	NIPDAU	Level-2-260C-1 YEAR	-40 to 125	74533P	<a href="#">Samples</a>
TPS74533PQWDRVRQ1	ACTIVE	WSON	DRV	6	3000	RoHS & Green	SN	Level-1-260C-UNLIM	-40 to 125	1SF6	<a href="#">Samples</a>
TPS74534PQWDRBRQ1	ACTIVE	SON	DRB	8	3000	RoHS & Green	NIPDAU	Level-2-260C-1 YEAR	-40 to 125	74534P	<a href="#">Samples</a>
TPS74550PQWDRBRQ1	ACTIVE	SON	DRB	8	3000	RoHS & Green	NIPDAU	Level-2-260C-1 YEAR	-40 to 125	74550P	<a href="#">Samples</a>
TPS74550PQWDRVRQ1	ACTIVE	WSON	DRV	6	3000	RoHS & Green	SN	Level-1-260C-UNLIM	-40 to 125	1T36	<a href="#">Samples</a>

(1) The marketing status values are defined as follows:

**ACTIVE:** Product device recommended for new designs.

**LIFEBUY:** TI has announced that the device will be discontinued, and a lifetime-buy period is in effect.

**NRND:** Not recommended for new designs. Device is in production to support existing customers, but TI does not recommend using this part in a new design.

**PREVIEW:** Device has been announced but is not in production. Samples may or may not be available.

**OBSELETE:** TI has discontinued the production of the device.

(2) **RoHS:** TI defines "RoHS" to mean semiconductor products that are compliant with the current EU RoHS requirements for all 10 RoHS substances, including the requirement that RoHS substance do not exceed 0.1% by weight in homogeneous materials. Where designed to be soldered at high temperatures, "RoHS" products are suitable for use in specified lead-free processes. TI may reference these types of products as "Pb-Free".

**RoHS Exempt:** TI defines "RoHS Exempt" to mean products that contain lead but are compliant with EU RoHS pursuant to a specific EU RoHS exemption.

**Green:** TI defines "Green" to mean the content of Chlorine (Cl) and Bromine (Br) based flame retardants meet JS709B low halogen requirements of <=1000ppm threshold. Antimony trioxide based flame retardants must also meet the <=1000ppm threshold requirement.

(3) MSL, Peak Temp. - The Moisture Sensitivity Level rating according to the JEDEC industry standard classifications, and peak solder temperature.

(4) There may be additional marking, which relates to the logo, the lot trace code information, or the environmental category on the device.

(5) Multiple Device Markings will be inside parentheses. Only one Device Marking contained in parentheses and separated by a "~" will appear on a device. If a line is indented then it is a continuation of the previous line and the two combined represent the entire Device Marking for that device.

(6) Lead finish/Ball material - Orderable Devices may have multiple material finish options. Finish options are separated by a vertical ruled line. Lead finish/Ball material values may wrap to two lines if the finish value exceeds the maximum column width.

**Important Information and Disclaimer:**The information provided on this page represents TI's knowledge and belief as of the date that it is provided. TI bases its knowledge and belief on information provided by third parties, and makes no representation or warranty as to the accuracy of such information. Efforts are underway to better integrate information from third parties. TI has taken and continues to take reasonable steps to provide representative and accurate information but may not have conducted destructive testing or chemical analysis on incoming materials and chemicals. TI and TI suppliers consider certain information to be proprietary, and thus CAS numbers and other limited information may not be available for release.

In no event shall TI's liability arising out of such information exceed the total purchase price of the TI part(s) at issue in this document sold by TI to Customer on an annual basis.

**OTHER QUALIFIED VERSIONS OF TPS745-Q1 :**

- Catalog : [TPS745](#)

NOTE: Qualified Version Definitions:

- Catalog - TI's standard catalog product

**TAPE AND REEL INFORMATION**

**QUADRANT ASSIGNMENTS FOR PIN 1 ORIENTATION IN TAPE**

\*All dimensions are nominal

Device	Package Type	Package Drawing	Pins	SPQ	Reel Diameter (mm)	Reel Width W1 (mm)	A0 (mm)	B0 (mm)	K0 (mm)	P1 (mm)	W (mm)	Pin1 Quadrant
TPS74501PBQWDRVRQ1	WSON	DRV	6	3000	180.0	8.4	2.2	2.2	1.2	4.0	8.0	Q2
TPS74501PCQWDRVRQ1	WSON	DRV	6	3000	180.0	8.4	2.2	2.2	1.2	4.0	8.0	Q2
TPS74501PQWDRBRQ1	SON	DRB	8	3000	330.0	12.4	3.3	3.3	1.1	8.0	12.0	Q2
TPS74501PQWDRVRQ1	WSON	DRV	6	3000	180.0	8.4	2.2	2.2	1.2	4.0	8.0	Q2
TPS745105PQWDRVRQ1	WSON	DRV	6	3000	180.0	8.4	2.2	2.2	1.2	4.0	8.0	Q2
TPS74510PQWDRBRQ1	SON	DRB	8	3000	330.0	12.4	3.3	3.3	1.1	8.0	12.0	Q2
TPS74510PQWDRVRQ1	WSON	DRV	6	3000	180.0	8.4	2.2	2.2	1.2	4.0	8.0	Q2
TPS745115PQWDRBRQ1	SON	DRB	8	3000	330.0	12.4	3.3	3.3	1.1	8.0	12.0	Q2
TPS74511PQWDRBRQ1	SON	DRB	8	3000	330.0	12.4	3.3	3.3	1.1	8.0	12.0	Q2
TPS74511PQWDRVRQ1	WSON	DRV	6	3000	180.0	8.4	2.2	2.2	1.2	4.0	8.0	Q2
TPS745125PQWDRBRQ1	SON	DRB	8	3000	330.0	12.4	3.3	3.3	1.1	8.0	12.0	Q2
TPS74512PQWDRBRQ1	SON	DRB	8	3000	330.0	12.4	3.3	3.3	1.1	8.0	12.0	Q2
TPS74512PQWDRVRQ1	WSON	DRV	6	3000	180.0	8.4	2.2	2.2	1.2	4.0	8.0	Q2
TPS745135PQWDRBRQ1	SON	DRB	8	3000	330.0	12.4	3.3	3.3	1.1	8.0	12.0	Q2
TPS74513PQWDRBRQ1	SON	DRB	8	3000	330.0	12.4	3.3	3.3	1.1	8.0	12.0	Q2
TPS74515PQWDRBRQ1	SON	DRB	8	3000	330.0	12.4	3.3	3.3	1.1	8.0	12.0	Q2

Device	Package Type	Package Drawing	Pins	SPQ	Reel Diameter (mm)	Reel Width W1 (mm)	A0 (mm)	B0 (mm)	K0 (mm)	P1 (mm)	W (mm)	Pin1 Quadrant
TPS74515PQWDRVRQ1	WSON	DRV	6	3000	180.0	8.4	2.2	2.2	1.2	4.0	8.0	Q2
TPS74517PQWDRBRQ1	SON	DRB	8	3000	330.0	12.4	3.3	3.3	1.1	8.0	12.0	Q2
TPS74518PQWDRBRQ1	SON	DRB	8	3000	330.0	12.4	3.3	3.3	1.1	8.0	12.0	Q2
TPS74518PQWDRVRQ1	WSON	DRV	6	3000	180.0	8.4	2.2	2.2	1.2	4.0	8.0	Q2
TPS74522PQWDRVRQ1	WSON	DRV	6	3000	180.0	8.4	2.2	2.2	1.2	4.0	8.0	Q2
TPS74525PQWDRBRQ1	SON	DRB	8	3000	330.0	12.4	3.3	3.3	1.1	8.0	12.0	Q2
TPS74525PQWDRVRQ1	WSON	DRV	6	3000	180.0	8.4	2.2	2.2	1.2	4.0	8.0	Q2
TPS74528PQWDRVRQ1	WSON	DRV	6	3000	180.0	8.4	2.2	2.2	1.2	4.0	8.0	Q2
TPS74529PQWDRVRQ1	WSON	DRV	6	3000	180.0	8.4	2.2	2.2	1.2	4.0	8.0	Q2
TPS74530PQWDRBRQ1	SON	DRB	8	3000	330.0	12.4	3.3	3.3	1.1	8.0	12.0	Q2
TPS74533PCQWDRVRQ1	WSON	DRV	6	3000	180.0	8.4	2.2	2.2	1.2	4.0	8.0	Q2
TPS74533PQWDRBRQ1	SON	DRB	8	3000	330.0	12.4	3.3	3.3	1.1	8.0	12.0	Q2
TPS74533PQWDRVRQ1	WSON	DRV	6	3000	180.0	8.4	2.2	2.2	1.2	4.0	8.0	Q2
TPS74534PQWDRBRQ1	SON	DRB	8	3000	330.0	12.4	3.3	3.3	1.1	8.0	12.0	Q2
TPS74550PQWDRBRQ1	SON	DRB	8	3000	330.0	12.4	3.3	3.3	1.1	8.0	12.0	Q2
TPS74550PQWDRVRQ1	WSON	DRV	6	3000	180.0	8.4	2.2	2.2	1.2	4.0	8.0	Q2

**TAPE AND REEL BOX DIMENSIONS**

\*All dimensions are nominal

Device	Package Type	Package Drawing	Pins	SPQ	Length (mm)	Width (mm)	Height (mm)
TPS74501PBQWDRVRQ1	WSON	DRV	6	3000	200.0	183.0	25.0
TPS74501PCQWDRVRQ1	WSON	DRV	6	3000	200.0	183.0	25.0
TPS74501PQWDRBRQ1	SON	DRB	8	3000	367.0	367.0	35.0
TPS74501PQWDRVRQ1	WSON	DRV	6	3000	200.0	183.0	25.0
TPS745105PQWDRVRQ1	WSON	DRV	6	3000	200.0	183.0	25.0
TPS74510PQWDRBRQ1	SON	DRB	8	3000	367.0	367.0	35.0
TPS74510PQWDRVRQ1	WSON	DRV	6	3000	200.0	183.0	25.0
TPS745115PQWDRBRQ1	SON	DRB	8	3000	367.0	367.0	35.0
TPS74511PQWDRBRQ1	SON	DRB	8	3000	367.0	367.0	35.0
TPS74511PQWDRVRQ1	WSON	DRV	6	3000	200.0	183.0	25.0
TPS745125PQWDRBRQ1	SON	DRB	8	3000	367.0	367.0	35.0
TPS74512PQWDRBRQ1	SON	DRB	8	3000	367.0	367.0	35.0
TPS74512PQWDRVRQ1	WSON	DRV	6	3000	200.0	183.0	25.0
TPS745135PQWDRBRQ1	SON	DRB	8	3000	367.0	367.0	35.0
TPS74513PQWDRBRQ1	SON	DRB	8	3000	367.0	367.0	35.0
TPS74515PQWDRBRQ1	SON	DRB	8	3000	367.0	367.0	35.0
TPS74515PQWDRVRQ1	WSON	DRV	6	3000	200.0	183.0	25.0
TPS74517PQWDRBRQ1	SON	DRB	8	3000	367.0	367.0	35.0

Device	Package Type	Package Drawing	Pins	SPQ	Length (mm)	Width (mm)	Height (mm)
TPS74518PQWDRBRQ1	SON	DRB	8	3000	367.0	367.0	35.0
TPS74518PQWDRVRQ1	WSON	DRV	6	3000	200.0	183.0	25.0
TPS74522PQWDRVRQ1	WSON	DRV	6	3000	200.0	183.0	25.0
TPS74525PQWDRBRQ1	SON	DRB	8	3000	367.0	367.0	35.0
TPS74525PQWDRVRQ1	WSON	DRV	6	3000	200.0	183.0	25.0
TPS74528PQWDRVRQ1	WSON	DRV	6	3000	200.0	183.0	25.0
TPS74529PQWDRVRQ1	WSON	DRV	6	3000	200.0	183.0	25.0
TPS74530PQWDRBRQ1	SON	DRB	8	3000	367.0	367.0	35.0
TPS74533PCQWDRVRQ1	WSON	DRV	6	3000	200.0	183.0	25.0
TPS74533PQWDRBRQ1	SON	DRB	8	3000	367.0	367.0	35.0
TPS74533PQWDRVRQ1	WSON	DRV	6	3000	200.0	183.0	25.0
TPS74534PQWDRBRQ1	SON	DRB	8	3000	367.0	367.0	35.0
TPS74550PQWDRBRQ1	SON	DRB	8	3000	367.0	367.0	35.0
TPS74550PQWDRVRQ1	WSON	DRV	6	3000	200.0	183.0	25.0

## GENERIC PACKAGE VIEW

DRV 6

WSON - 0.8 mm max height

PLASTIC SMALL OUTLINE - NO LEAD



Images above are just a representation of the package family, actual package may vary.  
Refer to the product data sheet for package details.

4206925/F

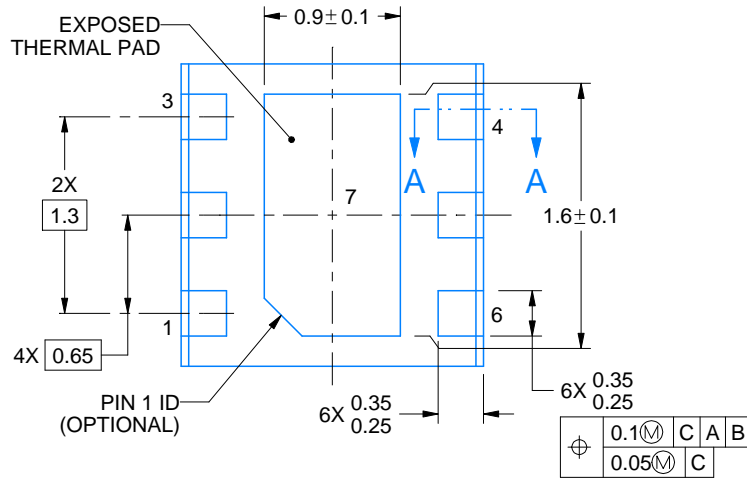
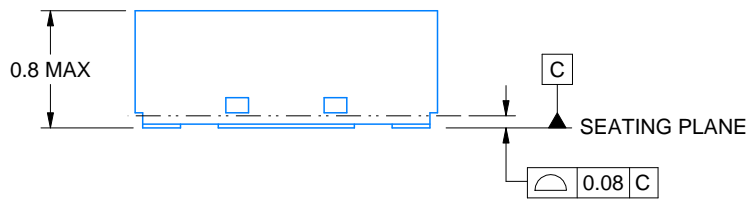
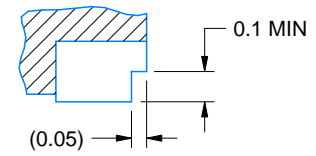
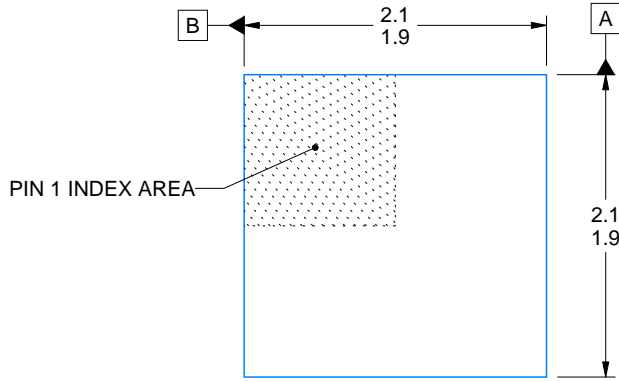

4223939/A 09/2017

NOTES:

1. All linear dimensions are in millimeters. Any dimensions in parenthesis are for reference only. Dimensioning and tolerancing per ASME Y14.5M.
2. This drawing is subject to change without notice.



# EXAMPLE BOARD LAYOUT

DRV0006C

WSON - 0.8 mm max height

PLASTIC SMALL OUTLINE - NO LEAD

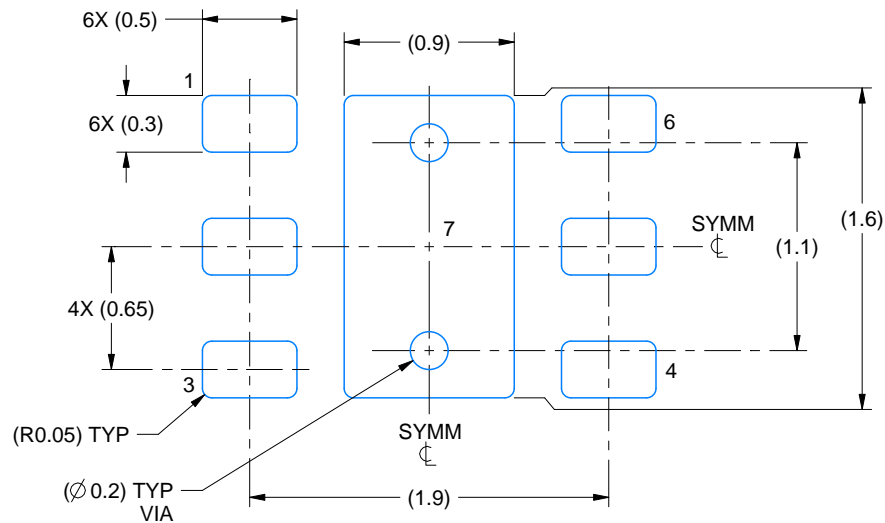

LAND PATTERN EXAMPLE  
EXPOSED METAL SHOWN  
SCALE:25X

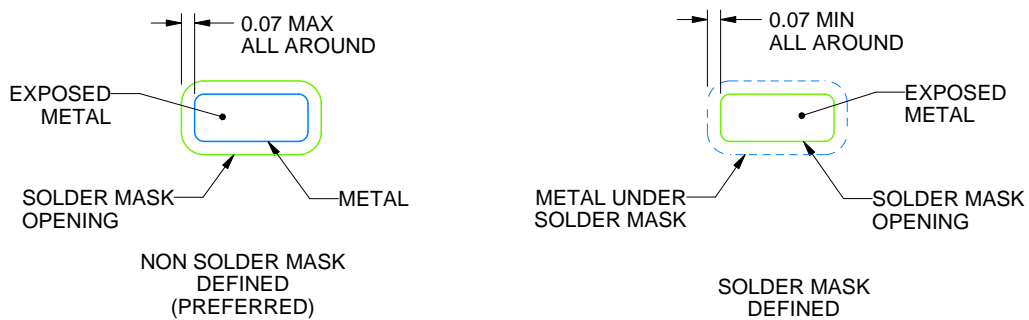

SOLDER MASK DETAILS

4223939/A 09/2017

NOTES: (continued)

3. For more information, see Texas Instruments literature number SLUA271 ([www.ti.com/lit/slua271](http://www.ti.com/lit/slua271)).
4. Vias are optional depending on application, refer to device data sheet. If any vias are implemented, refer to their locations shown on this view. It is recommended that vias under paste be filled, plugged or tented.

# EXAMPLE STENCIL DESIGN

DRV0006C

WSON - 0.8 mm max height

PLASTIC SMALL OUTLINE - NO LEAD

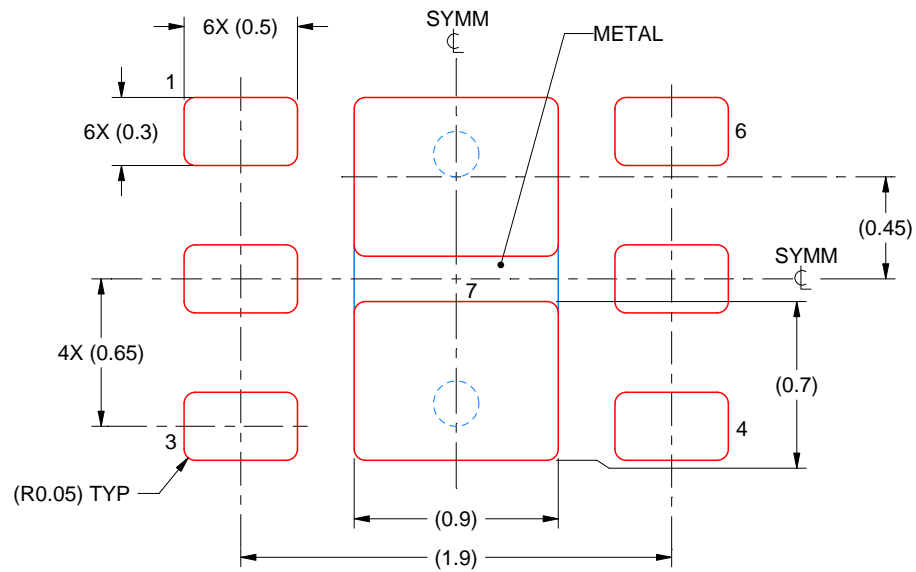

SOLDER PASTE EXAMPLE  
BASED ON 0.125 mm THICK STENCIL

EXPOSED PAD #7:  
88% PRINTED SOLDER COVERAGE BY AREA UNDER PACKAGE  
SCALE:30X

4223939/A 09/2017

NOTES: (continued)

5. Laser cutting apertures with trapezoidal walls and rounded corners may offer better paste release. IPC-7525 may have alternate design recommendations.

**DRB 8**

**GENERIC PACKAGE VIEW**

**VSON - 1 mm max height**

PLASTIC SMALL OUTLINE - NO LEAD



Images above are just a representation of the package family, actual package may vary.  
Refer to the product data sheet for package details.

4203482/L

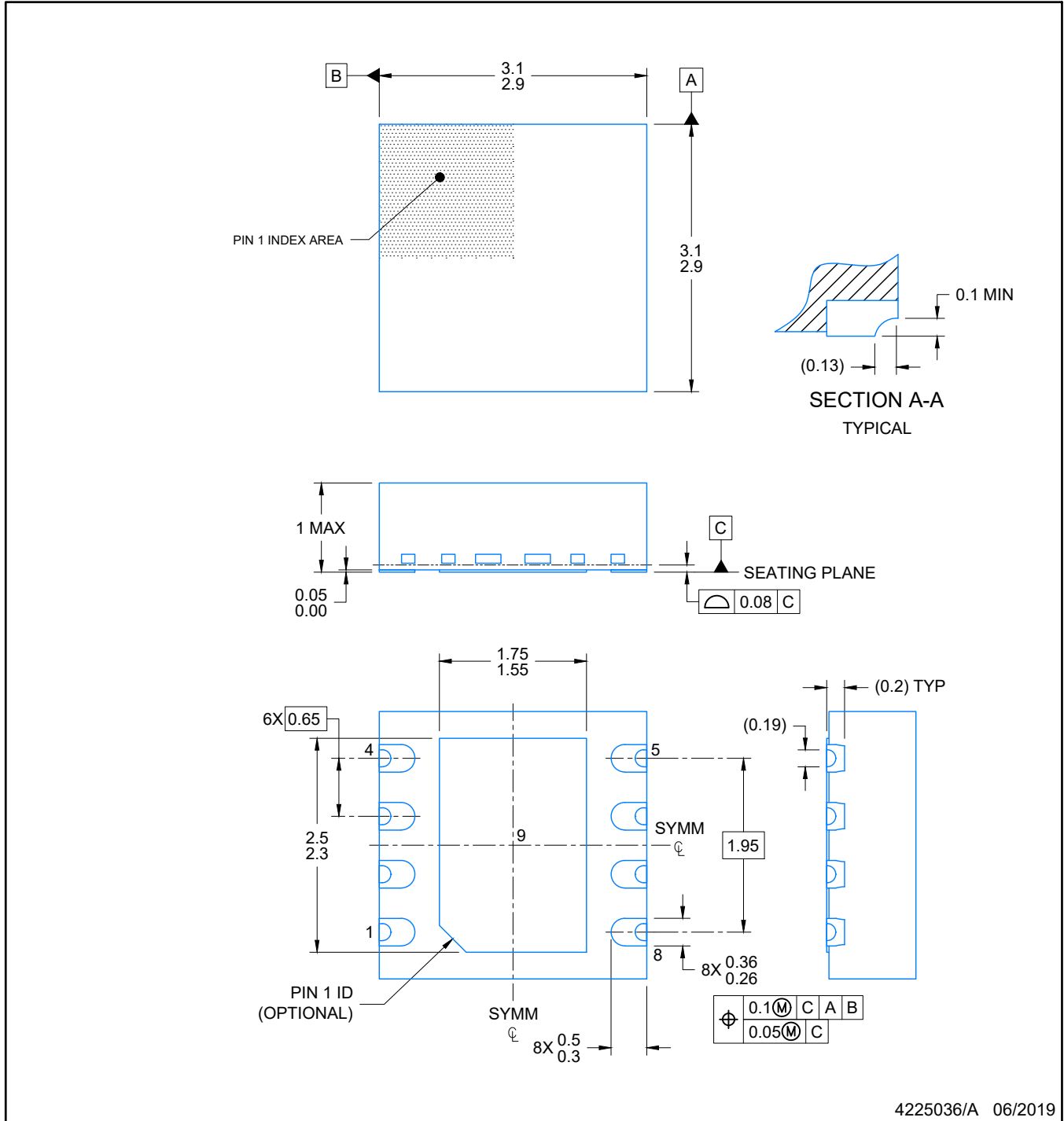

4225036/A 06/2019

NOTES:

1. All linear dimensions are in millimeters. Any dimensions in parenthesis are for reference only. Dimensioning and tolerancing per ASME Y14.5M.
2. This drawing is subject to change without notice.
3. The package thermal pad must be soldered to the printed circuit board for optimal thermal and mechanical performance.

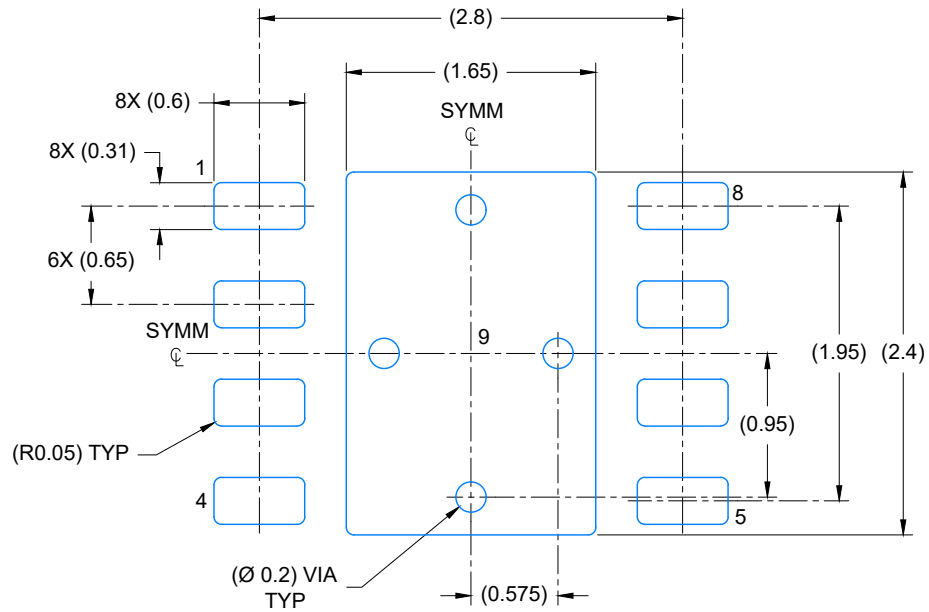

LAND PATTERN EXAMPLE  
EXPOSED METAL SHOWN  
SCALE: 20X

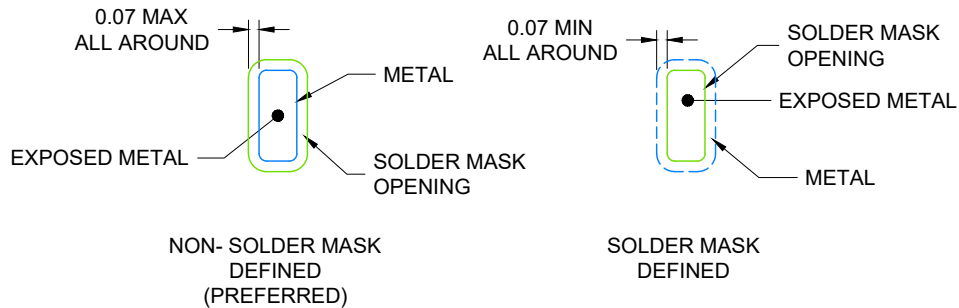

SOLDER MASK DETAILS

4225036/A 06/2019

NOTES: (continued)

4. This package is designed to be soldered to a thermal pad on the board. For more information, see Texas Instruments literature number SLUA271 ([www.ti.com/lit/sluea271](http://www.ti.com/lit/sluea271)).
5. Vias are optional depending on application, refer to device data sheet. If any vias are implemented, refer to their locations shown on this view. It is recommended that vias under paste be filled, plugged or tented.

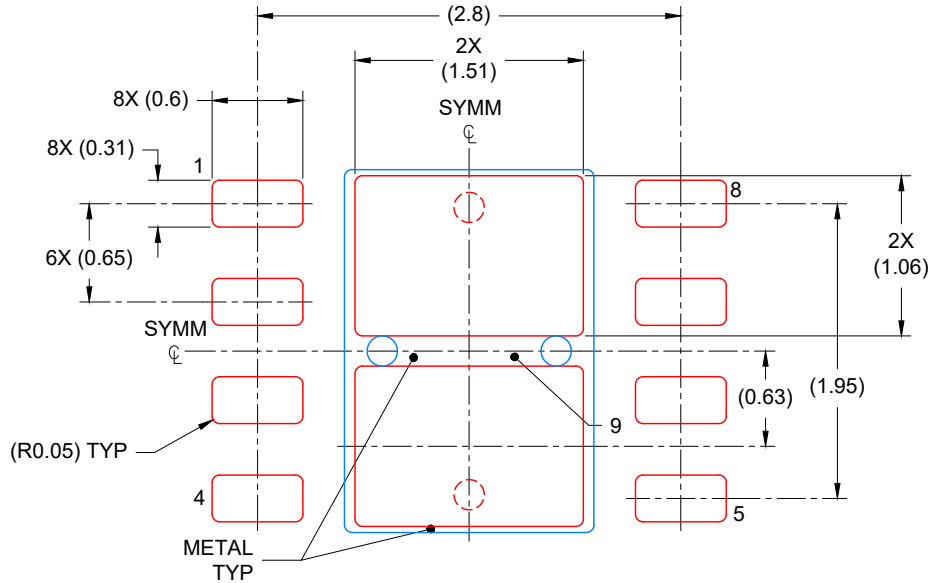

SOLDER PASTE EXAMPLE  
 BASED ON 0.125 mm THICK STENCIL

EXPOSED PAD  
 81% PRINTED COVERAGE BY AREA  
 SCALE: 20X

4225036/A 06/2019

NOTES: (continued)

6. Laser cutting apertures with trapezoidal walls and rounded corners may offer better paste release. IPC-7525 may have alternate design recommendations.

## IMPORTANT NOTICE AND DISCLAIMER

TI PROVIDES TECHNICAL AND RELIABILITY DATA (INCLUDING DATA SHEETS), DESIGN RESOURCES (INCLUDING REFERENCE DESIGNS), APPLICATION OR OTHER DESIGN ADVICE, WEB TOOLS, SAFETY INFORMATION, AND OTHER RESOURCES "AS IS" AND WITH ALL FAULTS, AND DISCLAIMS ALL WARRANTIES, EXPRESS AND IMPLIED, INCLUDING WITHOUT LIMITATION ANY IMPLIED WARRANTIES OF MERCHANTABILITY, FITNESS FOR A PARTICULAR PURPOSE OR NON-INFRINGEMENT OF THIRD PARTY INTELLECTUAL PROPERTY RIGHTS.

These resources are intended for skilled developers designing with TI products. You are solely responsible for (1) selecting the appropriate TI products for your application, (2) designing, validating and testing your application, and (3) ensuring your application meets applicable standards, and any other safety, security, regulatory or other requirements.

These resources are subject to change without notice. TI grants you permission to use these resources only for development of an application that uses the TI products described in the resource. Other reproduction and display of these resources is prohibited. No license is granted to any other TI intellectual property right or to any third party intellectual property right. TI disclaims responsibility for, and you will fully indemnify TI and its representatives against, any claims, damages, costs, losses, and liabilities arising out of your use of these resources.

TI's products are provided subject to [TI's Terms of Sale](#) or other applicable terms available either on [ti.com](https://www.ti.com) or provided in conjunction with such TI products. TI's provision of these resources does not expand or otherwise alter TI's applicable warranties or warranty disclaimers for TI products.

TI objects to and rejects any additional or different terms you may have proposed.

Mailing Address: Texas Instruments, Post Office Box 655303, Dallas, Texas 75265  
Copyright © 2024, Texas Instruments Incorporated