

SN74AHC1G126 Single Bus Buffer Gate With 3-State Output

1 Features

- Operating range of 2V to 5.5V
- Max t_{pd} of 6ns at 5V
- Low power consumption, 10 μ A max I_{CC}
- ± 8 mA output drive at 5V
- Latch-up performance exceeds 250mA per JESD 17

2 Applications

- Projectors
- TVs
- Servers
- Motor Controls
- Patient Monitoring
- Electronic Points of Sale

3 Description

The SN74AHC1G126 device is a single bus buffer gate/line driver with 3-state output. The output is disabled when the output-enable (OE) input is low. When OE is high, true data is passed from the A input to the Y output.

Package Information

PART NUMBER	PACKAGE ⁽¹⁾	PACKAGE SIZE ⁽²⁾	BODY SIZE ⁽³⁾
SN74AHC1G126	DBV (SOT-23, 5)	2.9mm x 2.8mm	2.9mm x 1.6mm
	DCK (SC-70, 5)	2mm x 2.1mm	2mm x 1.25mm
	DRL (SOT-553, 5)	1.6mm x 1.6mm	1.6mm x 1.2mm

- (1) For all available packages, see the orderable addendum at the end of the data sheet.
- (2) The package size (length x width) is a nominal value and includes pins, where applicable.
- (3) The body size (length x width) is a nominal value and does not include pins.

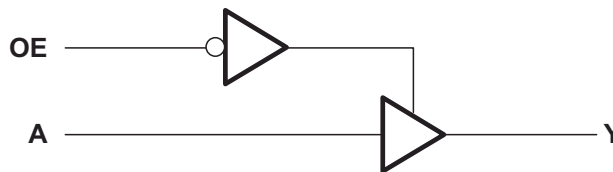

Simplified Schematic

Table of Contents

1 Features	1	7.3 Feature Description.....	9
2 Applications	1	7.4 Device Functional Modes.....	9
3 Description	1	8 Application and Implementation	10
4 Pin Configuration and Functions	3	8.1 Application Information.....	10
5 Specifications	4	8.2 Typical Application.....	10
5.1 Absolute Maximum Ratings.....	4	8.3 Power Supply Recommendations.....	11
5.2 ESD Ratings.....	4	8.4 Layout.....	11
5.3 Recommended Operating Conditions.....	4	9 Device and Documentation Support	12
5.4 Thermal Information.....	5	9.1 Documentation Support (Analog).....	12
5.5 Electrical Characteristics.....	5	9.2 Receiving Notification of Documentation Updates....	12
5.6 Switching Characteristics, $V_{CC} = 3.3\text{ V} \pm 0.3\text{ V}$	6	9.3 Support Resources.....	12
5.7 Switching Characteristics, $V_{CC} = 5\text{ V} \pm 0.5\text{ V}$	6	9.4 Trademarks.....	12
5.8 Operating Characteristics.....	6	9.5 Electrostatic Discharge Caution.....	12
5.9 Typical Characteristics.....	7	9.6 Glossary.....	12
6 Parameter Measurement Information	8	10 Revision History	12
7 Detailed Description	9	11 Mechanical, Packaging, and Orderable Information	13
7.1 Overview.....	9		
7.2 Functional Block Diagram.....	9		

4 Pin Configuration and Functions

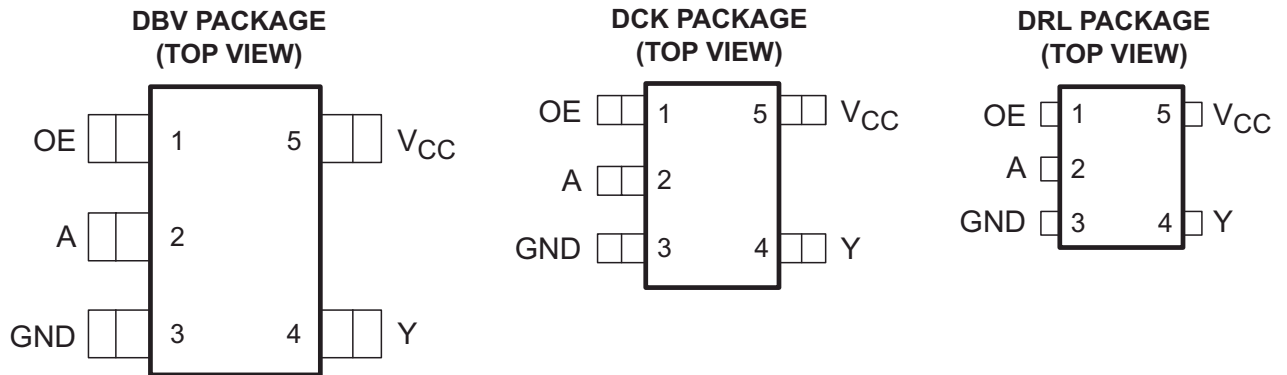

See mechanical drawings for dimensions.

Table 4-1. Pin Functions

PIN		TYPE ⁽¹⁾	DESCRIPTION
NO.	NAME		
1	OE	I	Output Enable
2	A	I	Input A
3	GND	—	Ground Pin
4	Y	O	Output Y
5	V _{CC}	—	Power Pin

(1) Signal Types: I = Input, O = Output, I/O = Input or Output

5 Specifications

5.1 Absolute Maximum Ratings

over operating free-air temperature range (unless otherwise noted)⁽¹⁾

		MIN	MAX	UNIT
V _{CC}	Supply voltage range	-0.5	7	V
V _I ⁽²⁾	Input voltage range	-0.5	7	V
V _O ⁽²⁾	Output voltage range	-0.5	V _{CC} + 0.5	V
I _{IK}	Input clamp current	(V _I < 0)	-20	mA
I _{OK}	Output clamp current	(V _O < 0 or V _O > V _{CC})	±20	mA
I _O	Continuous output current	(V _O = 0 to V _{CC})	±25	mA
	Continuous channel current through V _{CC} or GND		±50	mA
T _{stg}	Storage temperature range	-65	150	°C
T _J	Junction Temperature		150	°C

- (1) Stresses beyond those listed under *Absolute Maximum Ratings* may cause permanent damage to the device. These are stress ratings only, and functional operation of the device at these or any other conditions beyond those indicated under [Section 5.3](#) is not implied. Exposure to absolute-maximum-rated conditions for extended periods may affect device reliability.
- (2) The input and output voltage ratings may be exceeded if the input and output current ratings are observed.

5.2 ESD Ratings

		VALUE	UNIT
V _(ESD)	Electrostatic discharge		
	Human body model (HBM), per ANSI/ESDA/JEDEC JS-001, all pins ⁽¹⁾	±1500	V
	Charged device model (CDM), per JEDEC specification JESD22-C101, all pins ⁽²⁾	±1000	

- (1) JEDEC document JEP155 states that 500-V HBM allows safe manufacturing with a standard ESD control process.
- (2) JEDEC document JEP157 states that 250-V CDM allows safe manufacturing with a standard ESD control process.

5.3 Recommended Operating Conditions

over operating free-air temperature range (unless otherwise noted)⁽¹⁾

		MIN	MAX	UNIT
V _{CC}	Supply voltage	2	5.5	V
V _{IH}	High-level input voltage	V _{CC} = 2 V	1.5	V
		V _{CC} = 3 V	2.1	
		V _{CC} = 5.5 V	3.85	
V _{IL}	Low-level input voltage	V _{CC} = 2 V	0.5	V
		V _{CC} = 3 V	0.9	
		V _{CC} = 5.5 V	1.65	
V _I	Input voltage	0	5.5	V
V _O	Output voltage	0	V _{CC}	V
I _{OH}	High-level output current	V _{CC} = 2 V	-50	μA
		V _{CC} = 3.3 V ± 0.3 V	-4	mA
		V _{CC} = 5 V ± 0.5 V	-8	
I _{OL}	Low-level output current	V _{CC} = 2 V	50	μA
		V _{CC} = 3.3 V ± 0.3 V	4	mA
		V _{CC} = 5 V ± 0.5 V	8	
Δt/Δv	Input transition rise or fall rate	V _{CC} = 3.3 V ± 0.3 V	100	ns/V
		V _{CC} = 5 V ± 0.5 V	20	

over operating free-air temperature range (unless otherwise noted)⁽¹⁾

		MIN	MAX	UNIT
T _A	Operating free-air temperature	-40	125	°C

(1) All unused inputs of the device must be held at V_{CC} or GND to ensure proper device operation. Refer to the TI application report, *Implications of Slow or Floating CMOS Inputs (SCBA004)*.

5.4 Thermal Information

THERMAL METRIC ⁽¹⁾		SN74AHC1G126			UNIT
		DBV(SOT-23)	DCK(SC-70)	DRL(SOT-553)	
		5 PINS			
R _{θJA}	Junction-to-ambient thermal resistance	278	289.2	328.7	°C/W
R _{θJC(top)}	Junction-to-case (top) thermal resistance	180.5	205.8	105.1	
R _{θJB}	Junction-to-board thermal resistance	184.4	176.2	150.3	
ψ _{JT}	Junction-to-top characterization parameter	115.4	117.6	6.9	
ψ _{JB}	Junction-to-board characterization parameter	183.4	175.1	148.4	
R _{θJC(bot)}	Junction-to-case (bot) thermal resistance	N/A	N/A	N/A	

(1) For more information about traditional and new thermal metrics, see the *IC Package Thermal Metrics* application report (SPRA953).

5.5 Electrical Characteristics

over recommended operating free-air temperature range (unless otherwise noted)

PARAMETER	TEST CONDITIONS	V _{CC}	T _A = 25°C			-40°C to 85°C		-40°C to 125°C		UNIT
			MIN	TYP	MAX	MIN	MAX	MIN	MAX	
V _{OH}	High level output voltage	I _{OH} = -50 μA	2 V	1.9	2	1.9	1.9	V		
			3 V	2.9	3	2.9	2.9			
			4.5 V	4.4	4.5	4.4	4.4			
	I _{OH} = -4 mA	3 V	2.58		2.48	2.48				
	I _{OH} = -8 mA	4.5 V	3.94		3.8	3.8				
V _{OL}	Low level output voltage	I _{OL} = 50 μA	2 V		0.1	0.1	0.1	V		
			3 V		0.1	0.1	0.1			
			4.5 V		0.1	0.1	0.1			
	I _{OL} = 4 mA	3 V		0.36	0.44	0.44				
	I _{OL} = 8 mA	4.5 V		0.36	0.44	0.44				
I _I	Input leakage current	V _I = 5.5 V or GND	0 V to 5.5 V		±0.1		±1	±1	μA	
I _{oz}	Off-State (High-Impedance State) Output Current (of a 3-State Output)	V _I = V _{CC} or GND	5.5 V		±0.25		±2.5	±2.5	μA	
I _{CC}	Supply current	V _I = V _{CC} or GND, I _O = 0	5.5 V		1		10	10	μA	
C _i	Input capacitance	V _I = V _{CC} or GND	5 V		4	10	10	10	pF	
C _o	Output capacitance	V _O = V _{CC} or GND	5 V		10				pF	

5.6 Switching Characteristics, $V_{CC} = 3.3\text{ V} \pm 0.3\text{ V}$

over recommended operating free-air temperature range (unless otherwise noted) (see [Load Circuit and Voltage Waveforms](#))

PARAMETER	FROM (INPUT)	TO (OUTPUT)	LOAD CAPACITANCE	$T_A = 25^\circ\text{C}$			$-40^\circ\text{C to } 85^\circ\text{C}$		$-40^\circ\text{C to } 125^\circ\text{C}$		UNIT
				MIN	TYP	MAX	MIN	MAX	MIN	MAX	
t_{PLH}	A	Y	$C_L = 15\text{ pF}$		5.6	8	1	9.5	1	10	ns
t_{PHL}					5.6	8	1	9.5	1	10	
t_{PZH}	OE	Y	$C_L = 15\text{ pF}$		5.4	8	1	9.5	1	10	ns
t_{PZL}					5.4	8	1	9.5	1	10	
t_{PHZ}	OE	Y	$C_L = 15\text{ pF}$		7	9.7	1	11.5	1	12.5	ns
t_{PLZ}					7	9.7	1	11.5	1	12.5	
t_{PLH}	A	Y	$C_L = 50\text{ pF}$		8.1	11.5	1	13	1	14	ns
t_{PHL}					8.1	11.5	1	13	1	14	
t_{PZH}	OE	Y	$C_L = 50\text{ pF}$		7.9	11.5	1	13	1	14	ns
t_{PZL}					7.9	11.5	1	13	1	14	
t_{PHZ}	OE	Y	$C_L = 50\text{ pF}$		9.5	13.2	1	15	1	16	ns
t_{PLZ}					9.5	13.2	1	15	1	16	

5.7 Switching Characteristics, $V_{CC} = 5\text{ V} \pm 0.5\text{ V}$

over recommended operating free-air temperature range (unless otherwise noted) (see [Load Circuit and Voltage Waveforms](#))

PARAMETER	FROM (INPUT)	TO (OUTPUT)	LOAD CAPACITANCE	$T_A = 25^\circ\text{C}$			$-40^\circ\text{C to } 85^\circ\text{C}$		$-40^\circ\text{C to } 125^\circ\text{C}$		UNIT
				MIN	TYP	MAX	MIN	MAX	MIN	MAX	
t_{PLH}	A	Y	$C_L = 15\text{ pF}$		3.8	5.5	1	6.5	1	7	ns
t_{PHL}					3.8	5.5	1	6.5	1	7	
t_{PZH}	OE	Y	$C_L = 15\text{ pF}$		3.6	5.1	1	6	1	6.5	ns
t_{PZL}					3.6	5.1	1	6	1	6.5	
t_{PHZ}	OE	Y	$C_L = 15\text{ pF}$		4.6	6.8	1	8	1	8.5	ns
t_{PLZ}					4.6	6.8	1	8	1	8.5	
t_{PLH}	A	Y	$C_L = 50\text{ pF}$		5.3	7.5	1	8.5	1	9.5	ns
t_{PHL}					5.3	7.5	1	8.5	1	9.5	
t_{PZH}	OE	Y	$C_L = 50\text{ pF}$		5.1	7.1	1	8	1	9	ns
t_{PZL}					5.1	7.1	1	8	1	9	
t_{PHZ}	OE	Y	$C_L = 50\text{ pF}$		6.1	8.8	1	10	1	11	ns
t_{PLZ}					6.1	8.8	1	10	1	11	

5.8 Operating Characteristics

$V_{CC} = 5\text{ V}$, $T_A = 25^\circ\text{C}$

PARAMETER	TEST CONDITIONS	TYP	UNIT
C_{pd} Power dissipation capacitance	No load, $f = 1\text{ MHz}$	14	pF

5.9 Typical Characteristics

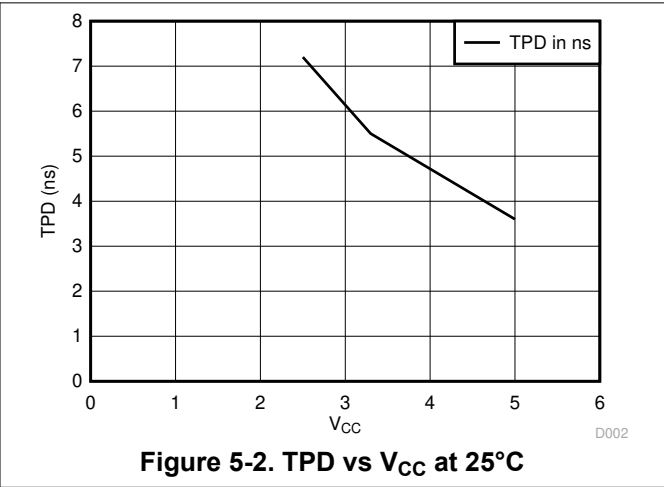
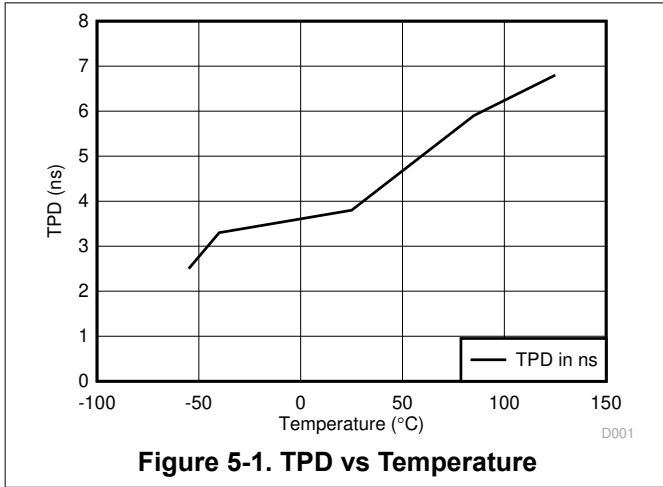

6 Parameter Measurement Information

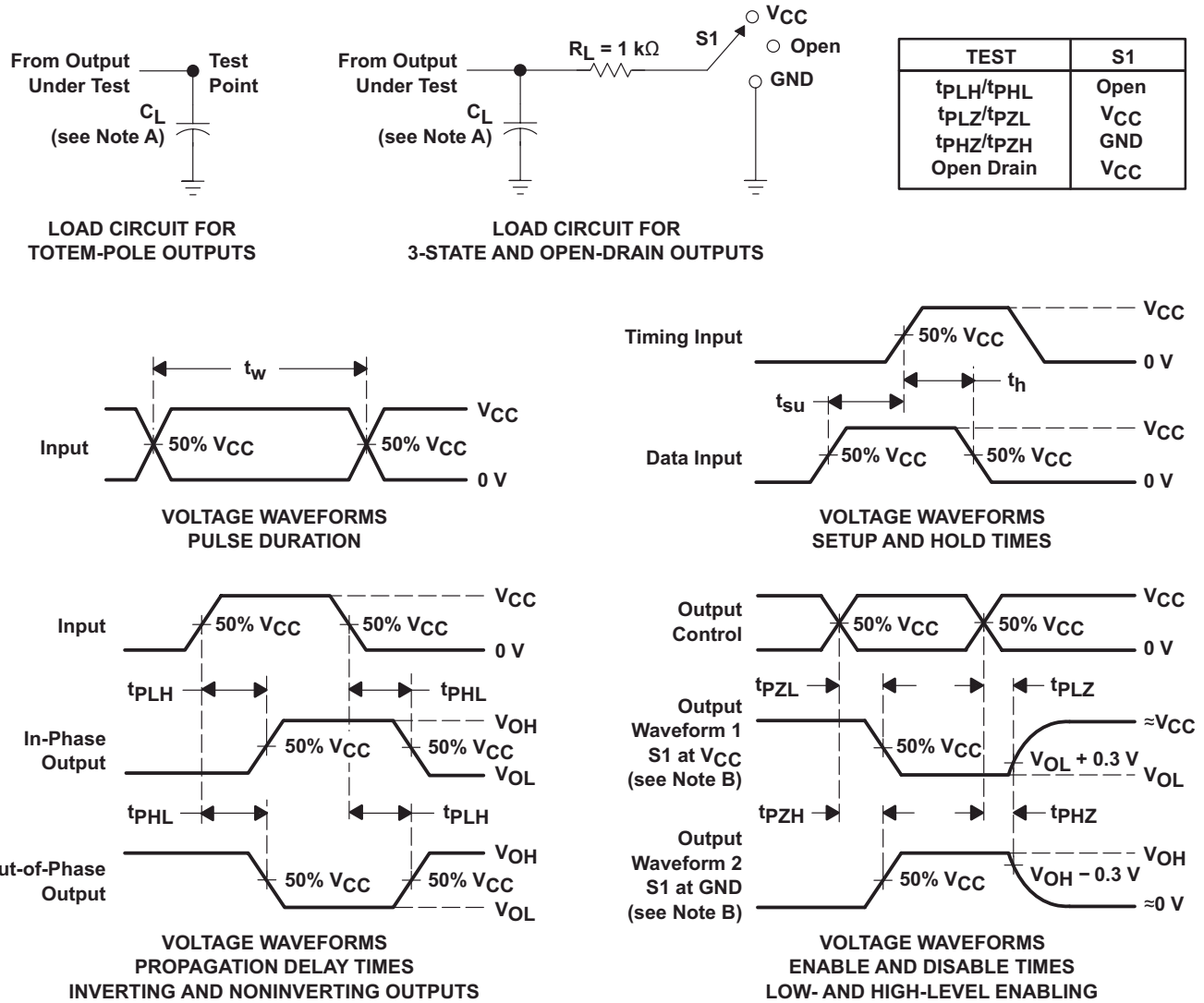

- NOTES: A. C_L includes probe and jig capacitance.
 B. Waveform 1 is for an output with internal conditions such that the output is low except when disabled by the output control. Waveform 2 is for an output with internal conditions such that the output is high except when disabled by the output control.
 C. All input pulses are supplied by generators having the following characteristics: PRR $\leq 1\text{ MHz}$, $Z_O = 50\ \Omega$, $t_r \leq 3\text{ ns}$, $t_f \leq 3\text{ ns}$.
 D. The outputs are measured one at a time with one input transition per measurement.
 E. All parameters and waveforms are not applicable to all devices.

Figure 6-1. Load Circuit and Voltage Waveforms

7 Detailed Description

7.1 Overview

The SN74AHC1G126 device is a single bus buffer gate/line driver with 3-state output. The output is disabled when the output-enable (OE) input is low. When OE is high, true data is passed from the A input to the Y output.

To ensure the high-impedance state during power up or power down, OE should be tied to GND through a pulldown resistor; the minimum value of the resistor is determined by the current-sourcing capability of the driver.

7.2 Functional Block Diagram

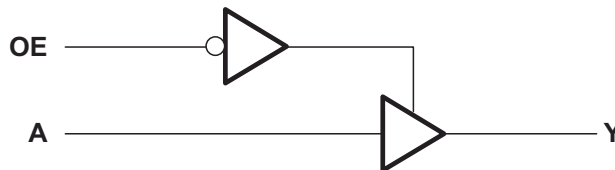

Figure 7-1. Logic Diagram (Positive Logic)

7.3 Feature Description

- Wide operating voltage range
 - Operates from 2 V to 5.5 V
- Allows down-voltage translation
 - Inputs accept voltages to 5.5 V

7.4 Device Functional Modes

Table 7-1. Function Table

INPUTS ⁽¹⁾		OUTPUT ⁽²⁾
OE	A	Y
H	H	H
H	L	L
L	X	Z

- (1) H = High Voltage Level, L = Low Voltage Level, X = Don't Care
- (2) H = Driving High, L = Driving Low, Z = High Impedance State

8 Application and Implementation

Note

Information in the following applications sections is not part of the TI component specification, and TI does not warrant its accuracy or completeness. TI's customers are responsible for determining suitability of components for their purposes, as well as validating and testing their design implementation to confirm system functionality.

8.1 Application Information

The SN74AHC1G126 is a low-drive CMOS device that can be used for a multitude of bus interface type applications where output ringing is a concern. The low drive and slow edge rates will minimize overshoot and undershoot on the outputs. The inputs are 5.5-V tolerant at any valid V_{CC} , making it ideal for translating down to V_{CC} .

8.2 Typical Application

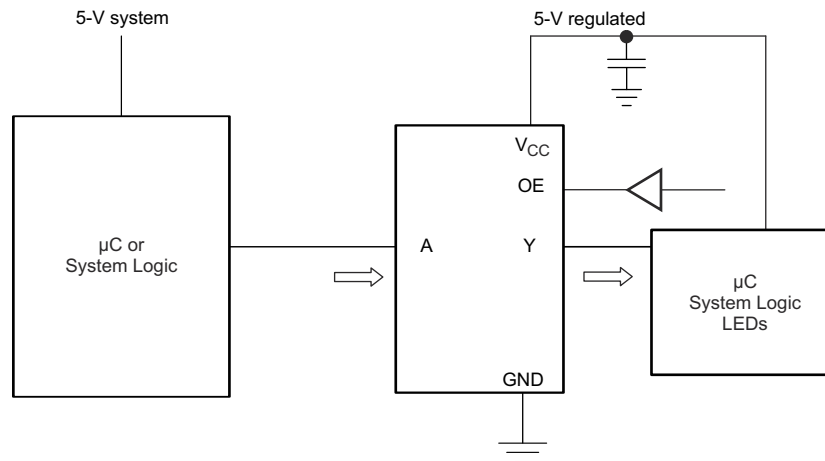

Figure 8-1. Typical Application Schematic

8.2.1 Design Requirements

This device uses CMOS technology and has balanced output drive. Care should be taken to avoid bus contention because it can drive currents that would exceed maximum limits. The high drive will also create fast edges into light loads, so routing and load conditions should be considered to prevent ringing.

8.2.2 Detailed Design Procedure

- Recommended Input Conditions
 - For rise time and fall time specifications, see $\Delta t/\Delta V$ in the [Section 5.3](#) table.
 - For specified High and low levels, see V_{IH} and V_{IL} in the [Section 5.3](#) table.
- Recommend Output Conditions
 - Load currents should not exceed 25 mA per output and 50 mA total for the part.
 - Outputs should not be pulled above V_{CC} .

8.2.3 Application Curves

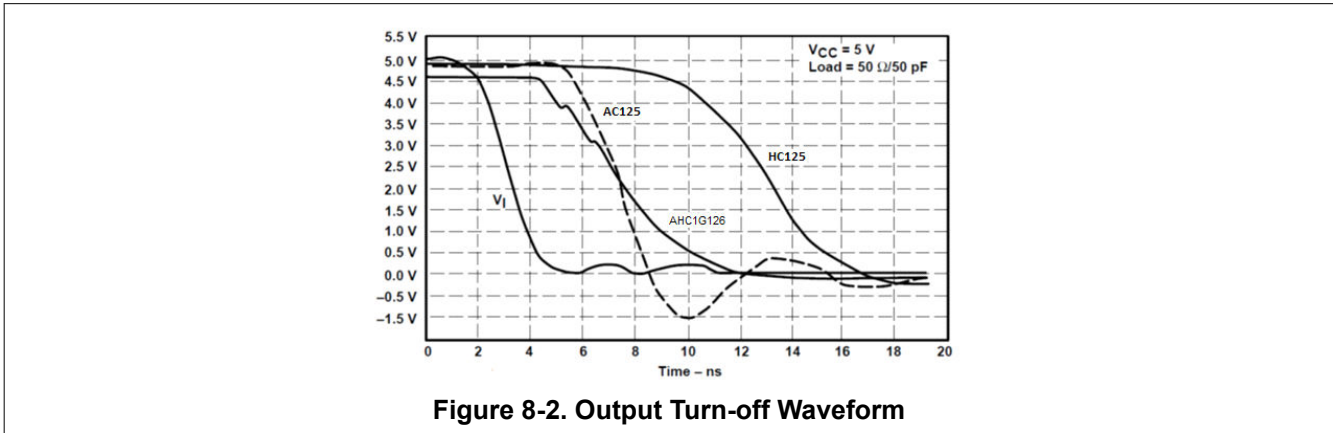

8.3 Power Supply Recommendations

The power supply can be any voltage between the MIN and MAX supply voltage rating located in the [Section 5.3](#) table.

Each V_{CC} pin should have a good bypass capacitor to prevent power disturbance. For devices with a single supply, 0.1 μF is recommended. If there are multiple V_{CC} pins, 0.01 μF or 0.022 μF is recommended for each power pin. It is acceptable to parallel multiple bypass caps to reject different frequencies of noise. A 0.1 μF and 1 μF are commonly used in parallel. The bypass capacitor should be installed as close to the power pin as possible for best results.

8.4 Layout

8.4.1 Layout Guidelines

When using multiple bit logic devices, inputs should not float. In many cases, functions or parts of functions of digital logic devices are unused. Some examples are when only two inputs of a triple-input AND gate are used, or when only 3 of the 4-buffer gates are used. Such input pins should not be left unconnected because the undefined voltages at the outside connections result in undefined operational states.

Specified in [Figure 8-3](#) are rules that must be observed under all circumstances. All unused inputs of digital logic devices must be connected to a high or low bias to prevent them from floating. The logic level that should be applied to any particular unused input depends on the function of the device. Generally they will be tied to GND or V_{CC} , whichever makes more sense or is more convenient. It is acceptable to float outputs unless the part is a transceiver. If the transceiver has an output enable pin, it will disable the outputs section of the part when asserted. This will not disable the input section of the I/Os so they also cannot float when disabled.

8.4.2 Layout Example

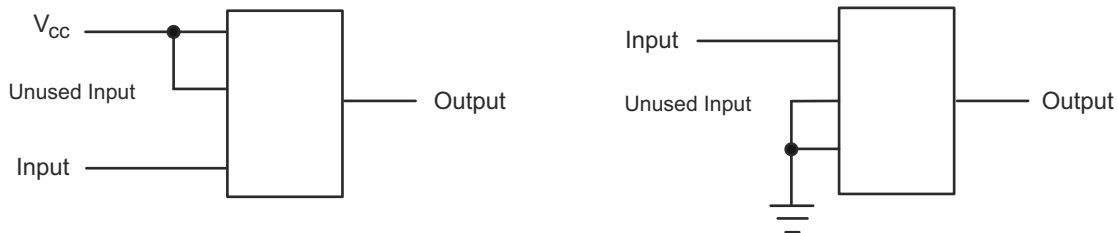

Figure 8-3. Layout Diagram

9 Device and Documentation Support

9.1 Documentation Support (Analog)

9.2 Receiving Notification of Documentation Updates

To receive notification of documentation updates, navigate to the device product folder on ti.com. Click on *Notifications* to register and receive a weekly digest of any product information that has changed. For change details, review the revision history included in any revised document.

9.2.1 Related Documentation

For related documentation, see the following:

- Texas Instruments, [CMOS Power Consumption and Cpd Calculation application note](#)
- Texas Instruments, [Designing With Logic application note](#)
- Texas Instruments, [Thermal Characteristics of Standard Linear and Logic \(SLL\) Packages and Devices application note](#)
- Texas Instruments, [Implications of Slow or Floating CMOS Inputs application note](#)

9.3 Support Resources

[TI E2E™ support forums](#) are an engineer's go-to source for fast, verified answers and design help — straight from the experts. Search existing answers or ask your own question to get the quick design help you need.

Linked content is provided "AS IS" by the respective contributors. They do not constitute TI specifications and do not necessarily reflect TI's views; see TI's [Terms of Use](#).

9.4 Trademarks

TI E2E™ is a trademark of Texas Instruments.

All trademarks are the property of their respective owners.

9.5 Electrostatic Discharge Caution



This integrated circuit can be damaged by ESD. Texas Instruments recommends that all integrated circuits be handled with appropriate precautions. Failure to observe proper handling and installation procedures can cause damage.

ESD damage can range from subtle performance degradation to complete device failure. Precision integrated circuits may be more susceptible to damage because very small parametric changes could cause the device not to meet its published specifications.

9.6 Glossary

[TI Glossary](#) This glossary lists and explains terms, acronyms, and definitions.

10 Revision History

Changes from Revision L (October 2023) to Revision M (February 2024)	Page
• Updated thermal values for DBV package from R θ JA = 231.3 to 278, R θ JC(top) = 119.9 to 180.5, R θ JB = 60.6 to 184.4, Ψ JT = 17.8 to 115.4, Ψ JB = 60.1 to 183.4, R θ JC(bot) = N/A, all values in °C/W	5

Changes from Revision K (December 2014) to Revision L (October 2023)	Page
• Updated the numbering format for tables, figures, and cross-references throughout the document.....	1
• Updated thermal values for DCK package from R θ JA = 287.6 to 289.2, R θ JC(top) = 97.7 to 205.8, R θ JB = 65 to 176.2, Ψ JT = 2 to 117.6, Ψ JB = 64.2 to 175.1, R θ JC(bot) = N/A, all values in °C/W.....	5

11 Mechanical, Packaging, and Orderable Information

The following pages include mechanical, packaging, and orderable information. This information is the most current data available for the designated devices. This data is subject to change without notice and revision of this document. For browser-based versions of this data sheet, refer to the left-hand navigation.

PACKAGING INFORMATION

Orderable Device	Status (1)	Package Type	Package Drawing	Pins	Package Qty	Eco Plan (2)	Lead finish/ Ball material (6)	MSL Peak Temp (3)	Op Temp (°C)	Device Marking (4/5)	Samples
74AHC1G126DBVTG4	ACTIVE	SOT-23	DBV	5	250	RoHS & Green	NIPDAU	Level-1-260C-UNLIM	-40 to 125	A26G	Samples
74AHC1G126DCKRE4	ACTIVE	SC70	DCK	5	3000	RoHS & Green	NIPDAU	Level-1-260C-UNLIM	-40 to 125	AN3	Samples
74AHC1G126DCKTE4	ACTIVE	SC70	DCK	5	250	RoHS & Green	NIPDAU	Level-1-260C-UNLIM	-40 to 125	AN3	Samples
74AHC1G126DCKTG4	ACTIVE	SC70	DCK	5	250	RoHS & Green	NIPDAU	Level-1-260C-UNLIM	-40 to 125	AN3	Samples
SN74AHC1G126DBVR	ACTIVE	SOT-23	DBV	5	3000	RoHS & Green	SN	Level-1-260C-UNLIM	-40 to 125	(39LH, 3BZF, A263, A26G, A26J, A26S)	Samples
SN74AHC1G126DBVT	OBSOLETE	SOT-23	DBV	5		TBD	Call TI	Call TI	-40 to 125	(A263, A26G, A26J, A26S)	
SN74AHC1G126DCKR	ACTIVE	SC70	DCK	5	3000	RoHS & Green	SN	Level-1-260C-UNLIM	-40 to 125	(1RE, AN3, ANG, ANJ, ANS)	Samples
SN74AHC1G126DCKT	OBSOLETE	SC70	DCK	5		TBD	Call TI	Call TI	-40 to 125	(AN3, ANG, ANJ, ANS)	
SN74AHC1G126DRLR	ACTIVE	SOT-5X3	DRL	5	4000	RoHS & Green	NIPDAUAG	Level-1-260C-UNLIM	-40 to 125	ANS	Samples

(1) The marketing status values are defined as follows:

ACTIVE: Product device recommended for new designs.

LIFEBUY: TI has announced that the device will be discontinued, and a lifetime-buy period is in effect.

NRND: Not recommended for new designs. Device is in production to support existing customers, but TI does not recommend using this part in a new design.

PREVIEW: Device has been announced but is not in production. Samples may or may not be available.

OBSOLETE: TI has discontinued the production of the device.

(2) **RoHS:** TI defines "RoHS" to mean semiconductor products that are compliant with the current EU RoHS requirements for all 10 RoHS substances, including the requirement that RoHS substance do not exceed 0.1% by weight in homogeneous materials. Where designed to be soldered at high temperatures, "RoHS" products are suitable for use in specified lead-free processes. TI may reference these types of products as "Pb-Free".

RoHS Exempt: TI defines "RoHS Exempt" to mean products that contain lead but are compliant with EU RoHS pursuant to a specific EU RoHS exemption.

Green: TI defines "Green" to mean the content of Chlorine (Cl) and Bromine (Br) based flame retardants meet JS709B low halogen requirements of <=1000ppm threshold. Antimony trioxide based flame retardants must also meet the <=1000ppm threshold requirement.

(3) MSL, Peak Temp. - The Moisture Sensitivity Level rating according to the JEDEC industry standard classifications, and peak solder temperature.

- (4) There may be additional marking, which relates to the logo, the lot trace code information, or the environmental category on the device.
- (5) Multiple Device Markings will be inside parentheses. Only one Device Marking contained in parentheses and separated by a "~" will appear on a device. If a line is indented then it is a continuation of the previous line and the two combined represent the entire Device Marking for that device.
- (6) Lead finish/Ball material - Orderable Devices may have multiple material finish options. Finish options are separated by a vertical ruled line. Lead finish/Ball material values may wrap to two lines if the finish value exceeds the maximum column width.

Important Information and Disclaimer:The information provided on this page represents TI's knowledge and belief as of the date that it is provided. TI bases its knowledge and belief on information provided by third parties, and makes no representation or warranty as to the accuracy of such information. Efforts are underway to better integrate information from third parties. TI has taken and continues to take reasonable steps to provide representative and accurate information but may not have conducted destructive testing or chemical analysis on incoming materials and chemicals. TI and TI suppliers consider certain information to be proprietary, and thus CAS numbers and other limited information may not be available for release.

In no event shall TI's liability arising out of such information exceed the total purchase price of the TI part(s) at issue in this document sold by TI to Customer on an annual basis.

OTHER QUALIFIED VERSIONS OF SN74AHC1G126 :

- Automotive : [SN74AHC1G126-Q1](#)
- Enhanced Product : [SN74AHC1G126-EP](#)

NOTE: Qualified Version Definitions:

- Automotive - Q100 devices qualified for high-reliability automotive applications targeting zero defects
- Enhanced Product - Supports Defense, Aerospace and Medical Applications

TAPE AND REEL INFORMATION

QUADRANT ASSIGNMENTS FOR PIN 1 ORIENTATION IN TAPE

*All dimensions are nominal

Device	Package Type	Package Drawing	Pins	SPQ	Reel Diameter (mm)	Reel Width W1 (mm)	A0 (mm)	B0 (mm)	K0 (mm)	P1 (mm)	W (mm)	Pin1 Quadrant
74AHC1G126DBVTG4	SOT-23	DBV	5	250	178.0	9.0	3.23	3.17	1.37	4.0	8.0	Q3
74AHC1G126DCKTG4	SC70	DCK	5	250	178.0	9.2	2.4	2.4	1.22	4.0	8.0	Q3
SN74AHC1G126DBVR	SOT-23	DBV	5	3000	180.0	8.4	3.2	3.2	1.4	4.0	8.0	Q3
SN74AHC1G126DCKR	SC70	DCK	5	3000	178.0	9.0	2.4	2.5	1.2	4.0	8.0	Q3
SN74AHC1G126DCKR	SC70	DCK	5	3000	180.0	8.4	2.3	2.5	1.2	4.0	8.0	Q3
SN74AHC1G126DRLR	SOT-5X3	DRL	5	4000	180.0	8.4	1.98	1.78	0.69	4.0	8.0	Q3

TAPE AND REEL BOX DIMENSIONS

*All dimensions are nominal

Device	Package Type	Package Drawing	Pins	SPQ	Length (mm)	Width (mm)	Height (mm)
74AHC1G126DBVTG4	SOT-23	DBV	5	250	180.0	180.0	18.0
74AHC1G126DCKTG4	SC70	DCK	5	250	180.0	180.0	18.0
SN74AHC1G126DBVR	SOT-23	DBV	5	3000	210.0	185.0	35.0
SN74AHC1G126DCKR	SC70	DCK	5	3000	180.0	180.0	18.0
SN74AHC1G126DCKR	SC70	DCK	5	3000	210.0	185.0	35.0
SN74AHC1G126DRLR	SOT-5X3	DRL	5	4000	202.0	201.0	28.0

EXAMPLE BOARD LAYOUT

DBV0005A

SOT-23 - 1.45 mm max height

SMALL OUTLINE TRANSISTOR



LAND PATTERN EXAMPLE
EXPOSED METAL SHOWN
SCALE:15X



SOLDER MASK DETAILS

4214839/K 08/2024

NOTES: (continued)

- 6. Publication IPC-7351 may have alternate designs.
- 7. Solder mask tolerances between and around signal pads can vary based on board fabrication site.

EXAMPLE STENCIL DESIGN

DBV0005A

SOT-23 - 1.45 mm max height

SMALL OUTLINE TRANSISTOR



SOLDER PASTE EXAMPLE
BASED ON 0.125 mm THICK STENCIL
SCALE:15X

4214839/K 08/2024

NOTES: (continued)

8. Laser cutting apertures with trapezoidal walls and rounded corners may offer better paste release. IPC-7525 may have alternate design recommendations.
9. Board assembly site may have different recommendations for stencil design.

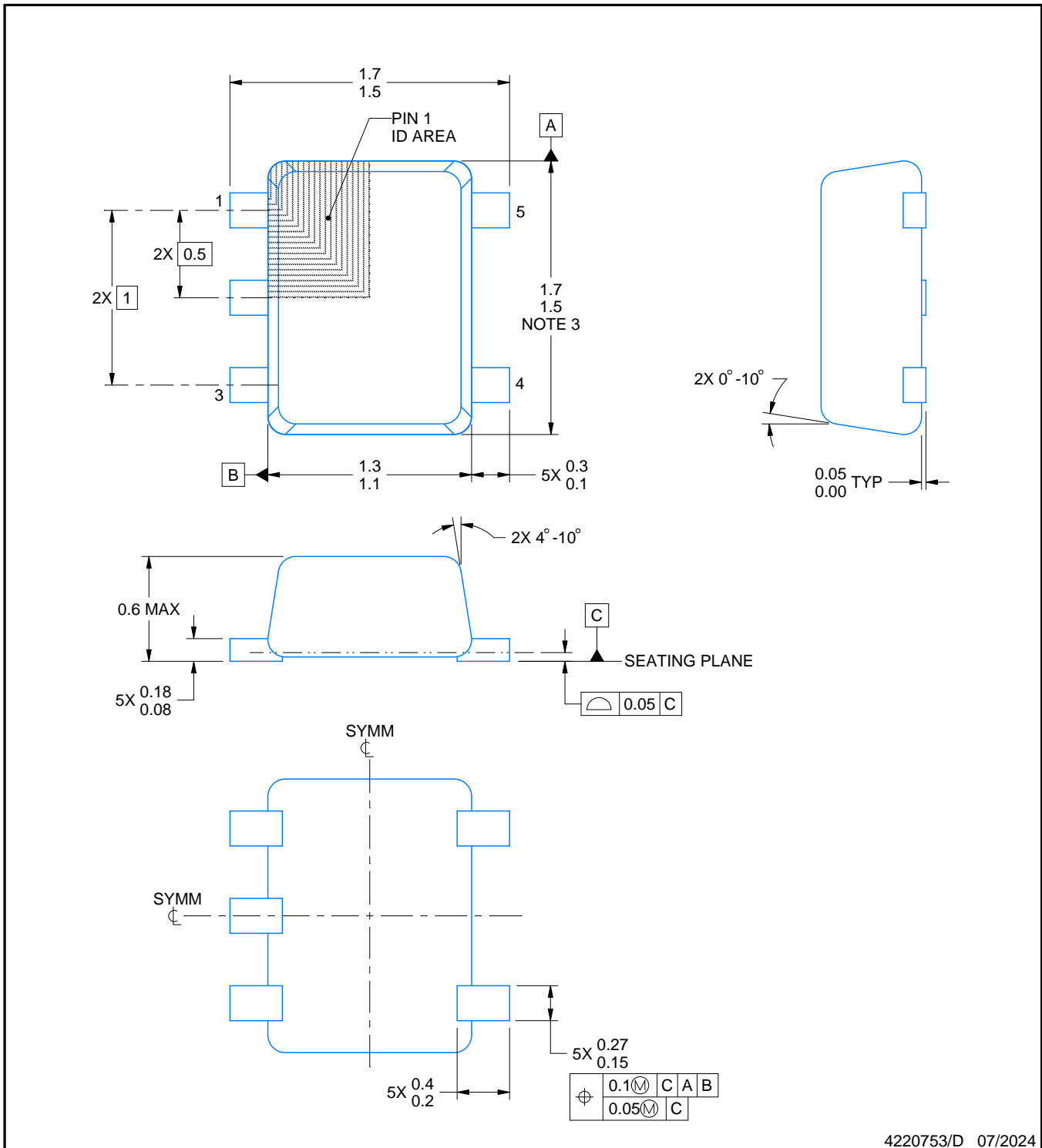
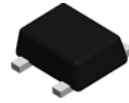

4220753/D 07/2024

NOTES:

1. All linear dimensions are in millimeters. Any dimensions in parenthesis are for reference only. Dimensioning and tolerancing per ASME Y14.5M.
2. This drawing is subject to change without notice.
3. This dimension does not include mold flash, protrusions, or gate burrs. Mold flash, protrusions, or gate burrs shall not exceed 0.15 mm per side.
4. Reference JEDEC registration MO-293 Variation UAAD-1

EXAMPLE BOARD LAYOUT

DRL0005A

SOT - 0.6 mm max height

PLASTIC SMALL OUTLINE

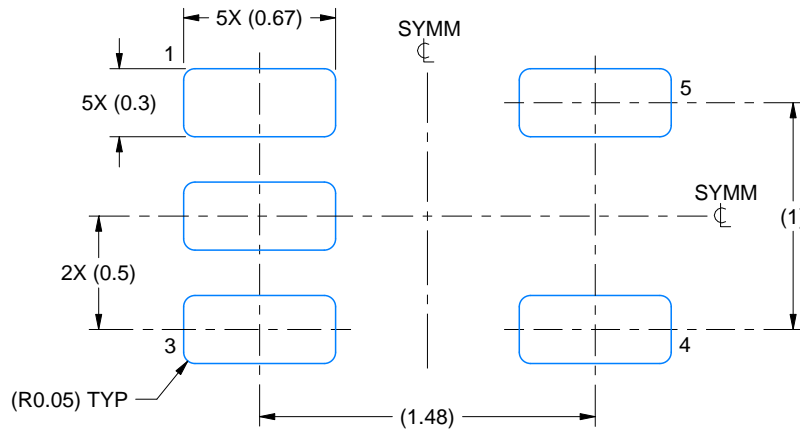

LAND PATTERN EXAMPLE
SCALE:30X

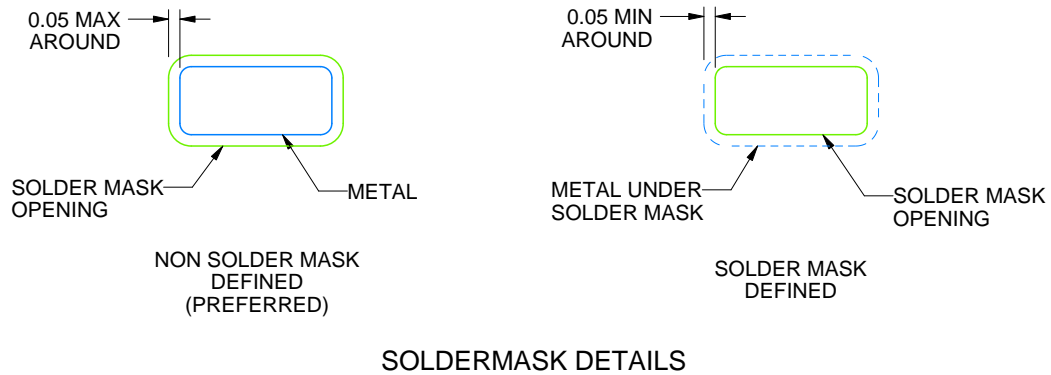

SOLDERMASK DETAILS

4220753/D 07/2024

NOTES: (continued)

- 5. Publication IPC-7351 may have alternate designs.
- 6. Solder mask tolerances between and around signal pads can vary based on board fabrication site.

EXAMPLE STENCIL DESIGN

DRL0005A

SOT - 0.6 mm max height

PLASTIC SMALL OUTLINE

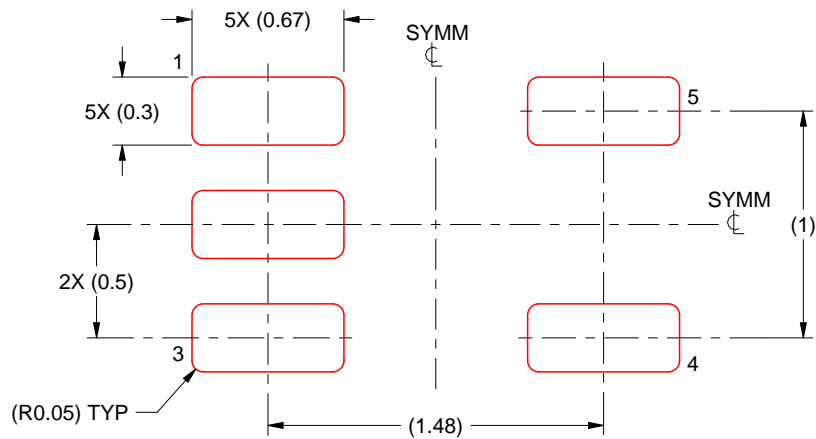

SOLDER PASTE EXAMPLE
BASED ON 0.1 mm THICK STENCIL
SCALE:30X

4220753/D 07/2024

NOTES: (continued)

7. Laser cutting apertures with trapezoidal walls and rounded corners may offer better paste release. IPC-7525 may have alternate design recommendations.
8. Board assembly site may have different recommendations for stencil design.

EXAMPLE BOARD LAYOUT

DCK0005A

SOT - 1.1 max height

SMALL OUTLINE TRANSISTOR

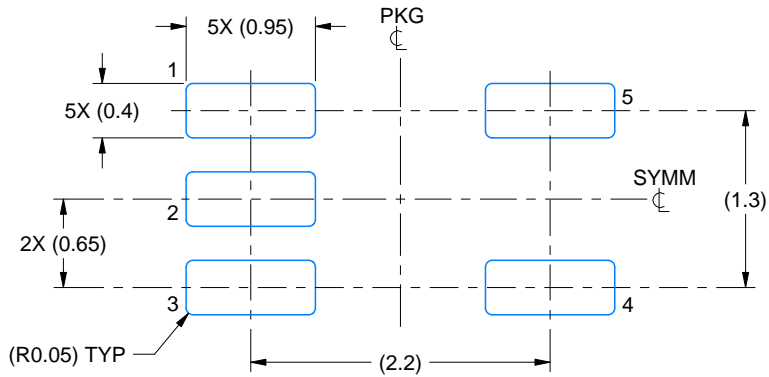

LAND PATTERN EXAMPLE
EXPOSED METAL SHOWN
SCALE:18X

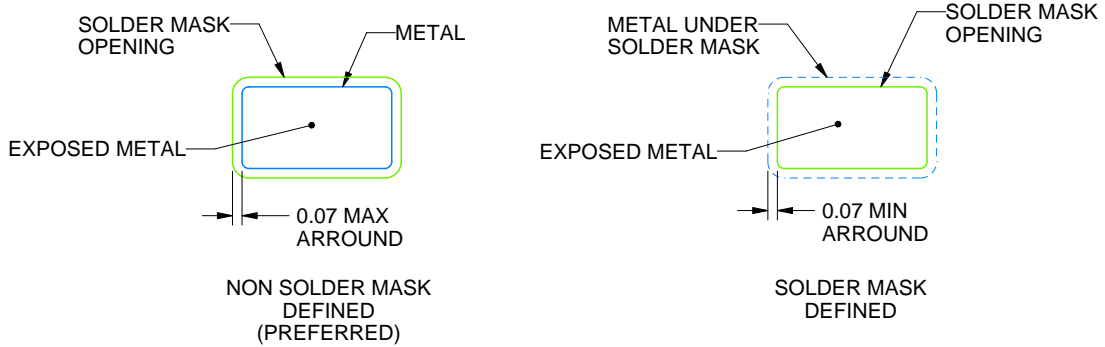

SOLDER MASK DETAILS

4214834/F 08/2024

NOTES: (continued)

- 7. Publication IPC-7351 may have alternate designs.
- 8. Solder mask tolerances between and around signal pads can vary based on board fabrication site.

EXAMPLE STENCIL DESIGN

DCK0005A

SOT - 1.1 max height

SMALL OUTLINE TRANSISTOR

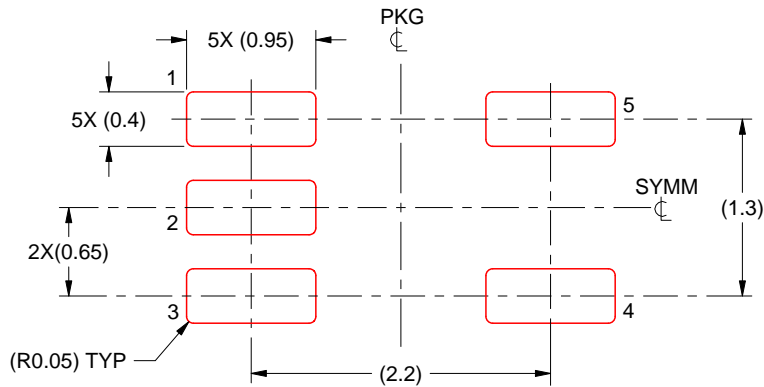

SOLDER PASTE EXAMPLE
BASED ON 0.125 THICK STENCIL
SCALE: 18X

4214834/F 08/2024

NOTES: (continued)

9. Laser cutting apertures with trapezoidal walls and rounded corners may offer better paste release. IPC-7525 may have alternate design recommendations.
10. Board assembly site may have different recommendations for stencil design.

IMPORTANT NOTICE AND DISCLAIMER

TI PROVIDES TECHNICAL AND RELIABILITY DATA (INCLUDING DATA SHEETS), DESIGN RESOURCES (INCLUDING REFERENCE DESIGNS), APPLICATION OR OTHER DESIGN ADVICE, WEB TOOLS, SAFETY INFORMATION, AND OTHER RESOURCES "AS IS" AND WITH ALL FAULTS, AND DISCLAIMS ALL WARRANTIES, EXPRESS AND IMPLIED, INCLUDING WITHOUT LIMITATION ANY IMPLIED WARRANTIES OF MERCHANTABILITY, FITNESS FOR A PARTICULAR PURPOSE OR NON-INFRINGEMENT OF THIRD PARTY INTELLECTUAL PROPERTY RIGHTS.

These resources are intended for skilled developers designing with TI products. You are solely responsible for (1) selecting the appropriate TI products for your application, (2) designing, validating and testing your application, and (3) ensuring your application meets applicable standards, and any other safety, security, regulatory or other requirements.

These resources are subject to change without notice. TI grants you permission to use these resources only for development of an application that uses the TI products described in the resource. Other reproduction and display of these resources is prohibited. No license is granted to any other TI intellectual property right or to any third party intellectual property right. TI disclaims responsibility for, and you will fully indemnify TI and its representatives against, any claims, damages, costs, losses, and liabilities arising out of your use of these resources.

TI's products are provided subject to [TI's Terms of Sale](#) or other applicable terms available either on [ti.com](https://www.ti.com) or provided in conjunction with such TI products. TI's provision of these resources does not expand or otherwise alter TI's applicable warranties or warranty disclaimers for TI products.

TI objects to and rejects any additional or different terms you may have proposed.

Mailing Address: Texas Instruments, Post Office Box 655303, Dallas, Texas 75265
Copyright © 2024, Texas Instruments Incorporated