

TPSM84203, TPSM84205, TPSM84212 1.5-A, 28-V Input, TO-220 Power Module

1 Features

- Complete Integrated Power Solution
- 3-Pin TO-220 Footprint
- Efficiencies up to 95%
- Fixed Output Voltage Options: 3.3 V, 5 V, and 12 V
- 400-kHz Switching Frequency
- Advanced Eco-mode™ Pulse Skip
- Pre-bias Output Start-up
- Over-Current Protection
- Output Over-Voltage Protection
- Thermal Shutdown
- Operating Junction Range: -40°C to $+125^{\circ}\text{C}$
- Operating Ambient Range: -40°C to $+85^{\circ}\text{C}$
- Meets EN55022 Class B Emissions
- Create a Custom Design Using the TPSM84203 with the [WEBENCH® Power Designer](#)

2 Applications

- 12-V, 24-V Distributed Power-Bus Supply
- Industrial White Goods
- Consumer
 - Audio
 - STB, DTV
 - Printer

3 Description

The TPSM842xx power module is an easy-to-use integrated power solution that combines a 1.5-A DC/DC converter with power MOSFETs, an inductor, and passives into a 3-pin, through-hole package. This total power solution requires adding only input and output capacitors and eliminates the loop compensation and magnetics part selection from the design process.

The standard TO-220 pin-out allows a much improved replacement of linear regulators packaged in this industry standard footprint. The TPSM842xx devices provide much higher efficiency without the need of a heatsink.

Device Information⁽¹⁾

PART NUMBER	PACKAGE	BODY SIZE (NOM)
TPSM84203	EAB	10 mm x 11 mm
TPSM84205		
TPSM84212		

(1) For all available packages, see the orderable addendum at the end of the data sheet.

Device Comparison

PART NUMBER	OUTPUT VOLTAGE
TPSM84203	3.3 V
TPSM84205	5.0 V
TPSM84212	12.0 V

Simplified Application

TPSM842xx

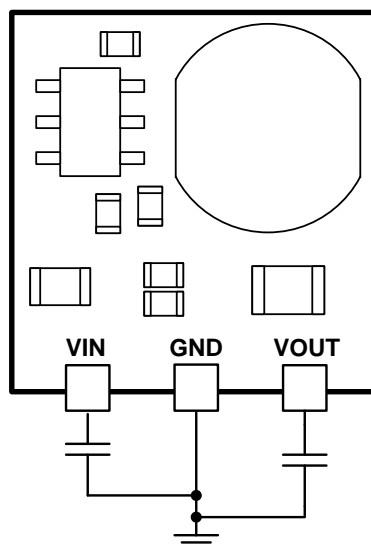

Copyright © 2017, Texas Instruments Incorporated



Table of Contents

1 Features	1	7.3 Feature Description	11
2 Applications	1	7.4 Device Functional Modes	13
3 Description	1	8 Application and Implementation	14
4 Revision History	2	8.1 Application Information	14
5 Pin Configuration and Functions	3	8.2 Typical Application	14
6 Specifications	4	9 Power Supply Recommendations	19
6.1 Absolute Maximum Ratings	4	10 Layout	19
6.2 Recommended Operating Conditions	4	10.1 Layout Guidelines	19
6.3 ESD Ratings	4	10.2 Layout Example	19
6.4 Thermal Information	5	11 Device and Documentation Support	20
6.5 Electrical Characteristics	5	11.1 Device Support	20
6.6 Switching Characteristics	6	11.2 Related Links	20
6.7 Typical Characteristics ($V_{OUT} = 3.3\text{ V}$)	7	11.3 Receiving Notification of Documentation Updates	20
6.8 Typical Characteristics ($V_{OUT} = 5\text{ V}$)	8	11.4 Community Resources	20
6.9 Typical Characteristics ($V_{OUT} = 12\text{ V}$)	9	11.5 Trademarks	20
7 Detailed Description	10	11.6 Electrostatic Discharge Caution	21
7.1 Overview	10	11.7 Glossary	21
7.2 Functional Block Diagram	10	12 Mechanical, Packaging, and Orderable Information	21

4 Revision History

NOTE: Page numbers for previous revisions may differ from page numbers in the current version.

Changes from Original (July 2017) to Revision A	Page
• Added <i>Feature</i> Meets EN55022 Class B Emissions	1
• Added the <i>EMI</i> section	16

5 Pin Configuration and Functions

**EAB Package
3-Pin Through-Hole
Top View**

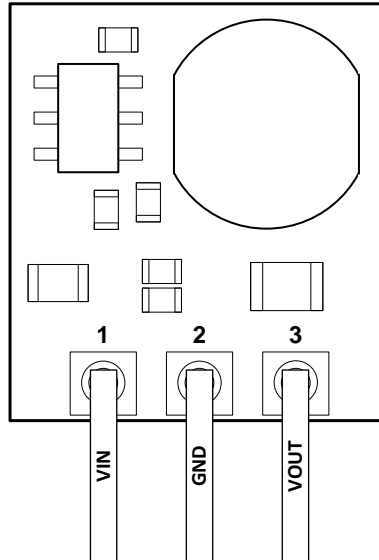

Pin Functions

PIN		I/O	DESCRIPTION
NAME	NO.		
GND	2		Ground. This is the return current path for the power stage of the device. Connect this pin to the bypass capacitors associated with VIN and VOUT.
VIN	1	I	Input Voltage. This pin supplies voltage to the control circuitry and power switches of the converter. Connect external bypass capacitors between this pin and GND.
VOUT	3	O	Output Voltage. This pin is connected to the internal output inductor. Connect this pin to the output load and connect external bypass capacitors between this pin and GND.

6 Specifications

6.1 Absolute Maximum Ratings

Over operating free-air temperature range (unless otherwise noted)⁽¹⁾

PARAMETER		MIN	MAX	UNIT
Input Voltage		−0.3	30	V
Output Voltage	TPSM84203	−0.3	3.9	V
	TPSM84205	−0.3	5.7	V
	TPSM84212	−0.3	13.0	V
Mechanical Shock	Mil-STD-883D, Method 2002.3, 1msec, 1/2 sine, mounted		1500	G
Mechanical Vibration	Mil-STD-883D, Method 2007.2, 20-2000Hz		10	G
Operating IC Junction Temperature range, T_J ⁽²⁾		−40	125	°C
Operating Ambient Temperature range, T_A ⁽²⁾		−40	85	°C
Storage temperature, T_{stg}		−60	150	°C

- (1) Stresses beyond those listed under *Absolute Maximum Ratings* may cause permanent damage to the device. These are stress ratings only, which do not imply functional operation of the device at these or any other conditions beyond those indicated under *Recommended Operating Conditions*. Exposure to absolute-maximum-rated conditions for extended periods may affect device reliability.
- (2) The ambient temperature is the air temperature of the surrounding environment. The junction temperature is the temperature of the internal power IC when the device is powered. Operating below the maximum ambient temperature, as shown in the safe operating area (SOA) curves, ensures that the maximum junction temperature of any component inside the module is never exceeded.

6.2 Recommended Operating Conditions

Over operating free-air temperature range (unless otherwise noted)

PARAMETER		MIN	MAX	UNIT
V_{IN} Input voltage	TPSM84203	4.5	28	V
	TPSM84205	7	28	V
	TPSM84212	14.5	28	V
I_{OUT} Output current		0	1.5	A
T_A Operating ambient temperature range ⁽¹⁾		−40	85	°C
T_J Operating junction temperature range ⁽¹⁾		−40	125	°C

- (1) The ambient temperature is the air temperature of the surrounding environment. The junction temperature is the temperature of the internal power IC when the device is powered. Operating below the maximum ambient temperature, as shown in the safe operating area (SOA) curves, ensures that the maximum junction temperature of any component inside the module is never exceeded.

6.3 ESD Ratings

		VALUE	UNIT
$V_{(ESD)}$ Electrostatic discharge	Human-body model (HBM), per ANSI/ESDA/JEDEC JS-001 ⁽¹⁾	±2500	V
	Charged-device model (CDM), per JEDEC specification JESD22-C101 ⁽²⁾	±1500	

- (1) JEDEC document JEP155 states that 500-V HBM allows safe manufacturing with a standard ESD control process.
- (2) JEDEC document JEP157 states that 250-V CDM allows safe manufacturing with a standard ESD control process.

6.4 Thermal Information

THERMAL METRIC ⁽¹⁾		TPSM842xx	
		EAB	UNIT
		3 PINS	
R _{θJA}	Junction-to-ambient thermal resistance ⁽²⁾	56	°C/W
ψ _{JT}	Junction-to-top characterization parameter ⁽³⁾	0.9	°C/W
ψ _{JB}	Junction-to-board characterization parameter ⁽⁴⁾	1.7	°C/W

- (1) For more information about traditional and new thermal metrics, see the [Semiconductor and IC Package Thermal Metrics](#) paper.
- (2) The junction-to-ambient thermal resistance, R_{θJA}, applies to devices soldered directly to a 50 mm × 50 mm double-sided PCB with 2 oz. copper and natural convection cooling. Additional airflow reduces R_{θJA}.
- (3) The junction-to-top characterization parameter, ψ_{JT}, estimates the junction temperature, T_J, of a device in a real system, using a procedure described in JESD51-2A (sections 6 and 7). T_J = ψ_{JT} × P_{dis} + T_T; where P_{dis} is the power dissipated in the device and T_T is the temperature of the top of the controller IC.
- (4) The junction-to-board characterization parameter, ψ_{JB}, estimates the junction temperature, T_J, of a device in a real system, using a procedure described in JESD51-2A (sections 6 and 7). T_J = ψ_{JB} × P_{dis} + T_B; where P_{dis} is the power dissipated in the device and T_B is the temperature of the module board 1 mm from the controller IC.

6.5 Electrical Characteristics

Over -40°C to +85°C free-air temperature range, V_{IN} = 24 V, I_{OUT} = I_{OUT} max, F_{SW} = 400 kHz, C_{IN} = 0.1μF, 50V ceramic; 10μF, 50V ceramic; 100μF, 35V electrolytic, and C_{OUT} = 2 × 47μF, 16V 1210 ceramic (unless otherwise noted)

PARAMETER		TEST CONDITIONS	MIN	TYP	MAX	UNIT
INPUT VOLTAGE (VIN)						
V _{IN}	Input voltage range	Over V _{OUT} range	TPSM84203	4.5 ⁽¹⁾	28	V
			TPSM84205	7 ⁽¹⁾	28	V
			TPSM84212	14.5 ⁽¹⁾	28	V
V _{IN_UVLO}	V _{IN} under voltage lock out	V _{IN} increasing		4.1	4.4	V
		V _{IN} decreasing	3.3	3.6		V
OUTPUT VOLTAGE (VOUT)						
V _{OUT}	Output voltage	Over I _{OUT} range	TPSM84203	3.3		V
			TPSM84205	5.0		V
			TPSM84212	12.0		V
	Set-point voltage tolerance	T _A = 25°C, I _{OUT} = 0 A	-3%		+3%	
	Temperature variation ⁽²⁾	-40°C ≤ T _A ≤ 85°C, I _{OUT} = 0 A		0.4%		
	Line regulation	Over V _{IN} range, I _{OUT} = 1 A		0.4%		
	Load regulation	Over I _{OUT} range		0.5%		
	Output voltage ripple	20 MHz bandwidth, peak-to-peak, I _{OUT} > 500 mA		15		mV
OUTPUT CURRENT						
I _{OUT}	Output current	See SOA graph for derating over temperature.	0		1.5	A
	Overcurrent threshold			3.1		A
PERFORMANCE						
η	Efficiency ⁽³⁾	V _{IN} = 5 V, I _{OUT} = 1 A	V _{OUT} = 3.3 V	92%		
			V _{OUT} = 5.0 V	92%		
		V _{IN} = 12 V, I _{OUT} = 1 A	V _{OUT} = 3.3 V	91%		
			V _{OUT} = 5.0 V	92%		
			V _{OUT} = 3.3 V	87%		
			V _{OUT} = 5.0 V	90%		
V _{IN} = 24 V, I _{OUT} = 1 A	V _{OUT} = 12.0 V	94%				
	Transient response ⁽²⁾	1 A/μs load step, 25% to 75% I _{OUT} (max), C _{OUT} = 94 μF	V _{OUT} over/undershoot	4%		V _{OUT}
			Recovery time	100		μs

- (1) The minimum input voltage is the lowest ensured voltage that will produce the nominal output voltage. See the [Drop-Out Voltage](#) section for information on drop-out voltage.
- (2) Specified by design. Not production tested.
- (3) See the efficiency graphs in the Typical Characteristics section for efficiency over the entire load range.

Electrical Characteristics (continued)

Over -40°C to +85°C free-air temperature range, $V_{IN} = 24\text{ V}$, $I_{OUT} = I_{OUT\text{ max}}$, $F_{SW} = 400\text{ kHz}$, $C_{IN} = 0.1\mu\text{F}$, 50V ceramic; 10 μF , 50V ceramic; 100 μF , 35V electrolytic, and $C_{OUT} = 2 \times 47\mu\text{F}$, 16V 1210 ceramic (unless otherwise noted)

PARAMETER		TEST CONDITIONS	MIN	TYP	MAX	UNIT
SOFT START						
T_{SS}	Internal soft start time ⁽²⁾			5		ms
THERMAL SHUTDOWN						
	Rising threshold ⁽²⁾			165		°C
	Hysteresis ⁽²⁾			10		°C
CAPACITANCE						
C_{IN}	External input capacitance	Ceramic type	10			μF
		Non-ceramic type	0	100		μF
C_{OUT}	External output capacitance	Ceramic type	TPSM84203	94	470	μF
			TPSM84205			
			TPSM84212	47	470	μF
		Total output capacitance	0	500 ⁽⁴⁾	μF	
	Equivalent series resistance (ESR)			35		m Ω

(4) The maximum output capacitance of 500 μF includes the combination of both ceramic and non-ceramic capacitors.

6.6 Switching Characteristics

Over operating free-air temperature range (unless otherwise noted)

PARAMETER		TEST CONDITIONS	MIN	TYP	MAX	UNIT
F_{SW}	Switching frequency		290	400	510	kHz

6.7 Typical Characteristics ($V_{OUT} = 3.3\text{ V}$)

Typical characteristic data has been developed from actual products tested at 25°C. This data is considered typical for the device. Safe operating area curves were measured using a Texas Instruments evaluation module (EVM).

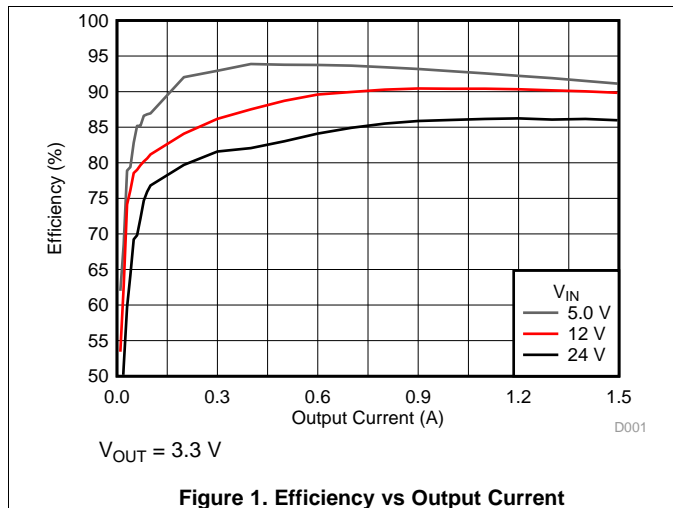

Figure 1. Efficiency vs Output Current

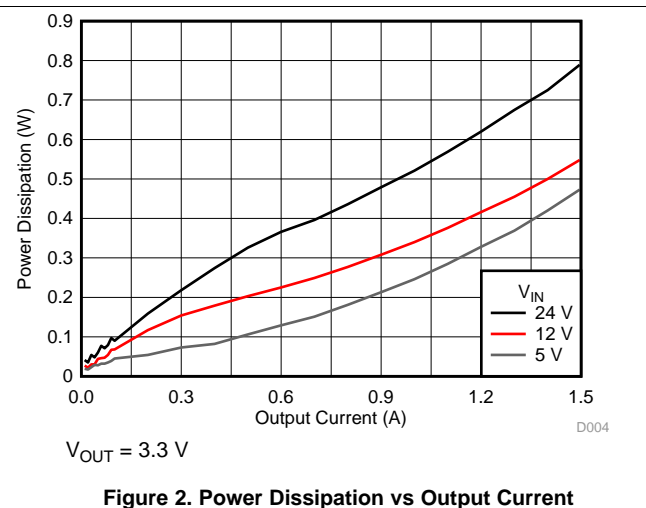

Figure 2. Power Dissipation vs Output Current

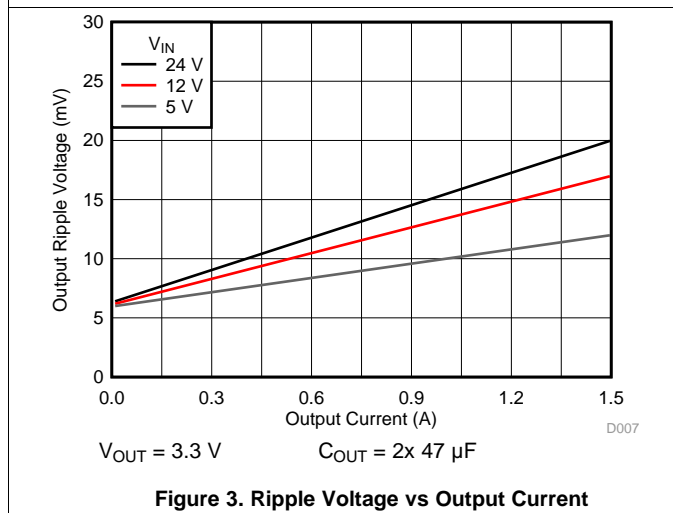

Figure 3. Ripple Voltage vs Output Current

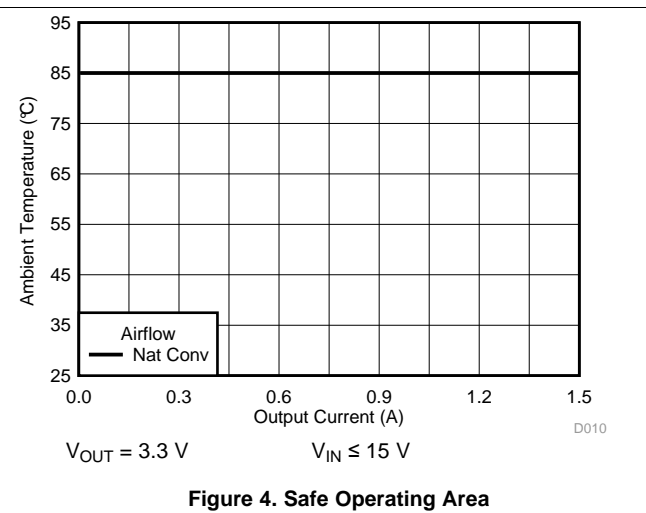

Figure 4. Safe Operating Area

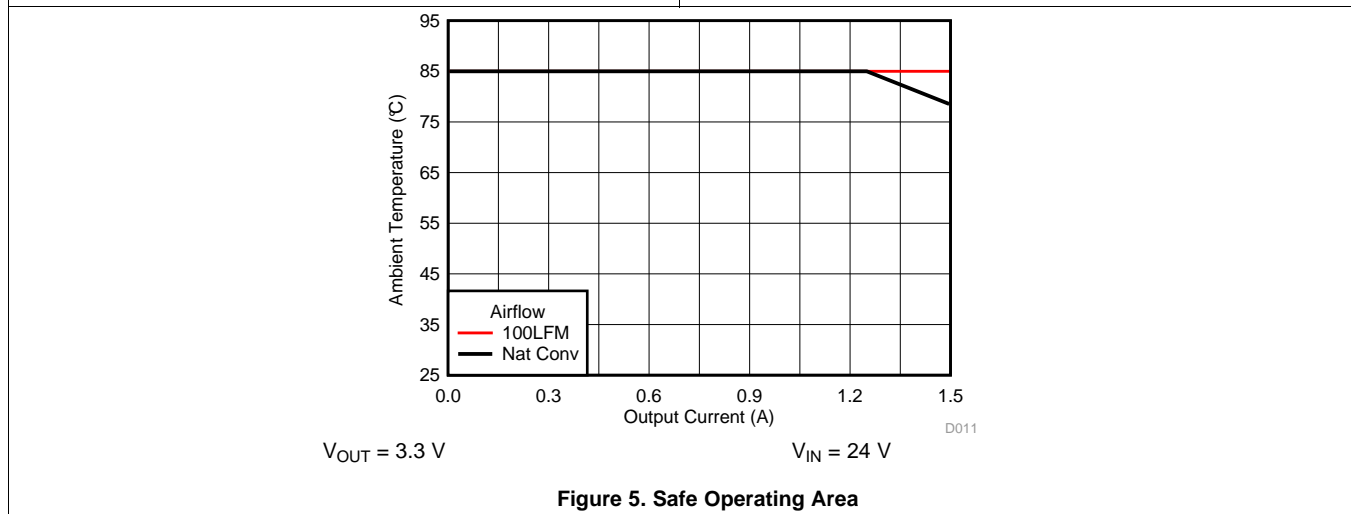

Figure 5. Safe Operating Area

6.8 Typical Characteristics ($V_{OUT} = 5\text{ V}$)

Typical characteristic data has been developed from actual products tested at 25°C. This data is considered typical for the device. Safe operating area curves were measured using a Texas Instruments evaluation module (EVM).

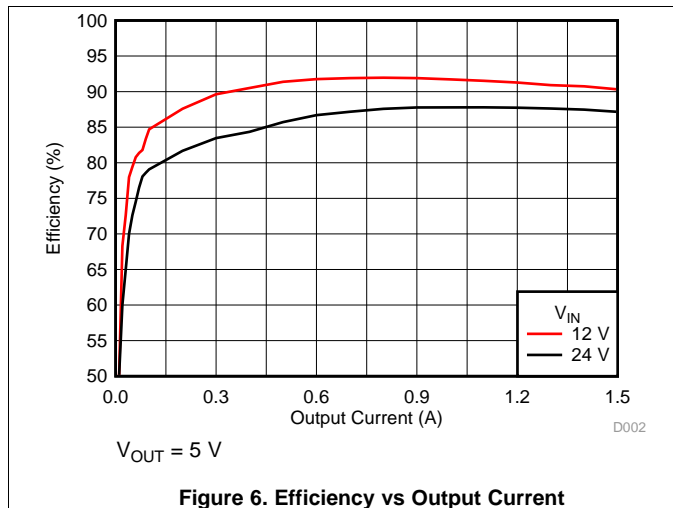

Figure 6. Efficiency vs Output Current

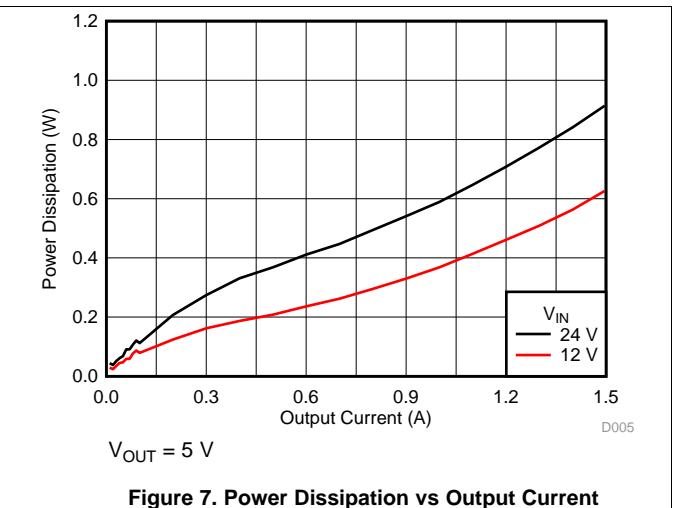

Figure 7. Power Dissipation vs Output Current

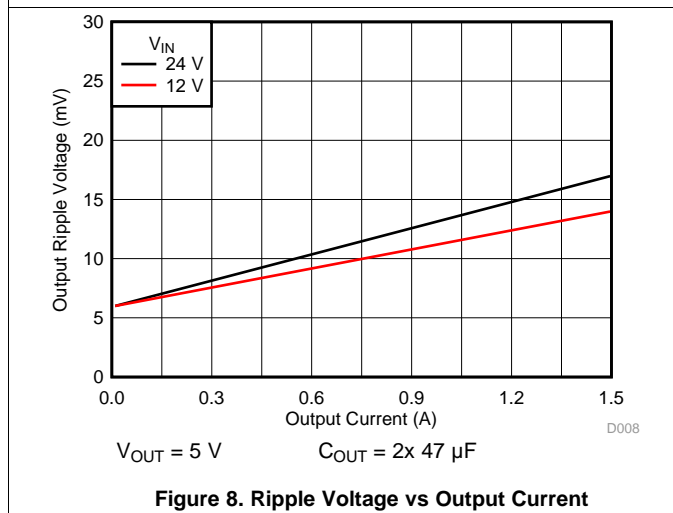

Figure 8. Ripple Voltage vs Output Current

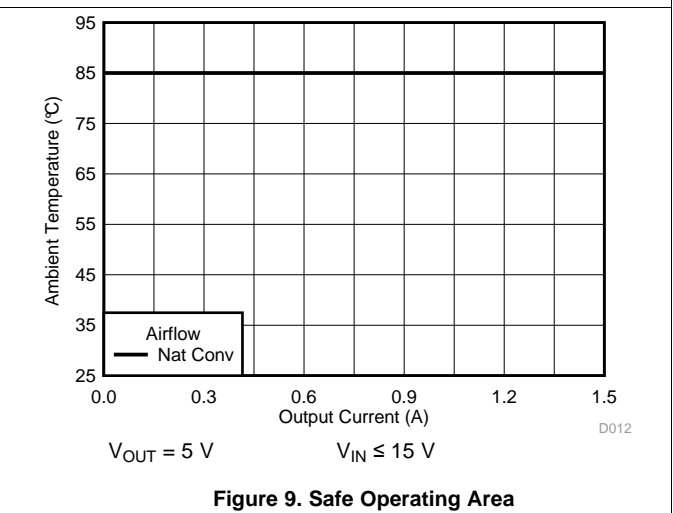

Figure 9. Safe Operating Area

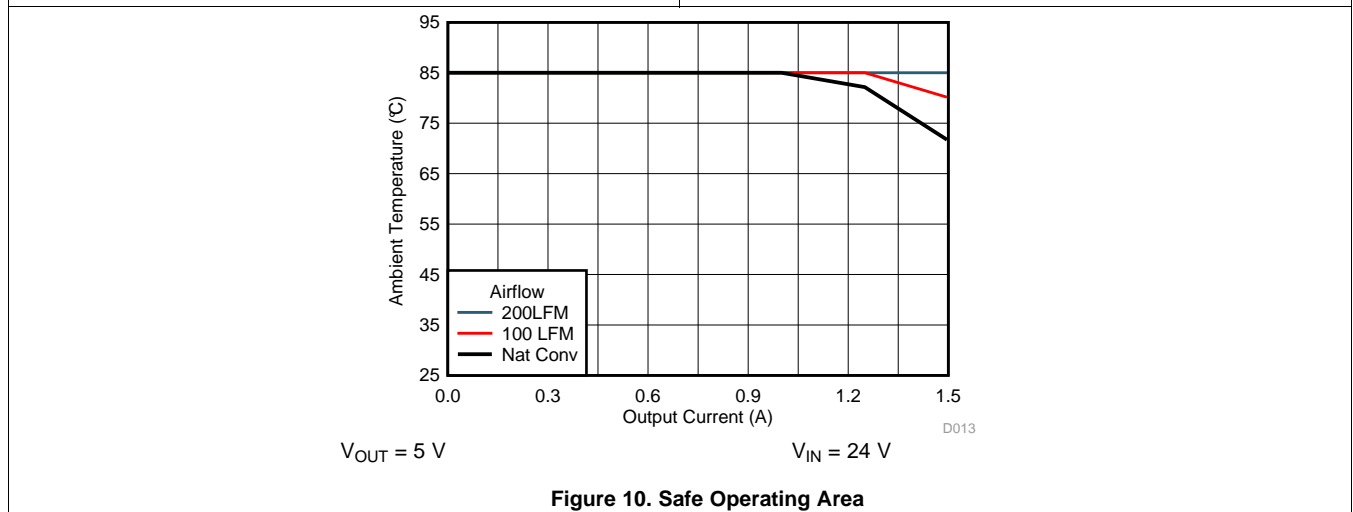
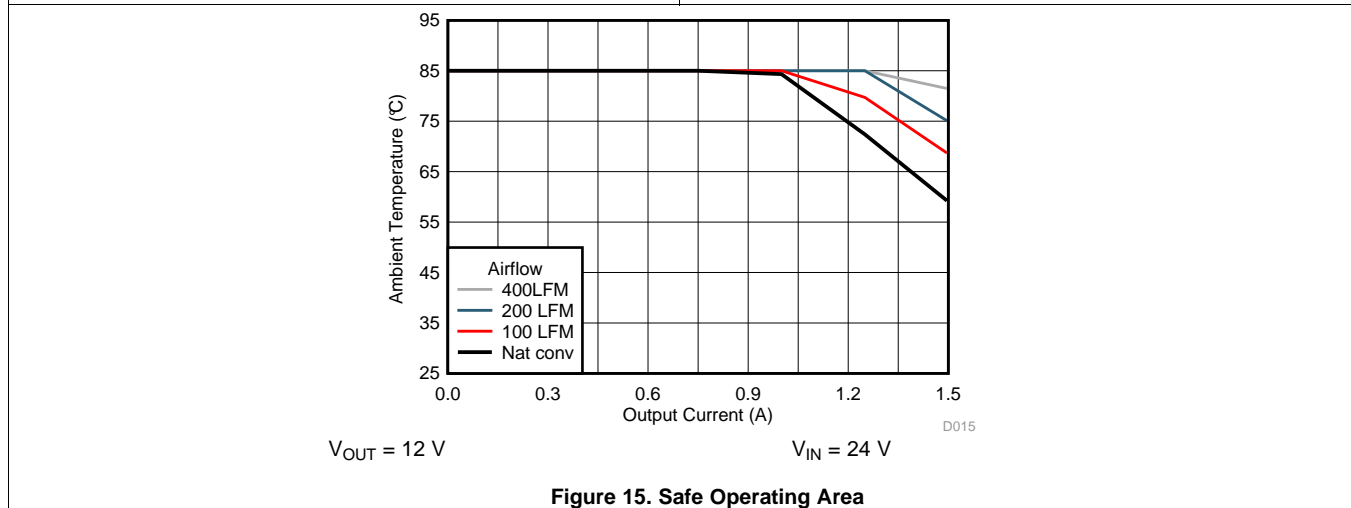
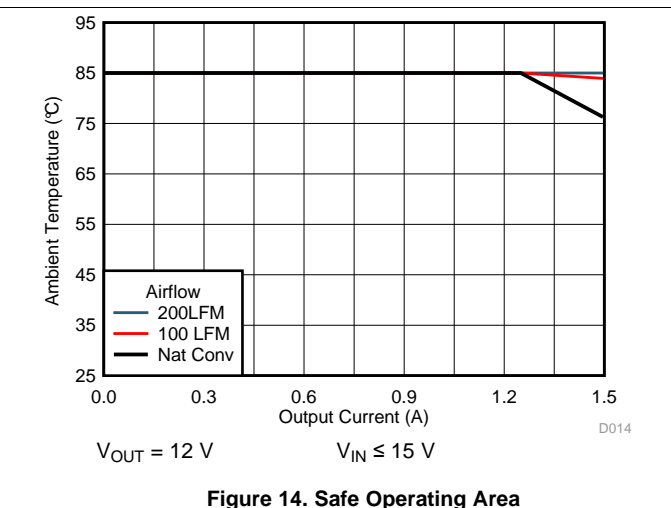
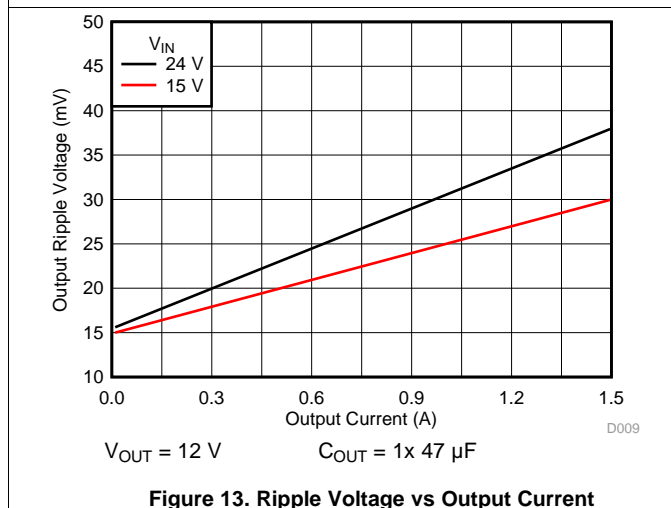
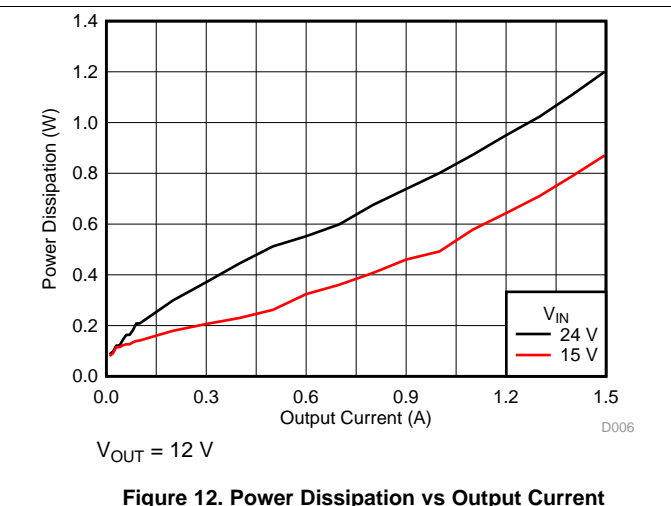
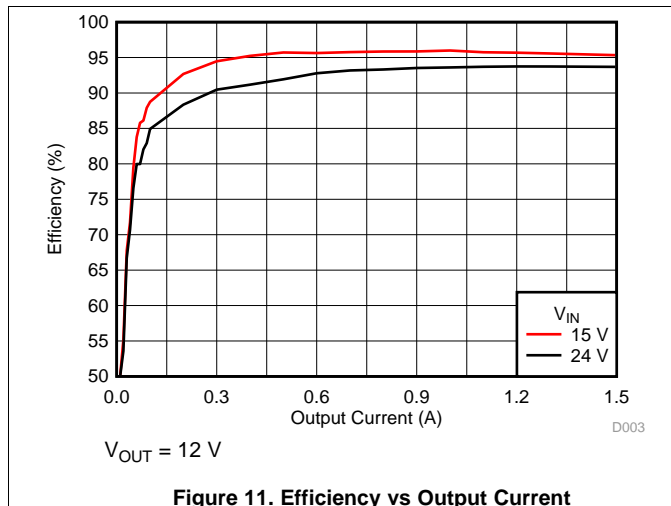

Figure 10. Safe Operating Area

6.9 Typical Characteristics ($V_{OUT} = 12\text{ V}$)

Typical characteristic data has been developed from actual products tested at 25°C. This data is considered typical for the device. Safe operating area curves were measured using a Texas Instruments evaluation module (EVM).



7 Detailed Description

7.1 Overview

The TPSM84203, TPSM84205, and TPSM84212 devices are 28 V input, 1.5 A, synchronous step down converters with PWM, MOSFETs, inductor, and control circuitry integrated into a TO-220 footprint package. The device integration enables small designs, while improving efficiency over a traditional linear regulator design. The TPSM842xx family provides fixed output voltages of 3.3 V, 5.0 V and 12.0 V. The fixed 400 kHz (typ) switching frequency allows small size and low output voltage ripple. Under light load conditions, these devices are designed to operate in high-efficiency pulse-skipping mode. These devices provide accurate voltage regulation for a variety of loads by using a precision internal voltage reference. These devices have been designed to safely start up into a pre-biased output voltage. Thermal shutdown and current limit features protect the device during an overload condition. The 3-pin, TO-220 footprint package offers improved performance over traditional linear regulators packaged in the standard footprint.

7.2 Functional Block Diagram

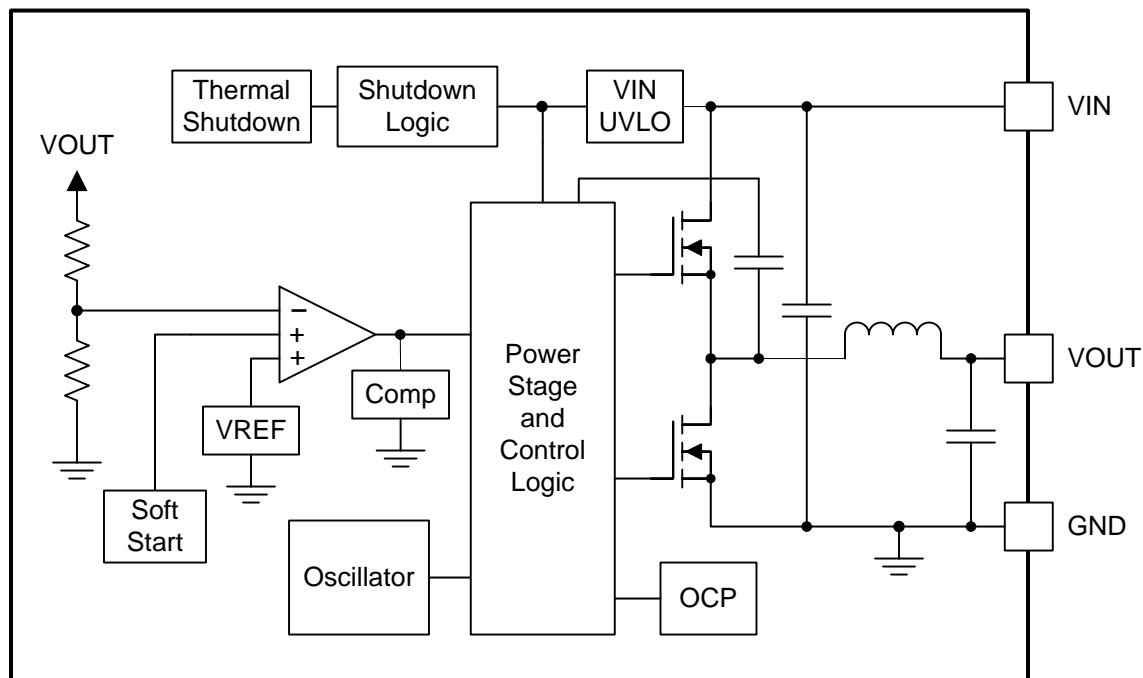

Copyright © 2017, Texas Instruments Incorporated

7.3 Feature Description

7.3.1 Input Capacitors

The TPSM842xx devices require a minimum input capacitance of 10 μF of ceramic type. High-quality ceramic type X5R or X7R capacitors with sufficient voltage rating are recommended. An additional 100 μF of non-ceramic capacitance is recommended for applications with transient load requirements. The voltage rating of input capacitors must be greater than the maximum input voltage.

Table 1. Recommended Input Capacitors⁽¹⁾

VENDOR	SERIES	PART NUMBER	CAPACITOR CHARACTERISTICS		
			WORKING VOLTAGE (V)	CAPACITANCE ⁽²⁾ (μF)	ESR ⁽³⁾ (m Ω)
Murata	X7R	GRM32ER71H475KA88L	50	4.7	2
TDK	X5R	C3225X5R1H106K250AB	50	10	3
Murata	X7R	GRM32ER71H106KA12	50	10	2
TDK	X7R	C3225X7R1H106M250AB	50	10	3
Panasonic	ZA	EEHZA1H101P	50	100	28

(1) Consult capacitor suppliers regarding availability, material composition, RoHS and lead-free status, and manufacturing process requirements for any capacitors identified in this table.

(2) Standard capacitance values

(3) Maximum ESR @ 100kHz, 25°C.

7.3.2 Output Capacitors

The TPSM84203 and TPSM84205 devices require a minimum output capacitance of 94 μF (2x 47 μF) of ceramic type. The TPSM84212 device requires a minimum output capacitance of 47 μF of ceramic type. High-quality X5R or X7R ceramic capacitors with sufficient voltage rating are recommended. Additional output capacitance is recommended for applications with transient load requirements. The voltage rating of output capacitors must be greater than the maximum output voltage.

Table 2. Recommended Output Capacitors⁽¹⁾

VENDOR	SERIES	PART NUMBER	CAPACITOR CHARACTERISTICS		
			WORKING VOLTAGE (V)	CAPACITANCE ⁽²⁾ (μF)	ESR ⁽³⁾ (m Ω)
TDK	X5R	C3225X5R0J476K	6.3	47	2
Murata	X5R	GRM32ER61C476K	16	47	3
TDK	X5R	C3225X5R0J107M	6.3	100	2
Murata	X5R	GRM32ER60J107M	6.3	100	2
Murata	X5R	GRM32ER61A107M	10	100	2
Kemet	X5R	C1210C107M4PAC7800	16	100	2
Panasonic	POSCAP	6TPE100MI	6.3	100	18
Panasonic	POSCAP	6TPF220M9L	6.3	220	9
Panasonic	POSCAP	6TPE220ML	6.3	220	12
Panasonic	POSCAP	6TPF330M9L	6.3	330	9
Panasonic	POSCAP	16TQC47MYFD	16	47	55

(1) Consult capacitor suppliers regarding availability, material composition, RoHS and lead-free status, and manufacturing process requirements for any capacitors identified in this table.

(2) Standard capacitance values.

(3) Maximum ESR @ 100kHz, 25°C.

7.3.3 Drop-Out Voltage

The drop-out voltage of a voltage regulator is the difference between the input voltage and the output voltage that is required to maintain regulation. Figure 16 and Figure 17 show typical drop-out voltage graphs for TPSM84205 at ambient temperatures of 25°C and 85°C. Figure 18 and Figure 19 show typical drop-out voltage graphs for TPSM84212 at ambient temperatures of 25°C and 85°C.

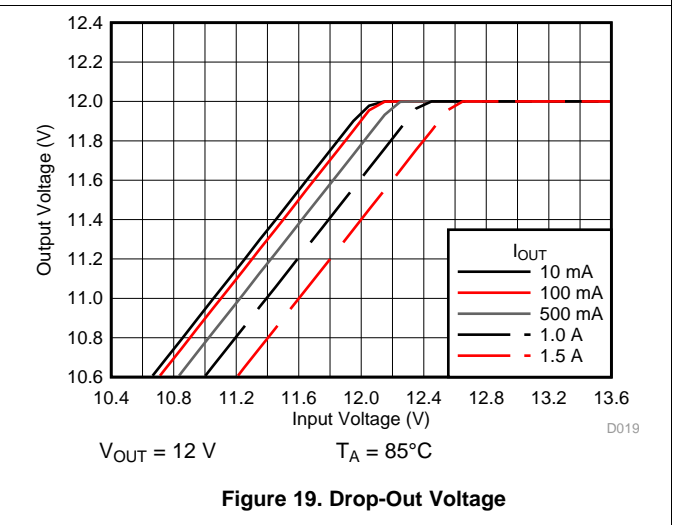
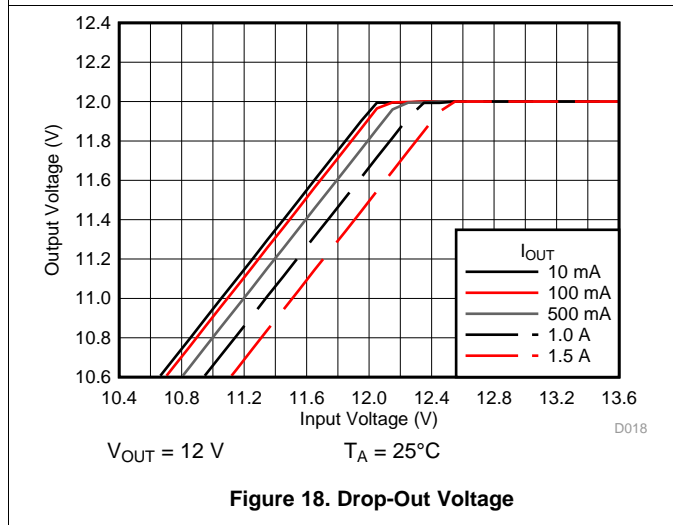
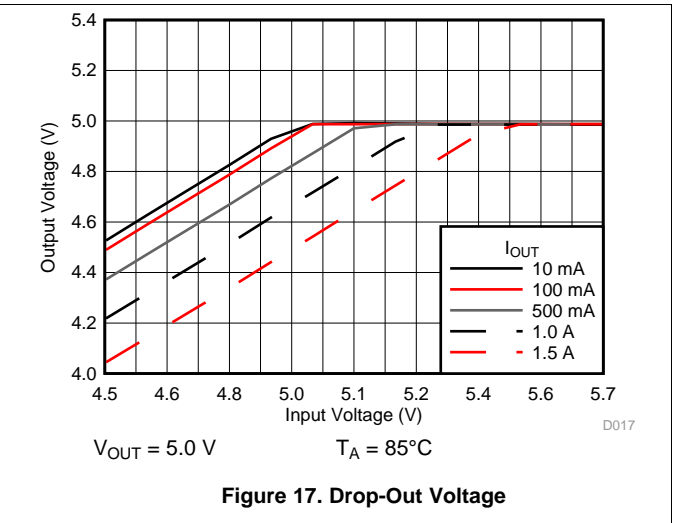
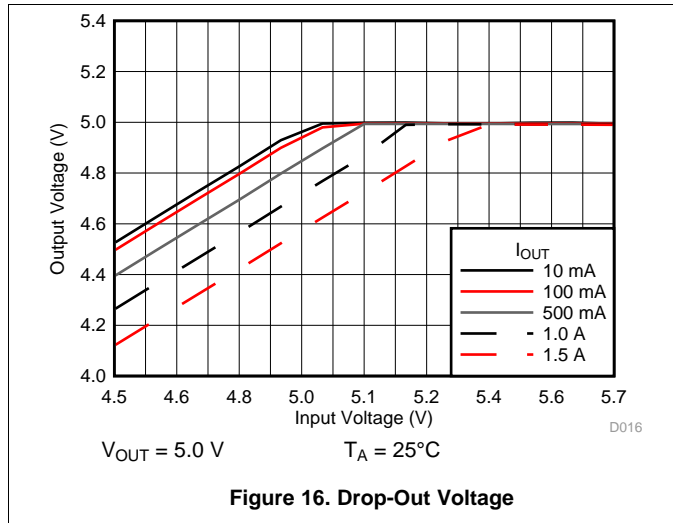

7.3.4 Internal Soft-Start

The device starts up under control of the internal soft-start function. The internal soft start time is set to 5 ms typically.

7.3.5 Safe Startup into Pre-Biased Outputs

The device has been designed to prevent the low-side MOSFET from discharging a pre-biased output. During monotonic pre-biased startup, both high-side and low-side MOSFETs are not allowed to be turned on until the internal soft-start voltage is higher than the internal feedback voltage.

7.3.6 Over-Current Protection

The device is protected from overcurrent conditions by cycle-by-cycle current limiting. If an output overload condition occurs for more than 1.28 ms, the device shuts down and restarts after approximately 40 ms. The hiccup mode helps to reduce the device power dissipation under severe overcurrent conditions.

7.3.7 Output Over-Voltage Protection

An output over voltage protection circuit is incorporated to minimize output voltage overshoot when recovering from output fault conditions or strong unload transients. When the output voltage goes above $108\% \times V_{OUT}$, the high-side MOSFET is forced off. When the output voltage falls below $104\% \times V_{OUT}$, the high-side MOSFET is enabled again.

7.3.8 Thermal Shutdown

The internal thermal-shutdown circuitry forces the device to stop switching if the junction temperature exceeds 165°C typically. The device reinitiates the power-up sequence when the junction temperature drops below 155°C typically.

7.4 Device Functional Modes

7.4.1 Normal Operation

The TPSM842xx devices operate in Normal operation mode when the input voltage is above the minimum input voltage. In Normal operation mode, the device operates in continuous conduction mode (CCM) which occurs when inductor peak current is above 840 mA typically. In CCM, the TPSM842xx devices operate at a fixed frequency of 400 kHz (typ). In addition, to reduce EMI, the devices introduce frequency spread spectrum. The jittering frequency range is $\pm 6\%$ of the switching frequency with a 780 Hz modulation rate.

7.4.2 Eco-mode™ Operation

The TPSM842xx devices operate in Eco-mode operation in light load conditions. Eco-mode is a high-efficiency, pulse-skipping mode under light load conditions. Pulse skipping initiates when the switch current falls to 840 mA typically. During pulse skipping, the low-side FET turns off when the switch current falls to 0 A. The device takes on the characteristics of discontinuous conduction mode (DCM) operation and the apparent switching frequency decreases. As the output current decreases, the perceived time between switching pulses increases.

8 Application and Implementation

NOTE

Information in the following applications sections is not part of the TI component specification, and TI does not warrant its accuracy or completeness. TI's customers are responsible for determining suitability of components for their purposes. Customers should validate and test their design implementation to confirm system functionality.

8.1 Application Information

The TPSM842xx devices are step down DC-DC power modules. They convert a higher DC voltage to a lower DC voltage of 3.3 V, 5 V, or 12 V with a maximum output current of 1.5 A. The following design procedure can be used to select components for the TPSM842xx devices. Alternately, the WEBENCH® software may be used to generate complete designs. When generating a design, the WEBENCH software utilizes an iterative design procedure and accesses comprehensive databases of components. Please visit www.ti.com/WEBENCH for more details.

8.2 Typical Application

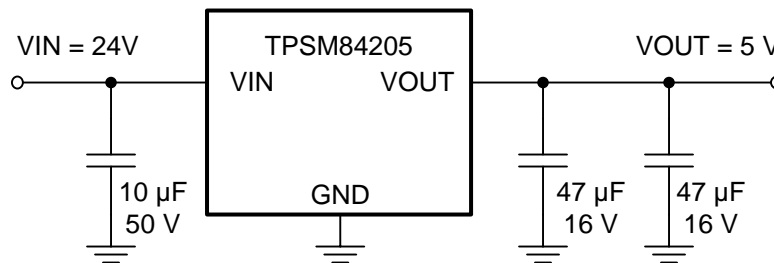

Copyright © 2017, Texas Instruments Incorporated

Figure 20. Typical Application

8.2.1 Design Requirements

For this design example, use the parameters listed in [Table 3](#) and follow the design procedures below.

Table 3. Design Parameters

DESIGN PARAMETER	VALUE
Input Voltage V_{IN}	24-V typical
Output Voltage V_{OUT}	5.0 V
Output Current Rating	1.5 A
Key care-about	TO-220 footprint, high efficiency

8.2.2 Detailed Design Procedure

8.2.2.1 Custom Design With WEBENCH® Tools

[Click here](#) to create a custom design using the TPSM84203 device with the WEBENCH® Power Designer.

1. Start by entering the input voltage (V_{IN}), output voltage (V_{OUT}), and output current (I_{OUT}) requirements.
2. Optimize the design for key parameters such as efficiency, footprint, and cost using the optimizer dial.
3. Compare the generated design with other possible solutions from Texas Instruments.

The WEBENCH Power Designer provides a customized schematic along with a list of materials with real-time pricing and component availability.

In most cases, these actions are available:

- Run electrical simulations to see important waveforms and circuit performance
- Run thermal simulations to understand board thermal performance
- Export customized schematic and layout into popular CAD formats
- Print PDF reports for the design, and share the design with colleagues

Get more information about WEBENCH tools at www.ti.com/WEBENCH.

8.2.2.2 Input and Output Capacitors

The TPSM842xx devices require both input and output capacitance for proper operation. The minimum required input capacitance for all of the TPSM842xx devices is 10 μF of ceramic capacitance placed directly at the device pins. The minimum required output capacitance for the TPSM84203 and TPSM84205 is 2x 47 μF of ceramic type. The TPSM84212 requires only one 47 μF ceramic output capacitor. Additional capacitance can be added to improve ripple or transient response.

For this application, the minimum required input capacitance of 10 μF , ceramic was added and 2x 47 μF ceramic capacitance was added to the output.

8.2.3 Application Curves

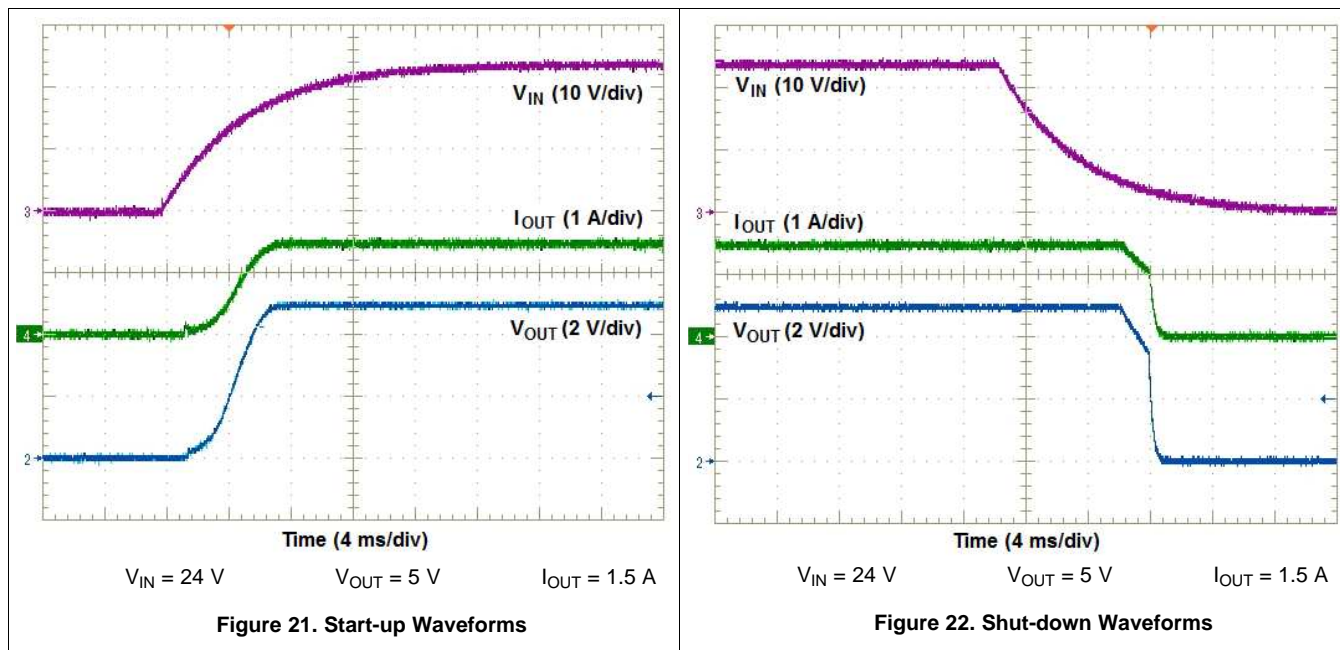

8.2.3.1 EMI

The TPSM842xx devices are all compliant with EN55022 Class B radiated emissions. [Figure 23](#) to [Figure 27](#) show typical examples of radiated emissions plots for the TPSM842xx devices. The EMI plots were taken using a web-orderable EVM with a resistive load. Input power was provided using a lead acid battery. All graphs show plots of the antenna in the horizontal and vertical positions.

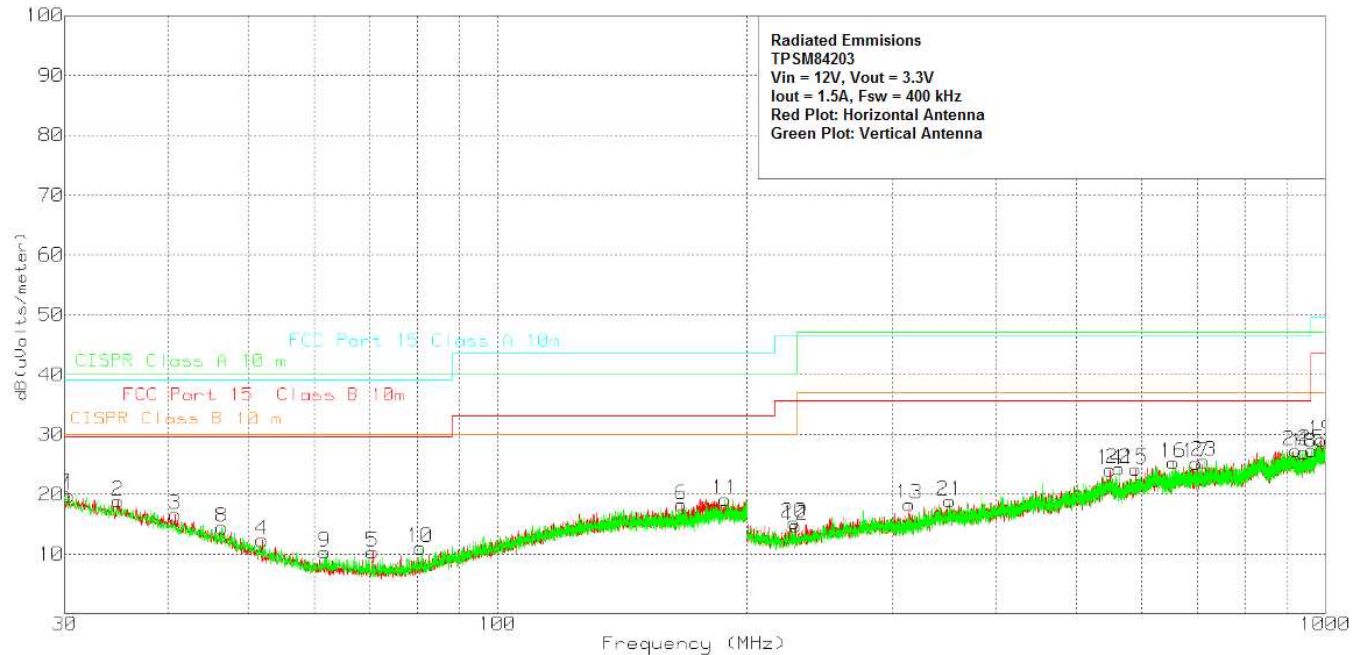

Figure 23. Radiated Emissions 12-V Input, 3.3-V Output, 1.5-A Load, Horizontal and Vertical Antenna

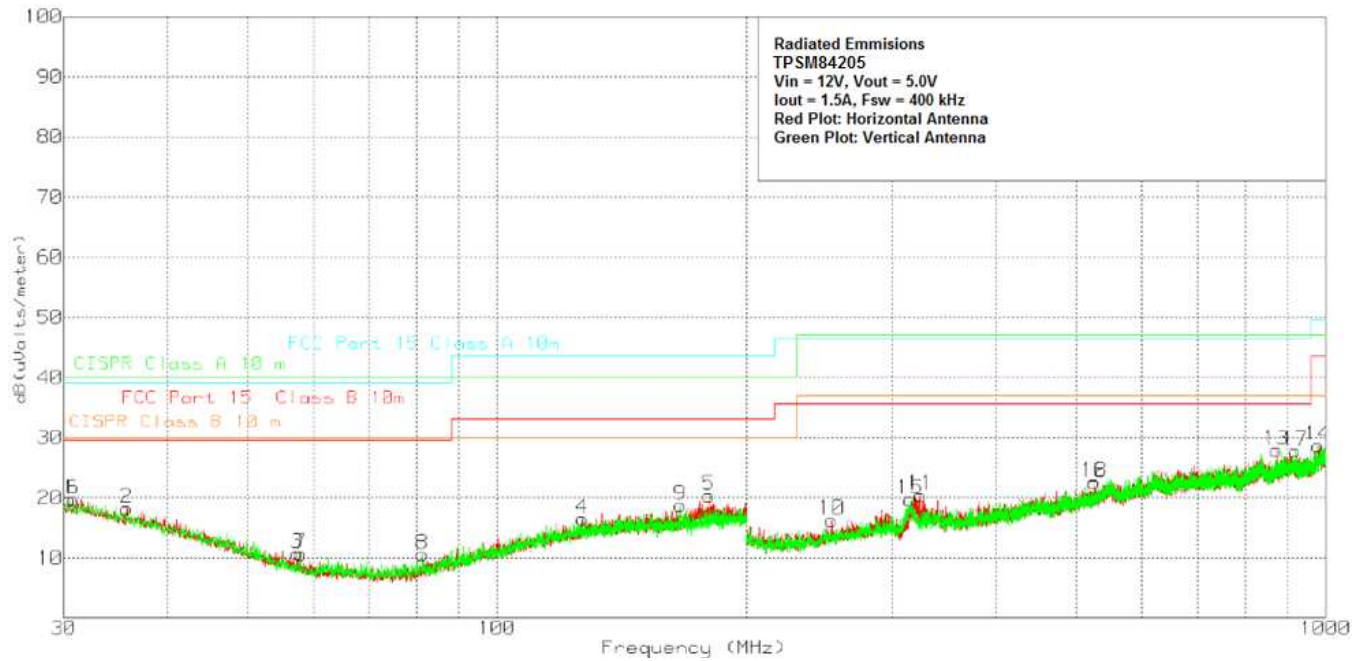

Figure 24. Radiated Emissions 12-V Input, 5.0-V Output, 1.5-A Load, Horizontal and Vertical Antenna

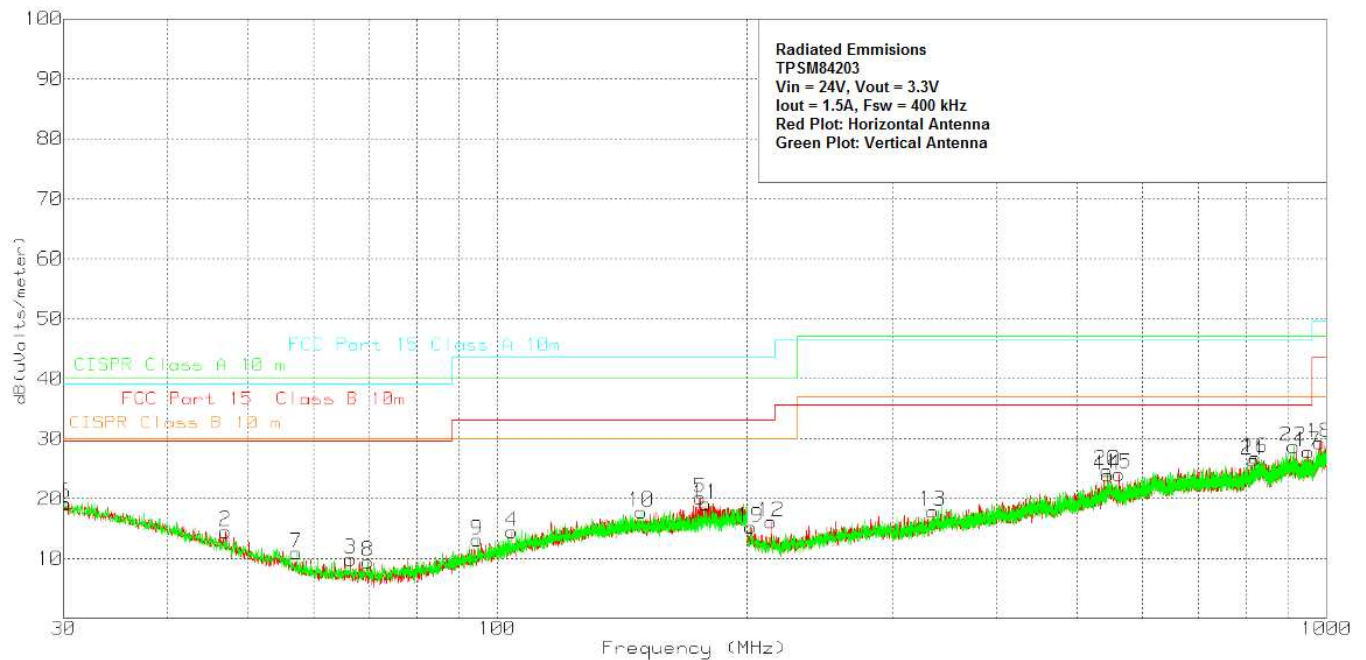

Figure 25. Radiated Emissions 24-V Input, 3.3-V Output, 1.5-A Load, Horizontal and Vertical Antenna

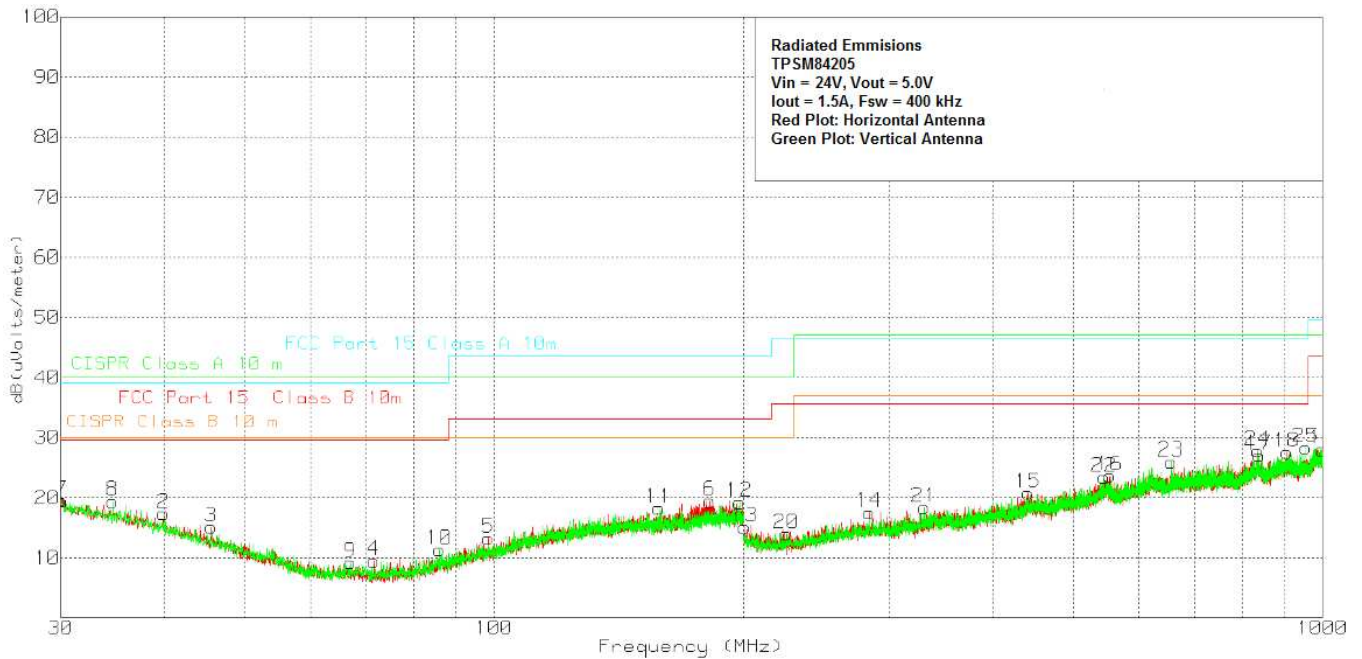

Figure 26. Radiated Emissions 12-V Input, 5.0-V Output, 1.5-A Load, Horizontal and Vertical Antenna

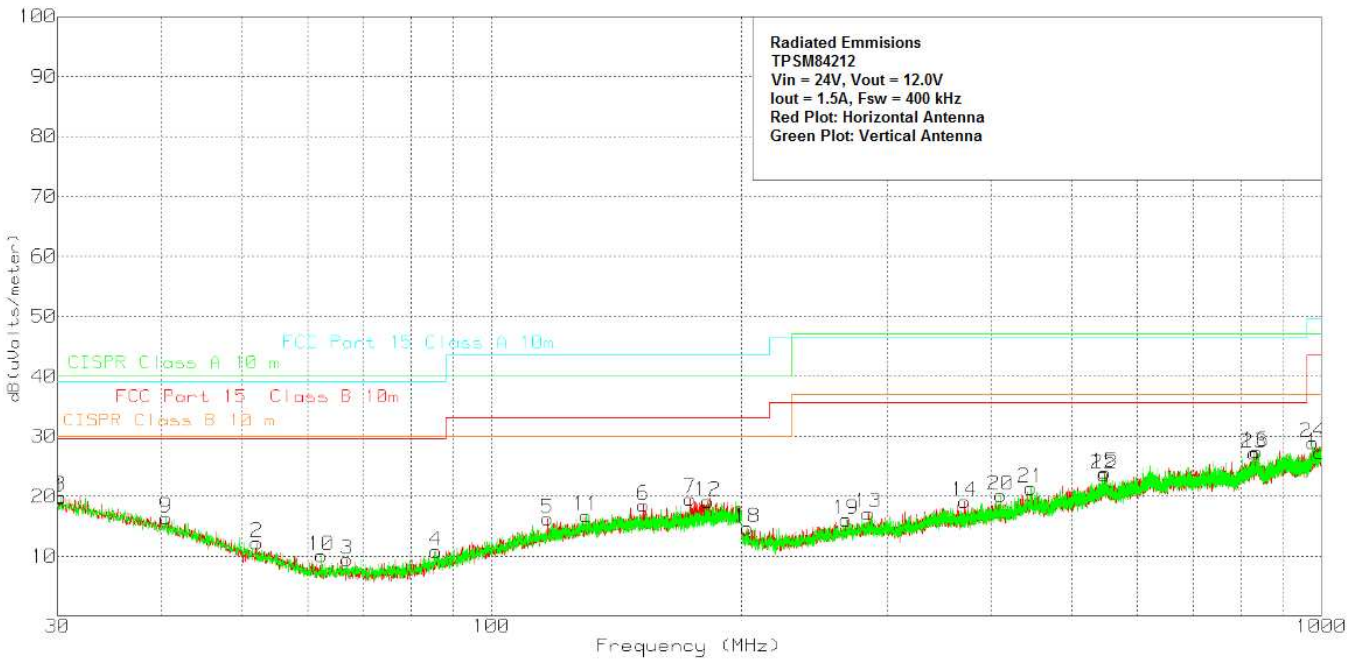

Figure 27. Radiated Emissions 24-V Input, 12-V Output, 1.5-A Load, Horizontal and Vertical Antenna

9 Power Supply Recommendations

The TPSM842xx devices are designed to operate from an input voltage supply between 4.5 V and 28 V. This supply must be well regulated. Proper bypassing of input supply is critical for noise performance, as is PCB layout and grounding scheme. See the recommendations in the [Layout](#) section.

10 Layout

10.1 Layout Guidelines

To achieve optimal electrical and thermal performance, an optimized PCB layout is required. [Figure 28](#) shows a typical PCB layout. Some considerations for an optimized layout are:

- Use large copper areas for power planes (VIN, VOUT, and GND) to minimize conduction loss and thermal stress.
- Place ceramic input and output capacitors close to the device pins to minimize high frequency noise.
- Locate additional output capacitors between the ceramic capacitor and the load.
- Use multiple vias to connect the power planes to internal layers.

10.2 Layout Example

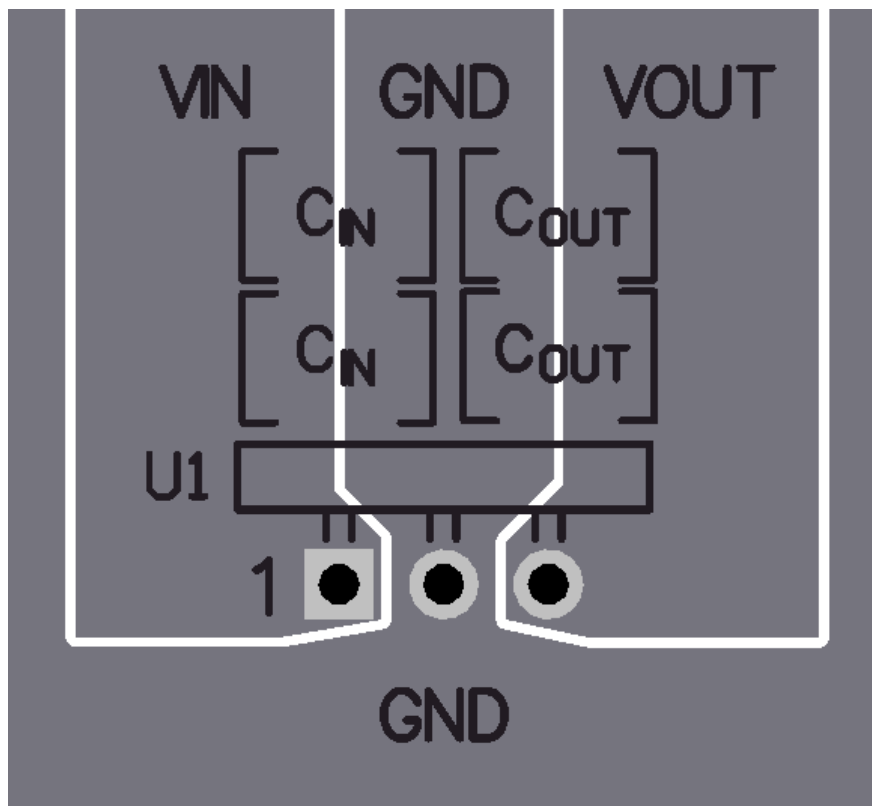

Figure 28.

11 Device and Documentation Support

11.1 Device Support

11.1.1 Development Support

11.1.1.1 Custom Design With WEBENCH® Tools

[Click here](#) to create a custom design using the TPSM84203 device with the WEBENCH® Power Designer.

1. Start by entering the input voltage (V_{IN}), output voltage (V_{OUT}), and output current (I_{OUT}) requirements.
2. Optimize the design for key parameters such as efficiency, footprint, and cost using the optimizer dial.
3. Compare the generated design with other possible solutions from Texas Instruments.

The WEBENCH Power Designer provides a customized schematic along with a list of materials with real-time pricing and component availability.

In most cases, these actions are available:

- Run electrical simulations to see important waveforms and circuit performance
- Run thermal simulations to understand board thermal performance
- Export customized schematic and layout into popular CAD formats
- Print PDF reports for the design, and share the design with colleagues

Get more information about WEBENCH tools at www.ti.com/WEBENCH.

11.2 Related Links

The table below lists quick access links. Categories include technical documents, support and community resources, tools and software, and quick access to sample or buy.

Table 4. Related Links

PARTS	PRODUCT FOLDER	SAMPLE & BUY	TECHNICAL DOCUMENTS	TOOLS & SOFTWARE	SUPPORT & COMMUNITY
TPSM84203	Click here	Click here	Click here	Click here	Click here
TPSM84205	Click here	Click here	Click here	Click here	Click here
TPSM84212	Click here	Click here	Click here	Click here	Click here

11.3 Receiving Notification of Documentation Updates

To receive notification of documentation updates, navigate to the device product folder on ti.com. In the upper right corner, click on *Alert me* to register and receive a weekly digest of any product information that has changed. For change details, review the revision history included in any revised document.

11.4 Community Resources

The following links connect to TI community resources. Linked contents are provided "AS IS" by the respective contributors. They do not constitute TI specifications and do not necessarily reflect TI's views; see TI's [Terms of Use](#).

TI E2E™ Online Community *TI's Engineer-to-Engineer (E2E) Community*. Created to foster collaboration among engineers. At e2e.ti.com, you can ask questions, share knowledge, explore ideas and help solve problems with fellow engineers.

Design Support *TI's Design Support* Quickly find helpful E2E forums along with design support tools and contact information for technical support.

11.5 Trademarks

Eco-mode, E2E are trademarks of Texas Instruments.
 WEBENCH is a registered trademark of Texas Instruments.
 All other trademarks are the property of their respective owners.

11.6 Electrostatic Discharge Caution



This integrated circuit can be damaged by ESD. Texas Instruments recommends that all integrated circuits be handled with appropriate precautions. Failure to observe proper handling and installation procedures can cause damage.

ESD damage can range from subtle performance degradation to complete device failure. Precision integrated circuits may be more susceptible to damage because very small parametric changes could cause the device not to meet its published specifications.

11.7 Glossary



[SLYZ022](#) — *TI Glossary*.

This glossary lists and explains terms, acronyms, and definitions.

12 Mechanical, Packaging, and Orderable Information

The following pages include mechanical, packaging, and orderable information. This information is the most current data available for the designated devices. This data is subject to change without notice and revision of this document. For browser-based versions of this data sheet, refer to the left-hand navigation.

PACKAGING INFORMATION

Orderable Device	Status (1)	Package Type	Package Drawing	Pins	Package Qty	Eco Plan (2)	Lead finish/ Ball material (6)	MSL Peak Temp (3)	Op Temp (°C)	Device Marking (4/5)	Samples
TPSM84203EAB	ACTIVE	SIP MODULE	EAB	3	80	RoHS Exempt & Green	SN	N / A for Pkg Type	-40 to 125		
TPSM84205EAB	ACTIVE	SIP MODULE	EAB	3	80	RoHS Exempt & Green	SN	N / A for Pkg Type	-40 to 125		
TPSM84212EAB	ACTIVE	SIP MODULE	EAB	3	80	RoHS Exempt & Green	SN	N / A for Pkg Type	-40 to 125		

(1) The marketing status values are defined as follows:

ACTIVE: Product device recommended for new designs.

LIFEBUY: TI has announced that the device will be discontinued, and a lifetime-buy period is in effect.

NRND: Not recommended for new designs. Device is in production to support existing customers, but TI does not recommend using this part in a new design.

PREVIEW: Device has been announced but is not in production. Samples may or may not be available.

OBSELETE: TI has discontinued the production of the device.

(2) **RoHS:** TI defines "RoHS" to mean semiconductor products that are compliant with the current EU RoHS requirements for all 10 RoHS substances, including the requirement that RoHS substance do not exceed 0.1% by weight in homogeneous materials. Where designed to be soldered at high temperatures, "RoHS" products are suitable for use in specified lead-free processes. TI may reference these types of products as "Pb-Free".

RoHS Exempt: TI defines "RoHS Exempt" to mean products that contain lead but are compliant with EU RoHS pursuant to a specific EU RoHS exemption.

Green: TI defines "Green" to mean the content of Chlorine (Cl) and Bromine (Br) based flame retardants meet JS709B low halogen requirements of <=1000ppm threshold. Antimony trioxide based flame retardants must also meet the <=1000ppm threshold requirement.

(3) MSL, Peak Temp. - The Moisture Sensitivity Level rating according to the JEDEC industry standard classifications, and peak solder temperature.

(4) There may be additional marking, which relates to the logo, the lot trace code information, or the environmental category on the device.

(5) Multiple Device Markings will be inside parentheses. Only one Device Marking contained in parentheses and separated by a "~" will appear on a device. If a line is indented then it is a continuation of the previous line and the two combined represent the entire Device Marking for that device.

(6) Lead finish/Ball material - Orderable Devices may have multiple material finish options. Finish options are separated by a vertical ruled line. Lead finish/Ball material values may wrap to two lines if the finish value exceeds the maximum column width.

Important Information and Disclaimer:The information provided on this page represents TI's knowledge and belief as of the date that it is provided. TI bases its knowledge and belief on information provided by third parties, and makes no representation or warranty as to the accuracy of such information. Efforts are underway to better integrate information from third parties. TI has taken and continues to take reasonable steps to provide representative and accurate information but may not have conducted destructive testing or chemical analysis on incoming materials and chemicals. TI and TI suppliers consider certain information to be proprietary, and thus CAS numbers and other limited information may not be available for release.

In no event shall TI's liability arising out of such information exceed the total purchase price of the TI part(s) at issue in this document sold by TI to Customer on an annual basis.



PACKAGE OUTLINE

EAB0003A

SIPMODULE - 11.1 mm max height

SYSTEM IN PACKAGE MODULE

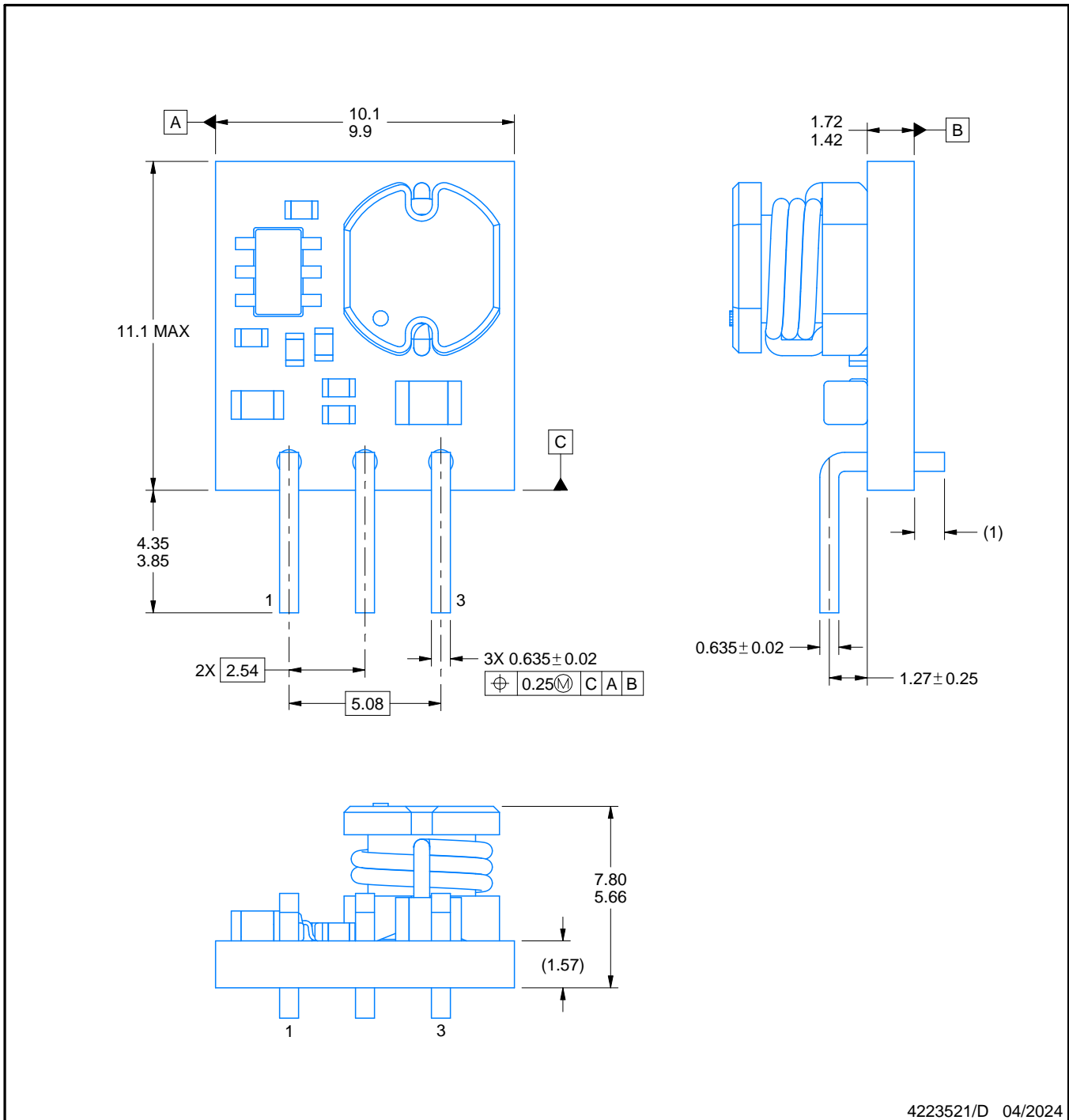

NOTES:

1. All linear dimensions are in millimeters. Any dimensions in parenthesis are for reference only. Dimensioning and tolerancing per ASME Y14.5M.
2. This drawing is subject to change without notice.
3. Location, size and quantity of each component are for reference only and may vary.

EXAMPLE BOARD LAYOUT

EAB0003A

SIPMODULE - 11.1 mm max height

SYSTEM IN PACKAGE MODULE

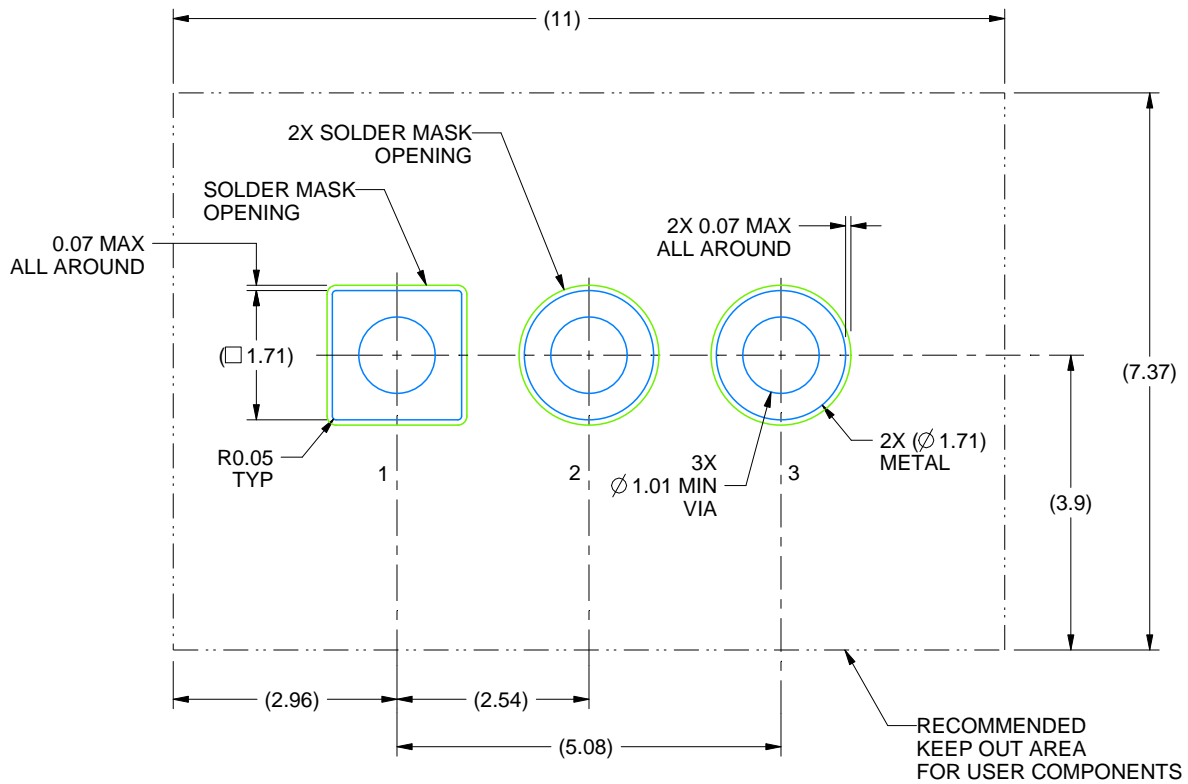

LAND PATTERN EXAMPLE
NON-SOLDER MASK DEFINED
SCALE:10X

4223521/D 04/2024

REVISIONS

REV	DESCRIPTION	ECR	DATE	ENGINEER / DRAFTER
A	RELEASE NEW DRAWING	2163130	02/07/2017	V. PAKU / T. LEQUANG
B	SIDE VIEW: ADD PIN CENTER TO PCB DIMENSION; REMOVE PIN EDGE TO PCB DIMENSION	2167747	08/14/2017	V. PAKU / K. SINCERBOX
C	4.35/3.85 WAS 4.1/3.5	2169958	11/20/2017	C. FERNANDEZ / K. SINCERBOX
D	1.27± 0.25 WAS 1.27± 0.025;	2208237	04/18/2024	A. VAZQUEZ / K. SINCERBOX

IMPORTANT NOTICE AND DISCLAIMER

TI PROVIDES TECHNICAL AND RELIABILITY DATA (INCLUDING DATA SHEETS), DESIGN RESOURCES (INCLUDING REFERENCE DESIGNS), APPLICATION OR OTHER DESIGN ADVICE, WEB TOOLS, SAFETY INFORMATION, AND OTHER RESOURCES "AS IS" AND WITH ALL FAULTS, AND DISCLAIMS ALL WARRANTIES, EXPRESS AND IMPLIED, INCLUDING WITHOUT LIMITATION ANY IMPLIED WARRANTIES OF MERCHANTABILITY, FITNESS FOR A PARTICULAR PURPOSE OR NON-INFRINGEMENT OF THIRD PARTY INTELLECTUAL PROPERTY RIGHTS.

These resources are intended for skilled developers designing with TI products. You are solely responsible for (1) selecting the appropriate TI products for your application, (2) designing, validating and testing your application, and (3) ensuring your application meets applicable standards, and any other safety, security, regulatory or other requirements.

These resources are subject to change without notice. TI grants you permission to use these resources only for development of an application that uses the TI products described in the resource. Other reproduction and display of these resources is prohibited. No license is granted to any other TI intellectual property right or to any third party intellectual property right. TI disclaims responsibility for, and you will fully indemnify TI and its representatives against, any claims, damages, costs, losses, and liabilities arising out of your use of these resources.

TI's products are provided subject to [TI's Terms of Sale](#) or other applicable terms available either on [ti.com](https://www.ti.com) or provided in conjunction with such TI products. TI's provision of these resources does not expand or otherwise alter TI's applicable warranties or warranty disclaimers for TI products.

TI objects to and rejects any additional or different terms you may have proposed.

Mailing Address: Texas Instruments, Post Office Box 655303, Dallas, Texas 75265
Copyright © 2024, Texas Instruments Incorporated