

AN-808 Long Transmission Lines and Data Signal Quality

ABSTRACT

This application note explores another important transmission line characteristic, the reflection coefficient. This concept is combined with the material in AN-806 to present graphical and analytical methods for determining the voltages and currents at any point on a line with respect to distance and time. The effects of various source resistances and line termination methods on the transmitted signal are also discussed. This application note is a revised reprint of section four of the Fairchild Line Driver and Receiver Handbook. This application note, the third of a three part series (See AN-806 and AN-807), covers the following topics:

Contents

1	Overview	3
2	Introduction	3
3	Factors Causing Signal Wave Shape Changes	4
4	Influence of Loss Effects on Primary Line Parameters	5
5	Variations in Z_0 , $\alpha(\omega)$, and Propagation Velocity	6
6	Signal Quality—Terms	9
7	Signal Quality Measurement—The Eye Pattern	12
8	Other Pulse Codes and Signal Quality	17
	8.1 NON-RETURN TO ZERO (NRZ) PULSE CODES	18
	8.2 RETURN TO ZERO (RZ) PULSE CODES	20
	8.3 PHASE ENCODED (PE) PULSE CODES	21
	8.4 MULTI-LEVEL BINARY (PLB) PULSE CODES	23
9	References	26

List of Figures

1	Current Distributions Across and Conductor for Several Frequencies.....	5
2	Variations in Primary Parameters as a Function of Frequency (22 AWG Polyethylene Insulated Twisted Pair).....	7
3	Variations in Primary Parameters as a Function of Frequency (22 AWG Polyethylene Insulated Twisted Pair).....	7
4	Typical Variation in Z_0 as a Function of Frequencies	7
5	Attenuation vs Frequency.....	8
6	Propagation Velocity vs Frequency.....	9
7	Data Transmission System.....	10
8	NRZ Signaling.....	11
9	Bias Distortion.....	12
10	Comparison of NRZ Random Data and “Dotting” Signals	13
11	Formation of an Eye Pattern by Superposition	13
12	Bench Set-Up to Measure Data Signal Quality.....	14
13	NRZ Data Eye Pattern	14
14	Using Eye Pattern to Determine Characteristic Resistance of Line	14
15	Signal Quality as a Function of Line Length and Modulation Rate for Terminated 24 AWG Twisted Pair (PVC Insulation)	16

All trademarks are the property of their respective owners.

16	Eye Patterns for NRZ Data Corresponding to Various Peak-to-Peak Transition Jitter.....	17
17	Receiver Bias Effect on Total Isochronous Distortion	18
18	Non-Return to Zero (NRZ) Pulse Codes	19
19	Return to Zero (RZ) Pulse Codes	21
20	Phase Encoded (PE) Pulse Codes	23
21	Multilevel Binary (MLB) or Pseudoternary Pulse Codes	25

1 Overview

This application note explores another important transmission line characteristic, the reflection coefficient. This concept is combined with the material in AN-806 to present graphical and analytical methods for determining the voltages and currents at any point on a line with respect to distance and time. The effects of various source resistances and line termination methods on the transmitted signal are also discussed. This application note is a revised reprint of section four of the Fairchild Line Driver and Receiver Handbook. This application note, the third of a three part series (See AN-806 and AN-807), covers the following topics:

- Factors Causing Signal Wave-Shape Changes
- Influence of Loss Effects on Primary Line Parameters
- Variations in Z_0 , $\alpha(\omega)$ and Propagation Velocity
- Signal Quality—Terms
- Signal Quality Measurement—The Eye Pattern
- Other Pulse Codes and Signal Quality

2 Introduction

Transmission lines as discussed in AN-806 and AN-807 have always been treated as ideal lossless lines. As a consequence of this simplified model, the signals passing along the lines did not change in shape, but were only delayed in time. This time delay is given as the product of per-unit-length delay and line length ($\tau = l\delta$). Unfortunately, real transmission lines always possess some finite resistance per unit length due to the resistance of the conductors composing the line. So, the lossless model only represents *short* lines where this resistance term can be neglected. In AN-806 the per-unit-length line parameters, L, R, C, G, were assumed to be both constant and independent of frequency (up to the limits mentioned, of course). But with real lines, this is not strictly correct as four effects alter the per-unit-length parameters, making some of them frequency dependent. These four effects are skin effect, proximity effect, radiation loss effect, and dielectric loss effect. These effects and how they influence the intrinsic line parameters are discussed later in this application note. Since these effects make simple ac analysis virtually impossible, operational (Laplace) calculus is usually applied to various simplified line models to provide somewhat constrained analytical solutions to line voltages and currents. These analytical solutions are difficult to derive, perhaps even more difficult to evaluate, and their accuracy of prediction depends greatly on line model accuracy. Analytical solutions for various lines (primarily coaxial cables) appear in the references, so only the salient results are examined here.

Engineers designing data transmission circuits are not usually interested in the esoterica of lossy transmission line theory. Instead, they are concerned with the following question: given a line length of x feet and a data rate of n bps, does the system work—and if so—what amount of transition jitter is expected? To answer this question using analytical methods is quite difficult because evaluation of the expressions representing the line voltage or current as a function of position and time is an involved process. The references at the end of this application note provide a starting point to generate and evaluate analytical expressions for a given cable.

The effects on the LRCG line parameters, the variations in Z_0 , $\alpha(\omega)$, and propagation velocity as a function of applied frequency are discussed later in this application note. Using an empirical approach to answer the “how far—how fast” question involves only easily made laboratory measurements on that selected cable. This empirical approach, using the binary eye pattern as the primary measurement tool, enables the construction of a graph showing the line length/data rate/signal quality trade-offs for a particular cable. The terms describing *signal quality* are discussed later in this application note. The technique of using actual measurements from cables rather than theoretical predictions is not as subject to error as the analytical approach. The only difficulties in the empirical method are the requirements for a high quality, real time (or random sampling) oscilloscope and, of course, the requisite amount of transmission line to be tested.

Also discussed in this application note are commonly used pulse codes.

3 Factors Causing Signal Wave Shape Changes

In AN-806 and AN-807, it was assumed that the transmission lines were ideal so the step functions propagated along the lines without any change in wave shape. Because a single pulse is actually composed of a continuous (Fourier) spectrum, the phase velocity independence on an applied frequency, and the absence of attenuation ($R = 0$, $G = 0$) of the ideal line always allows the linear addition of these frequency components to reconstruct the original signal without alteration. For real lines, unfortunately, the series resistance is not quite zero, and the phase velocity is slightly dependent on the applied frequency. The latter results in *dispersion*; *i.e.*, the propagation velocity will differ for the various frequencies, while the former results in signal *attenuation* (reduction in amplitude). This attenuation may also be a function of frequency. Attenuation and dispersion cause the frequency components of a signal, at some point down the line, to be quite different from the frequency components of the signal applied to the input of the line. Thus, at some point down the line, the frequency components add together to produce a wave shape that may differ significantly from the input signal wave shape. In many ways, then, a real transmission line may be thought of as a distributed lowpass filter with loss. The fast rise and fall times of the signals become progressively “rounded” due to attenuation and dispersion of the high frequency signal components.

It should be noted that there is a theoretical condition where attenuation is independent of frequency and dispersion is zero. This results in a line causing signal amplitude reduction, but no change in signal wave shape. This condition was first discussed by Heavyside and is called the *distortionless* line. To make a line distortionless, the primary line parameters must satisfy the relation $(R/L) = (G/C)$. Because for real lines $(R/L) > (G/C)$, the distortionless line is only of historical interest, and it is not possible to satisfy the $(R/L) = (G/C)$ condition over a sufficiently wide bandwidth to allow a proper transmission of short duration pulses. Over a limited frequency range such as that encountered in telephony (0 kHz–4 kHz), the L term can be increased by either adding lumped inductances at fixed intervals along the line or by winding a magnetic material (as a thin tape) around the conductors of the line throughout its length. Lumped loading is commonly applied to long telephone circuits to reduce the signal attenuation over a narrow frequency range; however this linearity is at the expense of in-band attenuation and non-linear delay distortion. The distributed loading method has been tried, but the mechanical characteristics of the magnetic materials have made the winding process very difficult. In any event, neither method allows short pulses to retain their wave shapes. The interest in line loading to produce the Heavyside condition for pulse transmission is therefore largely academic.

The following sections discuss the origins of the secondorder effects—skin effect, proximity effect, radiation loss effect, and dielectric loss effect—and their influence on the LRCG transmission line parameters.

- Skin Effect: The phenomenon is based on two facts: a current flow in any real conductor produces an electric field given by Ohm’s Law; the current distribution and/or magnetic field distribution in a conductor is frequency dependent. For dc current in a single isolated conductor, the current density is uniform across the conductor. When alternating current is used, the current density is not uniform across the conductor. Instead, the current tends to concentrate on the conductor surface. Current density continuously increases from the conductor center to its surface, but for practical purposes, the current *penetration depth*, d , is assumed as a dividing line for current density. The current is assumed to flow in a imaginary cylinder of thickness d with a constant current density throughout the cylinder thickness. Distribution of current densities for both actual and assumed models is shown in [Figure 1](#).
 - It can be seen that for *classical* skin effects, the penetration depth is given by

$$d = \kappa \frac{1}{\sqrt{f}} \tag{1}$$
 - where

$$\kappa = 1/\sqrt{\pi\mu\sigma}, \tag{2}$$
 - μ = magnetic permeability of the conducting material expressed in henries per unit length, and Σ = conductivity of the conducting material. For MKS (SI) units and for a copper conductor

$$\Sigma = 5.85 \times 10^7 (\Omega \text{ meter})^{-1} \tag{3}$$

$$\mu = 4\pi \times 10^{-7} (\text{H/meter}) \tag{4}$$
 - in which case, d would be the penetration depth expressed in meters.
 - Because the skin effect reduces the equivalent conductor cross-sectional area, increasing frequencies cause an increase in the effective resistance per unit length of the line. This in turn leads to signal attenuation increasing with frequency. If the frequency response of a cable is plotted on log-log graph paper, log dB, or Nepers vs log frequency, the curve slope will be 0.5 if the cable

losses are primarily governed by *classical* skin effects. The slope of the attenuation curve, along with the attenuation at a particular frequency, can be used to estimate coaxial cable transient response as a function of length.^{2, 4}

NOTE: *See Reference 2 and 4.

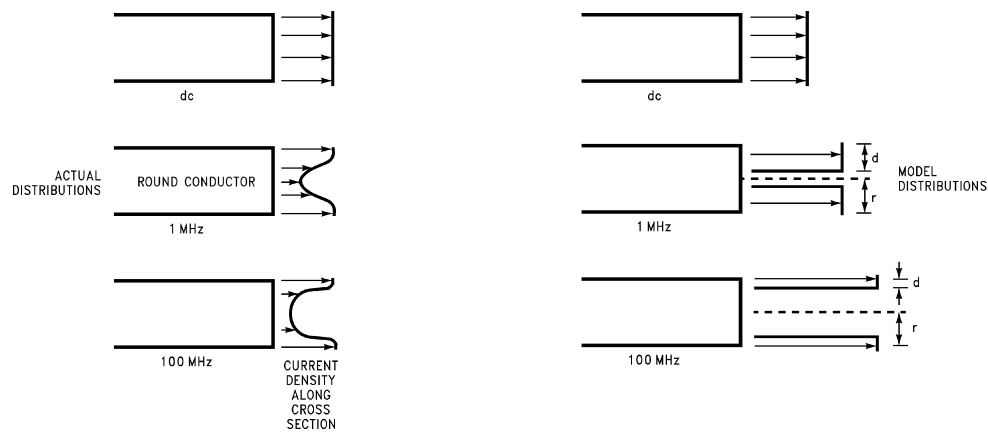

Figure 1. Current Distributions Across and Conductor for Several Frequencies

- **Proximity Effect:** This is a current density redistribution in a conductor due to the mutual repulsion (or attraction) generated by currents flowing in nearby conductors. The current density at those points on the conductor close to neighboring conductors varies from the current density when the conductor is isolated from other conductors. This current density redistribution reduces the effective cross-sectional area of the conductor, thereby increasing the per-unit-length line resistance. This effect is a function of the conductor diameters, the separation of the conductors from each other, and frequency. The analytical evaluation of the proximity effect is quite complicated and except for certain limited cases*, no general rule of thumb expressions have been proposed. The proximity effect is not present in coaxial cables because of their circular symmetry. The proximity effect is a significant contributor to signal losses particularly in cases of a twisted pair or parallel wire lines.
- **Radiation Loss:** Radiation losses cause an apparent rise in resistance per unit length increasing with frequency. The mechanism of radiation loss is energy dissipation either as heat or magnetization via eddy currents in nearby metallic or magnetic masses, with the eddy currents induced by line currents. Coaxial cables do not exhibit this effect because the signal magnetic field is confined between the shield and the outside of the center conductor. Ideally, the magnetic field produced by shield current cancels the field produced by current in the center conductor (for points outside the shield).
 - Both twisted pair and parallel wire lines exhibit radiation losses and these losses contribute to the effective per-unit-length line resistance. Radiation loss is dependent to a large extent on the characteristics of the materials close to the line; so radiation loss is quite difficult to calculate, but can be measured if necessary.
- **Dielectric Loss Effect:** Dielectric losses result from leakage currents through the dielectric material. This causes an increase in the shunt conductance per unit length and produces signal attenuation. Fortunately, for most dielectric materials in common use, this loss is very small particularly for frequencies below 250 MHz. For most practical purposes, then, dielectric losses may be neglected as they are usually overshadowed by skin effect losses.

4 Influence of Loss Effects on Primary Line Parameters

Resistance Per Unit Length, R . It is composed of a basic dc resistance term R_{dc} plus the contributions of skin effect, proximity effect and radiation loss effect. For coaxial lines, the proximity and radiation loss effects are negligible in most cases, so the primary contribution is made by the skin effect. Thus the resistance per unit length becomes

$$R = R_{dc} + Ks^m \tag{5}$$

where $0 < m < 1$.

NOTE: *See References Arnold¹¹ and Dwight¹² **See References 5 and 6

For 2-wire lines (twisted pair, parallel wire), the resistance per unit length is increased by the skin effect. For closely spaced wires, however, the proximity effect also contributes significantly to a resistance increase. Radiation loss should also be included, but is very difficult to calculate because it depends on the surroundings of the line.

Inductance Per Unit Length, L. It can be shown** that, as the frequency is increased, the skin effect, proximity effect, and radiation loss effect cause a reduction in the effective per-unit-length self-inductance of the line.

Capacitance Per Unit Length, C. This depends primarily on the dielectric constant of the insulating medium and conductor geometry. This term is constant over a wide range of frequencies for most dielectrics (Teflon, Polyethylene). For Polyvinylchloride (PVC) insulation, the relative dielectric constant shows a decrease as frequency increases ($\epsilon_r \approx 4.7$ @ 1 kHz, $\epsilon_r \approx 2.9$ @ 100 MHz). The capacitance per unit length, therefore, will show a decrease corresponding with increasing frequency for PVC insulation and little change for most other dielectrics.

Conductance Per Unit Length, G. Because resistance per unit length usually has a much greater magnitude, this value is negligible. When this term cannot be neglected, it is represented as

$$G = \omega C \tan \phi \quad (6)$$

where C is capacitance per unit length, ω is the angular frequency ($= 2 \pi f$) and $\tan \phi$ is a dielectric material coefficient. The angle ϕ is called the dielectric loss angle. This angle is usually quite small (< 0.005 radians) for the majority of dielectrics up to several hundred megahertz.

5 Variations in Z_0 , $\alpha(\omega)$, and Propagation Velocity

The variations in the primary line parameters as a function of frequency shown by [Figure 2](#) and [Figure 3](#) have a profound influence on the three secondary line parameters of characteristic impedance, attenuation, and velocity of propagation.

In the expression for the characteristic impedance of a line,

$$Z_0 = \sqrt{\frac{R + j\omega L}{G + j\omega C}} \quad (7)$$

at low frequencies, $j\omega L$ is small compared to R, and G is small compared to $j\omega C$. So the characteristic impedance is

$$\sqrt{R/j\omega C}. \quad (8)$$

At high frequencies, the increase in R is overshadowed by $j\omega L$ even though L is being reduced. With G still much smaller than $j\omega C$, the characteristic impedance is almost a pure resistance

$$R_0 = \sqrt{L/C}. \quad (9)$$

The behavior of the characteristic impedance as a function of frequency ($Z_0 = R_0 - jX_0$) is shown in [Figure 4](#).

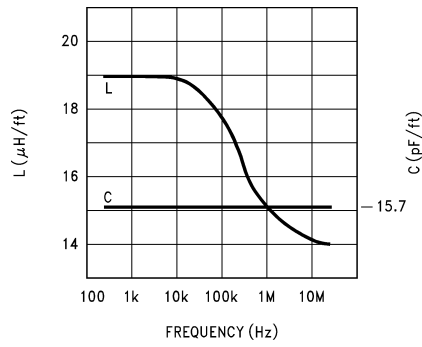

Figure 2. Variations in Primary Parameters as a Function of Frequency (22 AWG Polyethylene Insulated Twisted Pair)

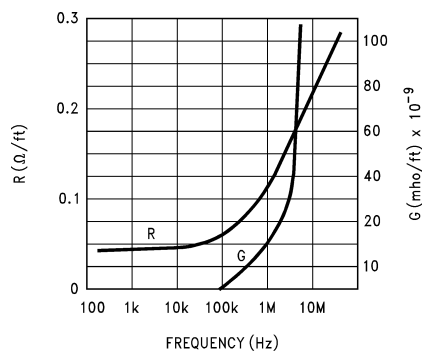

Figure 3. Variations in Primary Parameters as a Function of Frequency (22 AWG Polyethylene Insulated Twisted Pair)

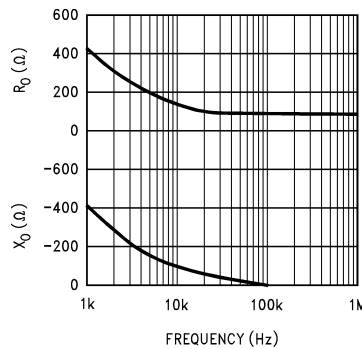
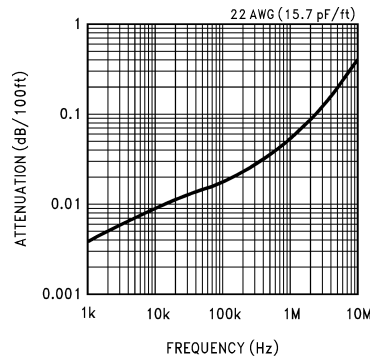

Figure 4. Typical Variation in Z_0 as a Function of Frequencies

Typical behavior of the line attenuation as a function of frequency is shown in [Figure 5](#). This line attenuation is the real part of the equation

$$\gamma(\omega) = \sqrt{(R + j\omega L)(G + j\omega C)}. \tag{10}$$

Figure 5. Attenuation vs Frequency

The change in resistance is the primary contributor to the attenuation increase as a function of frequency. For coaxial cables, this resistance increase is due primarily to the skin effect ($R_{SK} = Kf^m$). The slope of the attenuation curve on a log-log graph (log dB vs log frequency), therefore, is essentially linear and, at the same time, equal to m . For twisted pair and parallel wire lines, proximity effects and radiation losses make the curves less linear, but for high frequencies (over 100 kHz), the attenuation expressed in nepers per unit length is approximated by

$$\alpha \approx \frac{R}{2} \sqrt{\frac{C}{L}} \quad (11)$$

The R term is, of course, the sum of the dc resistance, plus the incremental resistance due to skin, proximity and radiation loss effects. This R term usually varies as follows.

$$R_{SK} = Kf^m \quad (12)$$

where $0.6 \leq m < 1.0$

The signal velocity propagation ($v = \omega/\beta$) is given by the imaginary part of the propagation constant γ . As shown in AN-807, v is a constant given by

$$v = \sqrt{LC} \quad (13)$$

for lossless lines. For real lines, this value is approached at high frequencies. At low frequencies, however, (when ω is small compared to R/L or G/C), then

$$v_{LF} \approx (C/2) \sqrt{R/G} \quad (14)$$

and the velocity is reduced. The propagation velocity as a function of frequency is shown in [Figure 6](#). This variation in signal velocity as a function of signal frequency is *dispersion* which was previously discussed.

The signal at a point down the line represents the sum of that original signal's Fourier spectrum. Because both the attenuation and propagation velocity of these Fourier components increase with frequency, the resultant signal shape at that point down the line depends greatly on the winners of the race to get to that point. The high frequency components, with their faster propagation velocities, arrive first, but the increased attenuation minimizes their effect. The low frequency signals arrive later, but the reduced attenuation allows them a greater influence on the resultant signal. In general, the output signal from the line should show a relatively fast rise up to some signal value (20% to 50% of the final value). This is due to arrival of the high frequency components, followed by a more leisurely rise to the final value as the slower, low frequency components arrive.

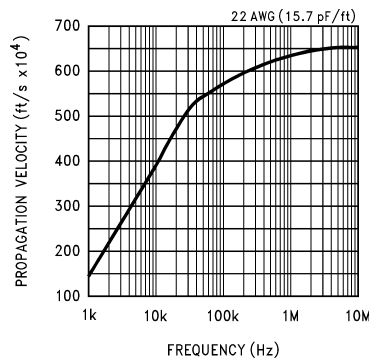

Figure 6. Propagation Velocity vs Frequency

6 Signal Quality—Terms

Before the concepts presented in the previous sections can be used to answer the “how far—how fast” question, some familiarity with the terms describing data and signal quality is necessary.

The primary objective of data transmission is the transfer of *information* from one location to another. The information here is *digital* in nature; i.e., a finite number of separate states or choices. This is in contrast to *analog* which has an infinite number of separate states or a continuous range of choices. The digital information is *binary* or two-valued; thus two different, recognizable electrical states/levels are used to symbolize the digital information. A binary symbol is commonly called a binary-digit or *bit*. A single binary symbol or bit, by itself, can represent only one of two possible things. To represent alphabetic or numeric characters, a group of bits is arranged to provide the necessary number of unique combinations. This arrangement of bits which is then considered an information unit is called a *byte*. In the same manner that a group of bits can be called a byte, a collection of bytes, considered as a unit, is called a *word*. Selective arrangement of seven bits will provide 2^7 (or 128) distinct character combinations (unique bytes). The American Standard Code for Information Interchange (ASCII) is an excellent example of just such an arrangement—upper and lower case alphabetic, zero to nine numeric, punctuation marks, and miscellaneous information-code control functions.

Now with the means for representing information as bits or bytes, and the means for transmission of the bits (symbols) from one location to another (transmission line), the remaining task is to ensure that a particular bit arriving at its destination is interpreted in the proper context. To achieve this, both the sender and receiver of the data must accomplish the five following requirements.

1. Agree upon the nominal rate of transmission; or how many bits are to be emitted per second by the sender.
2. Agree upon a specified information code providing a one-to-one mapping ratio of information-to-bit pattern and vice versa.
3. Establish a particular scheme whereby each bit can be properly positioned within a byte by the receiver of the data (assuming that bit-serial transmission is used).
4. Define the protocol (handshaking) sequences necessary to ensure an orderly flow of information.
5. Agree to the electrical states representing the logic values of each bit and the particular pulse code to be used.

These are by no means all of the points that must be agreed upon by sender and receiver—but these are probably the most important. Items 2, 3 and 4 are more or less “software” type decisions, because the actual signal flow along the transmission line is usually independent of these decisions. Because items 1 and 5 are much more dependent on the characteristics of line drivers, line receivers, and transmission lines, they are the primary concern here.

Figure 7 represents the components of a typical data transmission system. The *information source* can be a computer terminal or a digitized transducer output, or any device emitting a stream of bits at the rate of one bit every t_b seconds. This establishes the *information rate* of the system at $1/t_b$ bits per second. The information source in the figure feeds a *source encoder* which performs logic operations not only on the data, but also on the associated clock and, perhaps, the past data bits. Thus, the source encoder

produces a binary data stream controlling the *line driver*. The line driver interfaces the source internal logic levels (TTL, CMOS, etc.) with transmission line current/voltage requirements. The transmission line conveys signals produced by the line driver to the line receiver. The line receiver makes a decision on the signal logic state by comparing the received signal to a decision threshold level, and the *sink decoder* performs logic operations on the binary bit stream recovered by the line receiver. For example, the sink decoder may extract the clock rate from the data or perhaps detect and correct errors in the data. From the optional sink decoder, the recovered binary data passes to the *information sink*—the destination for the information source data.

Assume for the moment that the source encoder and sink decoder are “transparent”; that is, they will not modify the binary data presented to them in any way. Line driver signals, then, have the same timing as the original bit stream. The data source emits a new bit every t_b seconds. The *pulse code* produced by the source encoder and line driver is called Non-Return to Zero (NRZ), a very common signal in TTL logic systems. A sample bit pattern with its NRZ representation is shown in [Figure 8](#). The arrows at the top represent the *ideal instants*, or the times the signal can change state. The term *unit interval* is used to express the time duration of the shortest signaling element. The shortest signaling element for NRZ data is one bit time t_b , so the unit interval for NRZ data is also t_b . The rate at which the signal changes is the *modulation rate* (or signaling speed), and *baud* is the unit of modulation rate. A modulation rate of one baud corresponds to the transmission of one unit interval per second. Thus the modulation rate, in baud, is just the reciprocal of the time for one unit interval. A unit interval of 20 ms, therefore, means the signaling speed is 50 baud. The reason for differentiating between the *information rate* in bits per second (bps) and the *modulation rate* in baud will be clarified after examining some of the other pulse codes later in this application note.

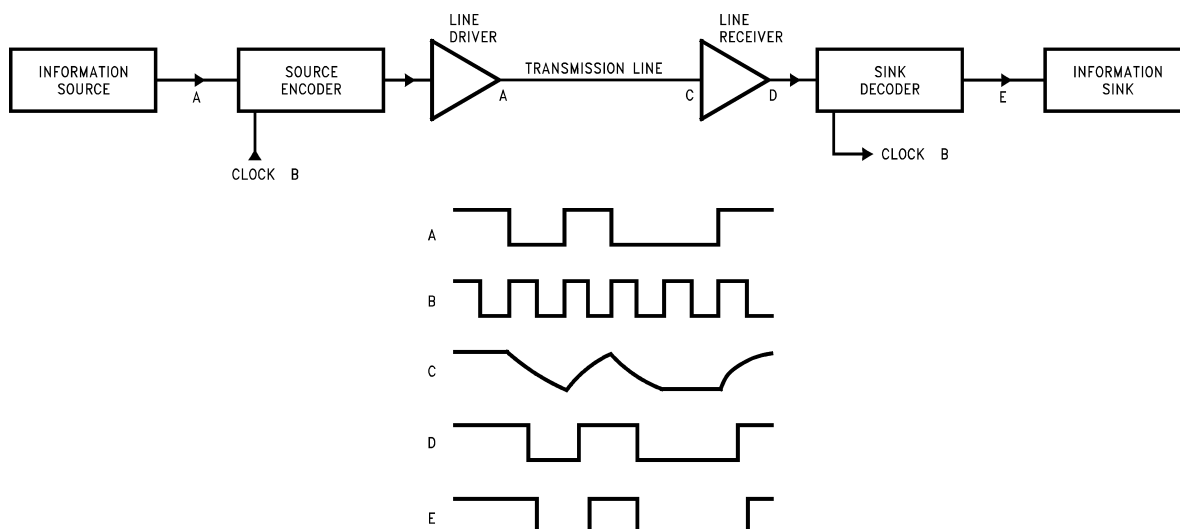

Figure 7. Data Transmission System

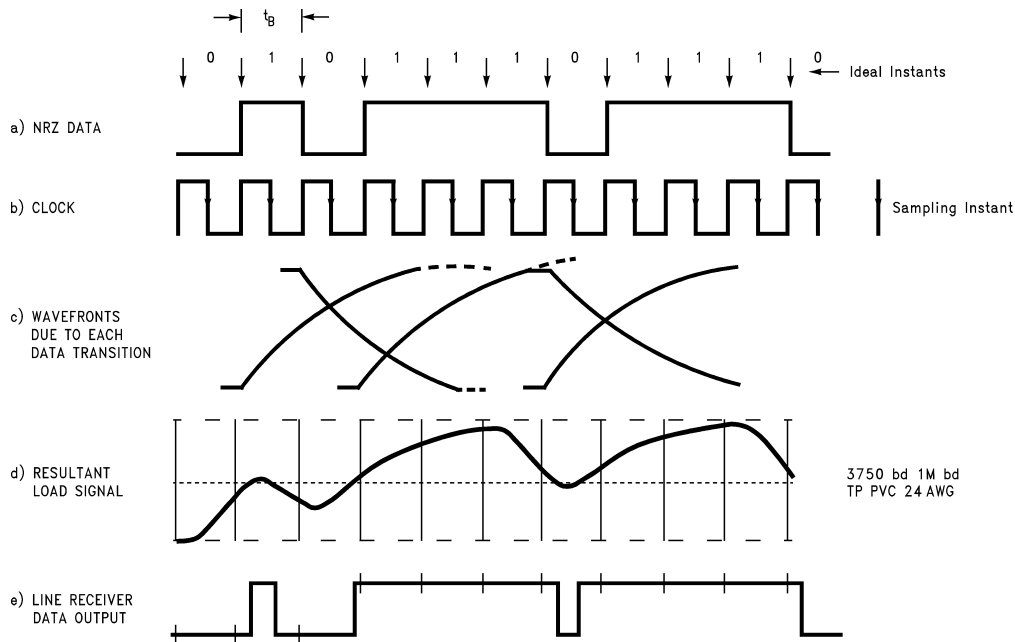

Figure 8. NRZ Signaling

NRZ data should always be accompanied by a clock signal, [Figure 8](#), which tells the receiver when to sample the data signal and thus determine the current logic state. For the example in [Figure 8](#), the falling edge of the clock corresponds to the middle of the data bits, so it could be used to transfer the line receiver data output into a binary latch. The falling edge of the clock is thus the *sampling instant* for the data. The line receiver does have a *decision threshold* or slicing point so that voltages above that threshold level produce one logic state output, while voltages below the threshold produce the other logic state at the receiver output. The receiver may incorporate positive feedback to produce *hysteresis* in its transfer function. This reduces the possibility of oscillation in response to slow rise or fall time signals applied to the receiver inputs.

Previously in this application note, it was stated that the fast rise and fall times of signals, corresponding to the transitions between data bits, are rounded out and slowed down by a real transmission line. Each transition of the signal applied to the line by the line driver is transformed to a rounded out transition by the dispersion and attenuation of the transmission line. The resultant signal at the load end of the line consists of the superposition of these transformed transitions. The waves arriving at the load end of the line are shown in [Figure 8](#) and their superposition is shown in [Figure 8](#). It is assumed that the line is terminated in its characteristic resistance so that reflections are not present. The receiver threshold level is shown here, superimposed on the resultant load signal, and the re-converted data output of the line receiver is shown in [Figure 8](#) along with the ideal instants for the data transitions (tick marks).

Comparing the original data ([Figure 8](#)) to the recovered data ([Figure 8](#)) shows that the actual recovered data transitions may be displaced from their ideal instants (tic marks on [Figure 8](#)). This time displacement of the transitions is due to a new wave arriving at the receiver site before the previous wave has reached its final value. Since the wave representing a previous data bit is *interfering* with the wave representing the present data bit, this phenomenon is called *intersymbol interference* (in telegraphy it is called *characteristic distortion*). The intersymbol interference can be reduced to zero by making the unit interval of the data signal quite long in comparison to the rise/fall time of the signal at the receiver site. This can be accomplished by either reducing the modulation rate for a given line length, or by reducing the line length for a given modulation rate.

Signal quality is concerned with the variance between the ideal instants of the original data signal and the actual transition times for the recovered data signal.

For synchronous signaling, such as NRZ data, the *isochronous distortion* of the recovered data is the ratio of the unit interval to the maximum measured difference irrespective of sign between the actual and theoretical significant instants. The isochronous distortion is, then, the peak-to-peak time jitter of the data signal expressed as a percentage of the unit interval. A 25% isochronous distortion means that the peak-to-peak time jitter of the transition is 0.25 unit interval (max).

Another type of received-signal time distortion can occur if the decision threshold point is misplaced from its optimum value. If the receiver threshold is shifted up toward the *One signal level*, then the time duration of the One bits shortens with respect to the duration of the *Zero bits*, and vice versa. This is called *bias distortion* in telegraphy and can be due to receiver threshold offset (bias) and/or asymmetrical output levels of the driver. These effects are shown in [Figure 9](#).

Bias distortion and characteristic distortion (intersymbol interference) together are called systemic distortion, because their magnitudes are determined by characteristics within the data transmission system. Another variety of time distortion is called *fortuitous distortion* and is due to factors outside the data transmission system such as noise and crosstalk, which may occur randomly with respect to the signal timing.

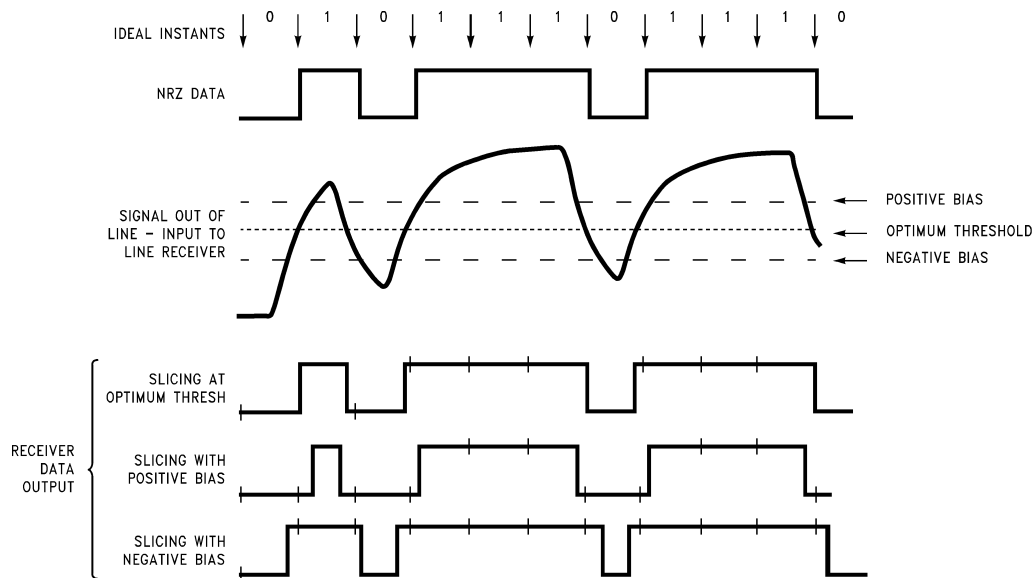

Figure 9. Bias Distortion

7 Signal Quality Measurement—The Eye Pattern

To examine the relative effects of intersymbol interference on random NRZ data and a “dotting” pattern, see [Figure 10](#). The top two waveforms represent the NRZ data and dotting pattern as outputs into two identical long transmission lines. The middle two traces illustrate the resultant signals at the line outputs and the bottom two traces show the data output of the line receivers. The respective thresholds are shown as dotted lines on the middle two traces. The arrows indicate the ideal instants for both data and dotting signals.

Notice that the dotting signal (D) is symmetrical, i.e., every One is preceded by a Zero and vice versa, while the NRZ data is random. The resultant dotting signal out of the line is also symmetrical. Because, in this case, the dotting halfcycle time is less than the rise/fall time of the line, the resultant signal out of the line (E) is a *partial response*—it never reaches its final level before changing. The dotting signal, due to its symmetry, does not show intersymbol interference in the same way that a random NRZ signal does. The intersymbol interference in the dotting signal shows up as a uniform displacement of the transitions as shown in [Figure 10](#). The NRZ data shows intersymbol interference, in its worst light, due to its unpredictable bit sequence. Thus, whenever feasibility of a data transmission system is to be tested, a random data sequence should be used. This is because a symmetrical dotting pattern or clock signal cannot always show the effects of possible intersymbol interference.

NOTE: *The term dotting pattern is from telegraphy and means an alternating sequence of 1 bits and 0 bits (the “dot dot dot” etc). Note that an NRZ dotting pattern generates a signal which has a 50% duty cycle and a frequency of $\frac{1}{2} t_b$ (Hz).

A very effective method of measuring time distortion through a data transmission system is based on the eye pattern. The eye pattern, displayed on an oscilloscope, is simply the superposition—over one unit interval—of all the Zero-to-One and One-to-Zero transitions, each preceded and followed by various combinations of One and Zero, and also constant One and Zero levels. The name *eye pattern* comes from the resemblance of the open pattern center to an eye. The diagrammatic construction of an eye pattern is shown in Figure 11. The data sequence can be generated by a pseudo-random sequence generator (PRSG), which is a digital shift register with feedback connected to produce a maximum length sequence.

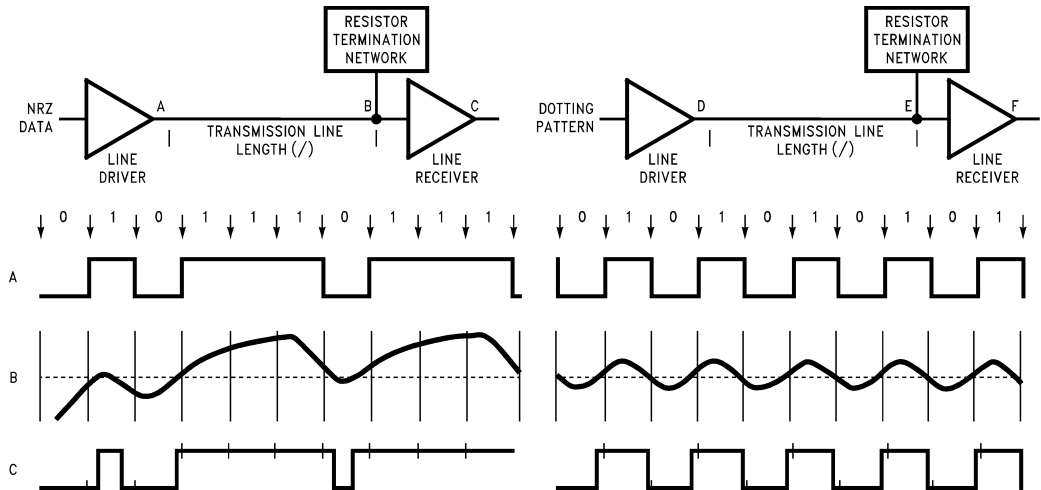

Figure 10. Comparison of NRZ Random Data and “Dotting” Signals

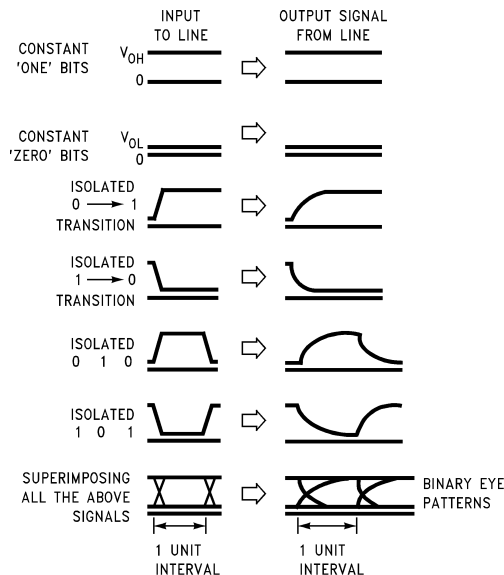
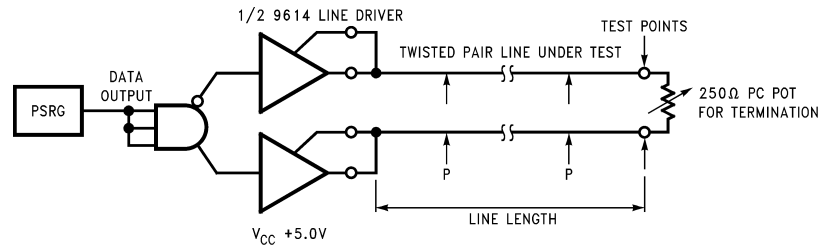
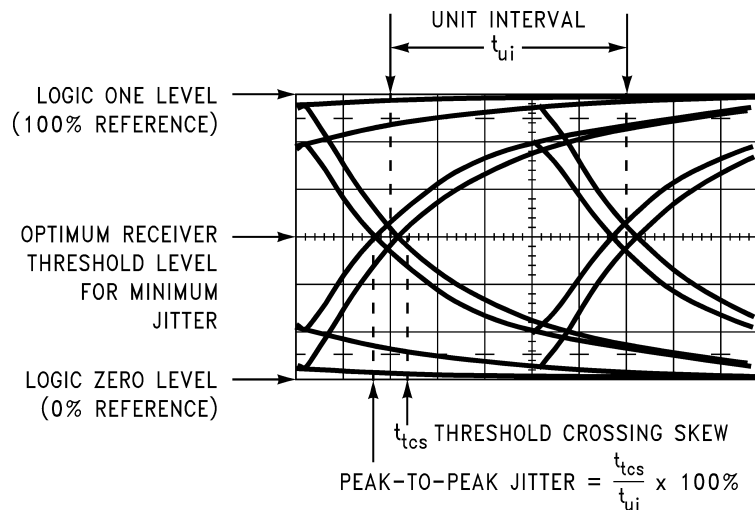

Figure 11. Formation of an Eye Pattern by Superposition



USE DIFFERENTIAL PROBE ACROSS TEST POINTS AND WIDE BANDWIDTH DIFFERENTIAL INPUT OSCILLOSCOPE TO DISPLAY EYE PATTERN.

Figure 12. Bench Set-Up to Measure Data Signal Quality



2100 ft—Terminated
24 AWG Twisted Pair
Cable—PVC Insulation

Figure 13. NRZ Data Eye Pattern

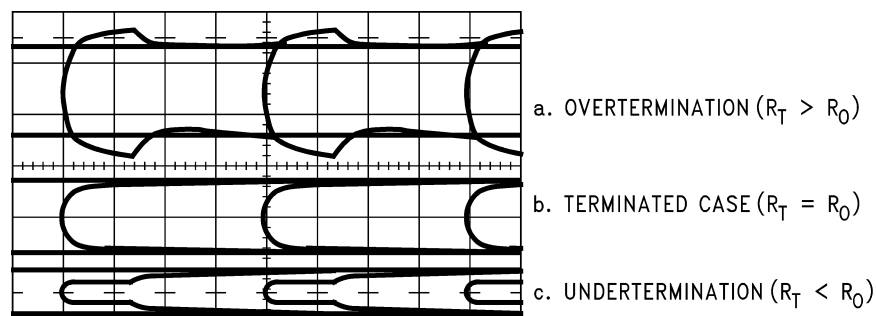

Figure 14. Using Eye Pattern to Determine Characteristic Resistance of Line

Several features of the eye pattern make it a useful tool for measuring data signal quality. Figure 14 shows a typical binary eye pattern for NRZ data. The spread of traces crossing the receiver threshold level (dotted line) is a direct measure of the peak-to-peak transition jitter—*isochronous distortion* in a synchronous system—of the data signal. The rise and fall time of the signal can be conveniently measured by using the built-in 0% and 100% references produced by long strings of Zeros and Ones. The

height of the trace above or below the receiver threshold level at the sampling instant is the noise margin of the system. If no clear transition-free space in the eye pattern exists, the eye is closed. This indicates that error-free data transmission is not possible at the data rate and line length with that particular transmission line without resorting to equalizing techniques. In some extreme cases, error-free data recovery may not be possible even when using equalizing techniques.

The eye pattern can also be used to find the characteristic resistance of a transmission line. The 250 Ω printed circuit-type potentiometer termination resistor ([Figure 12](#)) can be adjusted to yield the minimum overshoot and undershoot of the data signal. [Figure 15](#) shows the NRZ data eye patterns for $R_T > R_O$, $R_T = R_O$ and $R_T < R_O$. The 100% and 0% reference levels are again provided by long strings of Ones and Zeros, and any overshoot or undershoot is easily discernible. The termination resistor is adjusted so that the eye pattern transitions exhibit the minimum perturbations ([Figure 14](#)). The resistor is then removed from the transmission line, and its measured value is the characteristic resistance of the line.

By using the eye pattern to measure signal quality at the load end of a given line, a graph can be constructed showing the tradeoffs in signal quality—peak-to-peak jitter—as a function of line length and modulation rate for a specific pulse code. An example graph for NRZ data is shown in [Figure 15](#). The graph was constructed using eye pattern measurements on a 24 AWG twisted pair line (PVC insulation) driven by a differential voltage source driver (75114/9614) with the line parallel-terminated in its characteristic resistance (96 Ω). The oscilloscope plots in [Figure 16](#) show the typical eye patterns for NRZ data with various amounts of isochronous distortion. The straight lines represent a “best fit” to the actual measurement points. Since the twisted pair line used was not specifically constructed for pulse service, the graph probably represents a reasonably good worst-case condition insofar as signal quality vs line length is concerned. Twisted pair lines with polyethylene or Teflon insulation have shown better performance at a given length than the polyvinyl chloride insulation. Likewise, larger conductors (20 AWG, 22 AWG) also provide better performance at a given length. Thus, the graph in [Figure 15](#) can be used to estimate feasibility of a data transmission system when the actual cable to be used is unavailable for measurement purposes. The arbitrary cutoff of 4000 feet on the graph was due to the observed signal amplitude loss of 6 dBV ($\frac{1}{2}$ voltage) of the 24 AWG line at that distance. The cutoff of 10 Mbaud is based on the propagation delays of the typical TTL line drivers and receivers. Field experience has shown that twisted pair transmission systems using TTL drivers and receivers have operated essentially error-free when the line length and modulation rate are kept to within the recommended operating region shown in [Figure 15](#). This has not precluded operation outside this region for some systems, but these systems must be carefully designed with particular attention paid to defining the required characteristics of the line, the driver, and the receiver devices. The use of coaxial cable instead of twisted pair lines almost always yields better performance, i.e., greater modulation rate at a given line length and signal quality. This is because most coaxial cable has a wider bandwidth and reduced attenuation at a given length than twisted pair line (one notable exception is RG 174/U cable).

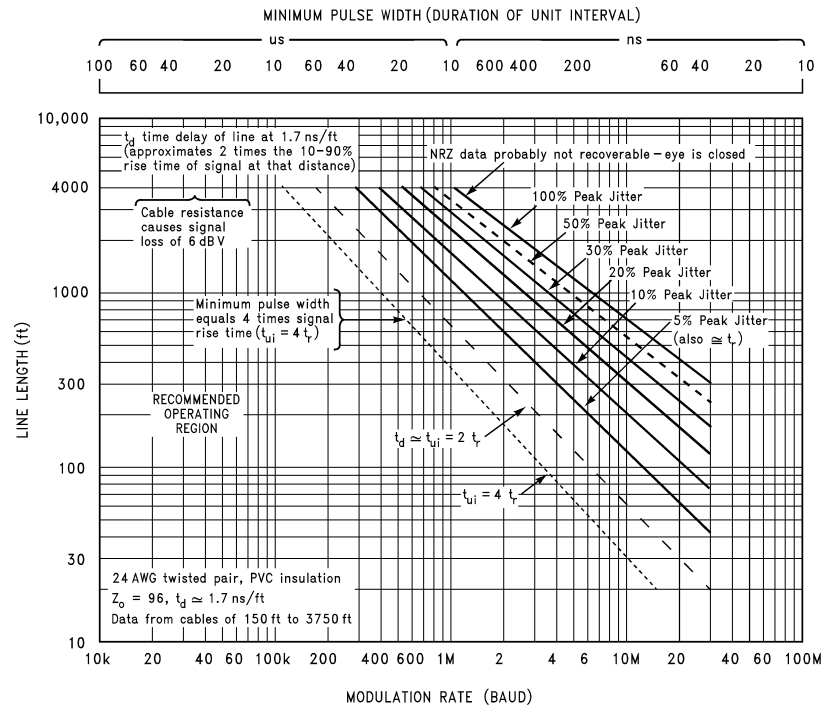

Figure 15. Signal Quality as a Function of Line Length and Modulation Rate for Terminated 24 AWG Twisted Pair (PVC Insulation)

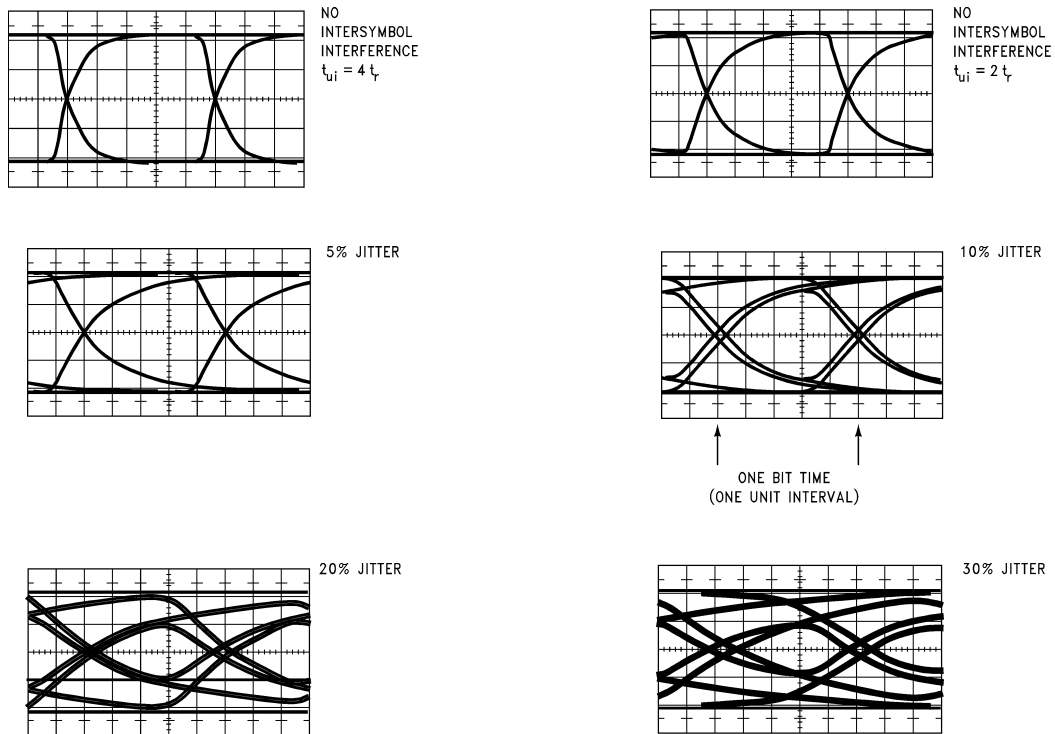



Figure 16. Eye Patterns for NRZ Data Corresponding to Various Peak-to-Peak Transition Jitter

It should be remembered that, in some ways, the eye pattern gives the *minimum* peak-to-peak transition jitter for a given line length, type, pulse code, and modulation rate. This is because the eye pattern transition spread is the result of intersymbol interference and reflection effects (if present) and this minimum jitter is only obtainable if the following conditions are met.

- The One and Zero signal levels produced by the line driver are symmetrical, and the line receiver's decision threshold (for NRZ signaling) is set to coincide with the mean of those two levels.
- The line is perfectly terminated in its characteristic resistance to prevent reflections from altering the signal threshold crossings.
- The time delays through driver and receiver devices for both logic states is symmetrical and there is no relative skew in the delays (difference between t_{ph} and t_{pnl} propagation delays = 0). This is especially important when the device propagation delays become significant fractions of the unit interval for the applicable modulation rate.

If any one of these conditions is not satisfied, the signal quality is reduced (more distortion). The effects of receiver bias or threshold ambiguity and driver offset can be determined by location of the decision threshold(s) on the oscillograph of the eye pattern for that driver/cable modulation rate combination. For eye patterns displaying more than 20% isochronous distortion, the slope of the signal in the transition region is relatively small. Therefore, a small amount of bias results in a large increase in net isochronous distortion. See [Figure 17](#) for a graphic illustration of this effect. In the interest of conservative design practices, systems should always be designed with less than 5% transition spread in the eye pattern. This allows the detrimental effects due to bias to be minimized, thus simplifying construction of line drivers and receivers.

8 Other Pulse Codes and Signal Quality

In the preceding sections, the discussion of signal quality has been centered around the use of NRZ signaling, because it represents the simplest and most commonly used pulse code. Other pulse codes have been developed which provide one or more of the following desirable features:

- Compress the overall bandwidth normally required to adequately transmit the signal yet still ensure recovery of the binary data.
- Eliminate the need for a dc response in the transmission medium so that transformer coupling can be used for phantom power distribution on repeated lines. (The elimination of a dc characteristic of the pulse code also allows ac coupling of amplifier circuits).
- Provide a clocking scheme within the signal so that no separate clock channel is required for synchronization.
- Provide built-in error detection.

The following discussion is restricted to the binary class of baseband signals. This simply means that each decision by the line receiver yields one bit of information. The M -ary schemes ($M \geq 3$) can encode more than one bit of information per receiver decision*, but these schemes are seldom applied to baseband signaling due to the complexities of the driver and receiver circuits (especially for $M > 3$). M -ary schemes, however, are applied to high speed non-baseband data transmission systems using modems. The price to be paid for the increased bit-packing with multi-level signaling is decreased immunity to noise relative to a binary system. This is because a smaller relative threshold displacement (or amount of noise) is required to produce a signal representing another logic state in the M -ary schemes.

NOTE: *It can be shown that, for M levels, the information per receiver decision will be $S = \log_2 M$ bits/decision. Thus, three levels theoretically yield 1.58 bits; four levels yield 2 bits of information, eight levels yield 3 bits, etc.

In general, the binary class of pulse codes can be grouped into four categories:

- Non-Return to Zero (NRZ)
- Return to Zero (RZ)
- Phase Encoded (PE) (sometimes called Split Phase)
- Multi-Level Binary (MLB). (The MLB scheme uses three levels to convey the binary data, but each decision by the line receiver yields only one bit of information.)

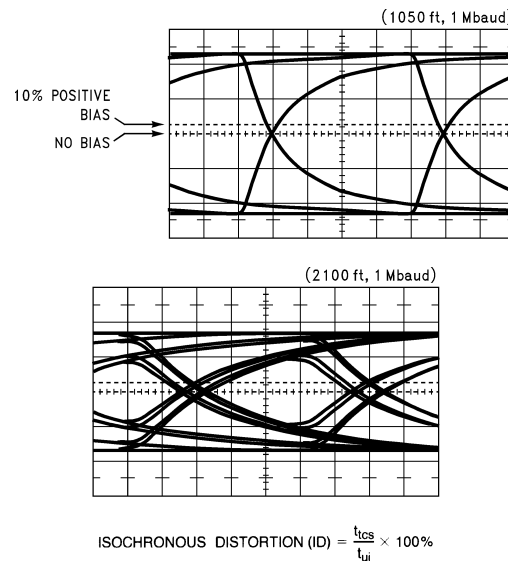

Figure 17. Receiver Bias Effect on Total Isochronous Distortion

		1050 ft	2100 ft
BIAS	0%	5% ID	20% ID
	10%	12% ID	36% ID

A secondary differentiation among the pulse codes is concerned with the algebraic signs of the signal levels. If the signal levels have the same algebraic sign for their voltages (or currents) and differ only in their magnitudes, the signaling is called *unipolar*. A very common example of unipolar signaling is TTL or ECL logic. TTL uses two positive voltages to represent its logic states, while ECL uses two negative voltages for its logic states. The complement of unipolar signaling is *polar* signaling. Here, one logic state is represented by a signal voltage or current having a positive sign and the other logic state is represented by a signal with a negative sign. For binary signals, the magnitude of both signals should be equal, ideally. Their only difference should be in the algebraic signs. This allows the receiver to use ground as its decision threshold reference.

8.1 NON-RETURN TO ZERO (NRZ) PULSE CODES

There are three NRZ pulse codes: NRZ-Level (NRZ-L), NRZ-Mark (NRZ-M), and NRZ-Space (NRZ-S). NRZ-L is the same pulse code as previously discussed. In NRZ-L signaling, data is represented by a constant signal level during the bit time interval, with one signal level corresponding to one logic state, and the other signal level corresponding to the opposite logic state. In NRZ-M or NRZ-S signaling, however, a change in signal level at the start of a bit interval corresponds to one logic state and no change in signal level at the start of a bit interval corresponds to the opposite logic state. For NRZ-M pulse codes, a change in signal level at the start of the bit interval indicates a logic One (Mark), while no change in signal level indicates a logic Zero (Space). NRZ-S is a logical complement to NRZ-M. A change in signal level

means a logic Zero and no change means logic One. With NRZ-M and NRZ-S pulse codes, therefore, there is no direct correspondence between signal levels and logic states as there is with NRZ-L signaling. Any of the NRZ pulse codes may, of course, be used in unipolar or polar form. The NRZ codes are shown in Figure 18, along with their generation algorithm*, signal levels vs time, and their general power density spectrum.

NOTE: *The generation algorithm showing the sequence of signal levels on the line, represented by the set $\{b_n\}$, is determined by the sequence of input logic states, represented by the set $\{a_n\}$. See Bennet¹⁴ for detailed usage of this notation.

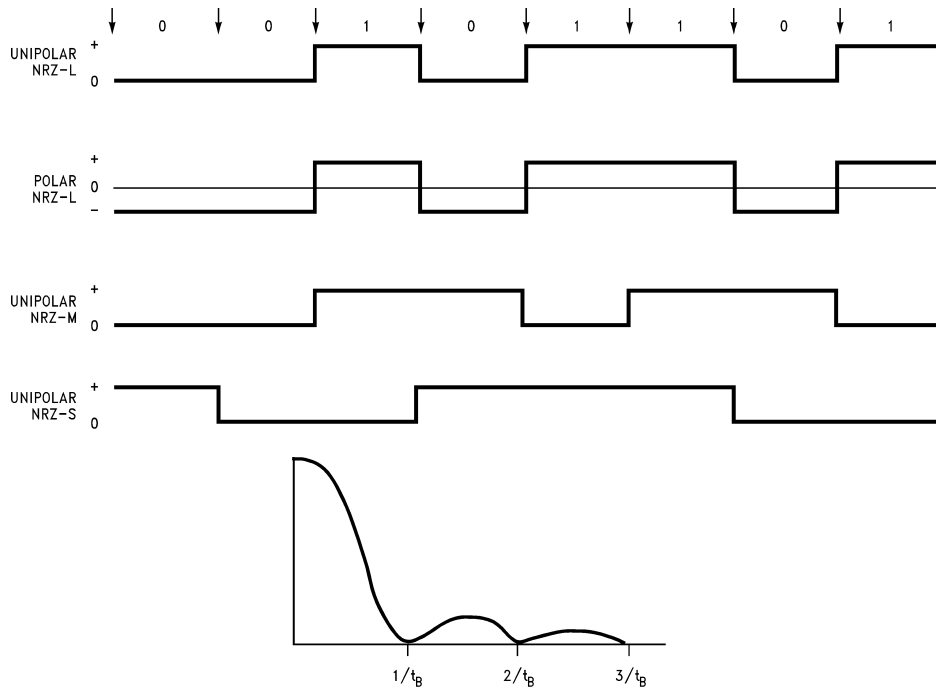

GENERAL POWER SPECTRUM FOR NRZ CODES

DATA TO BE SENT a_n	LINE SIGNAL SEQUENCE (b_n)			
	UNIPOLAR NRZ-L	POLAR NRZ-L	UNIPOLAR NRZ-M	UNIPOLAR NRZ-S
1	+ 0 —————	+ 0 —————	+ 0 ————— + OR 0 —————	+ 0 ————— + OR 0 —————
0	+ 0 —————	0 - —————	+ 0 ————— + OR 0 —————	+ 0 ————— + OR 0 —————
	← t_B →	← t_B →	← t_B →	← t_B →

Figure 18. Non-Return to Zero (NRZ) Pulse Codes

t_{ui}	t_B	t_B	t_B	t_B
$a_n = 1$	$b_n = +$	$b_n = +$	$b_n = (-) b_n - 1$	$b_n = b_n - 1$
$a_n = 0$	$b_n = 0$	$b_n = -$	$b_n = b_n - 1$	$b_n = (-) b_n - 1$

The degradation in signal quality caused by intersymbol interference for NRZ-L signaling was discussed earlier. Since the minimum signaling element (unit interval) for all three NRZ pulse codes is equal to t_b , the previous signal quality discussion for NRZ-L also applies equally to NRZ-M and NRZ-S pulse codes. The following is a capsule summary of the previous discussion on NRZ signal quality.

- When t_b is less than the 0%–50% rise or fall time of the signal at the line end, the open space in the eye pattern closes, thereby indicating error-free data transmission is unlikely.
- When t_b is less than the 10%–90% rise or fall time of the line end signal, some intersymbol interference is present and thus, some time jitter in the transitions of the recovered data will be present.

NRZ codes are simple to generate and decode because no precoding or special treatment is required. This simplicity makes them probably the most widely used pulse codes, with NRZ-L the leader by far. NRZ-M has been widely used in digital magnetic recording where it is usually called NRZI for Non-Return to Zero, Invert-on-Ones. In terms of the four desirable features for a pulse code listed at the start of this section, however, non of the NRZ codes are all that great—NRZ codes do possess a strong dc component, and have neither intrinsic clocking, nor error detection features. Even so, their power frequency spectra are used as references for comparison with other pulse codes.

8.2 RETURN TO ZERO (RZ) PULSE CODES

The RZ group of pulse codes are usually simple combinations of NRZL data and its associated single or double frequency clock. By combining the clock with data, all RZ codes possess some intrinsic synchronization feature. Three representative RZ pulse codes are shown in Figure 19. Unipolar RZ is formed by performing a logic AND between the NRZ-L data and its clock. Thus a logic Zero is represented by the absence of a pulse during the bit time interval, and a logic One is represented by a pulse as shown. Pulse Position Modulation (PPM) uses a pulse of $t_b/4$ duration beginning at the start of the bit interval to indicate a logic Zero, and a $t_b/4$ pulse beginning at the middle of the bit interval to indicate a logic One. Pulse Duration Modulation (PDM) uses a $t_b/3$ duration pulse for a logic Zero and a $(2/3)t_b$ pulse for a logic One, with the rising edge of both pulses coinciding with the start of the bit interval. PDM with $t_b/4$ pulse widths is also used but better results are usually obtained with the $t_b/3, 2t_b/3$ scheme.

The reason for differentiating between information rate and modulation rate can now be further clarified. Each of the RZ pulse codes in Figure 19 has the same information rate; i.e., $1/t_b$ bits per second. Their respective minimum signaling elements (unit intervals) however, are all less than t_b so the *modulation rate* for the RZ pulse code is greater than the *information rate*. Remember that with NRZ signaling, the unit interval and the bit time interval are equal in duration, so the information rate in bps is equal to the modulation rate in bauds. For isochronous NRZ signaling, the measures bps and baud are both synonymous and interchangeable.

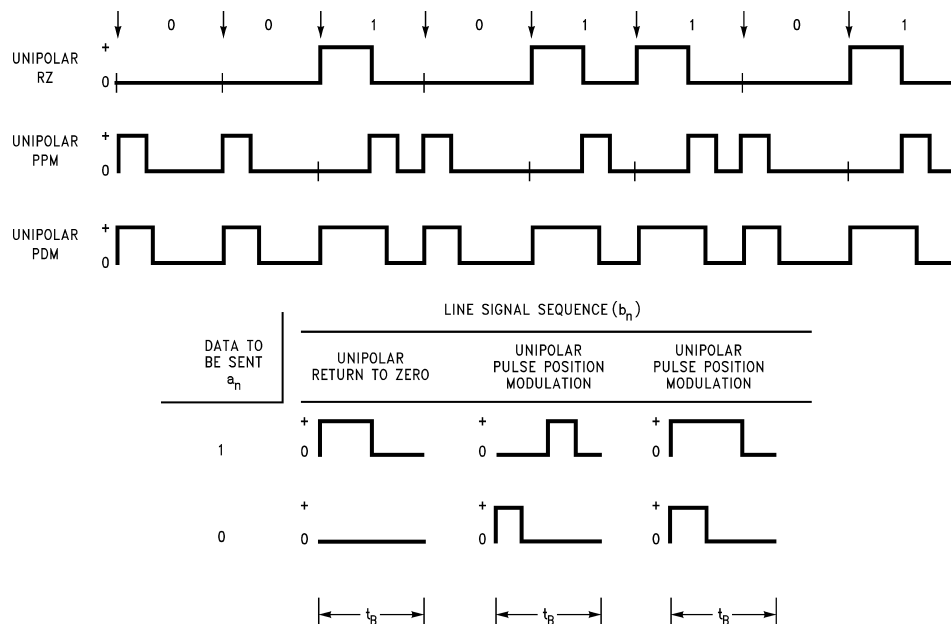

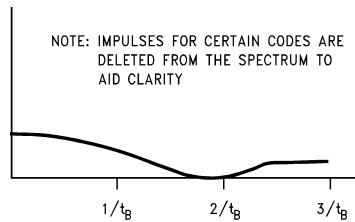

GENERAL POWER SPECTRUM FOR RZ CODES

Figure 19. Return to Zero (RZ) Pulse Codes

t_{ui}	$t_B/2$	$t_B/4$	$t_B/3$
$a_n = 1$	$b_n = (+) \{0 \leq t < t_B/2\}$ $b_n = (0) \{t_B/2 \leq t < t_B\}$	$b_n = (+) \{t_B/2 \leq t \leq 3t_B/4\}$ $b_n = (0) \begin{cases} 0 \leq t < t_B/2 \\ 3t_B/4 < t < t_B \end{cases}$	$b_n = (+) \{0 \leq t \leq 2t_B/3\}$ $b_n = (0) \{2t_B/3 \leq t < t_B\}$
$a_n = 0$	$b_n = (0)$	$b_n = (+) \{0 \leq t \leq t_B/4\}$ $b_n = (0) \{t_B/4 < t < t_B\}$	$b_n = (+) \{0 \leq t \leq t_B/3\}$ $b_n = (0) \{t_B/3 \leq t \leq t_B\}$

(15)

Inspection of unipolar RZ signaling reveals that the unit interval is $\frac{1}{2}$ bit interval ($t_{ui} = t_B/2$). When this unit interval is less than the 0%–50% rise or fall time of the line, the data is likely to be unrecoverable. With a fixed modulation rate, the price paid to include clocking information into unipolar RZ is reduced information rate over that for NRZ signaling. Likewise, for PPM with its unit interval of $t_B/4$, the information rate reduces to $\frac{1}{4}$ that of NRZ data under the same conditions. This is because the maximum modulation rate is determined by the 50% rise time of the line which is constant for a given length and type of line. PDM has a unit interval of $t_B/3$ so, for a given maximum modulation rate, the resulting information rate is $\frac{1}{3}$ that of NRZ data.

The preceding argument should not be taken as strictly correct—since the actual intersymbol interference patterns for the three RZ codes discussed differ somewhat from the pattern with NRZ codes. A random sequence of NRZ data can easily consist of a long sequence of Zeros followed by a single One and then a long sequence of Zeros, so the $t_{50\%}$ limit can be accurately applied. Unipolar RZ, in response to the same long data sequence, produces a $t_B/2$ pulse, so the $t_{50\%}$ argument can be applied here too. With PPM and PDM, the maximum time that the line signal can be in one state is quite reduced from the NRZ case. For PPM, this time is $1.25 t_B$ (010 data sequence) while for PDM, it is $0.67 t_B$ (see Figure 19). With PPM and PDM, then, the line signal may never reach the final signal levels that it does with NRZ data. So, the PPM and PDM signals have a head start, so to speak, in reaching the threshold crossing of the receiver. Because of the reduced time that PDM and PPM signal levels are allowed to remain at one signal level, their signaling may still operate at a modulation rate slightly above that where the NRZ data shows 100% transition jitter. Even with this slight correction to the previous discussion, the RZ group of pulse codes still sacrifice information rate in return for synchronization. The PPM scheme appears to be a poor trade in this respect, since PDM allows a greater information rate while retaining the self-clocking feature. Unipolar RZ, because it provides no clocking for a logic Zero signal, is not generally as useful as PDM for baseband data transmission. However, unipolar RZ is used in older digital magnetic tape recorders.

Examination of RZ codes shows only one more desirable feature than NRZ codes: clocking. RZ codes still have a dc component in their power density spectrum (Figure 19) and their bandwidth is extended (first null at $2/t_B$) over that of NRZ (first null $1/t_B$). RZ codes do not have any intrinsic error detection features.

8.3 PHASE ENCODED (PE) PULSE CODES

The PE group of pulse codes uses signal level transitions to carry both binary data and synchronization information. Each of the codes provides at least one signal level transition per bit interval aiding synchronous recovery of the binary data. Simply stated, Biphas-Level (BI ϕ -L) code is binary phase shift keying (PSK) and is the result of an Exclusive-OR logic function performed on the NRZ-L data and its clock; it is further required that the resultant signal be phase coherent (i.e., no glitches). Biphas—Mark

(Bi ϕ -M) and Biphase-Space (Bi ϕ -S) codes are essentially phase coherent, binary frequency shift keying (FSK). In Bi ϕ -M, a logic One is represented by a constant level during the bit interval (one-half cycle of the lower frequency $1/(2 t_B)$), while a logic Zero is represented by one-half cycle of the higher frequency $1/t_B$. In Bi ϕ -S, the logic states are reversed from those in Bi ϕ -M. Another way of thinking of Bi ϕ -M or Bi ϕ -S is as follows.

- Change signal level at the end of each bit interval regardless of the logic state of the data.
- Change signal level at the middle of each bit interval to mean a particular logic state.

In Bi ϕ -M (sometimes call diphase), a mid-bit interval change in signal level indicates a logic One (Mark), while no change indicates a logic Zero. For Bi ϕ -S, no signal level change in the middle of the bit interval means a logic One, while a change means a logic Zero.

In Bi ϕ -L (also called Manchester Code), a positive-going transition at the middle of the bit interval means a logic Zero, while a negative-going transition there indicates a logic One.

The fourth member of the PE family is Delay Modulation (DM)^{15, 16} sometimes referred to as Miller code. Here logic One is represented by a mid-bit interval signal level change, and a logic Zero is represented by a signal level change at the end of the bit interval if the logic Zero is followed by another logic Zero. If the logic Zero is immediately followed by a logic One, no signal level transition at the end of the first bit interval is used. The waveforms encoding algorithms, and general power density spectra for the PE pulse code family are shown in [Figure 20](#).

NOTE: *Delay Modulation^{15, 16} has a maximum of $2 t_B$ without a signal level transition.

A brief inspection of the signal waveforms for the three Biphase pulse codes reveals that their minimum signaling element has a duration of one-half bit interval ($t_{ui} = t_B/2$); the longest duration of either signal level is one bit interval. Similarly, DM is seen to have a minimum signaling element of one bit interval ($t_{ui} = t_B$) and the maximum duration of either signal level is two bit intervals (produced by a 101 pattern). Biphase codes should exhibit eye closure (they would not be recoverable without equalization) when $t_{ui} \leq t_{0\%-50\%}$. So, a 50% jitter on NRZ signaling approximately corresponds to the Biphase codes non-operation point. Biphase codes, therefore, provide one-half the information rate of NRZ signals at a given maximum modulation rate. This is in exchange for synchronization information and a dc-free spectrum when used in polar form.

DM should have essentially the same intersymbol interference characteristics as NRZ, since the unit interval is the same for both codes. DM may perform slightly better than NRZ, because the maximum duration of either signal level is two bit intervals. Overall, DM is better coding scheme than the Bi ϕ . It does not require as much bandwidth as Bi ϕ and still possesses the desirable dc response and synchronization qualities.

Both Bi ϕ and DM are good choices for digital magnetic recording¹⁶; Bi ϕ is widely used in disc memory equipment, and DM is rapidly gaining acceptance where high bit packing densities are desired. Overall scoring, in terms of the four desirable characteristics, shows the PE pulse codes with three primary features; bandwidth compression, no dc, and intrinsic synchronization.

Th Bi ϕ family does not possess any intrinsic error detection scheme. DM does possess the capability of detecting some—but not all—single bit errors. This detection process is accomplished by checking to see if a single level persists longer than two bit intervals, in which case, an error is indicated. DM detection requires two samples per bit interval.

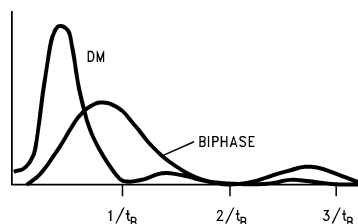

GENERAL POWER SPECTRUM
FOR SPLIT PHASE CODES

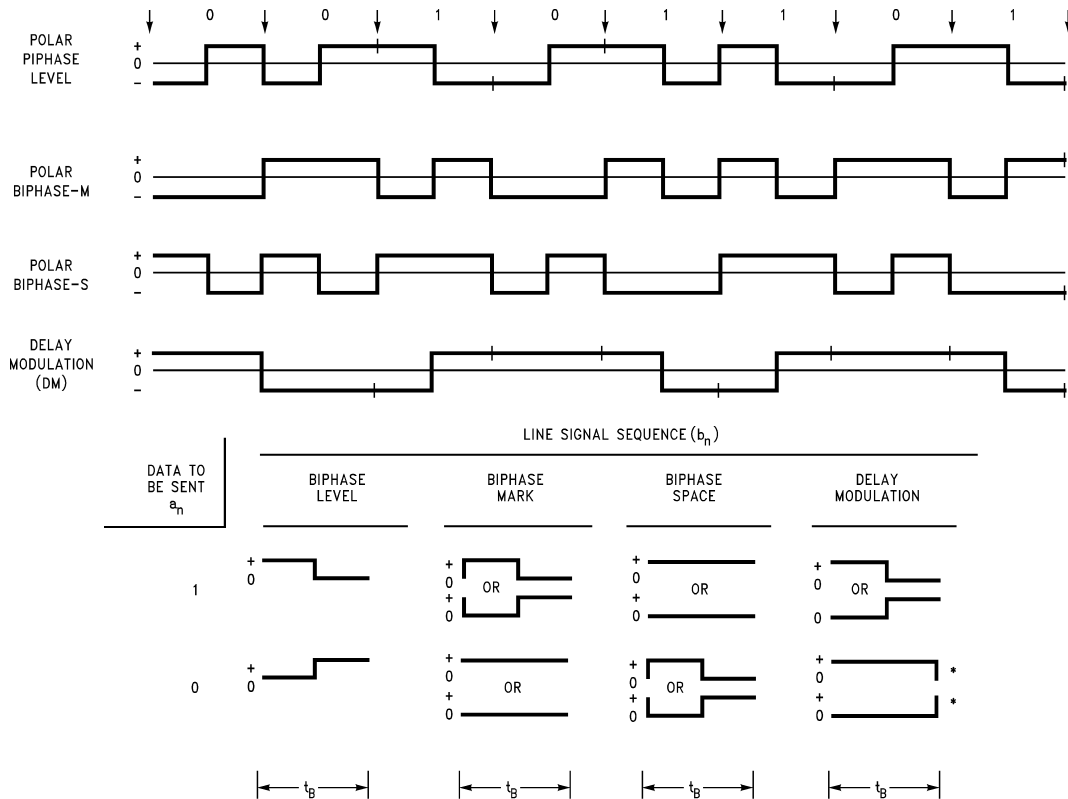

Figure 20. Phase Encoded (PE) Pulse Codes

t_{ui}	$t_B/2$	$t_B/2$	$t_B/2$	t_B
$a_n = 1$	$b_n = (+) \{0 < t < t_B/2\}$ $b_n = (-) \{t_B/2 \leq t \leq t_B\}$	‡	$b_n = (-) b_{n-1}^*$ *complement of final level of last b_n	if final value of $b_{n-1} = (+)$ then $b_n = (+) \{0 < t < t_B/2\}$ and $b_n = (-) \{t_B/2 \leq t \leq t_B\}$ else, complement above b_n values for times shown
$a_n = 0$	$b_n = (-) \{0 < t < t_B/2\}$ $b_n = (+) \{t_B/2 \leq t \leq t_B\}$	$b_n = (-) b_{n-1}^*$ *complement of final level of last b_n	‡	if final value of $b_{n-1} = (+)$ then $b_n = (+) \{0 \leq t < t_B\}$ if $a_{n+1} = (0)$ then $b_n = (-) \{t = t_B\}$ else $b_n = (+) \{t = t_B\}$ if final value of $b_{n-1} = (-)$ then complement b_n values above

‡ If b_{n-1} final level = (+), then	$b_n = (-) \{0 \leq t < t_B/2\}$ $b_n = (+) \{t_B/2 \leq t < t_B\}$
If b_{n-1} final level = (-), then	$b_n = (+) \{0 \leq t < t_B/2\}$ $b_n = (-) \{t_B/2 \leq t < t_B\}$

8.4 MULTI-LEVEL BINARY (PLB) PULSE CODES

The pulse codes in the MLB group discussed have a common characteristic of using three signal levels (expressed in shorthand notation as +, 0, -) to represent the binary information, but each receiver decision yields only one bit of information. These are sometimes called *pseudoternary* codes to distinguish them from true ternary codes wherein each receiver decision can yield 1.58 information bits.

The most straightforward pulse code in the MLB group is polar RZ (Figure 21). Some authors place PRZ in the RZ group, but since PRZ uses three signal levels, it is placed in the MLB group here. A logic One is represented by a positive polarity pulse, and a logic Zero is represented by a negative polarity pulse. Each pulse lasts for one-half bit interval. PRZ has excellent synchronization properties since there is a pulse present during every bit interval.

Bipolar (BP)^{17, 18} uses a $t_b/2$ duration pulse to signify a logic One, and no pulse during the bit interval to signify a logic Zero. The polarity of the pulses for a logic One is alternated as shown in Figure 21. Bipolar coding is also known as Alternate Mark Inversion. BP is widely used in Bell Systems T1-PCM carrier systems as a pulse code transmitted along a regenerative repeated transmission line. Since BP has no dc component, the regenerative repeaters along the span line may be transformer coupled and powered by a phantom constant current power loop from the central office. The synchronization properties of BP are excellent if the number of Zero bits transmitted in series is constrained. This constraint on the number of sequential Zeros allows clock circuits in each repeater to remain in synchronization. A scheme called Binary with 6 Zeros Substitution (B6ZS) was developed to replace 6 Zeros with a given signal sequence to offset this loss of synchronization¹⁸. Bipolar coding has a limited capability to detect single errors, all odd errors, and certain even error combinations which violate the mark alternation rule. Another scheme called High Density Bipolar with 3 Zeros substitution (HDB-3) replaces four successive Zeros (no pulses) with three Zeros followed by a pulse whose polarity violates the Mark alternation rule¹⁹. Subsequent detection of this pattern (three Zeros and pulse violating the polarity coding rule) causes the receiver to substitute four Zeros for the received 0001 pattern.

In Dicode (DI)^{20, 21}, a polar pulse (either t_b for DI-NRZ or $t_b/2$ for DI-RZ) is sent for every input data transition. The limiting constraint is that the successive pulses must alternate in sign (Figure 20). As in NRZ-M and NRZ-S, the actual polarity of the pulses does not necessarily correspond to the logic state of the data (a positive pulse may represent either a Zero-to-One or a One-to-Zero transition of the input data). The power spectrum for DI is the same as for BP (no dc component). Bit synchronization for DI can be obtained in the same manner as for BP, but with DI, the number of bits of the same logic state must be controlled in order for the receiver to maintain bit synchronization. DI also has the intrinsic capability of detecting single bit errors (via two successive positive or negative signal levels), all odd, and some even numbers of errors.

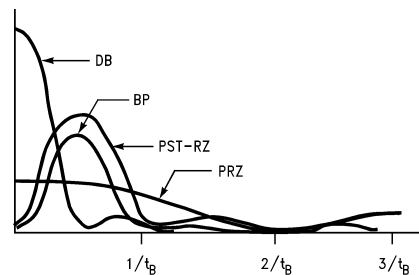

GENERAL POWER DENSITY SPECTRUM
RANDOM SEQUENCE
 $P(0) = P(1) = 0.5$

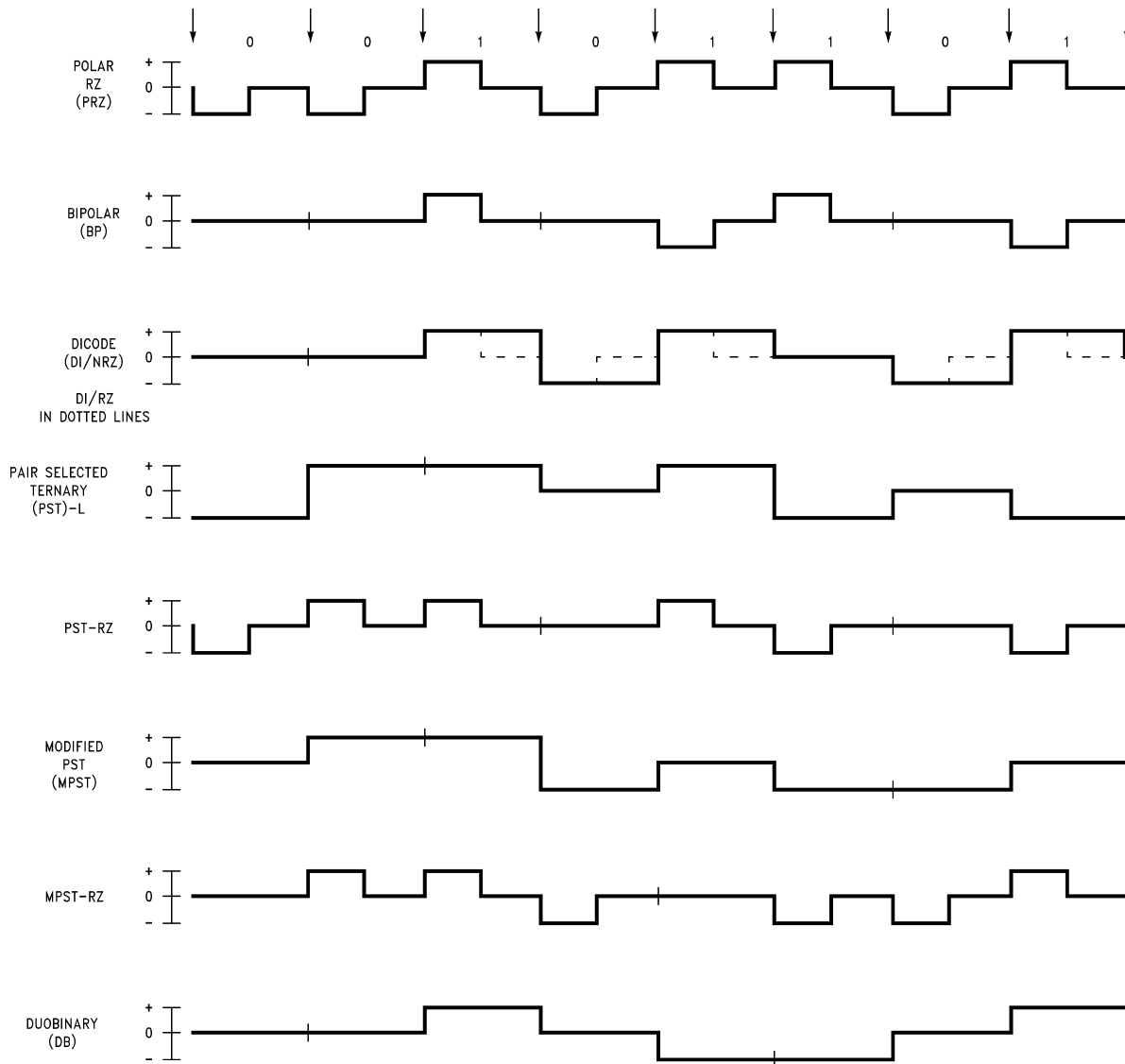

Figure 21. Multilevel Binary (MLB) or Pseudoternary Pulse Codes

Pair Selected Ternary (PST)^{18, 22} and Modified PST (MPST)²² were proposed to minimize the disadvantages of BP coding: loss of synchronization with long strings of Zeros and timing jitter. PST/MPST maintains the strong features of BP: dc free spectrum, single error detection. To produce PST or MPST, the incoming bits are grouped into pairs, and the signal produced on the line is governed by a coding table. Two modes are also used in the coding table with a change in mode occurring after a certain bit pair is transmitted. The features of PST/MPST thus include:

- No dc spectral component,
- No loss of synchronization with long strings of Zeros,
- Intrinsic error detection,
- Simplification of requirements for timing extraction circuits with respect to BP.

MPST coding was developed primarily to speed up the framing process, i.e., selecting which two successive pulses constitute a valid pair, when the probability for a Zero and a One are not equal.

Duobinary^{23, 24} is an example of a correlative level coding technique, wherein a correlation exists between successive signal levels. Duobinary uses three signal levels with the middle level corresponding to a logic Zero, and the other two levels corresponding to a logic One. The pseudoternary signal is generated by precoding the input data, which results in constraining the line signal to change only to the neighboring level, i.e., the (+) to (-) and (-) to (+) level changes are not allowed. This precoding process uses controlled intersymbol interference as part of the coding scheme. The benefit is an effective doubling of the bit rate for a given bandwidth and concentration of the power spectrum toward dc (Figure 21). Duobinary has the capability to detect single errors which violate the encoding rules. In terms of bandwidth utilization, Duobinary ranks first among all the binary and MLB codes²⁰, but its strong dc component prohibits the use of ac-coupled transmission media. Synchronization properties are similar to NRZ, thus external clocking must be used to recover the data.

9 References

1. N.S. Nahman and R.L. Wigington; "Transient Analysis of Coaxial Cables Considering Skin Effect", *IRE Proceedings*, Vol. 45, Feb. 1957, pp. 166–174.
2. N.S. Nahman; "A Discussion on the Transient Analysis of Coaxial Cables Considering High Frequency Losses", *IRE Transactions on Circuit Theory*, Vol. CT-9, No. 2, June 1962, pp. 144–152.
3. N.S. Nahman and D.R. Holt; "Transient Analysis of Coaxial Cables Using the Skin Effect Approximation $A + B\sqrt{s}$ ", *IEEE Transactions on Circuit Theory*, Vol. 19, No. 5, Sept. 1972, pp. 443–451.
4. N.S. Nahman; "A Note on the Transition (Rise) Time Versus Line Length in Coaxial Cables", *IEEE Transactions on Circuit Theory* (correspondence), Vol. CT-20, No. 2, Mar. 1973, pp. 165–167.
5. R.E. Matick; *Transmission Lines for Digital and Communications Networks*, McGraw Hill, New York, 1969.
6. G. Metzger and J.P. Vabre; *Transmission Lines with Pulse Excitation*, Academic Press, New York, 1969.
7. J.T. Koliass; "Interconnection Delays", *Digital Design*, June 1973, pp. 40–45.
8. F. Kirsten; "Pulse Response of Coaxial Cables", *Counting Handbook* (UCRL 3307 Rev.), CC2-1, Lawrence Radiation Laboratory, Jan. 1959.
9. P.C. Magnusson; "Transient Wavefronts on Lossy Transmission Lines—Effect of Source Resistance", *IEEE Transactions on Circuit Theory* (correspondence), Vol. CT-15, Sept. 1968, pp. 290–292.
10. G.L. Turin; "Steady-State and Transient Analysis of Lossy Coaxial Cables", *IRE Proceedings* (correspondence), Vol. 45, June 1957, pp. 878–879.
11. A.H.M. Arnold; "Proximity Effect in Solid and Hollow Round Conductors", *Journal IEE* (London), Vol. 88, pt. II, August 1941, pp. 349–359.
12. H.B. Dwight; "Proximity Effect in Wires and Thin Tubes", *AIEE Transactions*, Vol. 42, Sept. 1923, pp. 961–970.
13. *Standard Wire and Cable Co., Catalog*, Third Edition, Mar. 1971, pp. 62–74.
14. W.R. Bennet; *Introduction to Signal Transmission*, McGraw Hill, New York, 1970.
15. M. Hecht and A. Guida; "Delay Modulation", *Proceedings of IEEE* (letters), Vol. 57, No. 1, July 1969; pp. 1314–1316.
16. A.E. Whitehouse and L.E.M. Warburton; "Information Coding on Magnetic Drums and Discs", *IEE (London), Conference on Computer Science and Technology*, 1969, Pub. No. 55, pp. 237–245.
17. J.S. Mayo; "Pulse Code Modulation", *Electro-Technology*, Nov. 1962, pp. 88–98.
18. *Transmission Systems for Communications*, Bell Telephone Labs., 4th ed., Feb. 1970, Chapter 27, pp. 626–638.
19. J.V. Martens and E. Brading; "30-Channel Pulse Code Modulation System", *ITT Electrical Communication*, Vol. 48, No. 1 and 2, 1973, pp. 11.69–78.
20. R.C. Houts, T.A. Green; "A Comparative Analysis of Digital Baseband Signals", *Technical Report 146–102*, Communications Systems Group, Bureau of Engineering Research, University of Alabama, June 1972.
21. R.C. Houts and T.A. Green; "Comparing Bandwidth Requirements for Binary Baseband Signals", *IEEE Transactions on Communication Technology*, (correspondence) Vol. COM-21, No. 6, June 1973, pp.

776–781.

22. J.M. Sipress; “A New Class of Selected Ternary Pulse Transmission Plans for Digital Transmission Lines”, *IEEE Transactions on Communication Technology*, Vol. 13, No. 3, Sept. 1965, pp. 366–372.
23. A. Lender; “The Duobinary Technique for High Speed Data Transmission”, *IEEE Transactions on Communication Electronics*, No. 66, May 1963, pp. 214–218.
24. A. Sekey; “An Analysis of the Duobinary Technique”, *IEEE Transactions on Communication Technology*, Vol. COM-14, No. 2, Apr. 1966, pp. 126–130.
25. G.S. Eager (et. al); “Transmission Properties of Polyethylene Insulated Cables at Voice and Carrier Frequencies”, *AIEE Transactions on Communications Electronics*, Nov. 1959, pp. 618–640.

IMPORTANT NOTICE

Texas Instruments Incorporated and its subsidiaries (TI) reserve the right to make corrections, enhancements, improvements and other changes to its semiconductor products and services per JESD46, latest issue, and to discontinue any product or service per JESD48, latest issue. Buyers should obtain the latest relevant information before placing orders and should verify that such information is current and complete. All semiconductor products (also referred to herein as "components") are sold subject to TI's terms and conditions of sale supplied at the time of order acknowledgment.

TI warrants performance of its components to the specifications applicable at the time of sale, in accordance with the warranty in TI's terms and conditions of sale of semiconductor products. Testing and other quality control techniques are used to the extent TI deems necessary to support this warranty. Except where mandated by applicable law, testing of all parameters of each component is not necessarily performed.

TI assumes no liability for applications assistance or the design of Buyers' products. Buyers are responsible for their products and applications using TI components. To minimize the risks associated with Buyers' products and applications, Buyers should provide adequate design and operating safeguards.

TI does not warrant or represent that any license, either express or implied, is granted under any patent right, copyright, mask work right, or other intellectual property right relating to any combination, machine, or process in which TI components or services are used. Information published by TI regarding third-party products or services does not constitute a license to use such products or services or a warranty or endorsement thereof. Use of such information may require a license from a third party under the patents or other intellectual property of the third party, or a license from TI under the patents or other intellectual property of TI.

Reproduction of significant portions of TI information in TI data books or data sheets is permissible only if reproduction is without alteration and is accompanied by all associated warranties, conditions, limitations, and notices. TI is not responsible or liable for such altered documentation. Information of third parties may be subject to additional restrictions.

Resale of TI components or services with statements different from or beyond the parameters stated by TI for that component or service voids all express and any implied warranties for the associated TI component or service and is an unfair and deceptive business practice. TI is not responsible or liable for any such statements.

Buyer acknowledges and agrees that it is solely responsible for compliance with all legal, regulatory and safety-related requirements concerning its products, and any use of TI components in its applications, notwithstanding any applications-related information or support that may be provided by TI. Buyer represents and agrees that it has all the necessary expertise to create and implement safeguards which anticipate dangerous consequences of failures, monitor failures and their consequences, lessen the likelihood of failures that might cause harm and take appropriate remedial actions. Buyer will fully indemnify TI and its representatives against any damages arising out of the use of any TI components in safety-critical applications.

In some cases, TI components may be promoted specifically to facilitate safety-related applications. With such components, TI's goal is to help enable customers to design and create their own end-product solutions that meet applicable functional safety standards and requirements. Nonetheless, such components are subject to these terms.

No TI components are authorized for use in FDA Class III (or similar life-critical medical equipment) unless authorized officers of the parties have executed a special agreement specifically governing such use.

Only those TI components which TI has specifically designated as military grade or "enhanced plastic" are designed and intended for use in military/aerospace applications or environments. Buyer acknowledges and agrees that any military or aerospace use of TI components which have **not** been so designated is solely at the Buyer's risk, and that Buyer is solely responsible for compliance with all legal and regulatory requirements in connection with such use.

TI has specifically designated certain components which meet ISO/TS16949 requirements, mainly for automotive use. Components which have not been so designated are neither designed nor intended for automotive use; and TI will not be responsible for any failure of such components to meet such requirements.

Products

Audio	www.ti.com/audio
Amplifiers	amplifier.ti.com
Data Converters	dataconverter.ti.com
DLP® Products	www.dlp.com
DSP	dsp.ti.com
Clocks and Timers	www.ti.com/clocks
Interface	interface.ti.com
Logic	logic.ti.com
Power Mgmt	power.ti.com
Microcontrollers	microcontroller.ti.com
RFID	www.ti-rfid.com
OMAP Applications Processors	www.ti.com/omap
Wireless Connectivity	www.ti.com/wirelessconnectivity

Applications

Automotive and Transportation	www.ti.com/automotive
Communications and Telecom	www.ti.com/communications
Computers and Peripherals	www.ti.com/computers
Consumer Electronics	www.ti.com/consumer-apps
Energy and Lighting	www.ti.com/energy
Industrial	www.ti.com/industrial
Medical	www.ti.com/medical
Security	www.ti.com/security
Space, Avionics and Defense	www.ti.com/space-avionics-defense
Video and Imaging	www.ti.com/video

TI E2E Community

e2e.ti.com