

# DS90UH948-Q1EVM User's Guide

## User's Guide



Literature Number: SNLU165  
October 2014

<b>1</b>	<b>DS90UH948-Q1EVM User's Guide</b> .....	<b>5</b>
1.1	General Description .....	5
1.2	Features .....	5
1.3	System Requirements .....	6
1.4	Contents of the Demo Evaluation Kit .....	6
1.5	Applications Diagram .....	6
1.6	Typical Configuration .....	7
1.7	Quick Start Guide .....	8
1.8	Demo Board Connections .....	9
1.9	ALP Software Setup .....	12
1.9.1	System Requirements .....	12
1.9.2	Download Contents .....	12
1.9.3	Installation of the ALP Software .....	12
1.9.4	Installation of the Device Profiles .....	12
1.9.5	Startup - Software Description .....	12
1.9.6	Information Tab .....	14
1.9.7	Pattern Generator Tab .....	15
1.9.8	Registers Tab .....	15
1.9.9	Registers Tab - Address 0x00 selected .....	16
1.9.10	Registers Tab - Address 0x00 expanded .....	17
1.9.11	Scripting Tab .....	19
1.10	Troubleshooting ALP Software .....	20
1.10.1	ALP Loads the Incorrect Profile .....	20
1.10.2	ALP does not detect the EVM .....	22
1.11	CMLOUT Outputs for Eye Monitor .....	24
1.12	Typical Connection and Test Equipment .....	24
1.13	Equipment References .....	25
1.14	Cable References .....	25
<b>2</b>	<b>Bill of Materials</b> .....	<b>26</b>
<b>A</b>	<b>EVM PCB Schematics</b> .....	<b>30</b>
<b>B</b>	<b>Board Layout</b> .....	<b>37</b>

## List of Figures

1-1.	Applications Diagram .....	6
1-2.	Typical Configuration .....	7
1-3.	Interfacing to the EVM .....	8
1-4.	Launching ALP .....	13
1-5.	Initial ALP Screen .....	13
1-6.	Follow-up Screen .....	14
1-7.	ALP Information Tab .....	14
1-8.	ALP Pattern Generator Tab .....	15
1-9.	ALP Registers Tab .....	16
1-10.	ALP Device ID Selected .....	17
1-11.	ALP Device ID Expanded .....	18
1-12.	ALP Scripting Tab .....	19
1-13.	USB2ANY Setup .....	20
1-14.	Remove Incorrect Profile .....	20
1-15.	Add Correct Profile .....	21
1-16.	Finish Setup .....	21
1-17.	ALP No Devices Error .....	22
1-18.	Windows 7, ALP USB Driver .....	22
1-19.	ALP in Demo Mode .....	23
1-20.	ALP Preferences Menu .....	23
1-21.	Typical Test Setup for Video Application .....	24
1-22.	Typical Test Setup for Evaluation .....	24
1	Top Layer .....	37
2	Ground Layer .....	37
3	Power Layer .....	37
4	Bottom Layer .....	37
5	Top Silkscreen .....	38
6	Bottom Silkscreen .....	38

---

## List of Tables

1-1.	Power Supply.....	9
1-2.	OpenLDI Output Signals J15 and J16 .....	9
1-3.	FPD-Link III Input Signals .....	9
1-4.	USB2ANY Connector .....	9
1-5.	I2C/CCI Interface Header J13 .....	10
1-6.	GPIO/Audio Interface Header J17 .....	10
1-7.	SPI/D_GPIO Interface Header J14 .....	10
1-8.	CMLOUT Output Signals.....	10
1-9.	Mode_Sel0 SW-DIP8 - S1 .....	10
1-10.	Mode_Sel1 SW-DIP8 - S2 .....	11
1-11.	IDx SW-DIP8 - S4 .....	11
1-12.	BISTEN/PDN Setting SW-DIP3 - S3 .....	11

## DS90UH948-Q1EVM User's Guide

---

---

### 1.1 General Description

The Texas Instruments DS90Ux948-Q1EVM evaluation module (EVM) converts FPD-Link III to OpenLDI. This kit will demonstrate the functionality and operation of the DS90UH948-Q1/DS90UB948-Q1. The DS90UH948-Q1 supports HDCP content protection but otherwise is the same as DS90UB948-Q1. The information provided in this document can be applied to both devices. The DS90Ux948-Q1 is a FPD-Link III Deserializer which, in conjunction with the DS90Ux949/929/947-Q1 Serializers, it recovers the data from one or two FPD-Link III serial streams and translates it into either single or dual pixel OpenLDI LVDS supporting video resolutions up to WUXGA and 1080p60 with 24-bit color depth.

The FPD-Link III interface supports video and audio data transmission and full duplex control, including GPIOs, I2C, and SPI communication, over the same differential link. In backward compatible mode, the device supports up to WXGA and 720p resolutions with 24-bit color depth over a single differential link.

The device supports up to 7.1 audio channels. Audio data received from the FPD-Link III stream is decrypted and regenerated up to 8-channel I2S interface with maximum bit rate of 192 kHz.

---

**NOTE:** The demo board is not intended for EMI testing. The demo board was designed for easy accessibility to device pins with tap points for monitoring or applying signals, additional pads for termination, and multiple connector options.

---

### 1.2 Features

- Supports Pixel Clock Frequency up to 170 MHz for WUXGA (1920x1200) and 1080p60 resolutions with 24-bit Color Depth
- 2 lane FPD-Link III interface with De-skew capability
- OpenLDI LVDS Transmitter
  - Selectable Single or Dual Pixel LVDS
  - Single Channel: Up to 96 MHz Pixel Clock
  - Dual Channel: Up to 170 MHz Pixel Clock
  - Configurable 18-bit RGB or 24-bit RGB per Pixel
- Capable to recover data up to 15 meters 50Ω Coaxial or Differential Shielded Twisted-Pair (STP) cable
- Backwards Compatible to DS90Ux925Q-Q1/925AQ-Q1 and DS90Ux927Q-Q1 FPD-Link III Serializers
- Adaptive equalization
- @Speed BIST and reporting pin
- Supports 7.1 multiple I2S (4 data) channels
- Single +12V power supply for EVM
- 1.8V or 3.3V compatible LVCMOS I/O interface
- Automotive grade product: AEC-Q100 Grade 2 qualified

### 1.3 System Requirements

In order to demonstrate, the following is required:

1. FPD-Link III compatible Serializer
  - (a) DS90Ux949-Q1, DS90Ux947-Q1 up to 1080p60
  - (b) DS90Ux929-Q1, DS90Ux925Q-Q1/925AQ-Q1, DS90Ux927Q-Q1 up to 720p60
2. Video source
3. Optional I<sup>2</sup>C controller
4. Power supply for 12V @ 1A (required)

### 1.4 Contents of the Demo Evaluation Kit

1. One EVM board with the DS90Ux948-Q1

### 1.5 Applications Diagram

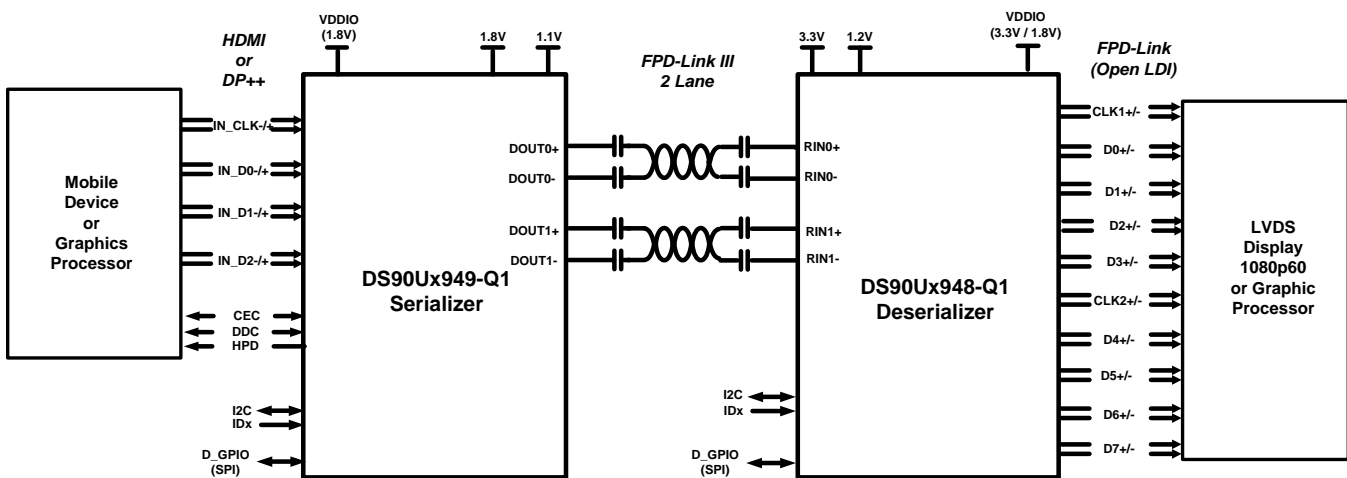


Figure 1-1. Applications Diagram

### 1.6 Typical Configuration

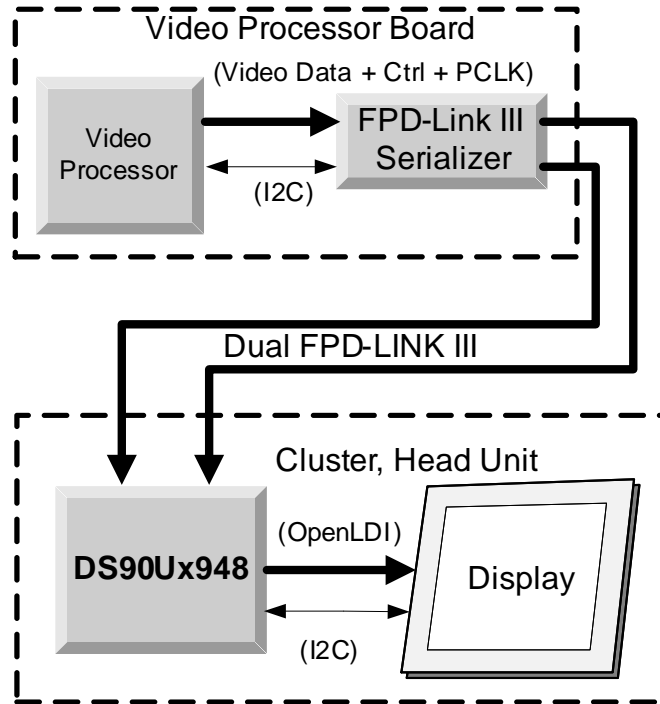


Figure 1-2. Typical Configuration

Figure 1-1 and Figure 1-2 illustrate the use of the chipset in a display application.

### 1.7 Quick Start Guide

1. Connect mini USB J10 to USB port for register programming (optional)
2. Configure switches S1, S2, S3 and S4 to set device's operating modes
3. Connect J1 (RIN0+/- and RIN1+/-) to 1 lane or 2 lane FPD-Link III serial bit stream
4. Connect OpenLDI output signals (J15 and/or J16) to panel
5. Provide power to board on J18 (12V)
  - (a) Optional +1.2VDC power supply on JP8, +1.8VDC power supply on JP9 and +3.3VDC power supply on JP10
6. For details of pin-names and pin-functions, please refer to the DS90Ux948-Q1 datasheet.

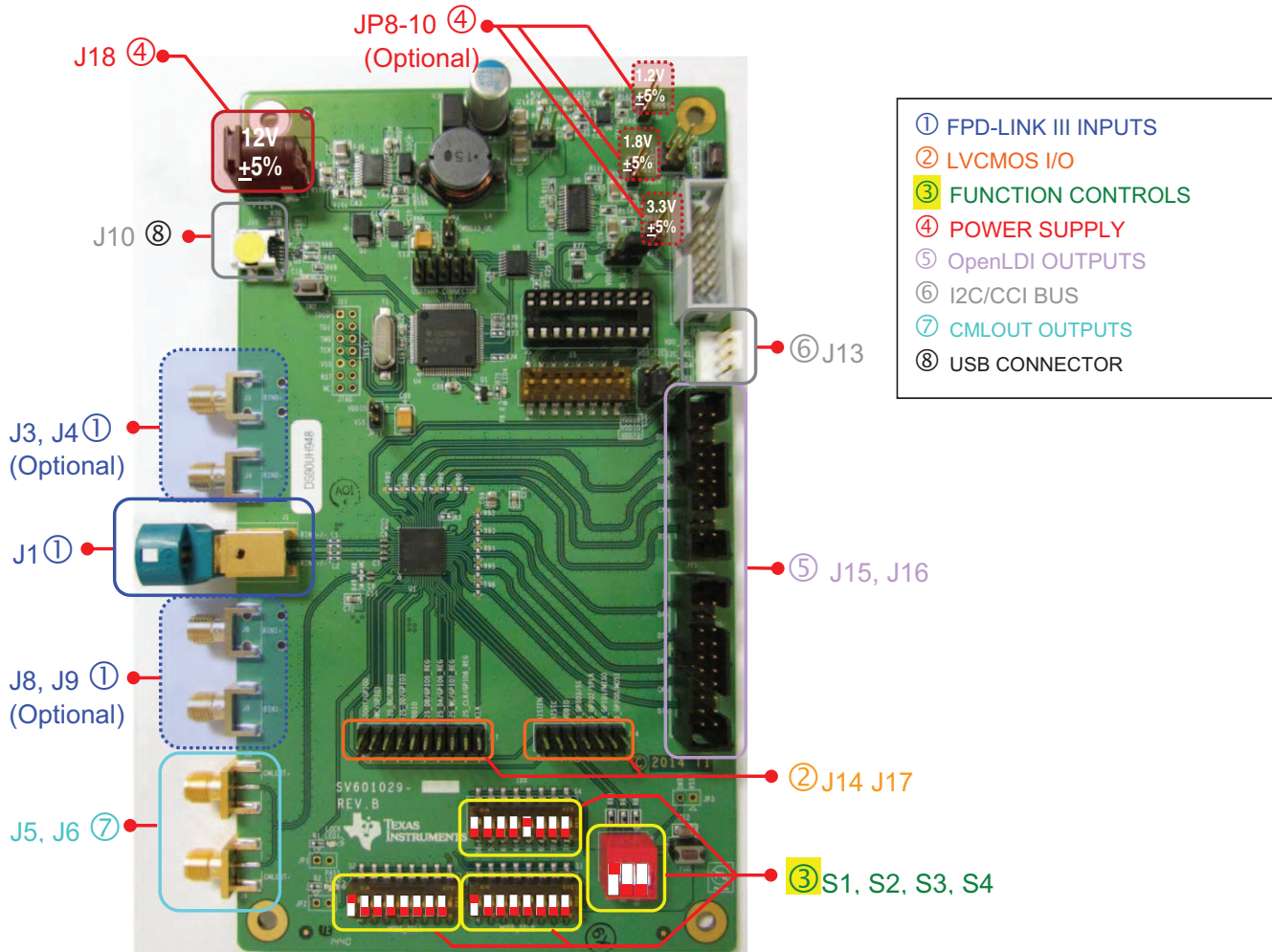


Figure 1-3. Interfacing to the EVM



## 1.8 Demo Board Connections

**Table 1-1. Power Supply**

Reference	Signal	Description
J18	+12V	12V $\pm$ 5% Main Power Single +12V power connector that supplies power to the entire board.
JP8 (Optional)	+1.2V	1.2V $\pm$ 5% Alternative to Main Power
JP9 (Optional)	+1.8V	1.8V $\pm$ 5% Alternative to Main Power
JP10 (Optional)	+3.3V	3.3V $\pm$ 5% Alternative to Main Power

**Table 1-2. OpenLDI Output Signals J15 and J16**

Reference	Port	Signal
J15.2	OpenLDI Port 0	D0-
J15.3		D0+
J15.6		D1-
J15.7		D1+
J15.10		D2-
J15.11		D2+
J15.14		CLK1-
J15.15		CLK1+
J15.18		D3-
J15.19		D3+
J16.2	OpenLDI Port 1	D4-
J16.3		D4+
J16.6		D5-
J16.7		D5+
J16.10		D6-
J16.11		D6+
J16.14		CLK2-
J16.15		CLK2+
J16.18		D7-
J16.19		D7+

**Table 1-3. FPD-Link III Input Signals**

Reference	Signal	Description
J1	RIN0+/- RIN1+/-	HSD connector
J3 (Optional)	RIN0+	SMA connector
J4 (Optional)	RIN0-	SMA connector
J8 (Optional)	RIN1+	SMA connector
J9 (Optional)	RIN1-	SMA connector

**Table 1-4. USB2ANY Connector**

Reference	Description
J10	mini USB 5 pin

**Table 1-5. I2C/CCI Interface Header J13**

Reference	Signal
J13.1	VDDI2C
J13.2	SCL
J13.3	SDA
J13.4	GND

**Table 1-6. GPIO/Audio Interface Header J17**

Reference	Signal	Description
J17.2	SDOUT/GPIO0	Aux I2S Data Output / Remote or Local I/O
J17.4	SWC/GPIO1	Aux I2S Word Clock Output / Remote or Local I/O
J17.6	I2S_DC/GPIO2	I2S Data Output / Remote or Local I/O
J17.8	I2S_DD/GPIO3	I2S Data Output / Remote or Local I/O
J17.10	VDDIO	GPIO Voltage Level 1.8V or 3.3V
J17.12	I2S_DB/GPIO5	I2S Data Output / Local only I/O
J17.14	I2S_DA/GPIO6	I2S Data Output / Local only I/O
J17.16	I2S_WC/GPIO7	I2S Word Clock Output/ Local only I/O
J17.18	I2S_CLK_GPIO8	I2S Clock Output / Local only I/O
J17.20	MCLK	I2S System Clock Output

**Table 1-7. SPI/D\_GPIO Interface Header J14**

Reference	Signal	Description
J14.2	BISTEN	BIST Enable Pin (Shared with S3)
J14.4	BISTC	BIST Clock Select (Shared with S3)
J14.6	VDDIO	GPIO Voltage Level 1.8V or 3.3V
J14.8	D_GPIO3/SS	I/O in 2 lane FPD-Link III mode / Slave Select
J14.10	D_GPIO2/SCLK	I/O in 2 lane FPD-Link III mode / Serial Clock
J14.12	D_GPIO1/MISO	I/O in 2 lane FPD-Link III mode / Master In, Slave Out
J14.14	D_GPIO0/MOSI	I/O in 2 lane FPD-Link III mode / Master Out, Slave In

**Table 1-8. CMLOUT Output Signals**

Reference	Signal	Description
J5	CMLOUT+	SMA connector
J6	CMLOUT-	SMA connector

**Table 1-9. Mode\_Sel0 SW-DIP8 - S1<sup>(1)</sup>**

Reference	Map Select	Output Mode
S1.1	0	Dual OLDI output
S1.2	0	Dual SWAP output
S1.3	0	Single OLDI output
S1.4	0	Replicate
S1.5 (Default)	1	Dual OLDI output
S1.6	1	Dual SWAP output
S1.7	1	Single OLDI output
S1.8	1	Replicate

<sup>(1)</sup> Only set one ON.

**Table 1-10. Mode\_Sel1 SW-DIP8 - S2<sup>(1)</sup>**

Reference	Repeater	Mode	High Speed Back Channel	Input Mode
S1.1 (Default)	0	00	5 Mbps	STP
S1.2	0	01	5 Mbps	Coax
S1.3	0	10	20 Mbps	STP
S1.4	0	11	20 Mbps	Coax
S1.5	1	00	5 Mbps	STP
S1.6	1	01	5 Mbps	Coax
S1.7	1	10	20 Mbps	STP
S1.8	1	11	20 Mbps	Coax

<sup>(1)</sup> Only set one ON.

**Table 1-11. IDx SW-DIP8 - S4<sup>(1)</sup>**

Reference	7-bit Address	8-bit Address
S1.1 (Default)	0x2C	0x58
S1.2	0x2E	0x5C
S1.3	0x30	0x60
S1.4	0x32	0x64
S1.5	0x34	0x68
S1.6	0x36	0x6C
S1.7	0x38	0x70
S1.8	0x3C	0x78

<sup>(1)</sup> Only set one ON.

**Table 1-12. BISTEN/PDN Setting SW-DIP3 - S3**

Reference	Signal	Input = L	Input = H	Description
S3.1	BISTEN <sup>(1)</sup>	Normal operating mode. BIST is disabled. (Default)	BIST Mode is enabled.	BIST Enable Input
S3.2	BISTC	External Pixel Clock (Default)	Internal Pixel Clock (~50MHz)	BIST Clock Select
S3.3	PDB	Power Down (Disabled)	Operational (Default)	Power Down Mode Input

<sup>(1)</sup> Before BIST can be enabled, the 948 D\_GPIO[0] has to be strapped high and D\_GPIO[3:1] strapped low on J14.

## 1.9 ALP Software Setup

### 1.9.1 System Requirements

<b>Operating System:</b>	Windows 7 64-bit
<b>USB:</b>	USB2ANY
<b>USB2ANY Firmware Version:</b>	2.5.2.0

### 1.9.2 Download Contents

TI Analog LaunchPAD can be downloaded from: <http://www.ti.com/tool/alp>.

Download and extract the “snlc048.zip” file to a temporary location that can be deleted later.

---

**NOTE:** Make sure J10 on the DS90Ux948-Q1EVM is connected to a PC USB port with USB cable and power is applied to the board.

---

The following installation instructions are for the Windows 7 64-bit Operating System.

### 1.9.3 Installation of the ALP Software

Execute the ALP Setup Wizard program called “ALPF\_setup\_v\_x\_x\_x.exe” that was extracted to a temporary location on the local drive of your PC.

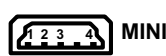
There are 7 steps to the installation once the setup wizard is started:

1. Select the “Next” button.
2. Select “I accept the agreement” and then select the “Next” button.
3. Select the location to install the ALP software and then select the “Next” button.
4. Select the location for the start menu shortcut and then select the “Next” button.
5. There will then be a screen that allows the creation of a desktop icon. After selecting the desired choices select the “Next” button.
6. Select the “Install” button, and the software will then be installed to the selected location.
7. Uncheck “Launch Analog LaunchPAD” and select the “Finish” button. The ALP software will start if “Launch Analog LaunchPAD” is checked, but it will not be useful until the USB driver is installed and board is attached.

Connect J10 USB jack of the DS90Ux948-Q1 EVM board to a PC/laptop USB port using a Type A



**A**



MINI

to mini-B USB cable. Power the DS90Ux948-Q1 EVM board with a 12 VDC power supply. The “Found New Hardware Wizard” will open on the PC/laptop.

### 1.9.4 Installation of the Device Profiles

There are 2 steps to add the DS90Ux948 profile:

1. Contact TI for the DS90Ux948 profile
2. Extract the “DS90Ux948.zip” to ALP’s profile folder. The profile folder can be found at: C:\Program Files (x64)\Texas Instruments\Analog LaunchPAD vx.x.x\Profiles\

### 1.9.5 Startup - Software Description

Make sure all the software has been installed and the hardware is powered on and connected to the PC. Execute “Analog LaunchPAD” shortcut from the start menu. The default start menu location is under All Programs > Texas Instruments > Analog LaunchPAD vx.x.x > Analog LaunchPAD to start MainGUI.exe.



Figure 1-4. Launching ALP

The application should come up in the state shown in the figure below. If it does not, see [Section 1.10](#), “Troubleshooting ALP Software”.

Under the Devices tab click on “DS90Ux948\_ENG” to select the device and open up the device profile and its associated tabs.

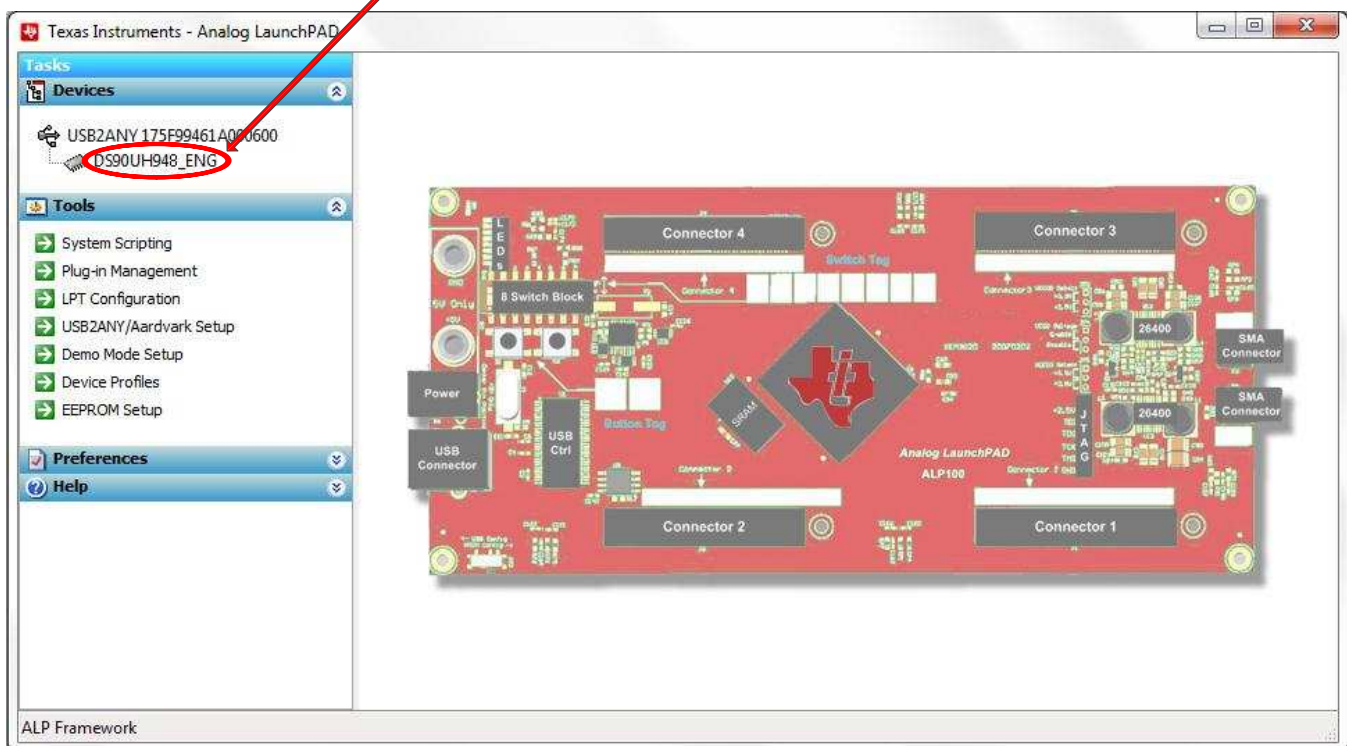


Figure 1-5. Initial ALP Screen

After selecting the DS90Ux948, the following screen should appear.

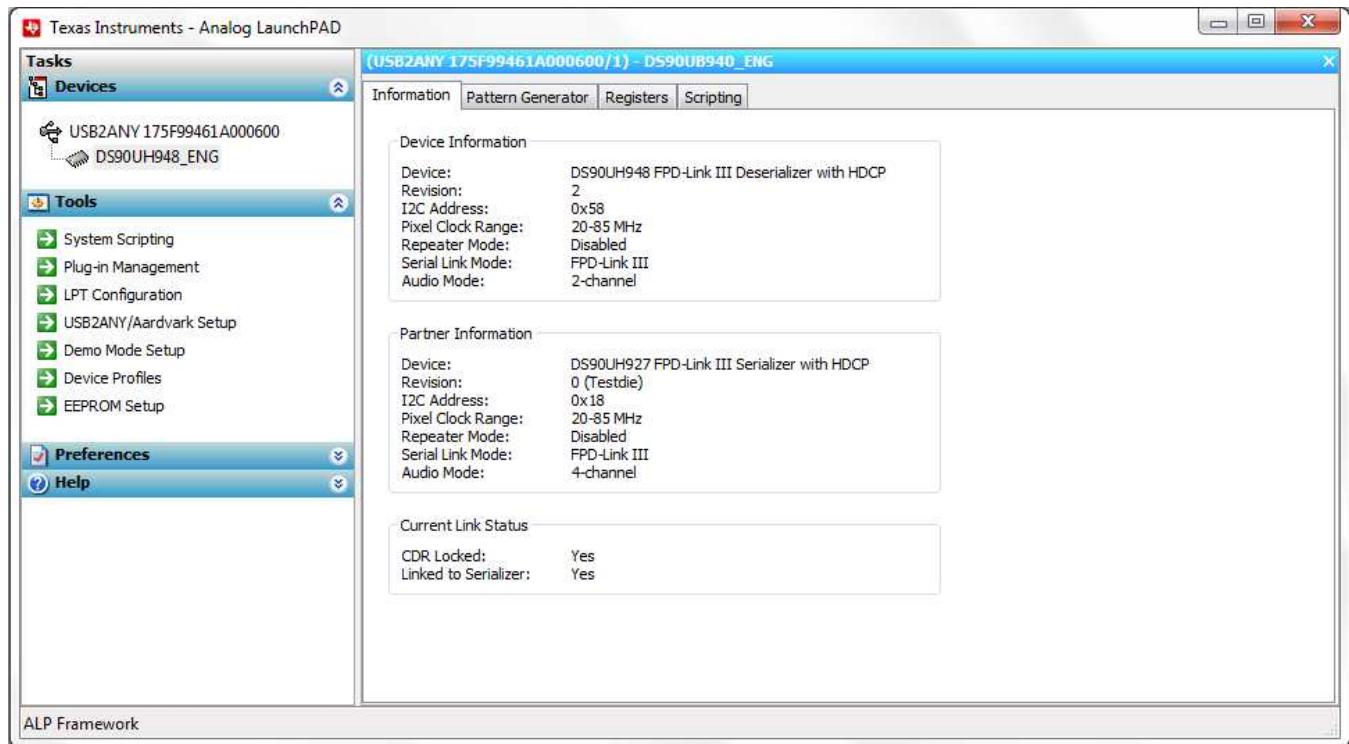


Figure 1-6. Follow-up Screen

### 1.9.6 Information Tab

The Information tab is shown below. Please note the device revision could be different.

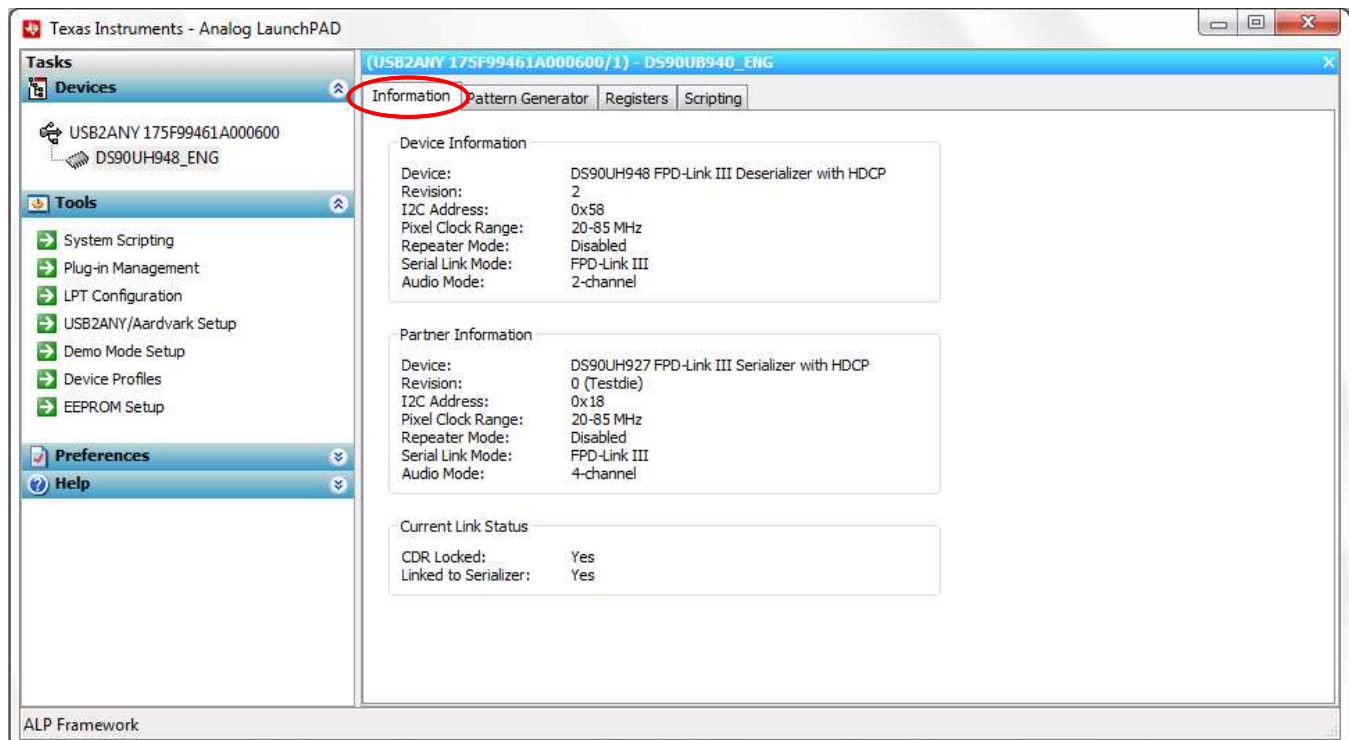


Figure 1-7. ALP Information Tab



### 1.9.7 Pattern Generator Tab

The DES Pattern Generator tab is shown below.

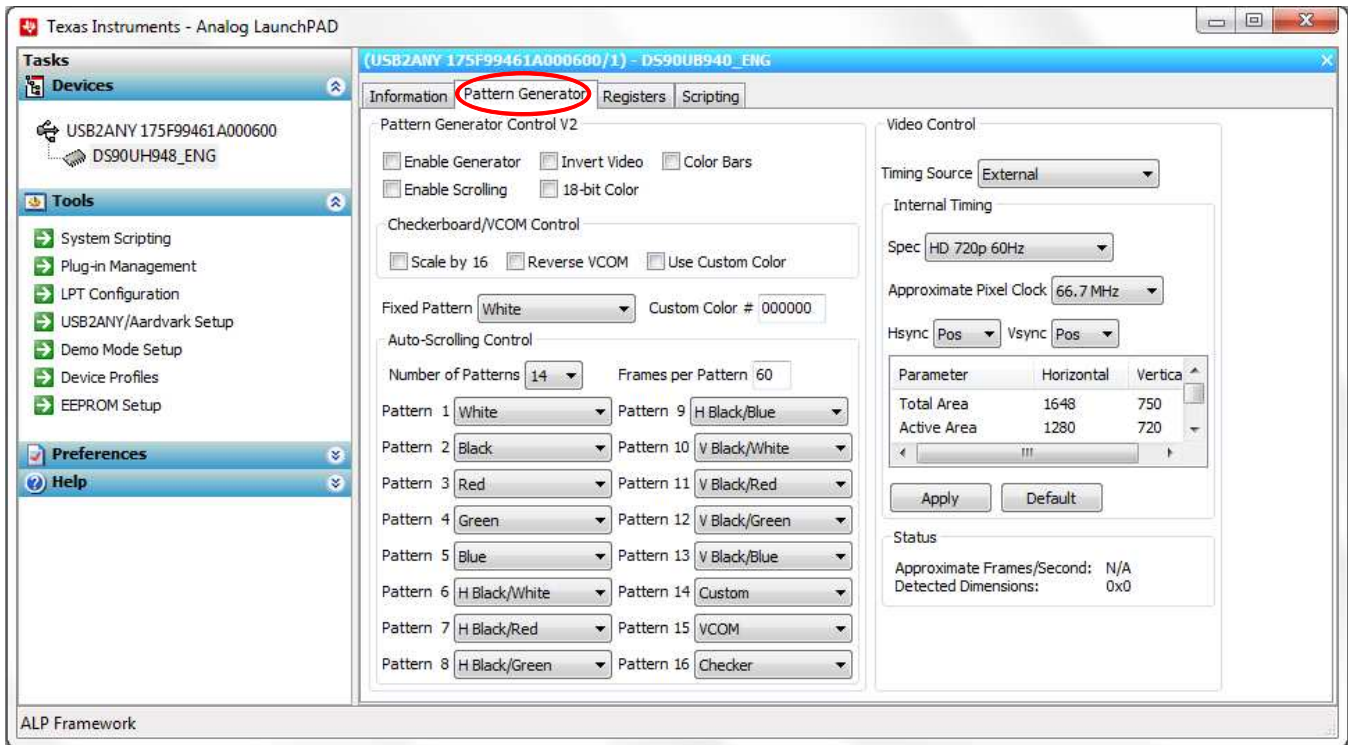
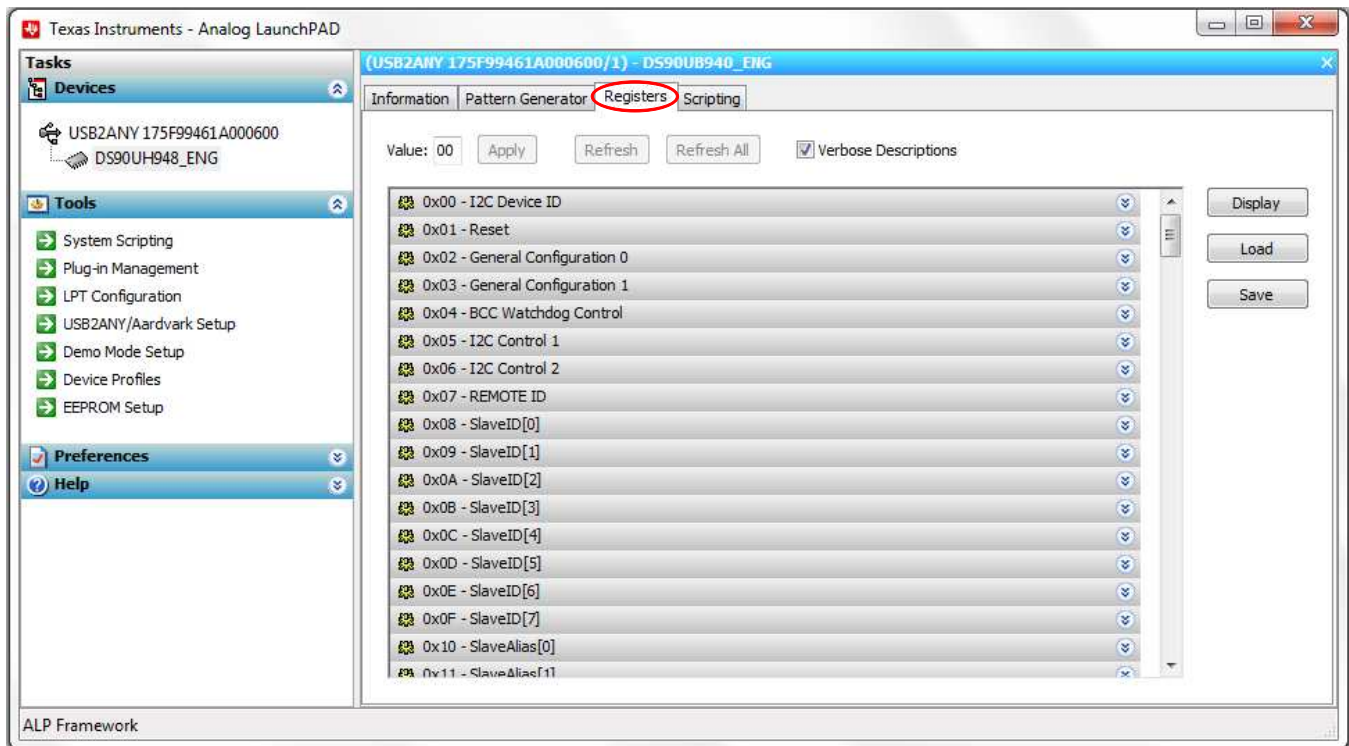


Figure 1-8. ALP Pattern Generator Tab

### 1.9.8 Registers Tab

The Register tab is shown below.



**Figure 1-9. ALP Registers Tab**

### 1.9.9 Registers Tab - Address 0x00 selected

Address 0x00 selected as shown below. Note that the “Value:” box, Value:  , will now show the hex value of that register.



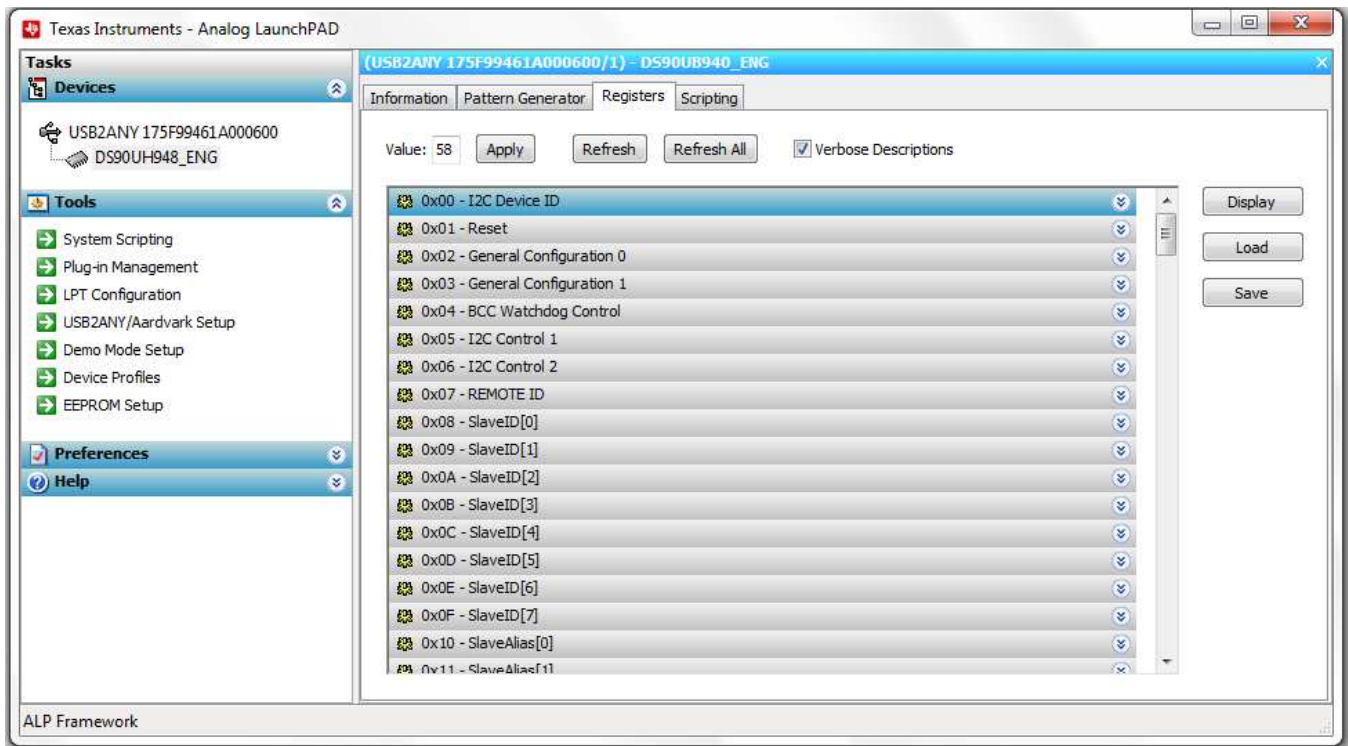



Figure 1-10. ALP Device ID Selected

### 1.9.10 Registers Tab - Address 0x00 expanded

By double clicking on the Address bar



or a single click on . Address 0x00 expanded reveals contents by bits. Any register address displayed can be expanded.

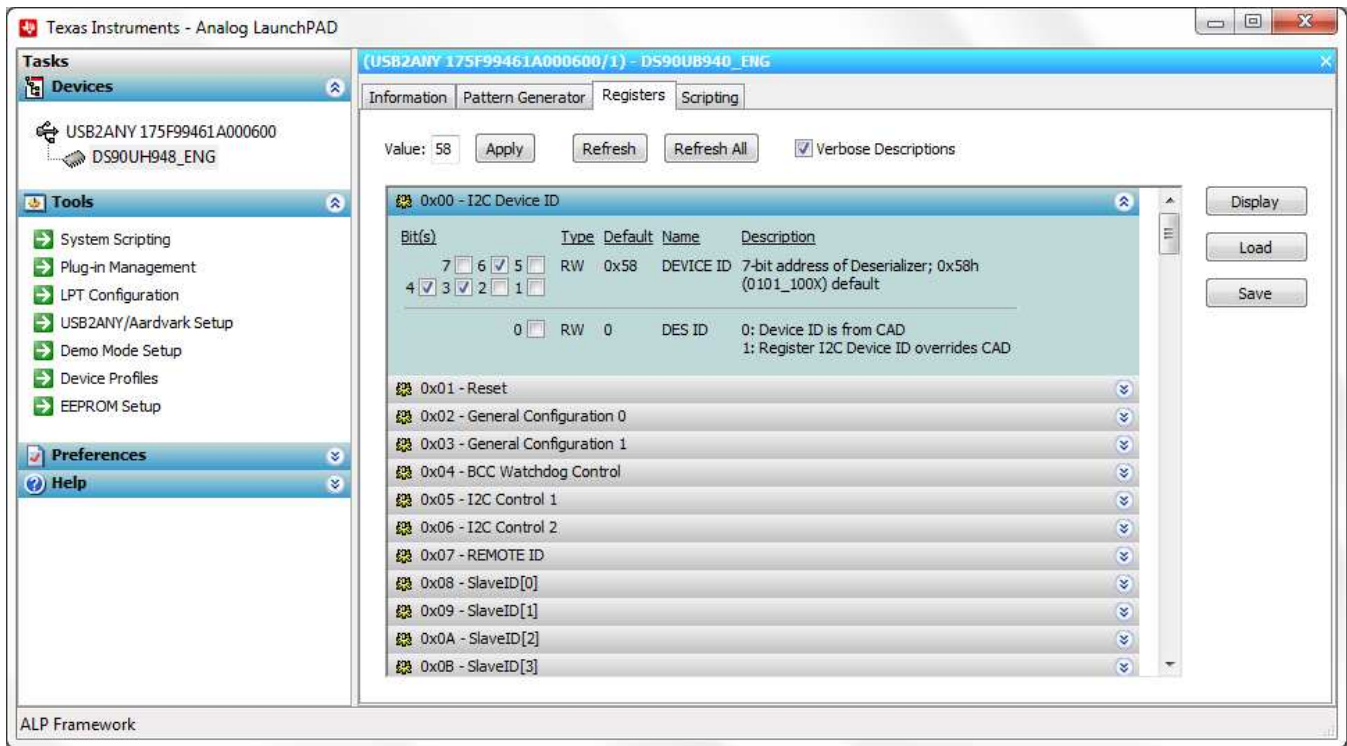
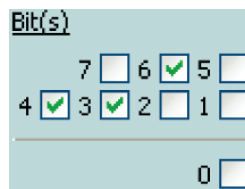


Figure 1-11. ALP Device ID Expanded

**Type**

Any RW Type register, **RW**, can be written into by writing the hex value into the “Value:” box, **Value: 00** or putting the pointer into the individual register bit(s) box by a left mouse click to put a check mark (indicating a “1”) or unchecking to remove the check mark (indicating a “0”). Click the “Apply” button to write to the register, and “refresh” to see the new value of the selected (highlighted) register.



The box toggles on every mouse click.

### 1.9.11 Scripting Tab

The Scripting tab is shown below.

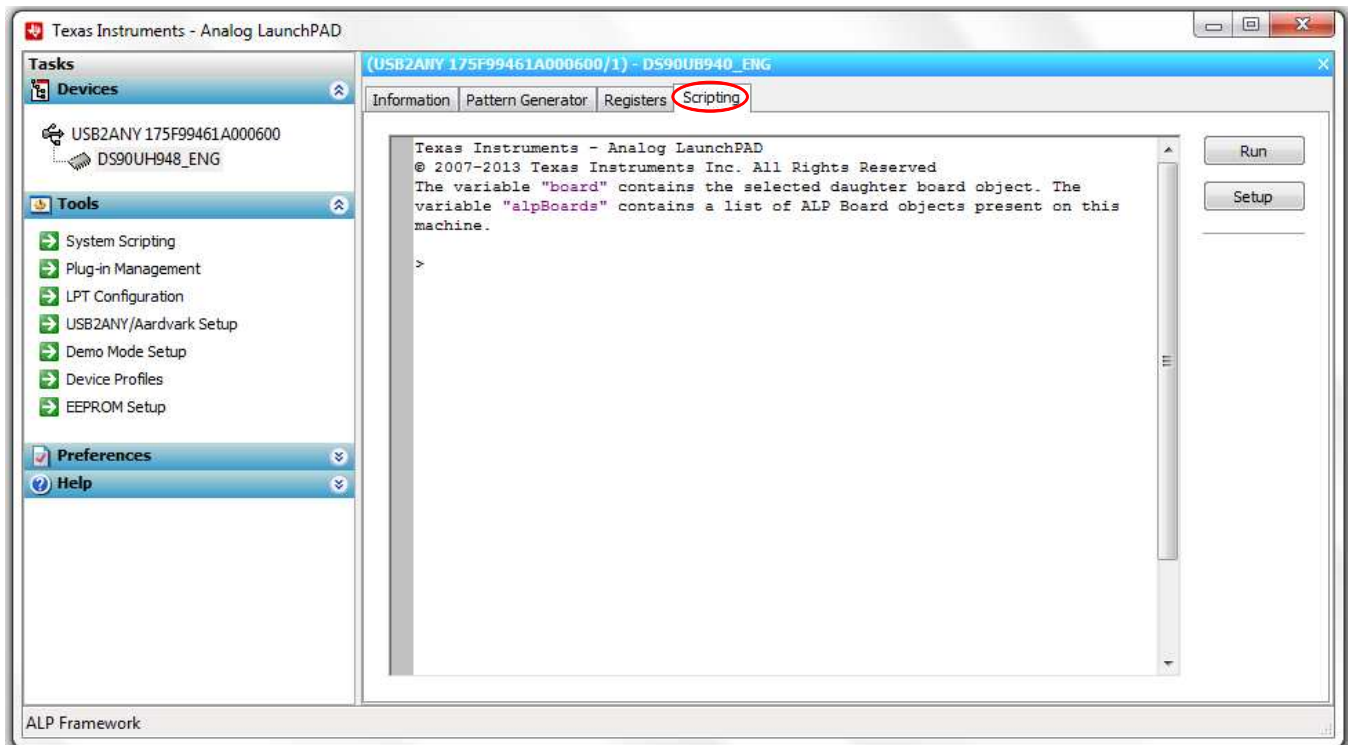


Figure 1-12. ALP Scripting Tab

The script window provides a full Python scripting environment which can be for running scripts and interacting with the device in an interactive or automated fashion.

#### **WARNING**

**Directly interacting with devices either through register modifications or calling device support library functions can effect the performance and/or functionality of the user interface and may even crash the ALP Framework application.**

## 1.10 Troubleshooting ALP Software

### 1.10.1 ALP Loads the Incorrect Profile

If ALP opens with the incorrect profile loaded the correct profile can be loaded from the USB2ANY/Aardvark Setup found under the tools menu.

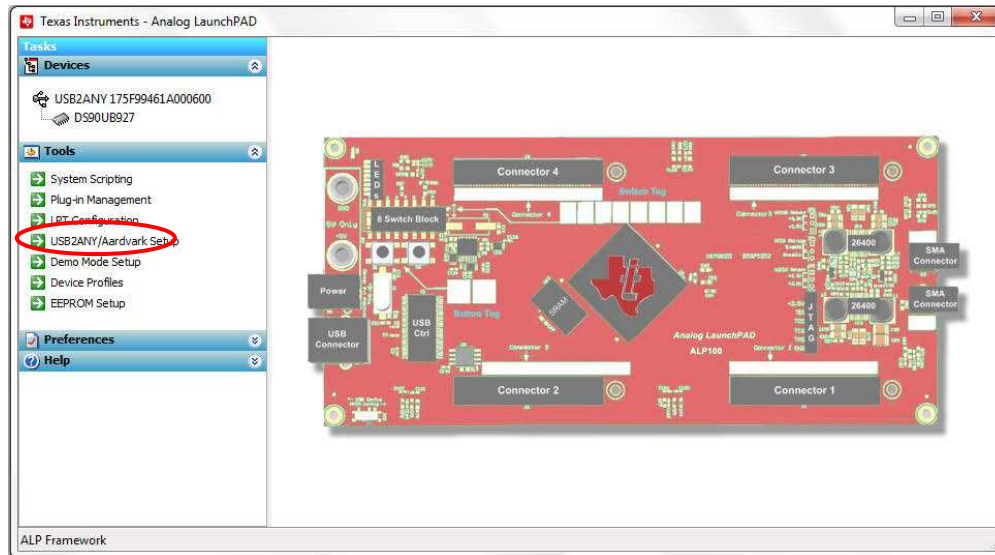


Figure 1-13. USB2ANY Setup

Highlight the incorrect profile in the Defined ALP Devices list and press the remove button.

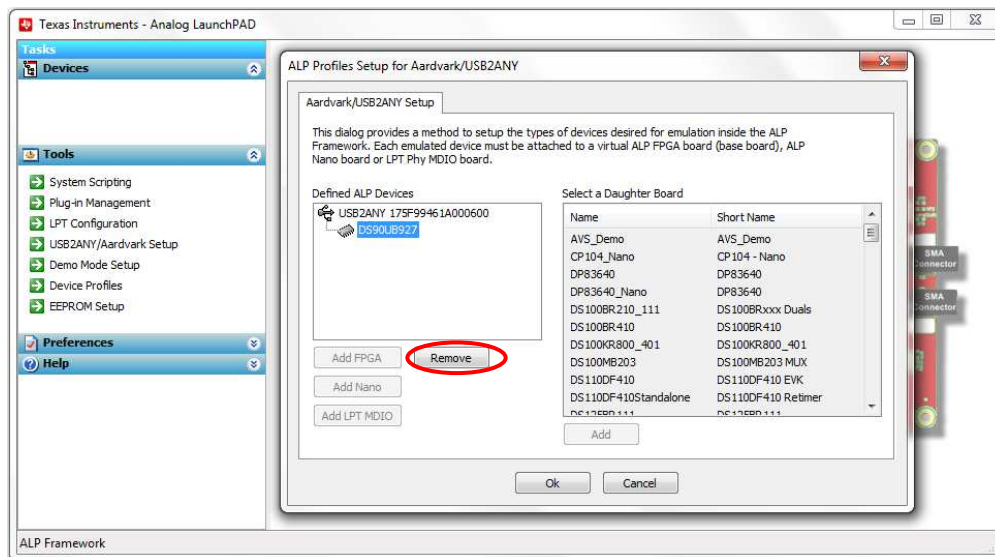


Figure 1-14. Remove Incorrect Profile

Find the correct profile under the Select a Daughter Board list, highlight the profile and press Add.

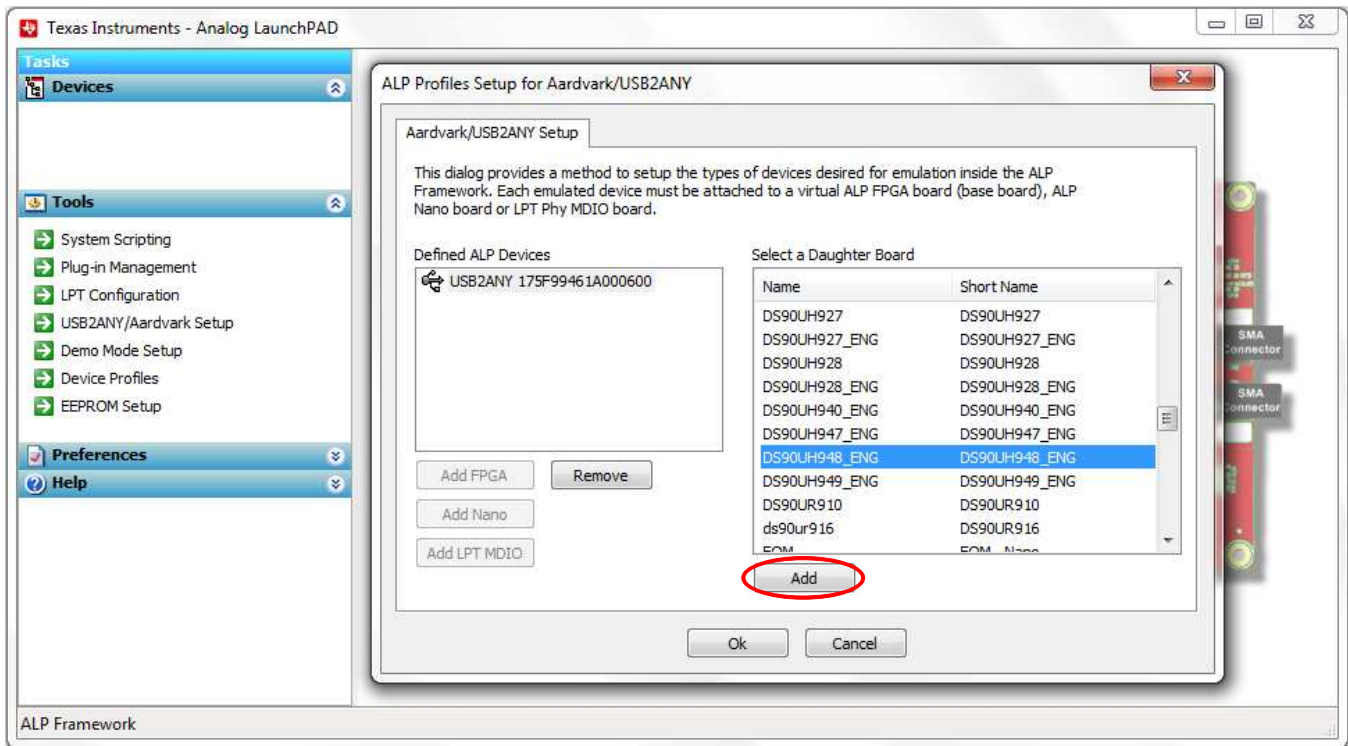


Figure 1-15. Add Correct Profile

Select Ok and the correct profile should now be loaded.

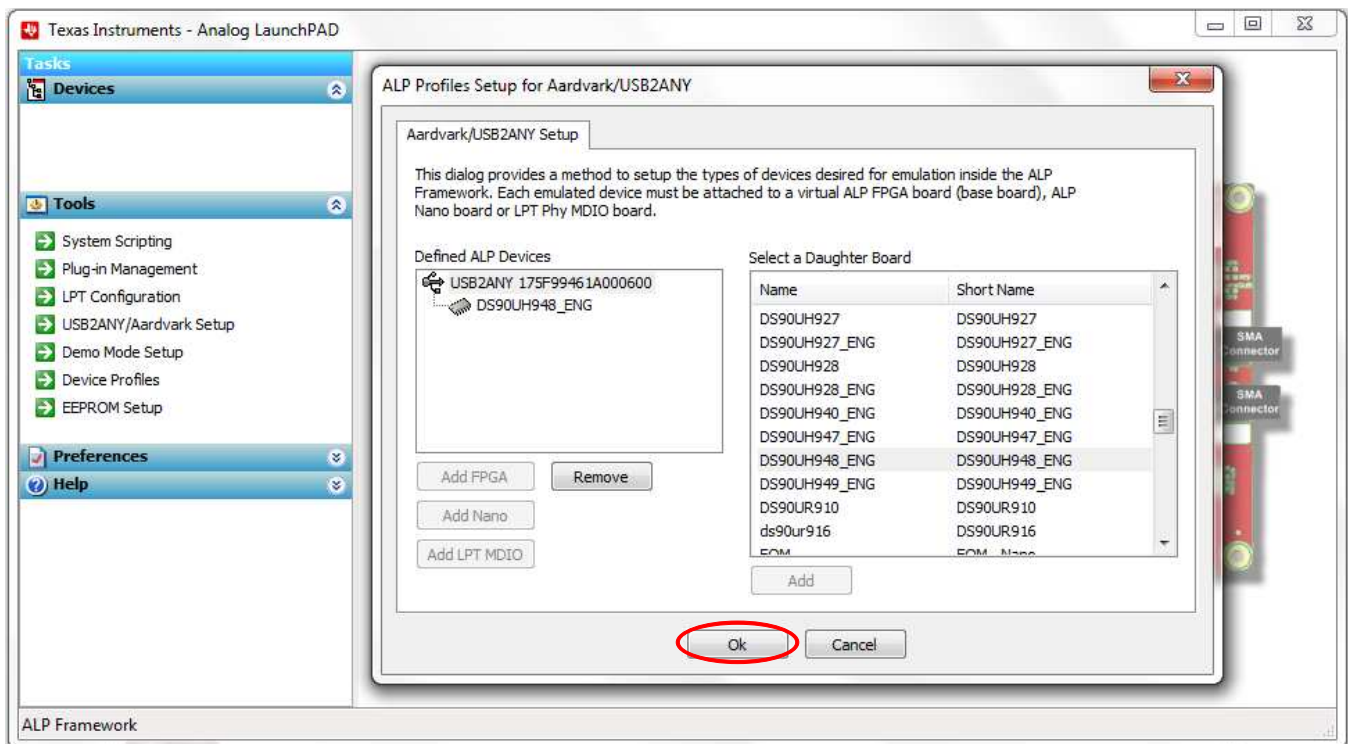
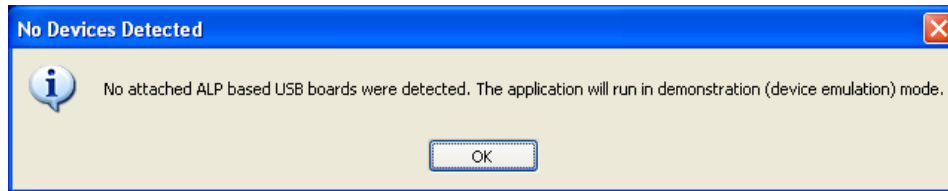


Figure 1-16. Finish Setup

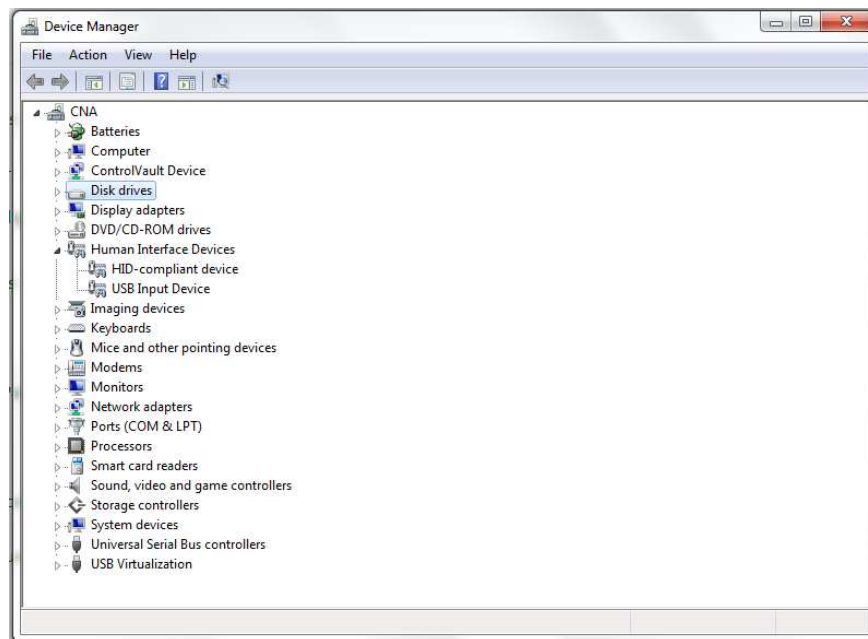
### 1.10.2 ALP does not detect the EVM

If the following window opens after starting the ALP software, double check the hardware setup.



**Figure 1-17. ALP No Devices Error**

It may also be that the USB driver is not installed. Check the device manager. There should be a “HID-compliant device” under the “Human Interface Devices” as shown below.



**Figure 1-18. Windows 7, ALP USB Driver**

The software should start with only “DS90UH948\_ENG” in the “Devices” pull down menu. If there are more devices then the software is most likely in demo mode. When the ALP is operating in demo mode there is a “(Demo Mode)” indication in the lower left of the application status bar as shown below.



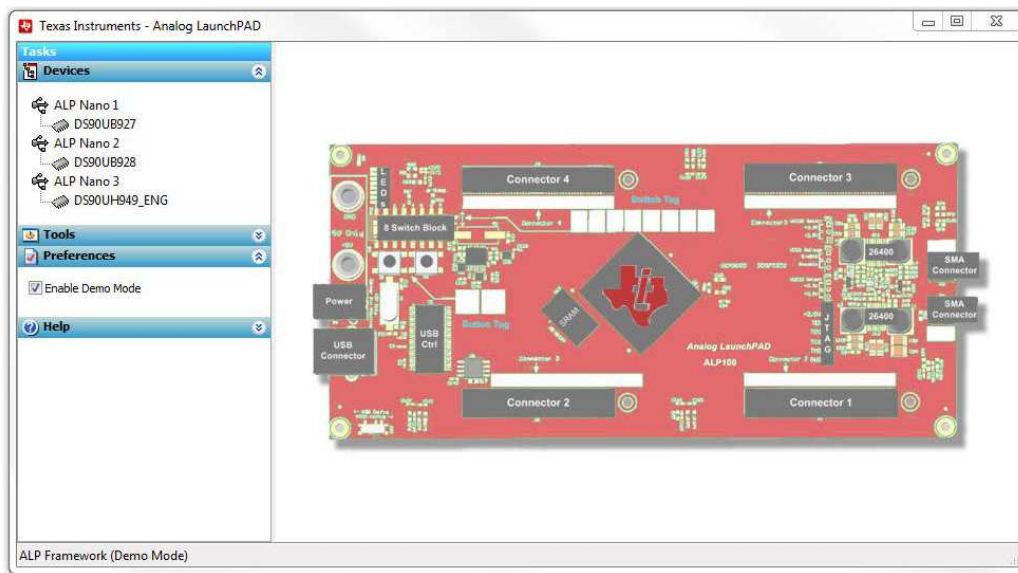


Figure 1-19. ALP in Demo Mode

Disable the demo mode by selecting the “Preferences” pull down menu and un-checking “Enable Demo Mode”.

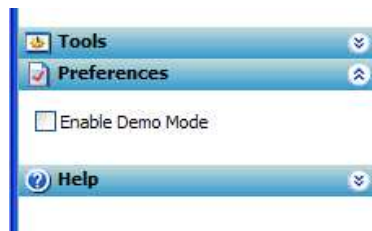


Figure 1-20. ALP Preferences Menu

After demo mode is disabled, the ALP software will poll the ALP hardware. The ALP software will update and have only “DS90UH948\_ENG” under the “Devices” pull down menu.

## 1.11 CMLOUT Outputs for Eye Monitor

Connector J5 connects to CMLOUT+ and J6 connects to CMLOUT-, which are present on the bottom right side of DS90Ux948Q Evaluation board. CMLOUT+/- must be enabled by register,  $0x56[3] = 1$  with  $0x57$  and  $0x52$ , to be able to monitor the recovered FPD-Link III serial stream (see datasheet for details).

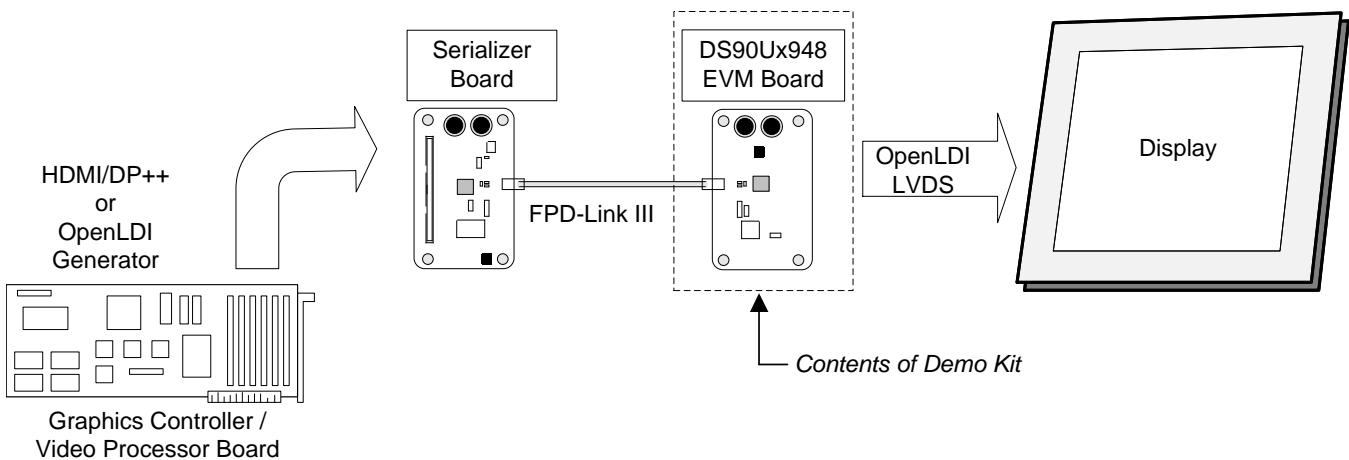
- Reg  $0x57[2:1]$  : 10 for channel 1, 01 for channel 0
- Reg  $0x52[7]$  : 1 for channel 1 ; 0 for channel 0

## 1.12 Typical Connection and Test Equipment

The following is a list of typical test equipment that may be used to generate signals for the Serializer inputs:

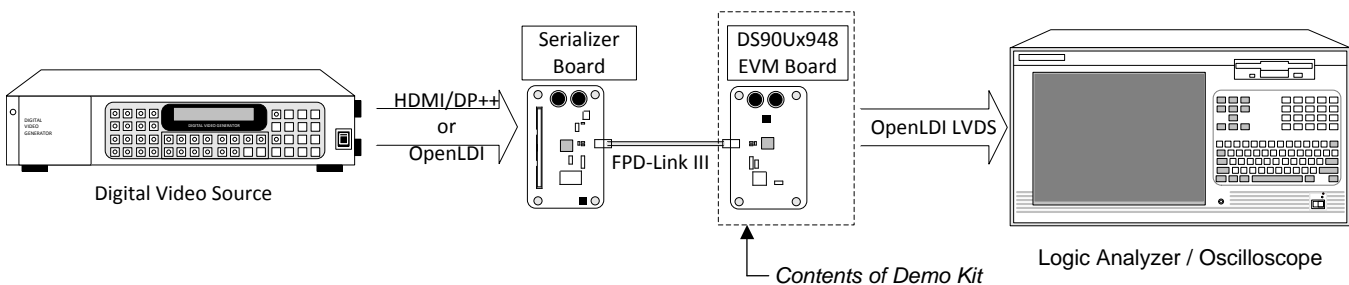
1. Digital Video Source – for generation of specific display timing such as Digital Video Processor or Graphics Controller (GPU) with HDMI or OpenLDI output.
2. Any other signal generator / video source - This video generator may be used for video signal sources for DVI or DP++
3. Any other signal / video generator that provides the correct input levels as specified in the datasheet.

The picture below shows a typical test set up using a Graphics Controller and display.



**Figure 1-21. Typical Test Setup for Video Application**

The picture below shows a typical test set up using a video generator and logic analyzer.



**Figure 1-22. Typical Test Setup for Evaluation**



## 1.13 Equipment References

---

**NOTE:** Please note that the following references are supplied only as a courtesy to our valued customers. It is not intended to be an endorsement of any particular equipment or supplier.

---

### **Digital Video Pattern Generator:**

Astrodesign

[www.astro-americas.com](http://www.astro-americas.com)

### **Logic Analyzer:**

Agilent Technologies Inc

[www.agilent.com](http://www.agilent.com)

### **Corelis CAS-1000-I2C/E I2C Bus Analyzer and Exerciser Products:**

[www.corelis.com/products/I2C-Analyzer.htm](http://www.corelis.com/products/I2C-Analyzer.htm)

### **Aardvark I2C/SPI Host Adapter Part Number: TP240141**

[www.totalphase.com/products/aardvark\\_i2cspi](http://www.totalphase.com/products/aardvark_i2cspi)

## 1.14 Cable References

For optimal performance, we recommend Shielded Twisted Pair (STP) 100ohm differential impedance and 24 AWG (or larger diameter) cable for high-speed data applications.

### **Leoni Dacar 535 series cable:**

[www.leoni-automotive-cables.com](http://www.leoni-automotive-cables.com)

### **Rosenberger HSD connector:**

[www.rosenberger.de/en/Products/35\\_Automotive\\_HSD.php](http://www.rosenberger.de/en/Products/35_Automotive_HSD.php)

## Bill of Materials

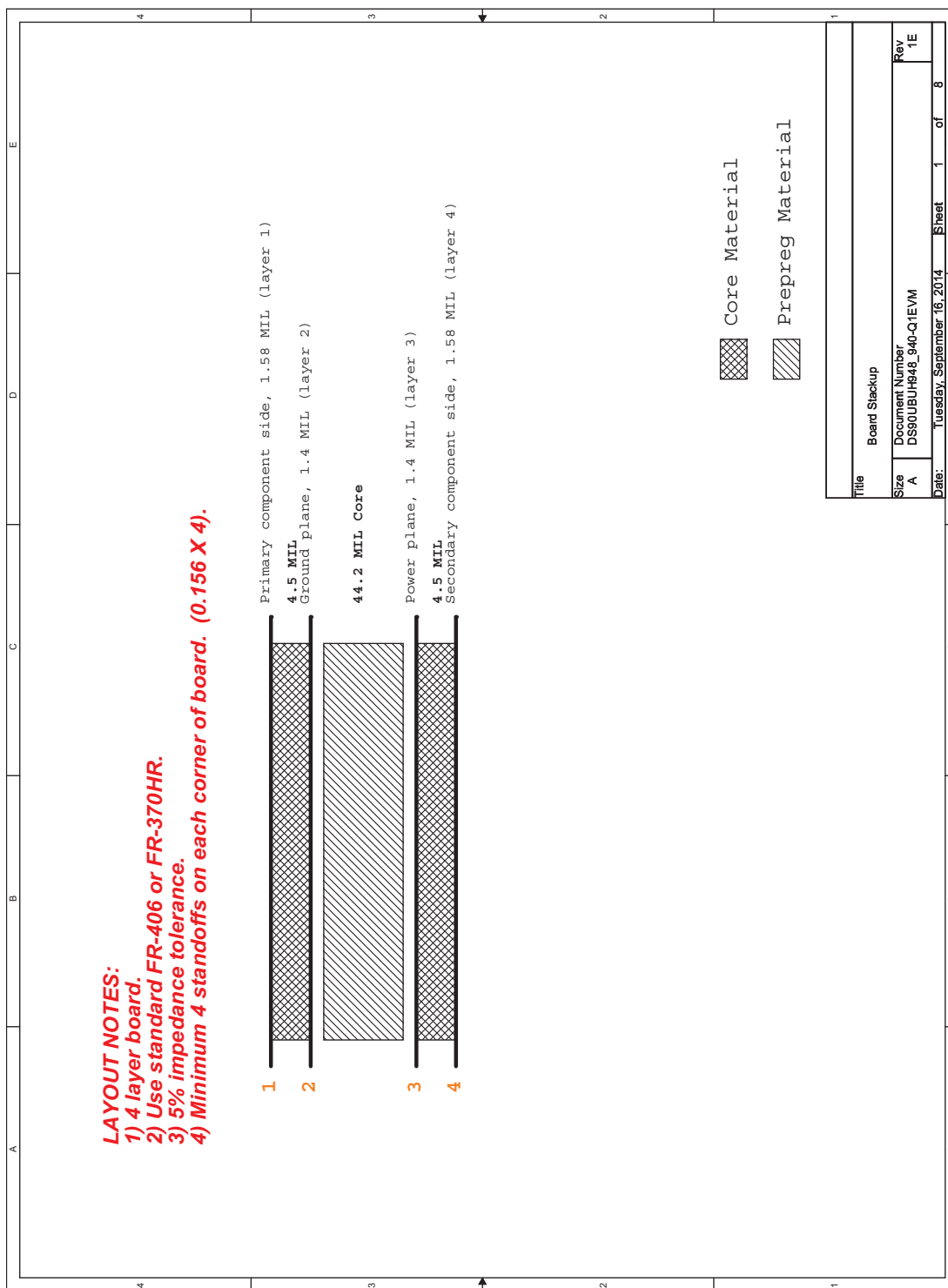
Item	Qty	References	Value	Part Number	Mfr	Description
1	35	C1, C2, C5, C8, C9, C10, C11, C17, C23, C24, C25, C26, C27, C30, C31, C32, C35, C48, C50, C53, C56, C61, C65, C69, C73, C77, C79, C83, C90, C93, C99, C100, C102, C103, C104	0.1uF	CGA2B3X7R1H104K050BB	TDK Corporation	CAP CER 0.1UF 50V 10% X7R 0402
2	4	C3, C4, C6, C7	0.033uF	CGA2B3X7R1H333K050BB	TDK Corporation	CAP CER 0.033UF 50V 10% X7R 0402
3	3	C12, C66, C80	10uF	C3216X7R1C106K	TDK	CAP CER 10UF 16V X7R 10% 1206
4	2	C13, C89	2.2uF	T491B225K020AT	KEMET	CAP TANT 2.2UF 20V 10% 1411
5	10	C14, C47, C55, C60, C64, C68, C72, C76, C82, C92	1uF	CGA3E1X7R1E105K080AC	TDK Corporation	CAP CER 1UF 25V 10% X7R 0603
6	15	C15, C44, C51, C57, C58, C62, C70, C74, C78, C84, C85, C86, C87, C94, C95	0.01uF	GCM155R71H103KA55D	Murata Electronics	CAP CER 10000PF 50V 10% X7R 0402
7	2	C16, C88	22uF	F931E226MNC	nichicon	CAP TANT 22UF 25V 20% 2917
8	2	C18, C21	220PF	C1608X7R1H221K	TDK	CAP CER 220PF 50V 10% X7R 0603
9	2	C19, C20	30pF	C1608C0G1H300J	TDK	CAP CER 30PF 50V 5% NP0 0603
10	1	C22	2200PF	C1608X7R1H222K	TDK	CAP CER 2200PF 50V 10% X7R 0603
11	5	C28, C46, C49, C52, C63	4.7uF	GRM21BR71C475KA73L	Murata Electronics	CAP CER 4.7UF 16V 10% X7R 0805
12	1	C29	470nF	C1608X7R1H474K080AC	TDK	CAP CER 0.47UF 50V 10% X7R 0603
13	2	C33, C34	4.7pF	ECD-G0E4R7C	Panasonic	CAP CER 4.7PF 25V NP0 0402
14	1	C36	0.022uF	C0805C223K5RACTU	Kemet	CAP CER 0.022UF 50V 10% X7R 0805
15	1	C37	10uF	C3225X7R1E106M250AC	TDK Corporation	CAP CER 10UF 25V X7R 20% 1210
16	1	C38	100uF	EEF-UD0K101R	Panasonic	CAP ALUM 100UF 8V 20% SMD
17	1	C39	270uF	APXA100ARA271MHC0G	United Chemi-Con	CAP ALUM 270UF 10V 20% SMD
18	2	C40, C41	100uF	JMK325BJ107MM-T	Taiyo Yuden	CAP CER 100UF 6.3V 20% X5R 1210
19	1	C42	180pF	CC0805JRNPO9BN181	Yageo	CAP CER 180PF 50V 5% NPO 0805
20	1	C43	150pF	08055A151JAT2A	AVX Corporation	CAP CER 150PF 50V 5% NP0 0805
21	1	C45	560pF	CC0805KRX7R9BB561	Yageo	CAP 560PF 50V CERAMIC X7R 0805
22	7	C54, C59, C67, C71, C75, C81, C91	10uF	JMK212AB7106KGHT	Taiyo Yuden	CAP CER 10UF 6.3V 10% X7R 0805

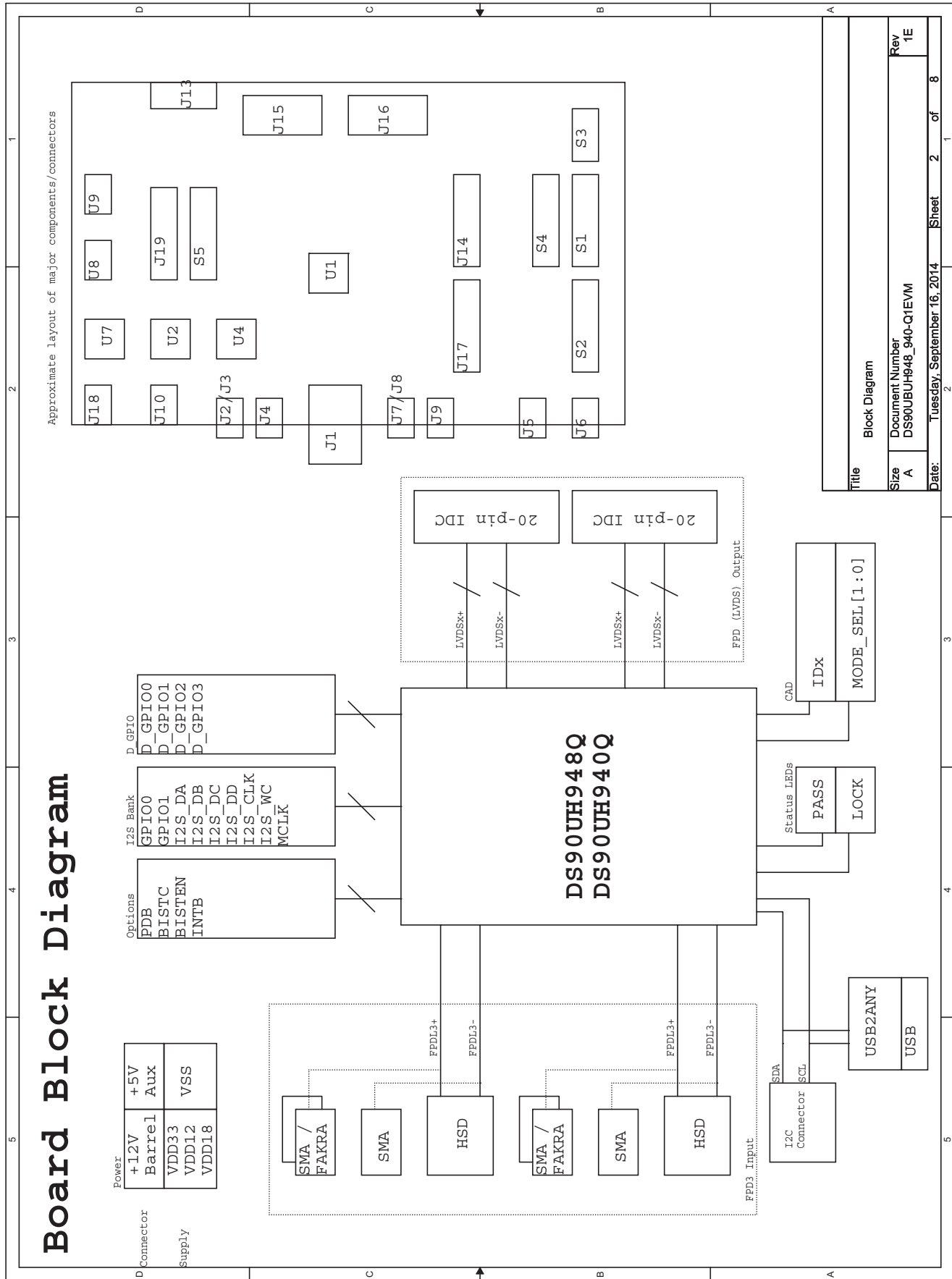
Item	Qty	References	Value	Part Number	Mfr	Description
23	1	C101	2.2nF	CGA2B2X7R1H222K05 0BA	TDK Corporation	CAP CER 2200PF 50V 10% X7R 0402
24	1	D1	1SMB5922	1SMB5922B-13	Diodes Inc	DIODE ZENER 7.5V 3W SMB
25	1	D3	DIODE	B340A-13-F	Diodes Inc	DIODE SCHOTTKY 3A 40V SMA
26	1	F1	FUSE	1206L050/15YR	Littelfuse Inc	PTC RESET 15V .500A SMD 1206
27	2	JP1, JP2	2-Pin Header_open	87220-2_open	AMP/Tyco	CONN HEADER VERT .100 2POS 30AU. DO NOT PURCHASE. DO NOT MOUNT.
28	1	JP3	2-Pin Header_open	87220-2_open	AMP/Tyco	CONN HEADER VERT .100 2POS 30AU. DO NOT PURCHASE. DO NOT POPULATE.
29	7	JP4, JP6, JP7, JP8, JP9, JP10, JP11	2-Pin Header	87220-2	AMP/Tyco	CONN HEADER VERT .100 2POS 30AU
30	2	JP5, JP12	3-Pin Header	87224-3	Tyco	CONN HEADER VERT .100 3POS 15AU
31	1	J1	HSD_2X2	D4S20D-40ML5-Y	Rosenberger	Automotive HSD Connector - Right Angle Plug for PCB.
32	2	J2, J7	FAKRA	59S20X-40ML5-Y_open	Rosenberger	FAKRA-HF PCB RIGHT ANGLE PLUG
33	6	J3, J4, J5, J6, J8, J9	SMA	142-0701-851	Emerson	CONN SMA JACK 50 OHM EDGE MNT
34	1	J10	mini USB 5pin	UX60-MB-5ST	Hirose	CONN RECEPT MINI USB2.0 5POS.
35	1	J11	HEADER 7X2_open	PBC07DFAN_open	Sullins	CONN HEADER .100 DUAL STR 14POS. DO NOT PURCHASE. DO NOT POPULATE.
36	1	J12	HEADER 5X2	PBC05DFAN	Sullins	CONN HEADER .100 DUAL STR 10POS
37	1	J13	IDC1X4	22-11-2042	Molex/Waldom Electronics Corp	CONN HEADER 4POS .100 VERT GOLD
38	1	J14	HEADER 7X2	PBC07DFAN	Sullins	CONN HEADER .100 DUAL STR 14POS
39	2	J15, J16	2X10-Pin Header	N2520-6002RB	3M	CONN HEADER 20 POS STRGHT GOLD.
40	1	J17	2X10-Pin Header	67997-220HLF	FCI	CONN HEADER 20POS .100 STR 15AU
41	1	J18	CONN JACK PWR	PJ-002A	CUI Inc	CONN POWER JACK 2.1MM
42	1	J19	DIP20 SOCKET - MSP430G2403IN20	4820-3004-CP	3M	SOCKET IC OPEN FRAME 20POS .3"
43	1	J20	JTAG-14	AWHW14G-0202-T-R	Assmann	CONN HEADER LOW- PRO 14POS GOLD
44	1	J21	2X2-Pin Header	87227-2	TEC	CONN HEADER VERT .100 4POS 15AU
45	3	LED1, LED4	0603_green_LED	LTST-C191KGKT	LITE-ON INC	LED GREEN CLEAR THIN 0603 SMD
46	1	LED2	0603_orange_LED	LTST-S270KFKT	Lite-On Inc	LED ORANGE CLR RT ANG SMD
47	1	LED3	0603_red_LED	LTST-C190KRKT	LITE-ON INC	LED SUPER RED CLEAR 0603 SMD
48	2	L1, L2	Z = 90 ohm	DLW21SN900HQ2L	Murata	CHOKE COIL COMMON MODE 280MA SMD. DO NOT PURCHASE. DO NOT POPULATE.
49	1	L3	BK1608HS600-T	BK1608HS600-T	Taiyo Yuden	FERRITE BEAD 60 OHM 0603
50	1	L4	15uH	SDR1806-150ML	Bourns Inc.	INDUCTOR POWER 15UH SMD

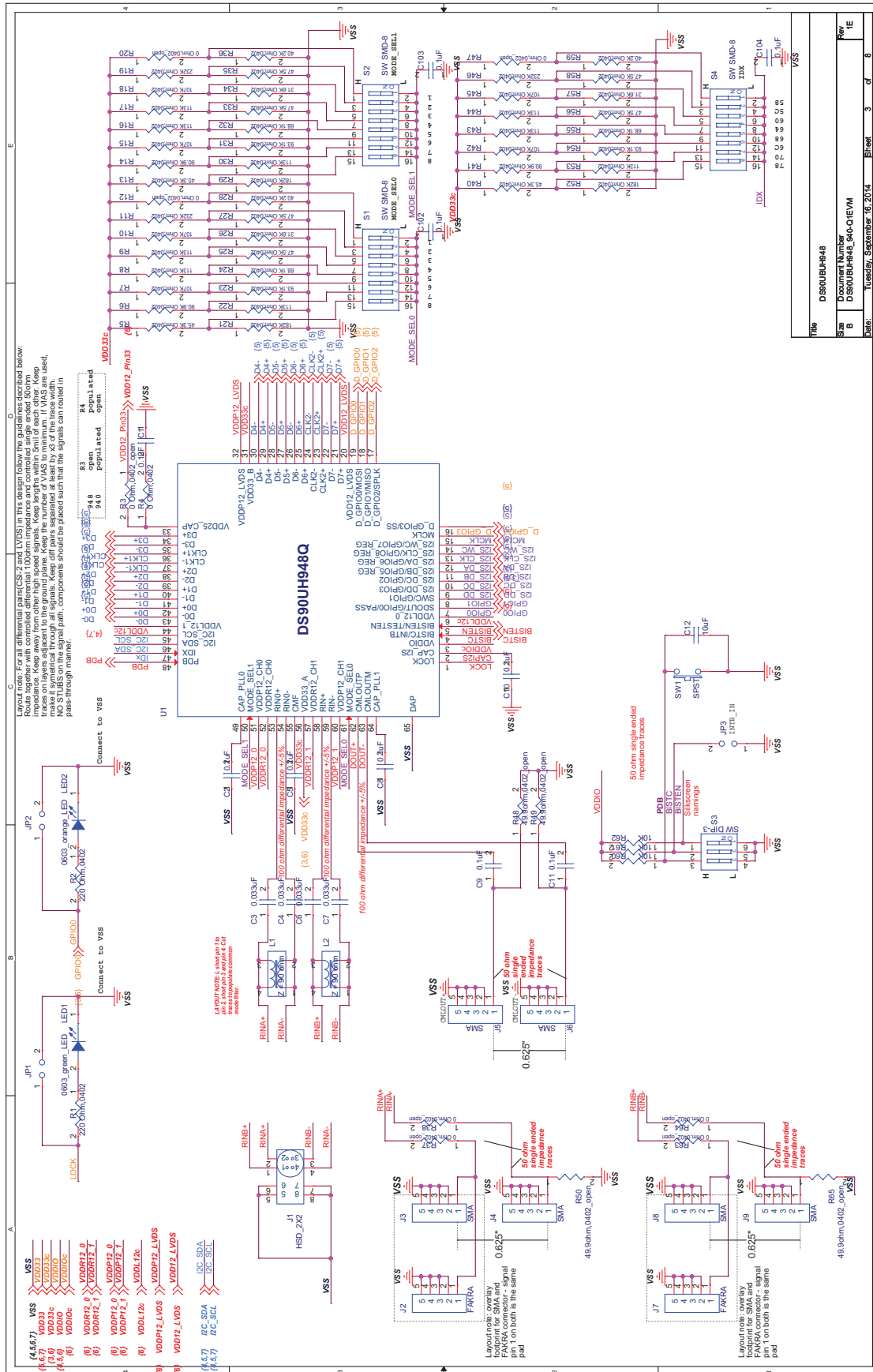
Item	Qty	References	Value	Part Number	Mfr	Description
51	2	L5, L11	FB 1K@100MHz,0603	MPZ1608S102A	TDK Corporation	FERRITE CHIP BEAD 1000 OHM 0603
52	5	L6, L7, L8, L9, L10	FB 120@100MHz,0603	BLM18SG121TN1D	Murata Electronics	FILTER CHIP 120 OHM 3A 0603
53	1	Q1	BSS138	BSS138	Fairchild	MOSFET N-CH 50V 220MA SOT-23
54	4	R1, R2, R75, R98	220 Ohm,0402	ERJ-2GEJ221X	Panasonic	RES 220 OHM 1/10W 5% 0402 SMD
55	13	R12, R20, R37, R38, R47, R63, R64,R73, R74, R87, R91, R109, R120	0 Ohm,0402_open	ERJ-2GEJ0R00X_open	Panasonic	RES ZERO OHM 1/16W 5% 0402 SMD. DO NOT PURCHASE, DO NOT LOAD.
56	2	R3, R4				RES 0.0 OHM 1/10W JUMP 0402 SMD
57	4	R97, R107, R115, R116	0 Ohm,0402	ERJ-2GEJ0R00X	Panasonic	RES 0.0 OHM 1/10W JUMP 0402 SMD
58	3	R5, R13, R40	45.3K Ohm,0402	ERJ-2RKF4532X	Panasonic	RES 45.3k OHM 1/10W 1% 0402 SMD
59	3	R6, R14, R41	90.9K Ohm,0402	ERJ-2RKF9092X	Panasonic	RES 90.9K OHM 1/10W 1% 0402 SMD
60	4	R7, R15, R18, R42	107K Ohm,0402	ERJ-2RKF1073X	Panasonic	RES 107K OHM 1/10W 1% 0402 SMD
61	9	R8,R9,R16,R17,R22, R30,R43,R44,R53	113K Ohm,0402	ERJ-2RKF1133X	Panasonic	RES 113K OHM 1/10W 1% 0402 SMD
62	2	R10,R45	107K Ohm,0402	ERJ-2RKF1073X	Panasonic	RES 107K OHM 1/10W 1% 0402 SMD
63	3	R11,R19,R46	232K Ohm,0402	ERJ-2RKF2323X	Panasonic	RES 232K OHM 1/10W 1% 0402 SMD
64	3	R21,R29,R52	182K Ohm,0402	ERJ-2RKF1823X	Panasonic	RES 182K OHM 1/10W 1% 0402 SMD
65	3	R23,R31,R54	93.1K Ohm,0402	ERJ-2RKF9312X	Panasonic	RES 93.1K OHM 1/10W 1% 0402 SMD
66	3	R24,R32,R55	68.1K Ohm,0402	ERJ-2RKF6812X	Panasonic	RES 68.1K OHM 1/10W 1% 0402 SMD
67	6	R25,R27,R33,R35,R56, R58	47.5K Ohm,0402	ERJ-2RKF4752X	Panasonic	RES 47.5K OHM 1/10W 1% 0402 SMD
68	3	R26,R34,R57	31.6K Ohm,0402	ERJ-2RKF3162X	Panasonic	RES 31.6K OHM 1/10W 1% 0402 SMD
69	3	R28,R36,R59	40.2K Ohm,0402	ERJ-2RKF4022X	Panasonic	RES 40.2K OHM 1/10W 1% 0402 SMD
70	4	R48, R49, R50, R65	49.9ohm,0402_open	ERJ-2RKF49R9X_open	Panasonic	RES 49.9 OHM 1/10W 1% 0402 SMD. DO NOT PURCHASE. DO NOT POPULATE.
71	5	R60, R61, R62, R76, R77	10K	ERJ-3EKF1002V	Panasonic	RES 10.0K OHM 1/10W 1% 0603 SMD
72	2	R66, R67	33 ohm	ERJ-3GEYJ330V	Panasonic	RES 33 OHM 1/10W 5% 0603 SMD
73	5	R68, R99, R103, R113, R117	0 Ohm, 0603	ERJ-3GEY0R00V	Panasonic	RES 0.0 OHM 1/10W JUMP 0603 SMD
74	3	R69, R78, R79	1.5K	ERJ-3GEYJ152V	Panasonic	RES 1.5K OHM 1/10W 5% 0603 SMD
75	2	R70, R72	33K ohm	ERJ-3GEYJ333V	Panasonic	RES 33K OHM 1/10W 5% 0603 SMD
76	1	R71	1.2M ohm	ERJ-3GEYJ125V	Panasonic	RES 1.2M OHM 1/10W 5% 0603 SMD
77	10	R80, R86, R88, R89,R90, R92, R93, R94,R95, R96	100_open	ERJ-2GEJ101X_open	Panasonic	RES 100 OHM 1/10W 5% 0402 SMD. DO NOT PURCHASE. DO NOT POPULATE.
78	2	R81, R82	4.7K	ERJ-3GEYJ472V	Panasonic	RES 4.7K OHM 1/10W 5% 0603 SMD
79	3	R83, R84, R85	0 Ohm	ERJ-2GEJ0R00X	Panasonic	RES 0.0 OHM 1/10W JUMP 0402 SMD
80	1	R100	52.3Kohm	ERJ-6ENF5232V	Panasonic	RES 52.3K OHM 1/8W 1% 0805 SMD

Item	Qty	References	Value	Part Number	Mfr	Description
81	1	R101	9.53Kohm	RG2012P-9531-B-T5	Panasonic	RES 9.53K OHM 1/8W .1% 0805 SMD
82	1	R102	3.09Kohm	ERJ-6ENF3091V	Panasonic	RES 3.09K OHM 1/8W 1% 0805 SMD
83	1	R104	2.49K	ERJ-3EKF2491V	Panasonic	RES 2.49K OHM 1/10W 1% 0603 SMD
84	3	R105, R111, R114	100K	ERJ-3EKF1003V	Panasonic	RES 100K OHM 1/10W 1% 0603 SMD
85	1	R106	1K	ERJ-3EKF1001V	Panasonic	RES 1.0K OHM 1/10W 1% 0603 SMD
86	1	R108	4.99K	ERJ-3EKF4991V	Panasonic	RES 4.99K OHM 1/10W 1% 0603 SMD
87	1	R110	23.2K	ERJ-2RKF2322X	Panasonic	RES 23.2K OHM 1/10W 1% 0402 SMD
88	1	R112	12.1K	ERJ-2RKF1212X	Panasonic	RES 12.1K OHM 1/10W 1% 0402 SMD
89	1	R118	330ohm	ERJ-2RKF3300X	Panasonic	RES 330 OHM 1/10W 1% 0402 SMD
90	1	R119	47Kohm	ERA-3AEB473V	Panasonic	RES 47K OHM 1/16W .1% 0603 SMD
91	3	SW1, SW2, SW3	SPST	ADTSM31NV	APEM Components	SWITCH TACTILE SPST-NO 0.05A 12V
92	4	S1, S2, S4, S5	SW SMD-8	219-8MST	CTS Electrocomponents	SWITCH TAPE SEAL 8 POS SMD 50V
93	1	S3	SW DIP-3	78B03ST	Grayhill	SWITCH DIP EXTENDED SEALED 3POS
94	12	TP1, TP2, TP3, TP4, TP5, TP6, TP7, TP8, TP9, TP10, TP11, TP12	TEST POINT			TEST POINT. NOT A COMPONENT
95	1	U1	DS90UH948-Q1 DS90UB948-Q1	DS90UH948-Q1 DS90UB948-Q1	TI	DS90UH948-Q1 DS90UB948-Q1
96	1	U2	TPS73533DRB	TPS73533DRBT	TI	IC REG LDO 3.3V 0.5A 8SON
97	1	U3	TPD4E004DRY	TPD4E004DRYR	TI	IC 4CH ESD-PROT ARRAY 6-SON
98	1	U4	MSP430F5529IPN	MSP430F5529IPN	TI	IC MCU 16BIT 128K FLASH 80LQFP
99	1	U5	TXB0106IPWR	TXB0106PWR	TI	IC 6BIT NON-INV TRANSLTR 16TSSOP
100	1	U6	TCA9406DCUR	TCA9406DCUR	TI	IC V-LEVEL XLATR I2C/SMBUS US8
101	1	U7	LM25576MH/NOPB	LM25576MH/NOPB	TI	IC REG BUCK ADJ 3A 20TSSOP
102	1	U8	TPS74801DRC	TPS74801DRCT	TI	IC REG LDO ADJ 1.5A 10SON
103	1	U9	TPS767D318PWP	TPS767D318PWP	TI	IC REG LDO 1.8V/3.3V 1A 28HTSSOP
104	1	Y1	Crystal, SMT Quart Crystal	ECS-240-20-5PX-TR	ECS	CRYSTAL 24.000MHZ 20PF SMD
105		DS90UX948_940-Q1EVM Rev1E Brd PCB		SV601029	TI	DS90UH948-Q1EVM DS90UB948-Q1EVM

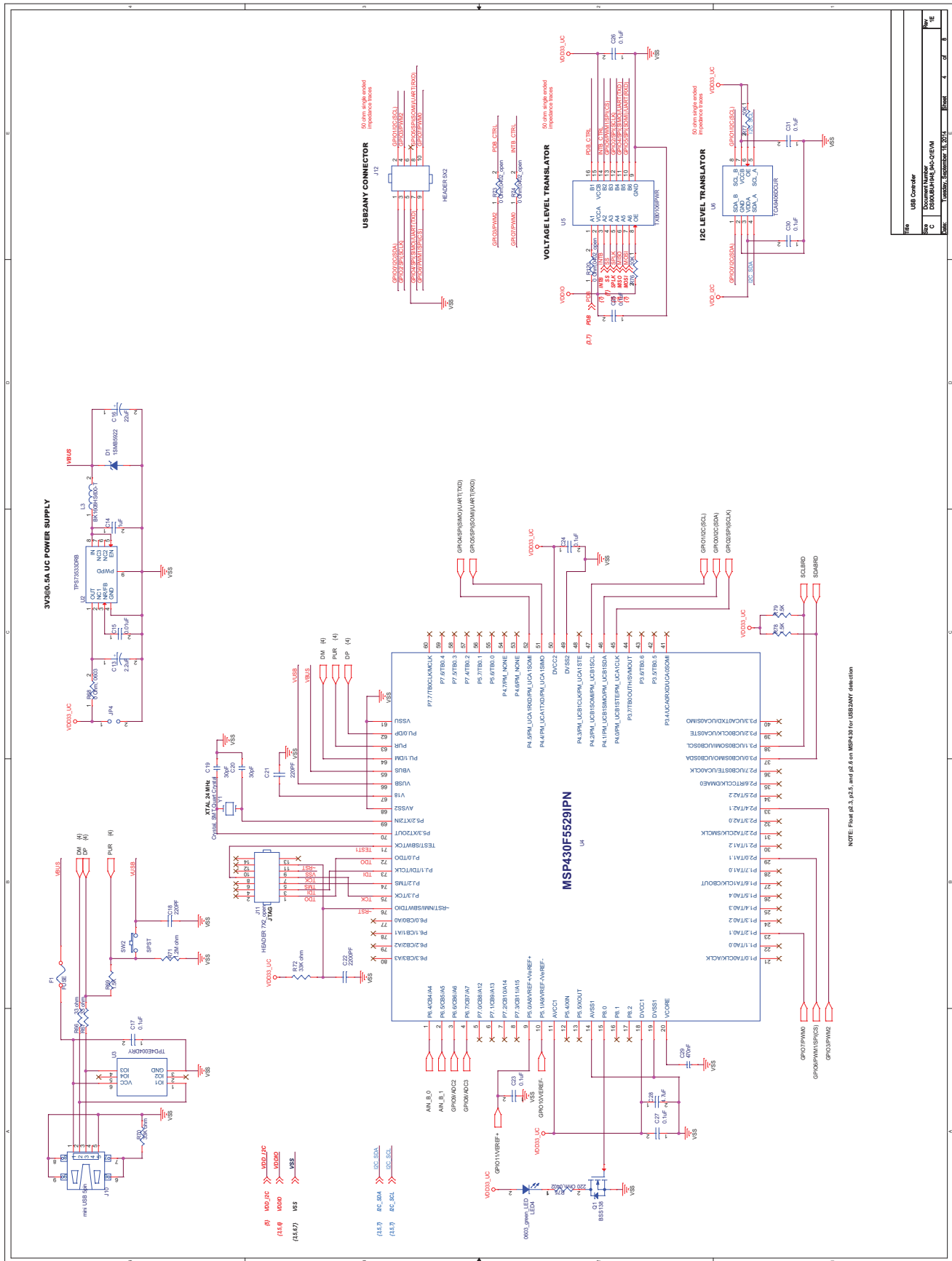
## EVM PCB Schematics

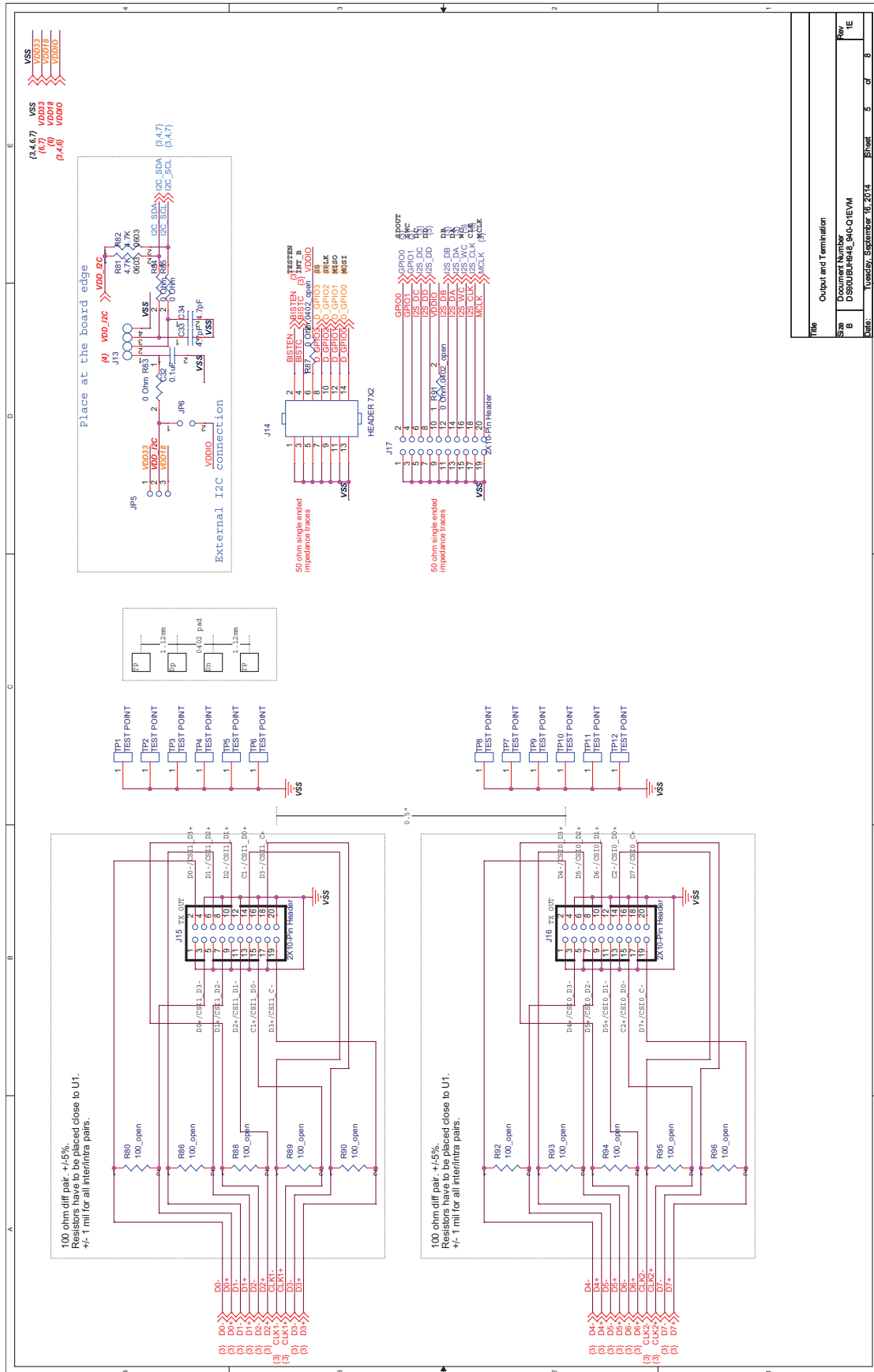










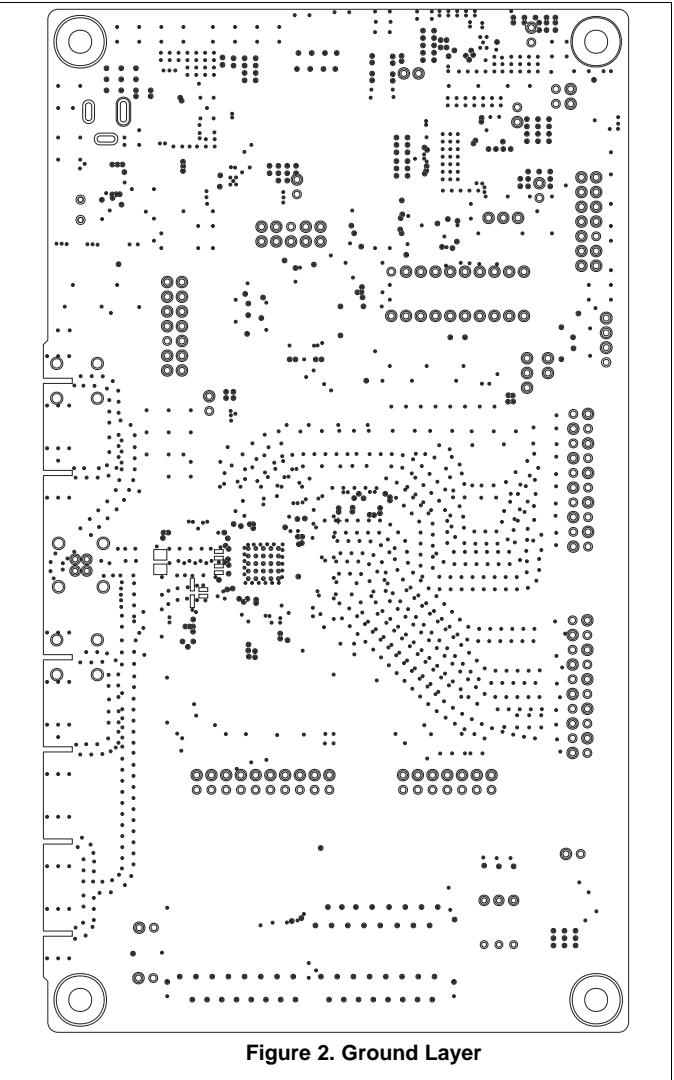
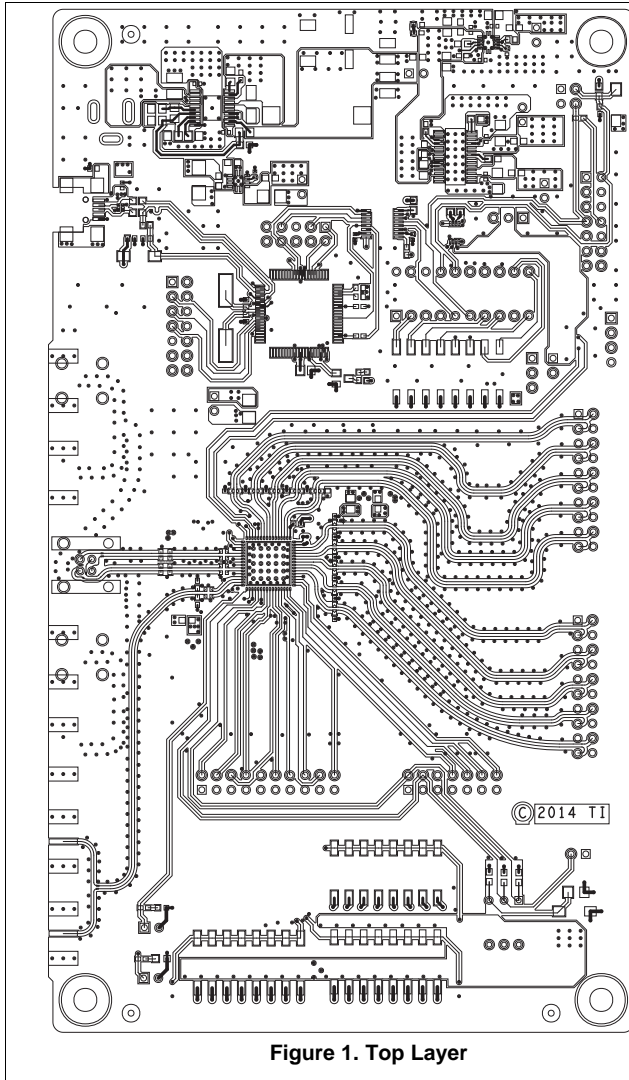


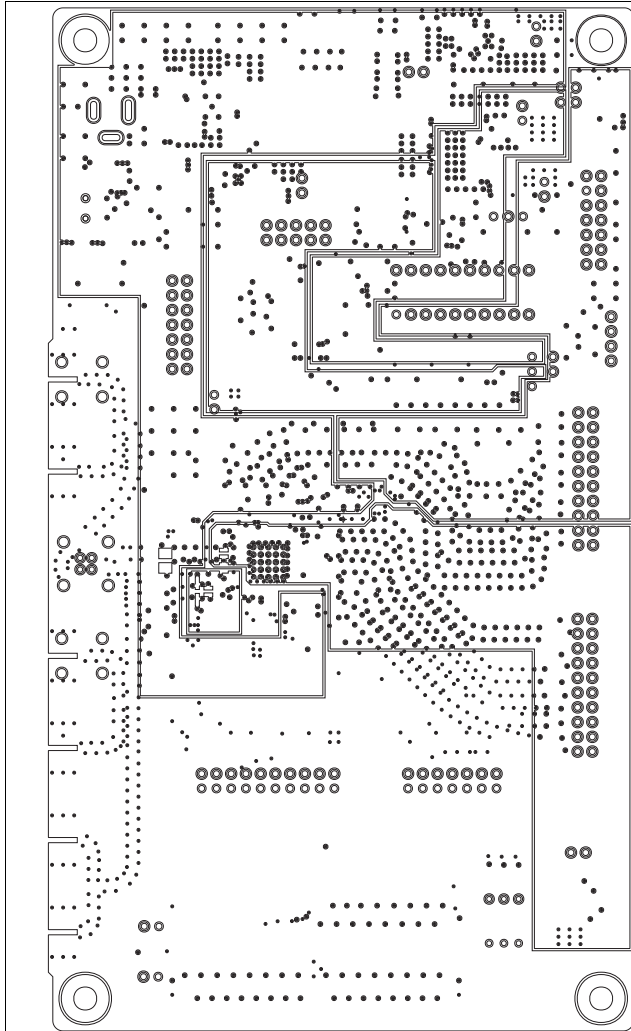




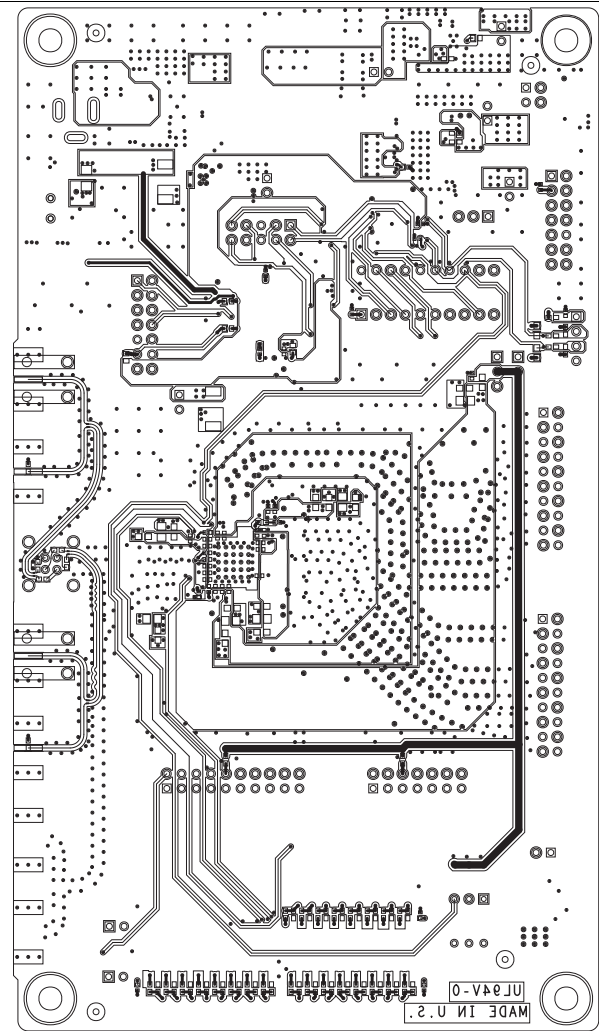
## Board Layout

### Board Layers

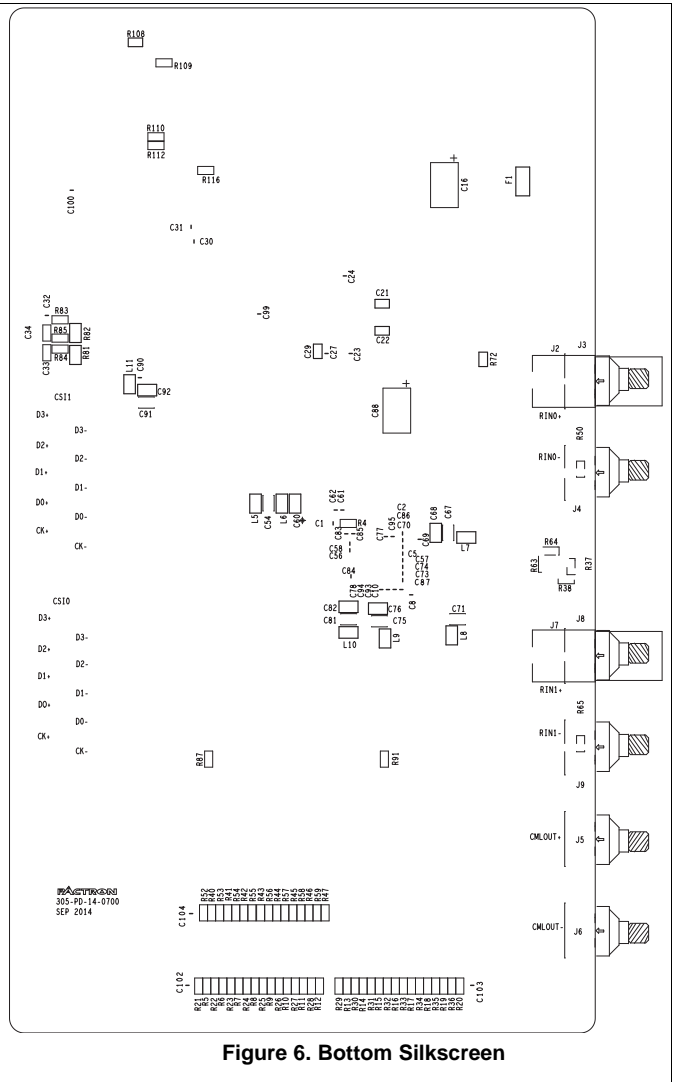
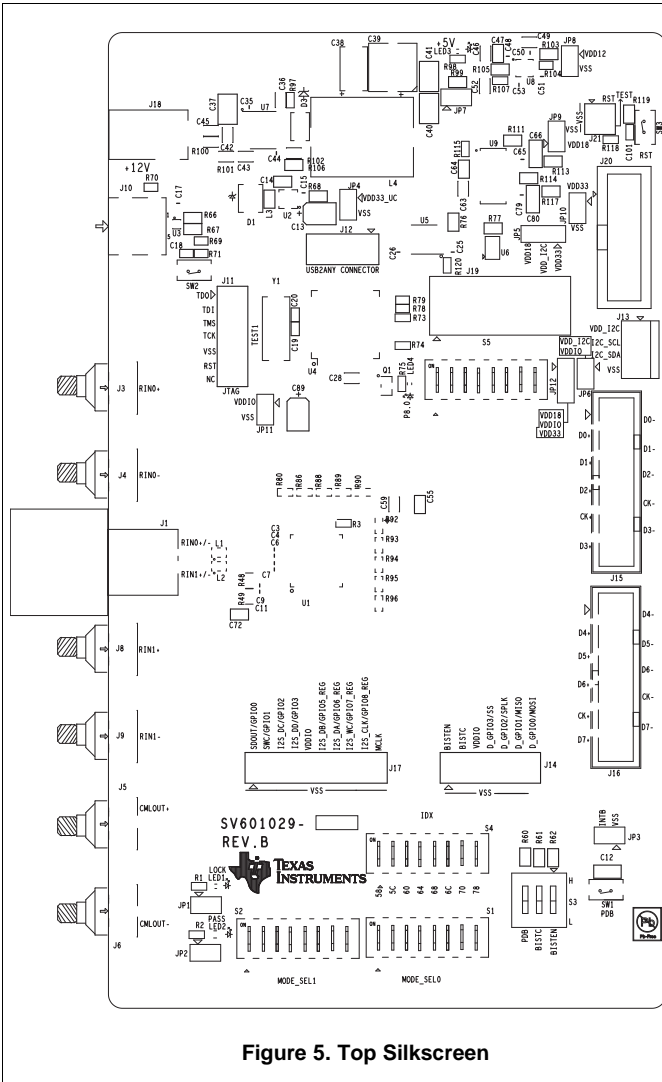




**Figure 3. Power Layer**



**Figure 4. Bottom Layer**







## STANDARD TERMS AND CONDITIONS FOR EVALUATION MODULES

1. *Delivery:* TI delivers TI evaluation boards, kits, or modules, including any accompanying demonstration software, components, or documentation (collectively, an "EVM" or "EVMs") to the User ("User") in accordance with the terms and conditions set forth herein. Acceptance of the EVM is expressly subject to the following terms and conditions.
  - 1.1 EVMs are intended solely for product or software developers for use in a research and development setting to facilitate feasibility evaluation, experimentation, or scientific analysis of TI semiconductor products. EVMs have no direct function and are not finished products. EVMs shall not be directly or indirectly assembled as a part or subassembly in any finished product. For clarification, any software or software tools provided with the EVM ("Software") shall not be subject to the terms and conditions set forth herein but rather shall be subject to the applicable terms and conditions that accompany such Software
  - 1.2 EVMs are not intended for consumer or household use. EVMs may not be sold, sublicensed, leased, rented, loaned, assigned, or otherwise distributed for commercial purposes by Users, in whole or in part, or used in any finished product or production system.
2. *Limited Warranty and Related Remedies/Disclaimers:*
  - 2.1 These terms and conditions do not apply to Software. The warranty, if any, for Software is covered in the applicable Software License Agreement.
  - 2.2 TI warrants that the TI EVM will conform to TI's published specifications for ninety (90) days after the date TI delivers such EVM to User. Notwithstanding the foregoing, TI shall not be liable for any defects that are caused by neglect, misuse or mistreatment by an entity other than TI, including improper installation or testing, or for any EVMs that have been altered or modified in any way by an entity other than TI. Moreover, TI shall not be liable for any defects that result from User's design, specifications or instructions for such EVMs. Testing and other quality control techniques are used to the extent TI deems necessary or as mandated by government requirements. TI does not test all parameters of each EVM.
  - 2.3 If any EVM fails to conform to the warranty set forth above, TI's sole liability shall be at its option to repair or replace such EVM, or credit User's account for such EVM. TI's liability under this warranty shall be limited to EVMs that are returned during the warranty period to the address designated by TI and that are determined by TI not to conform to such warranty. If TI elects to repair or replace such EVM, TI shall have a reasonable time to repair such EVM or provide replacements. Repaired EVMs shall be warranted for the remainder of the original warranty period. Replaced EVMs shall be warranted for a new full ninety (90) day warranty period.
3. *Regulatory Notices:*
  - 3.1 *United States*
    - 3.1.1 *Notice applicable to EVMs not FCC-Approved:*

This kit is designed to allow product developers to evaluate electronic components, circuitry, or software associated with the kit to determine whether to incorporate such items in a finished product and software developers to write software applications for use with the end product. This kit is not a finished product and when assembled may not be resold or otherwise marketed unless all required FCC equipment authorizations are first obtained. Operation is subject to the condition that this product not cause harmful interference to licensed radio stations and that this product accept harmful interference. Unless the assembled kit is designed to operate under part 15, part 18 or part 95 of this chapter, the operator of the kit must operate under the authority of an FCC license holder or must secure an experimental authorization under part 5 of this chapter.
    - 3.1.2 *For EVMs annotated as FCC – FEDERAL COMMUNICATIONS COMMISSION Part 15 Compliant:*

### CAUTION

This device complies with part 15 of the FCC Rules. Operation is subject to the following two conditions: (1) This device may not cause harmful interference, and (2) this device must accept any interference received, including interference that may cause undesired operation.

Changes or modifications not expressly approved by the party responsible for compliance could void the user's authority to operate the equipment.

### FCC Interference Statement for Class A EVM devices

*NOTE: This equipment has been tested and found to comply with the limits for a Class A digital device, pursuant to part 15 of the FCC Rules. These limits are designed to provide reasonable protection against harmful interference when the equipment is operated in a commercial environment. This equipment generates, uses, and can radiate radio frequency energy and, if not installed and used in accordance with the instruction manual, may cause harmful interference to radio communications. Operation of this equipment in a residential area is likely to cause harmful interference in which case the user will be required to correct the interference at his own expense.*

## FCC Interference Statement for Class B EVM devices

*NOTE: This equipment has been tested and found to comply with the limits for a Class B digital device, pursuant to part 15 of the FCC Rules. These limits are designed to provide reasonable protection against harmful interference in a residential installation. This equipment generates, uses and can radiate radio frequency energy and, if not installed and used in accordance with the instructions, may cause harmful interference to radio communications. However, there is no guarantee that interference will not occur in a particular installation. If this equipment does cause harmful interference to radio or television reception, which can be determined by turning the equipment off and on, the user is encouraged to try to correct the interference by one or more of the following measures:*

- Reorient or relocate the receiving antenna.
- Increase the separation between the equipment and receiver.
- Connect the equipment into an outlet on a circuit different from that to which the receiver is connected.
- Consult the dealer or an experienced radio/TV technician for help.

### 3.2 Canada

3.2.1 For EVMs issued with an Industry Canada Certificate of Conformance to RSS-210

#### Concerning EVMs Including Radio Transmitters:

This device complies with Industry Canada license-exempt RSS standard(s). Operation is subject to the following two conditions: (1) this device may not cause interference, and (2) this device must accept any interference, including interference that may cause undesired operation of the device.

#### Concernant les EVMs avec appareils radio:

Le présent appareil est conforme aux CNR d'Industrie Canada applicables aux appareils radio exempts de licence. L'exploitation est autorisée aux deux conditions suivantes: (1) l'appareil ne doit pas produire de brouillage, et (2) l'utilisateur de l'appareil doit accepter tout brouillage radioélectrique subi, même si le brouillage est susceptible d'en compromettre le fonctionnement.

#### Concerning EVMs Including Detachable Antennas:

Under Industry Canada regulations, this radio transmitter may only operate using an antenna of a type and maximum (or lesser) gain approved for the transmitter by Industry Canada. To reduce potential radio interference to other users, the antenna type and its gain should be so chosen that the equivalent isotropically radiated power (e.i.r.p.) is not more than that necessary for successful communication. This radio transmitter has been approved by Industry Canada to operate with the antenna types listed in the user guide with the maximum permissible gain and required antenna impedance for each antenna type indicated. Antenna types not included in this list, having a gain greater than the maximum gain indicated for that type, are strictly prohibited for use with this device.

#### Concernant les EVMs avec antennes détachables

Conformément à la réglementation d'Industrie Canada, le présent émetteur radio peut fonctionner avec une antenne d'un type et d'un gain maximal (ou inférieur) approuvé pour l'émetteur par Industrie Canada. Dans le but de réduire les risques de brouillage radioélectrique à l'intention des autres utilisateurs, il faut choisir le type d'antenne et son gain de sorte que la puissance isotrope rayonnée équivalente (p.i.r.e.) ne dépasse pas l'intensité nécessaire à l'établissement d'une communication satisfaisante. Le présent émetteur radio a été approuvé par Industrie Canada pour fonctionner avec les types d'antenne énumérés dans le manuel d'usage et ayant un gain admissible maximal et l'impédance requise pour chaque type d'antenne. Les types d'antenne non inclus dans cette liste, ou dont le gain est supérieur au gain maximal indiqué, sont strictement interdits pour l'exploitation de l'émetteur.

### 3.3 Japan

3.3.1 *Notice for EVMs delivered in Japan:* Please see [http://www.tij.co.jp/lstds/ti\\_ja/general/eStore/notice\\_01.page](http://www.tij.co.jp/lstds/ti_ja/general/eStore/notice_01.page) 日本国内に輸入される評価用キット、ボードについては、次のところをご覧ください。  
[http://www.tij.co.jp/lstds/ti\\_ja/general/eStore/notice\\_01.page](http://www.tij.co.jp/lstds/ti_ja/general/eStore/notice_01.page)

3.3.2 *Notice for Users of EVMs Considered "Radio Frequency Products" in Japan:* EVMs entering Japan are NOT certified by TI as conforming to Technical Regulations of Radio Law of Japan.

If User uses EVMs in Japan, User is required by Radio Law of Japan to follow the instructions below with respect to EVMs:

1. Use EVMs in a shielded room or any other test facility as defined in the notification #173 issued by Ministry of Internal Affairs and Communications on March 28, 2006, based on Sub-section 1.1 of Article 6 of the Ministry's Rule for Enforcement of Radio Law of Japan,
2. Use EVMs only after User obtains the license of Test Radio Station as provided in Radio Law of Japan with respect to EVMs, or
3. Use of EVMs only after User obtains the Technical Regulations Conformity Certification as provided in Radio Law of Japan with respect to EVMs. Also, do not transfer EVMs, unless User gives the same notice above to the transferee. Please note that if User does not follow the instructions above, User will be subject to penalties of Radio Law of Japan.

**【無線電波を送信する製品の開発キットをお使いになる際の注意事項】**

本開発キットは技術基準適合証明を受けておりません。

本製品のご使用に際しては、電波法遵守のため、以下のいずれかの措置を取っていただく必要がありますのでご注意ください。

1. 電波法施行規則第6条第1項第1号に基づく平成18年3月28日総務省告示第173号で定められた電波暗室等の試験設備でご使用いただく。
2. 実験局の免許を取得後ご使用いただく。
3. 技術基準適合証明を取得後ご使用いただく。

なお、本製品は、上記の「ご使用にあたっての注意」を譲渡先、移転先に通知しない限り、譲渡、移転できないものとします。

上記を遵守頂けない場合は、電波法の罰則が適用される可能性があることをご留意ください。

日本テキサス・インスツルメンツ株式会社

東京都新宿区西新宿 6 丁目 2 4 番 1 号

西新宿三井ビル

3.3.3 *Notice for EVMs for Power Line Communication:* Please see [http://www.tij.co.jp/llds/ti\\_ja/general/eStore/notice\\_02.page](http://www.tij.co.jp/llds/ti_ja/general/eStore/notice_02.page)

電力線搬送波通信についての開発キットをお使いになる際の注意事項については、次のところをご覧ください。[http://www.tij.co.jp/llds/ti\\_ja/general/eStore/notice\\_02.page](http://www.tij.co.jp/llds/ti_ja/general/eStore/notice_02.page)

4 *EVM Use Restrictions and Warnings:*

4.1 EVMS ARE NOT FOR USE IN FUNCTIONAL SAFETY AND/OR SAFETY CRITICAL EVALUATIONS, INCLUDING BUT NOT LIMITED TO EVALUATIONS OF LIFE SUPPORT APPLICATIONS.

4.2 User must read and apply the user guide and other available documentation provided by TI regarding the EVM prior to handling or using the EVM, including without limitation any warning or restriction notices. The notices contain important safety information related to, for example, temperatures and voltages.

4.3 *Safety-Related Warnings and Restrictions:*

4.3.1 User shall operate the EVM within TI's recommended specifications and environmental considerations stated in the user guide, other available documentation provided by TI, and any other applicable requirements and employ reasonable and customary safeguards. Exceeding the specified performance ratings and specifications (including but not limited to input and output voltage, current, power, and environmental ranges) for the EVM may cause personal injury or death, or property damage. If there are questions concerning performance ratings and specifications, User should contact a TI field representative prior to connecting interface electronics including input power and intended loads. Any loads applied outside of the specified output range may also result in unintended and/or inaccurate operation and/or possible permanent damage to the EVM and/or interface electronics. Please consult the EVM user guide prior to connecting any load to the EVM output. If there is uncertainty as to the load specification, please contact a TI field representative. During normal operation, even with the inputs and outputs kept within the specified allowable ranges, some circuit components may have elevated case temperatures. These components include but are not limited to linear regulators, switching transistors, pass transistors, current sense resistors, and heat sinks, which can be identified using the information in the associated documentation. When working with the EVM, please be aware that the EVM may become very warm.

4.3.2 EVMs are intended solely for use by technically qualified, professional electronics experts who are familiar with the dangers and application risks associated with handling electrical mechanical components, systems, and subsystems. User assumes all responsibility and liability for proper and safe handling and use of the EVM by User or its employees, affiliates, contractors or designees. User assumes all responsibility and liability to ensure that any interfaces (electronic and/or mechanical) between the EVM and any human body are designed with suitable isolation and means to safely limit accessible leakage currents to minimize the risk of electrical shock hazard. User assumes all responsibility and liability for any improper or unsafe handling or use of the EVM by User or its employees, affiliates, contractors or designees.

4.4 User assumes all responsibility and liability to determine whether the EVM is subject to any applicable international, federal, state, or local laws and regulations related to User's handling and use of the EVM and, if applicable, User assumes all responsibility and liability for compliance in all respects with such laws and regulations. User assumes all responsibility and liability for proper disposal and recycling of the EVM consistent with all applicable international, federal, state, and local requirements.

5. *Accuracy of Information:* To the extent TI provides information on the availability and function of EVMs, TI attempts to be as accurate as possible. However, TI does not warrant the accuracy of EVM descriptions, EVM availability or other information on its websites as accurate, complete, reliable, current, or error-free.

6. *Disclaimers:*
- 6.1 EXCEPT AS SET FORTH ABOVE, EVMS AND ANY WRITTEN DESIGN MATERIALS PROVIDED WITH THE EVM (AND THE DESIGN OF THE EVM ITSELF) ARE PROVIDED "AS IS" AND "WITH ALL FAULTS." TI DISCLAIMS ALL OTHER WARRANTIES, EXPRESS OR IMPLIED, REGARDING SUCH ITEMS, INCLUDING BUT NOT LIMITED TO ANY IMPLIED WARRANTIES OF MERCHANTABILITY OR FITNESS FOR A PARTICULAR PURPOSE OR NON-INFRINGEMENT OF ANY THIRD PARTY PATENTS, COPYRIGHTS, TRADE SECRETS OR OTHER INTELLECTUAL PROPERTY RIGHTS.
- 6.2 EXCEPT FOR THE LIMITED RIGHT TO USE THE EVM SET FORTH HEREIN, NOTHING IN THESE TERMS AND CONDITIONS SHALL BE CONSTRUED AS GRANTING OR CONFERRING ANY RIGHTS BY LICENSE, PATENT, OR ANY OTHER INDUSTRIAL OR INTELLECTUAL PROPERTY RIGHT OF TI, ITS SUPPLIERS/LICENSORS OR ANY OTHER THIRD PARTY, TO USE THE EVM IN ANY FINISHED END-USER OR READY-TO-USE FINAL PRODUCT, OR FOR ANY INVENTION, DISCOVERY OR IMPROVEMENT MADE, CONCEIVED OR ACQUIRED PRIOR TO OR AFTER DELIVERY OF THE EVM.
7. *USER'S INDEMNITY OBLIGATIONS AND REPRESENTATIONS.* USER WILL DEFEND, INDEMNIFY AND HOLD TI, ITS LICENSORS AND THEIR REPRESENTATIVES HARMLESS FROM AND AGAINST ANY AND ALL CLAIMS, DAMAGES, LOSSES, EXPENSES, COSTS AND LIABILITIES (COLLECTIVELY, "CLAIMS") ARISING OUT OF OR IN CONNECTION WITH ANY HANDLING OR USE OF THE EVM THAT IS NOT IN ACCORDANCE WITH THESE TERMS AND CONDITIONS. THIS OBLIGATION SHALL APPLY WHETHER CLAIMS ARISE UNDER STATUTE, REGULATION, OR THE LAW OF TORT, CONTRACT OR ANY OTHER LEGAL THEORY, AND EVEN IF THE EVM FAILS TO PERFORM AS DESCRIBED OR EXPECTED.
8. *Limitations on Damages and Liability:*
- 8.1 *General Limitations.* IN NO EVENT SHALL TI BE LIABLE FOR ANY SPECIAL, COLLATERAL, INDIRECT, PUNITIVE, INCIDENTAL, CONSEQUENTIAL, OR EXEMPLARY DAMAGES IN CONNECTION WITH OR ARISING OUT OF THESE TERMS AND CONDITIONS OR THE USE OF THE EVMS PROVIDED HEREUNDER, REGARDLESS OF WHETHER TI HAS BEEN ADVISED OF THE POSSIBILITY OF SUCH DAMAGES. EXCLUDED DAMAGES INCLUDE, BUT ARE NOT LIMITED TO, COST OF REMOVAL OR REINSTALLATION, ANCILLARY COSTS TO THE PROCUREMENT OF SUBSTITUTE GOODS OR SERVICES, RETESTING, OUTSIDE COMPUTER TIME, LABOR COSTS, LOSS OF GOODWILL, LOSS OF PROFITS, LOSS OF SAVINGS, LOSS OF USE, LOSS OF DATA, OR BUSINESS INTERRUPTION. NO CLAIM, SUIT OR ACTION SHALL BE BROUGHT AGAINST TI MORE THAN ONE YEAR AFTER THE RELATED CAUSE OF ACTION HAS OCCURRED.
- 8.2 *Specific Limitations.* IN NO EVENT SHALL TI'S AGGREGATE LIABILITY FROM ANY WARRANTY OR OTHER OBLIGATION ARISING OUT OF OR IN CONNECTION WITH THESE TERMS AND CONDITIONS, OR ANY USE OF ANY TI EVM PROVIDED HEREUNDER, EXCEED THE TOTAL AMOUNT PAID TO TI FOR THE PARTICULAR UNITS SOLD UNDER THESE TERMS AND CONDITIONS WITH RESPECT TO WHICH LOSSES OR DAMAGES ARE CLAIMED. THE EXISTENCE OF MORE THAN ONE CLAIM AGAINST THE PARTICULAR UNITS SOLD TO USER UNDER THESE TERMS AND CONDITIONS SHALL NOT ENLARGE OR EXTEND THIS LIMIT.
9. *Return Policy.* Except as otherwise provided, TI does not offer any refunds, returns, or exchanges. Furthermore, no return of EVM(s) will be accepted if the package has been opened and no return of the EVM(s) will be accepted if they are damaged or otherwise not in a resalable condition. If User feels it has been incorrectly charged for the EVM(s) it ordered or that delivery violates the applicable order, User should contact TI. All refunds will be made in full within thirty (30) working days from the return of the components(s), excluding any postage or packaging costs.
10. *Governing Law:* These terms and conditions shall be governed by and interpreted in accordance with the laws of the State of Texas, without reference to conflict-of-laws principles. User agrees that non-exclusive jurisdiction for any dispute arising out of or relating to these terms and conditions lies within courts located in the State of Texas and consents to venue in Dallas County, Texas. Notwithstanding the foregoing, any judgment may be enforced in any United States or foreign court, and TI may seek injunctive relief in any United States or foreign court.

## IMPORTANT NOTICE

Texas Instruments Incorporated and its subsidiaries (TI) reserve the right to make corrections, enhancements, improvements and other changes to its semiconductor products and services per JESD46, latest issue, and to discontinue any product or service per JESD48, latest issue. Buyers should obtain the latest relevant information before placing orders and should verify that such information is current and complete. All semiconductor products (also referred to herein as "components") are sold subject to TI's terms and conditions of sale supplied at the time of order acknowledgment.

TI warrants performance of its components to the specifications applicable at the time of sale, in accordance with the warranty in TI's terms and conditions of sale of semiconductor products. Testing and other quality control techniques are used to the extent TI deems necessary to support this warranty. Except where mandated by applicable law, testing of all parameters of each component is not necessarily performed.

TI assumes no liability for applications assistance or the design of Buyers' products. Buyers are responsible for their products and applications using TI components. To minimize the risks associated with Buyers' products and applications, Buyers should provide adequate design and operating safeguards.

TI does not warrant or represent that any license, either express or implied, is granted under any patent right, copyright, mask work right, or other intellectual property right relating to any combination, machine, or process in which TI components or services are used. Information published by TI regarding third-party products or services does not constitute a license to use such products or services or a warranty or endorsement thereof. Use of such information may require a license from a third party under the patents or other intellectual property of the third party, or a license from TI under the patents or other intellectual property of TI.

Reproduction of significant portions of TI information in TI data books or data sheets is permissible only if reproduction is without alteration and is accompanied by all associated warranties, conditions, limitations, and notices. TI is not responsible or liable for such altered documentation. Information of third parties may be subject to additional restrictions.

Resale of TI components or services with statements different from or beyond the parameters stated by TI for that component or service voids all express and any implied warranties for the associated TI component or service and is an unfair and deceptive business practice. TI is not responsible or liable for any such statements.

Buyer acknowledges and agrees that it is solely responsible for compliance with all legal, regulatory and safety-related requirements concerning its products, and any use of TI components in its applications, notwithstanding any applications-related information or support that may be provided by TI. Buyer represents and agrees that it has all the necessary expertise to create and implement safeguards which anticipate dangerous consequences of failures, monitor failures and their consequences, lessen the likelihood of failures that might cause harm and take appropriate remedial actions. Buyer will fully indemnify TI and its representatives against any damages arising out of the use of any TI components in safety-critical applications.

In some cases, TI components may be promoted specifically to facilitate safety-related applications. With such components, TI's goal is to help enable customers to design and create their own end-product solutions that meet applicable functional safety standards and requirements. Nonetheless, such components are subject to these terms.

No TI components are authorized for use in FDA Class III (or similar life-critical medical equipment) unless authorized officers of the parties have executed a special agreement specifically governing such use.

Only those TI components which TI has specifically designated as military grade or "enhanced plastic" are designed and intended for use in military/aerospace applications or environments. Buyer acknowledges and agrees that any military or aerospace use of TI components which have **not** been so designated is solely at the Buyer's risk, and that Buyer is solely responsible for compliance with all legal and regulatory requirements in connection with such use.

TI has specifically designated certain components as meeting ISO/TS16949 requirements, mainly for automotive use. In any case of use of non-designated products, TI will not be responsible for any failure to meet ISO/TS16949.

### Products

Audio	<a href="http://www.ti.com/audio">www.ti.com/audio</a>
Amplifiers	<a href="http://amplifier.ti.com">amplifier.ti.com</a>
Data Converters	<a href="http://dataconverter.ti.com">dataconverter.ti.com</a>
DLP® Products	<a href="http://www.dlp.com">www.dlp.com</a>
DSP	<a href="http://dsp.ti.com">dsp.ti.com</a>
Clocks and Timers	<a href="http://www.ti.com/clocks">www.ti.com/clocks</a>
Interface	<a href="http://interface.ti.com">interface.ti.com</a>
Logic	<a href="http://logic.ti.com">logic.ti.com</a>
Power Mgmt	<a href="http://power.ti.com">power.ti.com</a>
Microcontrollers	<a href="http://microcontroller.ti.com">microcontroller.ti.com</a>
RFID	<a href="http://www.ti-rfid.com">www.ti-rfid.com</a>
OMAP Applications Processors	<a href="http://www.ti.com/omap">www.ti.com/omap</a>
Wireless Connectivity	<a href="http://www.ti.com/wirelessconnectivity">www.ti.com/wirelessconnectivity</a>

### Applications

Automotive and Transportation	<a href="http://www.ti.com/automotive">www.ti.com/automotive</a>
Communications and Telecom	<a href="http://www.ti.com/communications">www.ti.com/communications</a>
Computers and Peripherals	<a href="http://www.ti.com/computers">www.ti.com/computers</a>
Consumer Electronics	<a href="http://www.ti.com/consumer-apps">www.ti.com/consumer-apps</a>
Energy and Lighting	<a href="http://www.ti.com/energy">www.ti.com/energy</a>
Industrial	<a href="http://www.ti.com/industrial">www.ti.com/industrial</a>
Medical	<a href="http://www.ti.com/medical">www.ti.com/medical</a>
Security	<a href="http://www.ti.com/security">www.ti.com/security</a>
Space, Avionics and Defense	<a href="http://www.ti.com/space-avionics-defense">www.ti.com/space-avionics-defense</a>
Video and Imaging	<a href="http://www.ti.com/video">www.ti.com/video</a>

### TI E2E Community

[e2e.ti.com](http://e2e.ti.com)