

Semiconductor Packing Methodology

Cles Troxtell, Bobby O'Donley, Ray Purdom, and Edgar Zuniga

Standard Linear & Logic

ABSTRACT

The Texas Instruments Semiconductor Group uses three packing methodologies to prepare semiconductor devices for shipment to end users. The methods employed are linked to the device level for shipping configuration keys. End users of the devices often need to peruse many TI and industry publications to understand the shipping configurations. This application report documents TI's three main shipping methods and typical dimensions for end users to review.

Contents

Introduction	3
Background	3
Typical Applications of Each Packing Method	5
Stick Magazine (Shipping Tube) – Primary Component Container	5
Tray – Primary Component Container	8
Tape and Reel – Primary Component Container	10
Moisture Sensitivity	20
Testing for Moisture Sensitivity	20
Dry-Packing Process	21
Dry Packing	21
Typical Packing Method	21
Conclusion	26
Glossary	27
Acknowledgment	28
References	28

List of Figures

1	Single-Stick-Magazine Shipping Tube	3
2	JEDEC Tray	3
3	Reel With Carrier Tape	4
4	Intermediate Packing for PDIP Packages	5
5	Example of Trays Stacked and Bound	8
6	JEDEC Tray With Properly Arranged Units	9
7	Tape-and-Reel Packing	10
8	Carrier-Tape Dimensions	11
9	Carrier Tape Pocket Quadrant Definition	14
10	Rectangular QFP Package Properly Oriented in Carrier Tape	15
11	EIA-783 Guideline, Rules 1 and 2	16
12	EIA-783 Guideline, Rule 3	16
13	Typical TI Component Orientations for Tape-and-Reel Packing	17
14	Typical Reel Outline as Defined by EIA-481-x	18
15	Loaded Reel (Not Moisture Sensitive)	19
16	Standard Box Containing Loaded Reel	19
17	Tray Box and Sealed Moisture-Barrier Bag (Top), Opened Bag and Tray Stack (Bottom)	22
18	Dry-Packed Tape-and-Reel Configuration	23
19	Moisture-Sensitive Identification (MSID) Label	24
20	Moisture-Sensitivity Caution Label (Levels 2a Through 5a)	24
21	Humidity-Indicator Card	25

List of Tables

1	Stick Magazine	6
2	SLL Packages and Standard Quantities	9
3	Tape-and-Reel Packing Configurations	12
4	Floor Life for Different Package Moisture-Sensitivity Levels	21
5	Packing-Material Environmental Coding	25

Introduction

This application report describes in detail the methods used by the TI Standard Linear & Logic (SLL) business unit to pack semiconductor devices (components). This application report provides customers answers to the most frequently asked questions and allows them to review the different methods used to pack our products.

Background

TI ships product in three basic configurations: stick magazine, tray, and tape and reel. The following paragraphs define each packing configuration.

- Stick magazine – The stick magazine (also called shipping tube) was developed in the early days of the integrated circuit (IC) industry. The magazine is used to transport and store electronic components between the manufacturer and the customer and for use in the manufacturing plant. Magazines also are used to feed components to automatic-placement machines for surface and through-hole board mounting. Multiple stick magazines are placed in next-level intermediate containers (boxes and bags) in standard packing quantities. A typical stick magazine is shown in Figure 1.

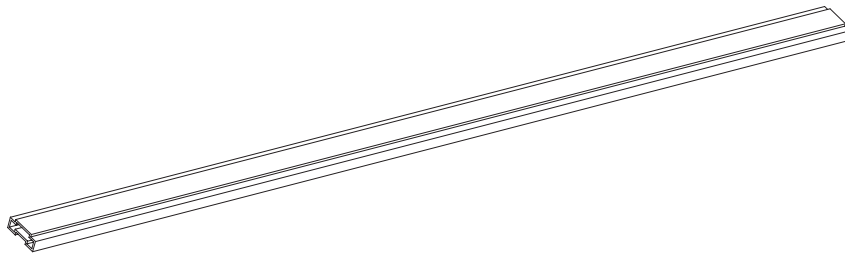

Figure 1. Stick Magazine

- Tray – The IC shipping tray contains the components during component-assembly operations, during transport and storage from the component manufacturing plant to the customer's board-assembly site, and when feeding components to automatic-placement machines for surface mounting on board assemblies. The tray is designed for components that have leads on four sides (QFP and TQFP packages) and require component lead isolation during shipping, handling, or processing. Trays are stacked and bound together to form standard packing configurations. SLL uses only standard JEDEC tray configurations. A typical JEDEC tray is shown in Figure 2.

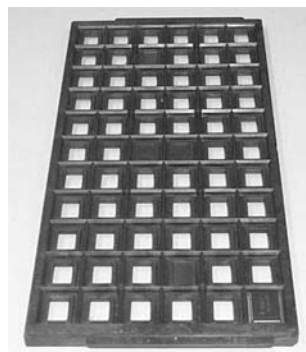

Figure 2. JEDEC Tray

- Tape and reel – The tape-and-reel configuration is used for transport and storage from the manufacturer of the electronic components to the customer, and for use in the customer manufacturing plant. The configuration is designed for feeding components to automatic-placement machines for surface mounting on board assemblies. The configuration can be used for all SMT packages and provides component lead isolation during shipping, handling, and processing. The complete configuration consists of a carrier tape with sequential individual cavities that hold individual components, and a cover tape that seals the carrier tape to retain the components in the cavities. In most cases, single reels of components are inserted into intermediate boxes before shipping. A typical loaded reel is shown in Figure 3.

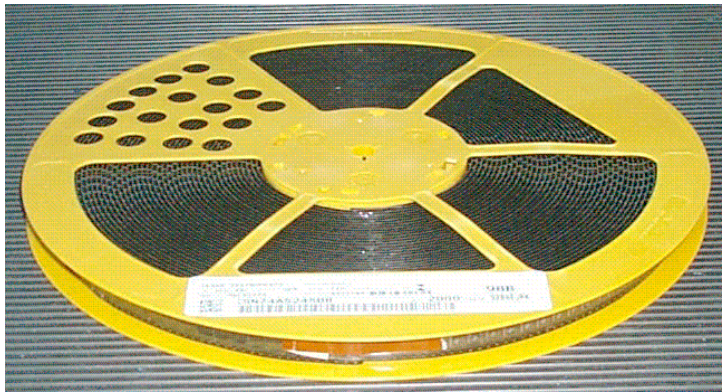

Figure 3. Reel With Carrier Tape

Typical Applications of Each Packing Method

Stick Magazine (Shipping Tube) – Primary Component Container

Stick magazines are constructed of rigid clear or translucent polyvinylchloride (PVC) material.

Stick magazines are extruded in applicable standard outlines that meet current industry standards, and protect components during shipping and handling. The stick-magazine dimensions provide proper component location and orientation for industry-standard automated-assembly equipment.

Stick magazines are packed and shipped in multiples of single magazines. Multiple stick magazines are loaded into intermediate containers (bags and boxes) to form standard quantities, for ease of handling and order simplification. Typical intermediate-level packing quantities for magazines vary by pin count and package type. Figure 4 shows intermediate-level packing for PDIP packages. Stick magazine packing quantities are included in Table 1.

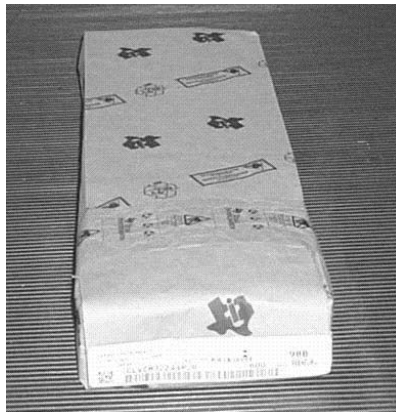

Figure 4. Intermediate Packing for PDIP Packages

Table 1. Stick Magazine

Package Type	Pin-Count Package Designator	Quantity Per Magazine	Container Standard Quantity	Sectional Shape (mm)	Magazine Length (mm)	Wall Thickness (mm)	Pin or Plug Shape and Dimensions (mm)
PDIP (300 mil)	8 P 14 N 16 N 20 N 24 NT 28 NT	50 25 25 20 15 10	1000 1000 1000 1000 750 500		506.1	0.58	
PDIP (600 mil)	24 N	15	750		507.0	0.56	
SOP (JEDEC, narrow body)	8 D 14 D 16 D	75 50 40	1500 1000 1000		507.0	0.55	
SOP (JEDEC, wide body)	16 DW 20 DW 24 DW 28 DW	40 25 25 20	1000 1000 1000 1000		507.0	0.76	
SOP (EIAJ)	8 PS 14 NS 16 NS 20 NS 24NS	80 50 50 40 34	1040 1000 1000 1000 1020		530.0	0.55	
SSOP (narrow body, pitch ≤1 mm)	28 DB 30 DB 38 DB	50 50 40	1000 1000 1000				
SSOP (wide body, pitch ≤1 mm)	28 DL 48 DL 56 DL	40 25 20	1000 1000 1000		473.7	0.64	

Table 1. Magazine (Continued)

Package Type	Pin-Count Package Designator	Quantity Per Magazine	Container Standard Quantity	Sectional Shape (mm)	Magazine Length (mm)	Wall Thickness (mm)	Pin or Plug Shape and Dimensions (mm)																				
TSSOP (narrow body, pitch ≤1 mm, max height ≤1.20 mm)	8 PW	150	1500		530.0	0.60																					
	14 PW	90	1080					1080																			
TSSOP (wide body, pitch ≤1 mm, max height ≤1.20 mm)	16 PW	90	1080		530.0	0.60																					
	20 PW	70	1050					1050																			
PLCC (square)	24 PW	60	1200		497.3	0.64																					
	48 DGG	40	1000					1015																			
PLCC (square)	56 DGG	35	1015	<table border="1"> <thead> <tr> <th></th> <th>20 Pin</th> <th>28 Pin</th> <th>44 Pin</th> </tr> </thead> <tbody> <tr> <td>A</td> <td>10.69</td> <td>12.95</td> <td>18.42</td> </tr> <tr> <td>B</td> <td>5.08</td> <td>5.08</td> <td>5.13</td> </tr> </tbody> </table>		20 Pin	28 Pin	44 Pin	A	10.69	12.95	18.42	B	5.08	5.08	5.13	497.3	0.64	<table border="1"> <thead> <tr> <th></th> <th>20 Pin</th> <th>28 Pin</th> <th>44 Pin</th> </tr> </thead> <tbody> <tr> <td>A</td> <td>8.00</td> <td>12.07</td> <td>17.15</td> </tr> </tbody> </table>		20 Pin	28 Pin	44 Pin	A	8.00	12.07	17.15
		20 Pin	28 Pin		44 Pin																						
A	10.69	12.95	18.42																								
B	5.08	5.08	5.13																								
	20 Pin	28 Pin	44 Pin																								
A	8.00	12.07	17.15																								
44 FN	26	960	960	<table border="1"> <thead> <tr> <th></th> <th>20 Pin</th> <th>28 Pin</th> <th>44 Pin</th> </tr> </thead> <tbody> <tr> <td>A</td> <td>10.69</td> <td>12.95</td> <td>18.42</td> </tr> <tr> <td>B</td> <td>5.08</td> <td>5.08</td> <td>5.13</td> </tr> </tbody> </table>		20 Pin	28 Pin	44 Pin	A	10.69	12.95	18.42	B	5.08	5.08	5.13	497.3	0.64	<table border="1"> <thead> <tr> <th></th> <th>20 Pin</th> <th>28 Pin</th> <th>44 Pin</th> </tr> </thead> <tbody> <tr> <td>A</td> <td>8.00</td> <td>12.07</td> <td>17.15</td> </tr> </tbody> </table>		20 Pin	28 Pin	44 Pin	A	8.00	12.07	17.15
	20 Pin	28 Pin	44 Pin																								
A	10.69	12.95	18.42																								
B	5.08	5.08	5.13																								
	20 Pin	28 Pin	44 Pin																								
A	8.00	12.07	17.15																								

WHITE/CLEAR PIN/PLUG

GREEN PIN/PLUG
PIN 1

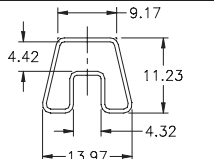
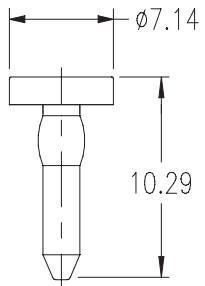
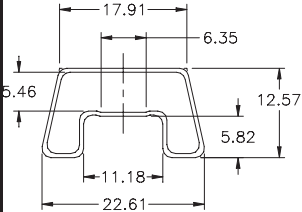
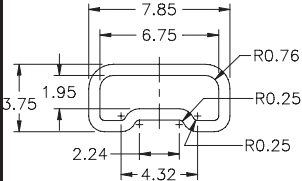
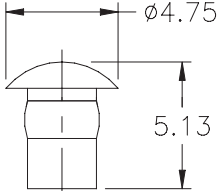
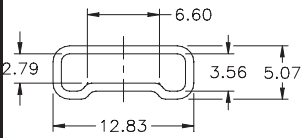
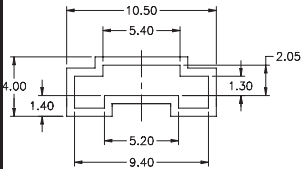
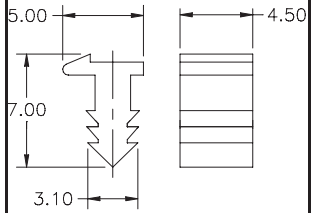
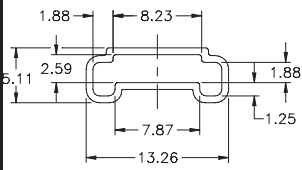
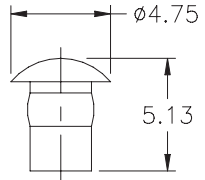
Tray – Primary Component Container

Trays are constructed of carbon-powder or fiber materials that are selected according to the maximum temperature rating of the specific tray. TI trays designed for use on components requiring exposure to high temperatures (moisture-sensitive components) have temperature ratings of 150°C or more.

Trays are molded into rectangular JEDEC standard outlines, containing matrices of uniformly spaced pockets. The pocket protects the component during shipping and handling. The spacing provides exact component locations for standard industry automated-assembly equipment used for pick-and-place in board-assembly processes.

Trays are packed and shipped in multiples of single trays. Trays are stacked and bound together for rigidity. An empty cover tray is added to the top of the loaded and stacked trays. Typical tray stack configurations are five full trays and one cover tray (5 + 1), and ten full trays and one cover tray (10 + 1) (see Figure 5).

Customers can receive units in single or multiple stacks, depending on individual requirements.

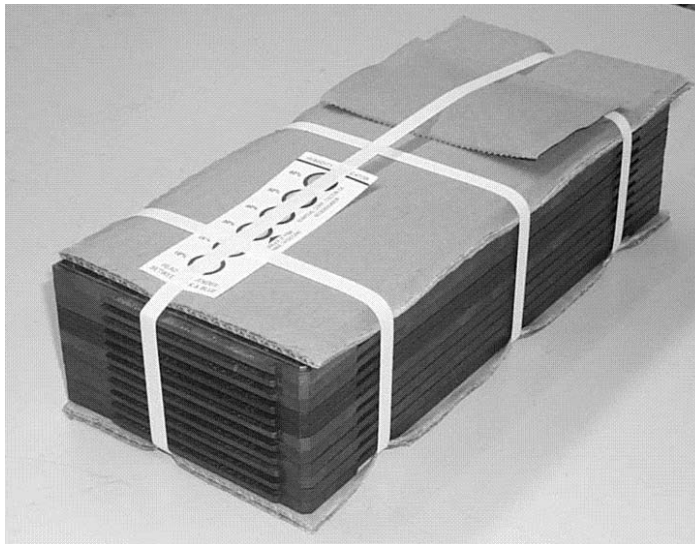

Figure 5. Example of Trays Stacked and Bound

Components are arranged in the trays to match industry standards. TI standard orientation is to place pin 1 at the tray chamfered corner (see Figure 6).



Figure 6. JEDEC Tray With Properly Arranged Units

Standard packing quantities vary by package size. Table 2 lists SLL packages and their standard quantities.

Table 2. SLL Packages and Standard Quantities

PACKAGE TYPE	PACKAGE	PINS	QUANTITY PER TRAY	MATRIX	CONTAINER STANDARD QUANTITY
TQFP	PM	64	160	8 × 20	800
	PN	80	119	7 × 17	495
	PCA	100	90	6 × 15	450
	PZ	100	90	6 × 15	450
QFP	RC	52	96	6 × 16	480

Tape and Reel – Primary Component Container

The tape-and-reel configuration, as shipped by TI, meets current industry standards. EIA-481-1, EIA-481-2, and EIA-481-3 apply to the embossed configurations. EIA-468-B applies to the radial-lead-device configurations.

Embossed Tape and Reel

Most components ordered by customers are delivered in the embossed tape-and-reel configuration. This configuration consists of a carrier tape with a cover tape sealed to it (see Figure 7). This composite tape, loaded with the components, is wound on a reel. The reel is placed in a corrugated shipping box for transport and delivery.

The three components of this packing configuration are the carrier tape, the cover tape, and the reel. A description of each component is provided in the following paragraphs.

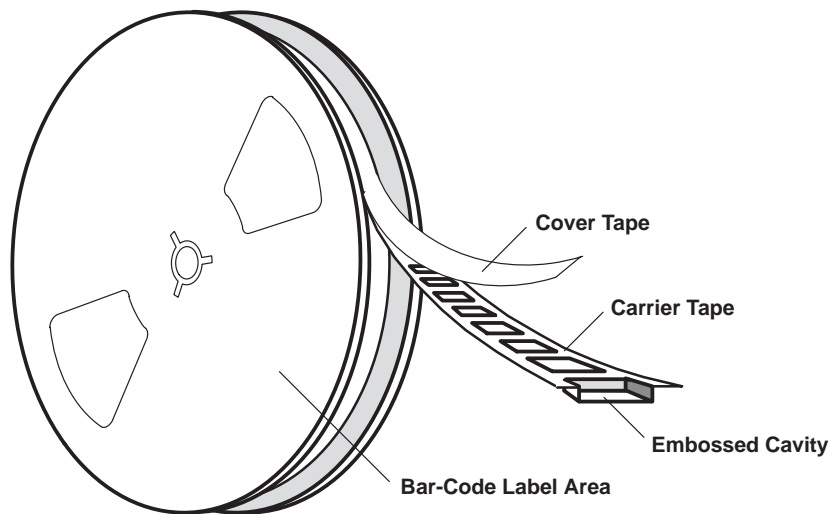

Figure 7. Tape-and-Reel Packing

Carrier Tape

Figure 8 shows the basic outline and dimension labels of the carrier tape. Typically, the carrier tape is constructed from a polystyrene (PS) or PS-laminate film. The uniform film thickness is 0.2 mm to 0.4 mm, depending on the size and weight of the component carried by the tape.

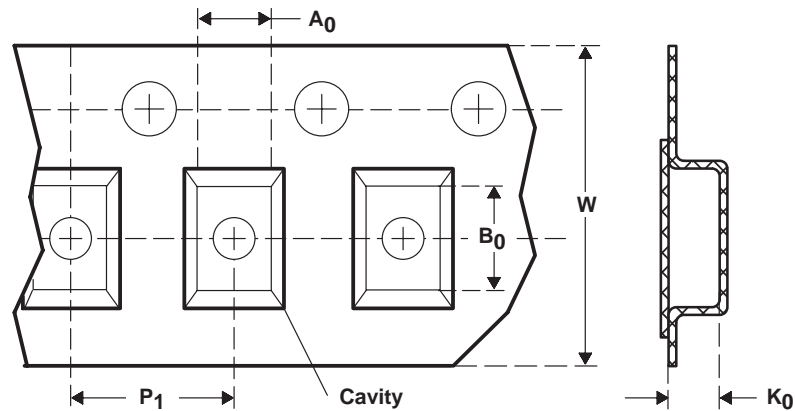

Figure 8. Carrier-Tape Dimensions

Carrier tape design is defined largely by the component length, width, and thickness.

The following component dimensions are the basis for common industry dimension variables for carrier tape:

- A_0 = Dimension designed to accommodate the component width
- B_0 = Dimension designed to accommodate the component length
- K_0 = Dimension designed to accommodate the component thickness. For cavities with bottom pedestals, a K_1 dimension is specified to identify the required pedestal height.
- W = Overall width of the carrier tape. This must conform to accepted industry standards (8/12/16/24/32/44/56 mm).
- P_1 = Pitch between successive cavity centers. This dimension must conform to industry standards (4-mm increments).

Table 3 gives the basic dimensions for SLL packages shipped in the tape-and-reel configuration. The table also shows shipping quantities and pin 1 location of the package relative to carrier tape sprocket holes location.

Table 3. Tape-and-Reel Packing Configurations

FAMILY	PACKAGE	PINS	QUANTITY	REEL DIAMETER (mm)	A ₀ (mm)	B ₀ (mm)	K ₀ (mm)	K ₁ (mm)	P ₁ (mm)	W (mm)	PIN 1 QUADRANT
MicroStar BGA™	ZRDR\GRDR	54	1000	330	5.8	8.3	1.55	0.83	8	16	1
	ZKER\GKER	96	1000	330	5.7	13.7	2	1.2	8	24	
	ZDFR\GKFR	114	1000	330	5.7	16.2	2	1.2	8	24	
MicroStar Jr. BGA™	ZQNR\GQNR	20	1000	330	3.3	4.3	1.6	N/A	8	12	1
	ZQLR\GQLR	56	1000	330	4.8	7.3	1.5	N/A	8	16	
	ZRGR\GRGR	83	1000	330	4.8	10.3	1.8	1	8	24	
NanoStar™	YEAR\YZAR	5,6	3000	178	1.1	1.6	0.56	–	4	8	1
	YEPR\YZPR	8	3000	178	1.1	2.1	0.56	–	4	8	
PLCC	FNR	20	1000	330	10.3	10.3	4.9	3.8	12	16	Midpoint of 1 and 2
		28	750	330	13	13	4.9	3.7	16	24	
		44	500	330	18	18	5.7	4.1	24	32	
PowerFLEX™	KTPR	2	3000	330	6.5	10	2.45	2.2	8	16	2
	KTER	3	2000	330	9.8	11	2.45	2.2	12	24	
	KTGR	5	2000	330	9.8	11	2.45	2.2	12	24	
QFN	Rgyr	14	1000	178	3.8	3.8	1.2	–	8	12	1
		16	1000	178	3.8	4.3	1.2	–	8	12	
		20	1000	178	3.8	4.8	1.2	–	8	12	
		24	1000	178	3.8	5.8	1.2	–	8	12	
	Rgyr	56	2000	330	8.3	8.3	1.1	–	12	16	2
SOIC	DR	8	2500	330	6.4	5.2	2.1	N/A	8	12	1
		14	2500	330	6.5	9	2.1	N/A	8	16	
		16	2500	330	6.5	10.3	2.1	N/A	8	16	
	DWR	16	2000	330	11.1	10.85	2.65	2.35	12	16	
		20	2000	330	11.1	13.35	2.7	2.35	12	24	
		24	2000	330	11.1	15.9	2.7	2.35	12	24	
		28	1000	330	11.35	18.67	3.1	2.44	16	32	
SOP	PSR	8	2000	330	8.2	6.6	2.5	2.1	12	16	1
	NSR	14	2000	330	8.2	10.5	2.5	2.1	12	16	
		16	2000	330	8.2	10.5	2.5	2.1	12	16	
		20	2000	330	8.2	13	2.5	2.1	12	24	
		24	2000	330	8.2	15.7	2.5	2.1	12	24	

MicroStar BGA, MicroStar Jr. BGA, and PowerFLEX are trademarks of Texas Instruments.

Table 3. Tape-and-Reel Packing Configurations (Continued)

FAMILY	PACKAGE	PINS	QUANTITY	REEL DIAMETER (mm)	A ₀ (mm)	B ₀ (mm)	K ₀ (mm)	K ₁ (mm)	P ₁ (mm)	W (mm)	PIN 1 QUADRANT
SSOP	DCTR	8	3000	178	3.15	4.35	1.55	1.25	4	12	3
	DBR	14	2000	330	8.2	6.6	2.5	2.1	12	16	1
		16	2000	330	8.2	6.6	2.5	2.1	12	16	
		20	2000	330	8.2	7.5	2.5	2.1	12	16	
		24	2000	330	8.2	8.8	2.5	2.1	12	16	
		28	2000	330	8.2	10.5	2.5	2.1	12	16	
		30	2000	330	8.2	10.5	2.5	2.1	12	16	
	DL	38	2000	330	8.2	13	2.5	2.1	12	24	
		28	1000	330	11.35	9.78	3.1	2.44	12	24	
		48	1000	330	11.35	16.2	3.1	2.44	16	32	
	DBQR	56	1000	330	11.35	18.67	3.1	2.44	16	32	
		16	2500	330	6.4	5.2	2.1	N/A	8	16	
		20	2500	330	6.5	10.3	2.1	N/A	8	16	
		24	2500	330	6.5	10.3	2.1	N/A	8	16	
SOT	PKR	3	1000	330	4.85	4.52	2.3	1.85	8	12	
	DCYR	4	2500	178	6.9	7.5	2.1	–	8	12	
	DCKR/DCK3	5,6	3000	178	2.24	2.34	1.22	N/A	4	8	
	DCK2/DCK4	5,6	3000	178	2.24	2.34	1.22	N/A	4	8	2
	DBV2/DBV4	5,6	3000	178	2.24	2.34	1.22	N/A	4	8	
	DBVR/DBV3	5,6	3000	178	3.15	3.2	1.4	N/A	4	8	3
	DBZ	3	3000	178	3.15	2.95	1.22	N/A	4	8	3
TQFP	PMR	64	1000	330	12.5	12.5	1.9	1.6	16	24	2
TSSOP	PWR/PWPR	8	2000	330	7	3.6	1.6	1.2	8	12	1
		14	2000	330	7	5.6	1.6	1.2	8	12	
		16	2000	330	7	5.6	1.6	1.2	8	12	
		20	2000	330	6.95	7.1	1.6	1.2	8	16	
		24	2000	330	6.95	8.3	1.6	1.2	8	16	
	DGGR	48	2000	330	8.6	15.8	1.8	1.3	12	24	
		56	2000	330	8.6	15.8	1.8	1.3	12	24	
		64	2000	330	8.4	17.3	1.7	1.2	12	24	
TO	LPR	3	2000	360	N/A	N/A	N/A	N/A	13	18	–
	KTTR	5	1000	330	10.4	16.2	4.95	–	12	24	2

Table 3. Tape-and-Reel Packing Configurations (Continued)

FAMILY	PACKAGE	PINS	QUANTITY	REEL DIAMETER (mm)	A ₀ (mm)	B ₀ (mm)	K ₀ (mm)	K ₁ (mm)	P ₁ (mm)	W (mm)	PIN 1 QUADRANT
TVSOP	DGVR	14	2000	330	6.8	4	1.6	1.2	8	12	1
		16	2000	330	6.8	4	1.6	1.2	8	12	
		20	2000	330	7	5.6	1.6	1.2	8	12	
		24	2000	330	7	5.6	1.6	1.2	8	12	
		48	2000	330	6.8	10.1	1.6	1.2	12	24	
	56	2000	330	6.8	11.7	1.6	1.2	12	24		
	DBBR	80	2000	330	8.4	17.3	1.7	1.2	12	24	
VSSOP	DCUR	8	3000	178	2.25	3.35	1.05	–	4	8	3
	DDUR	8	3000	178	2.25	3.35	1.05	–	4	8	
	DGKR	8	2500	330	5.3	3.4	1.4	–	8	12	1
	DGSR	10	2500	330	5.3	3.4	1.4	–	8	12	

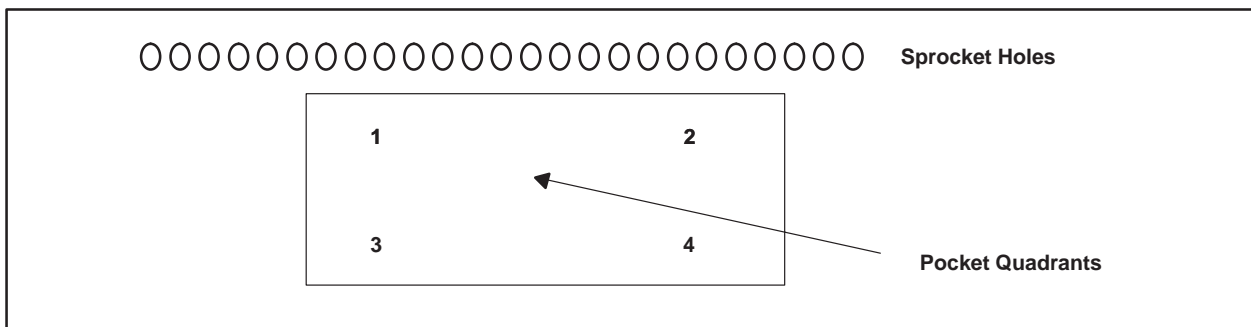

Figure 9. Carrier Tape Pocket Quadrant Definition

MicroStar BGA, MicroStar Jr. BGA, and PowerFLEX are trademarks of Texas Instruments.

Cover Tape

Typically, the cover tape is a PET film or film laminate, with adhesive applied to the underside of the film. Most applications use a heat- and pressure-sensitive adhesive to ensure a positive, consistent seal to the carrier tape. The film thickness, including adhesive, is 50 μm to 65 μm .

A typical rectangular QFP package in the carrier tape pocket with the cover tape sealed, but partially peeled back, is shown in Figure 10. The package is properly oriented in the tape cavity.

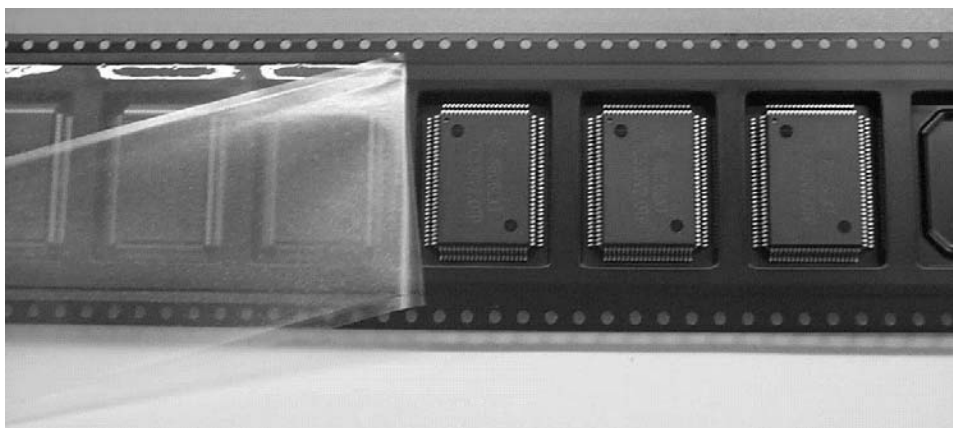

Figure 10. Rectangular QFP Package Properly Oriented in Carrier Tape

Component orientation in the carrier-tape pocket is governed by EIA-783, which states that the following orientation rules shall be followed, sequentially, until no other variation is possible (see Figure 11):

1. The largest axis of the component outline shall be perpendicular to the tape length.
2. The edge of the package containing termination 1 shall be oriented toward the round sprocket holes.
3. For the components where rule 1 and rule 2 do not establish a unique orientation, termination 1 shall be in quadrant 1 (see Figure 12).

Typical TI component orientation is shown in Figure 13.

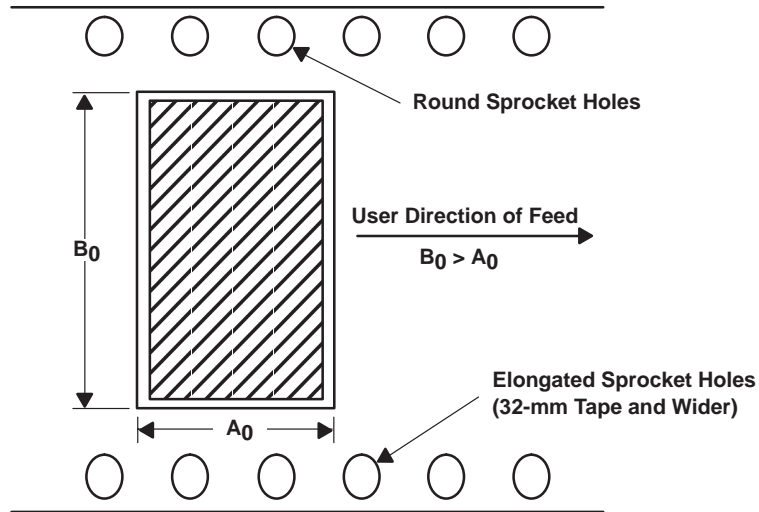

Figure 11. EIA-783 Guideline, Rules 1 and 2

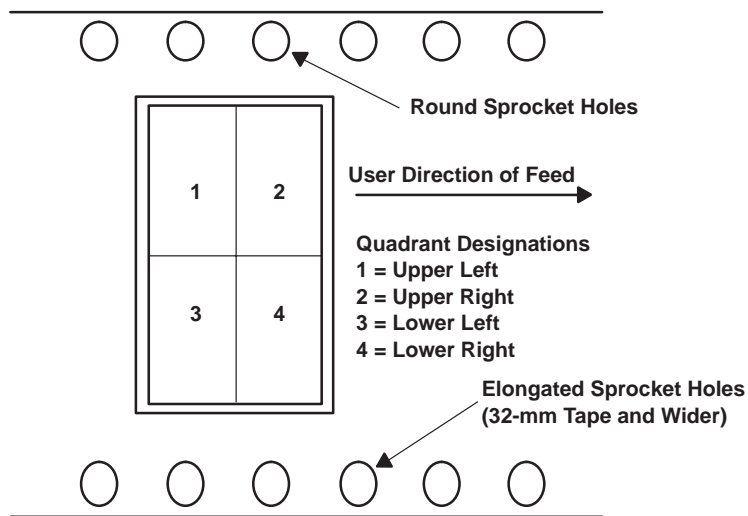
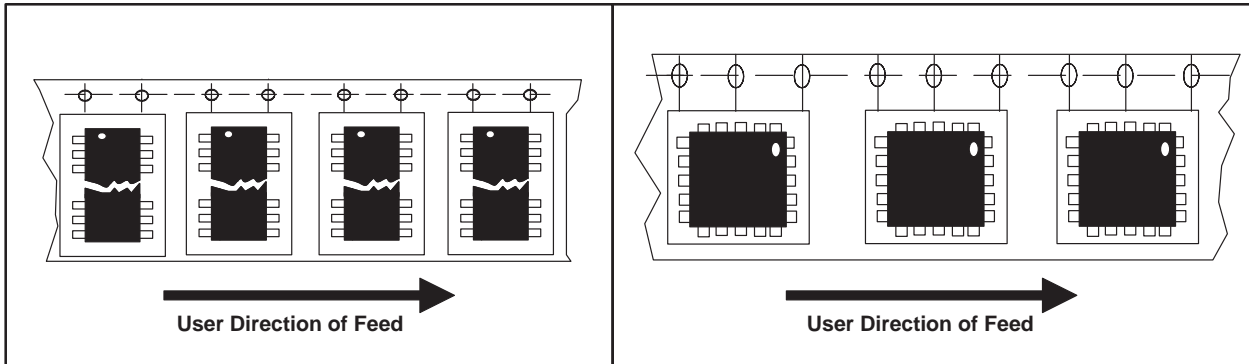

Figure 12. EIA-783 Guideline, Rule 3

TSOP/SOP/SOIC/SSOP/TSSOP/TVSOP/BGA/Rectangular QFP

Square QFP/TQFP/LQFP



SOT-23

TO-220

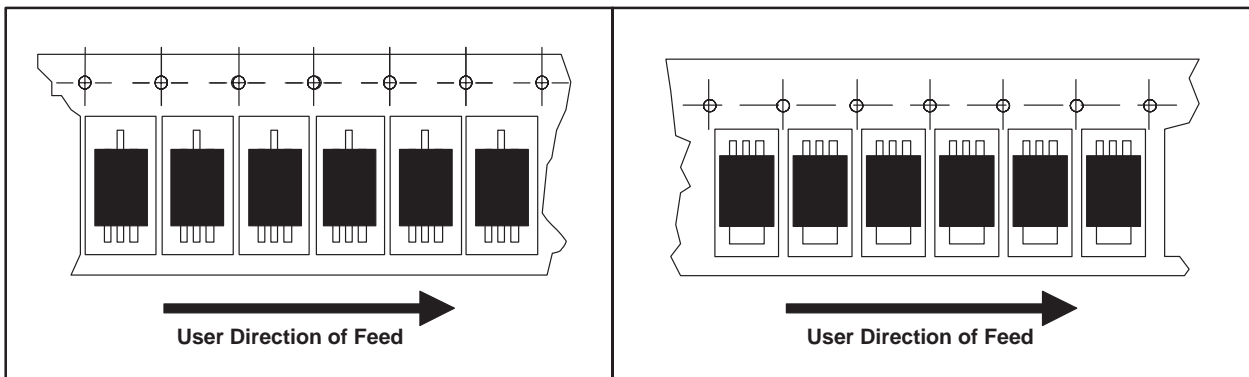

TO-92

TO-89

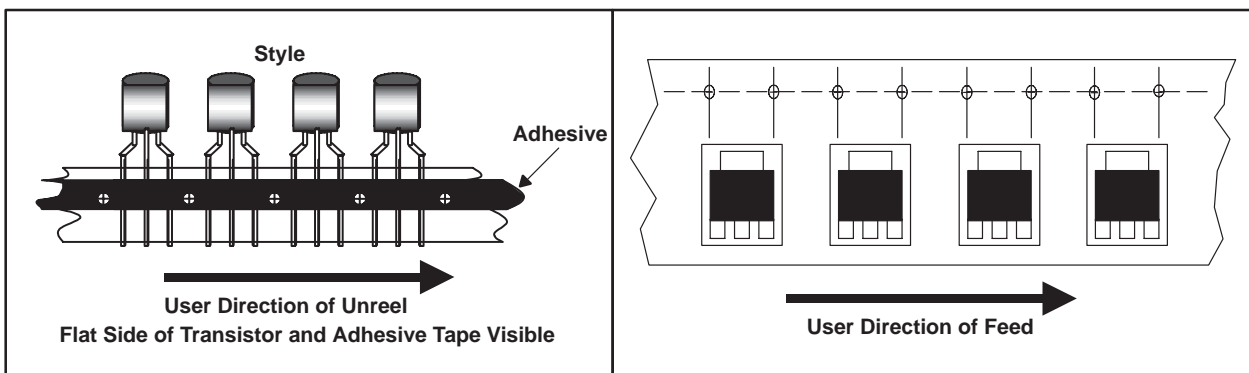

Figure 13. Typical TI Component Orientations for Tape-and-Reel Packing

Reel

Reels that contain the sealed carrier tape are polystyrene (PS). Reels can have one, two, or three parts. Typically, it is blue, but other colors are acceptable. The reels are recyclable, and TI participates in environmentally responsible recycling programs. Customers can receive new or recycled reels. In all cases, recycled reels are required to conform to drawing specifications. Reel dimensions are within the EIA-481-1, EIA-481-2, and EIA-481-3 standards (see Figure 14).

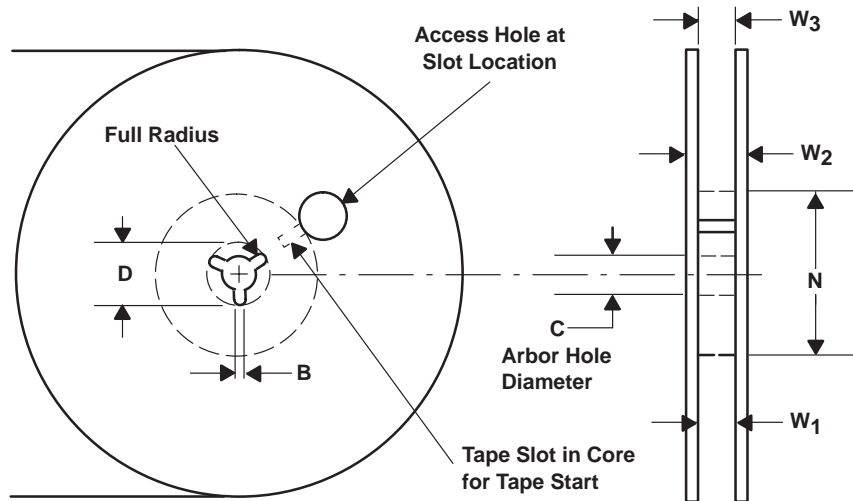

Figure 14. Typical Reel Outline as Defined by EIA-481-x

Examples of tape-and-reel intermediate-level packing are shown in Figures 15 and 16.

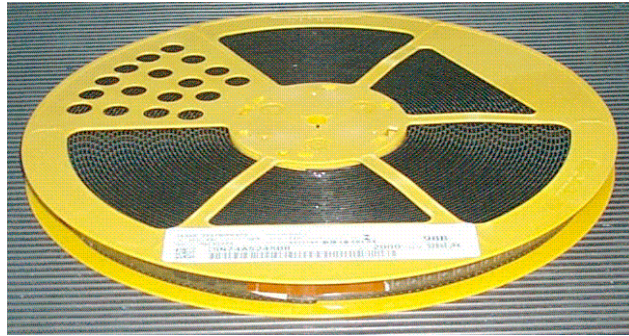

Figure 15. Loaded Reel (Not Moisture Sensitive)



Figure 16. Standard Box Containing Loaded Reel

Moisture Sensitivity

Plastic IC packages absorb moisture from the surrounding environment. This is a typical characteristic of the materials (mold compound and die attach) used in the construction of plastic packages. The moisture inside the package increases or decreases to reach the relative humidity (RH) of the surrounding environment. Weight gain/loss analysis is used to determine the time it takes for a package to reach moisture saturation or the time required for removing it. This information is used to specify maximum exposure times and minimum dry-baking times for a particular package.

Moisture inside the package turns into steam when the package is exposed to the vapor phase/infrared reflow and/or wave-soldering processes that are common in the fabrication of printed circuit boards (PCBs). The resulting steam and vapor pressure can cause cracking of the package, a phenomenon called popcorning.

Testing for Moisture Sensitivity

The sensitivity of a package to moisture-induced damage depends on many factors, including room temperature, relative humidity, and construction of the package. Surface-mount packages are more susceptible to moisture-induced damage than their through-hole counterparts, because surface-mount packages normally are exposed to higher solder temperatures. Through-hole parts usually are larger and, therefore, mechanically stronger.

TI surface-mount products are tested for moisture sensitivity using the procedures outlined in EIA/JEDEC A112-A and EIA/JEDEC A113-B. JEDEC levels 1 through 6 define relative levels of moisture sensitivity. Level 1 denotes a package that is not moisture sensitive. Any package denoted level 2, or higher, requires removal of moisture by baking or under vacuum, followed by dry packing to protect it during shipment. Shipping containers are labeled according to the product moisture-sensitivity classification (see *Moisture-Sensitivity Labeling*). Dry packing and labeling procedures are discussed in the following sections.

SLL packages have been tested and classified according to their sensitivity to moisture-induced damage. The moisture sensitivity classification can be found at the following TI external web link. Just input the product of interest.

<http://focus.ti.com/quality/docs/partnumsearch.tsp?templated=5909&navigationId=11214&ms1Type=true>

TI through-hole packages have not been tested according to JESD 22-A112-A or JESD 22-A113-A standards. Due to the nature of the through-hole PCB soldering process, the component package is shielded from the solder wave by the PCB and is not subjected to the higher reflow temperatures experienced by surface-mount components.

TI through-hole packages are not classified as moisture sensitive.

Dry-Packing Process

If a package is moisture sensitive (level 2 or higher), it must be dry packaged. Normally, in this process, packages are baked for 24 hours at $125^{\circ}\text{C} \pm 5^{\circ}\text{C}$. Baking time could vary depending on the package type.

Dry Packing

Dry packing consists of baking the packages to reduce moisture to a level not to exceed 0.05% by weight. Then, the units are placed in a moisture-barrier bag, along with desiccant, to keep the moisture inside the bag to a level $<20\%$ RH. Each product is labeled as moisture sensitive, outlining the necessary precautions for handling the product. Table 4 shows the floor life for the different package moisture-sensitivity levels.

Table 4. Floor Life for Different Package Moisture-Sensitivity Levels

LEVEL	FLOOR LIFE			SOAK TIME		
	CONDITIONS		TIME	TIME (HOURS)	CONDITIONS	
	TEMPERATURE ($^{\circ}\text{C}$)	RH (%)			TEMPERATURE ($^{\circ}\text{C}$)	RH (%)
1	≤ 30	90	Unlimited	168	85	85
2	≤ 30	60	1 year	168	85	60
				$X + Y = Z$ (see Note)		
3	≤ 30	60	168 hours	$24 + 168 = 192$	30	60
4	≤ 30	60	72 hours	$24 + 72 = 96$	30	60
5	≤ 30	60	24 hours	$24 + 24 = 48$	30	60
6	≤ 30	60	6 hours	$0 + 6 = 6$	30	60

NOTE: X = time between bake and dry bake at the manufacturing site

Y = floor life of package after removal from dry-pack bag

Z = total soak time

The X values are default values. If the actual time exceeds this value, use the actual time and adjust the soak time.

Typical Packing Method

The typical packing method requires the following materials:

- Stick magazines (shipping tubes), trays, tape and reel
- Desiccant
- Moisture-barrier bag
- Labels [moisture-sensitive identification (MSID) label, dry-pack caution label]
- Humidity-indicator card

Examples of tray and tape-and-reel dry pack are shown in Figures 17 and 18.



**Figure 17. Tray Box and Sealed Moisture-Barrier Bag (Top),
Opened Bag and Tray Stack (Bottom)**



Figure 18. Dry-Packed Tape-and-Reel Configuration

Moisture-Sensitivity Labeling

Primary and intermediate containers containing moisture-sensitive packages are labeled as shown in Figures 19 and 20.



Figure 19. Moisture-Sensitive Identification (MSID) Label

The MSID label is applied to the outside of the intermediate container near the TI barcode label. This label indicates that moisture-sensitive packages are inside.

The moisture-sensitivity caution label (see Figure 20) is applied to the reel (for tape-and-reel configurations) and to the outside of the sealed moisture-barrier bag. This label contains detailed information specific to the device (moisture-sensitivity level, floor life, etc.).

	CAUTION	LEVEL
	This bag contains MOISTURE-SENSITIVE DEVICES	
		<input type="checkbox"/> <small>If Blank, see adjacent bar code label</small>
1. Calculated shelf life in sealed bag: 12 months at < 40 °C and < 90% relative humidity (RH)		
2. Peak package body temperature: _____ °C <small>If Blank, see adjacent bar code label</small>		
3. After bag is opened, devices that will be subjected to reflow solder or other high temperature process must		
a) Mounted within: _____ hours of factory <small>If Blank, see adjacent bar code label</small>		
conditions: a) 30 °C/60% b) stored at <10% RH		
4. Devices require bake, before mounting, if:		
a) Humidity Indicator Card is > 10% when read at 23 ± 5 °C b) 3a or 3b not met.		
5. If baking is required, devices may be baked for 48 hours at 125 ± 5 °C		
<small>Note: If device containers cannot be subjected to high temperature or shorter bake times are desired, reference IPC/JEDEC J-STD-033 for bake procedure</small>		
Bag Seal Date: _____ <small>If Blank, see adjacent bar code label</small>		
<small>Note: Level and body temperature defined by IPC/JEDEC J-STD-020</small>		

Figure 20. Moisture-Sensitivity Caution Label (Levels 2a Through 5a)

The humidity-indicator card (see Figure 21) is placed inside the sealed moisture-barrier bag. This card verifies that the product has been stored and shipped in a low-humidity environment.

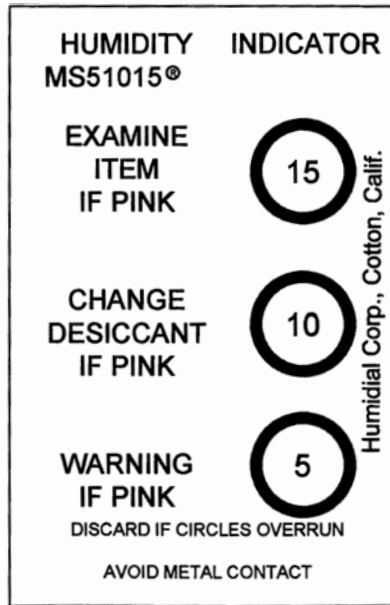

Figure 21. Humidity-Indicator Card

Environmental Issues

TI optimizes the packing density of each configuration to minimize the volume of packing material entering the industrial waste stream. Where possible, TI uses pure materials such as PS/PVC for ease of disposal. Cellulose-material suppliers are encouraged to incorporate recycled material to reduce their consumption of virgin material. Typical packing materials used, and their respective recycling code assignments, are listed in Table 5.

Table 5. Packing-Material Environmental Coding

PACKING MATERIAL	COMPOSITION	RECYCLING CODE
Magazines	PVC	3
End pins/plugs	PVC	3
Trays	PAS/ABS/PPE	7 (other)
Reel	PS	6
Carrier tape	PS	6
Cover tape	PET laminate	7 (other)
Dry-pack bag	PET laminate	7 (other)
Boxes	Kraft corrugated	N/A

Conclusion

TI continually reviews packing configurations to ensure alignment with current industry trends and requirements. TI strives to deliver products to customers that are easily introduced into their customers' respective assembly processes, while minimizing requirements for storage space, equipment setups/loading, and volume of material entering an industrial waste stream.

It is important that TI customers be familiar with available packing configurations. This application report summarizes descriptions of the packing configurations to make this information easier to disseminate.

Glossary

Carrier tape	Continuous, formed, embossed tape that is the primary container for components shipped in the tape-and-reel configuration
Cover tape	Clear or transparent tape applied to the carrier tape to seal the components in the individual tape compartments
Desiccant	Moisture-adsorbing material placed inside sealed dry-pack bags to adsorb internal bag moisture
Dry-pack bag	Moisture-barrier bag with water-vapor transmission rate (WVTR) less than 0.000365 gram per 100 square inches surface area per 24 hours
EIA	Electronics Industries Alliance
End pins	Pins inserted in holes near each end of a magazine to prevent the components from exiting the magazine
End plugs	Similar to end pins, but the plug is inserted in each open end of the magazine
Humidity-indicator card	Card that verifies that humidity levels in sealed dry-packed bags have not exceeded specified limits. The card changes color to indicate different humidity levels.
Intermediate container	Container(s) that are filled with loaded primary-level containers
JEDEC	Joint Electron Device Engineering Council
Magazine	Usually, extruded PVC shaped for individual component requirements to transport and store components. Also called stick magazine or shipping tube.
PDIP paper bag	Intermediate container used for most PDIP products
Primary container	Container used for the first level of packing
Reel	Industry-standard reel used to collect and feed the loaded and sealed carrier tape
Reel box (pizza box)	Intermediate container for the fully loaded reel, carrier tape, and cover tape
Termination	End of the package pins
Tray	Primary container used for QFP/TQFP/BGA devices, e.g., standard JEDEC outlines used as defined by package outlines
Tray box	Intermediate container for stacked and bound tray packs

Acknowledgment

The authors would like to thank Beverly Houghton for helping with the images and standard quantity tables and Randy Kirk for helping with the standard packing examples.

References

1. EIA-481 Standards – Excerpts used to assure complete alignment
2. EIA-783 – Component Orientation
3. JEDEC – *Moisture Sensitivity Testing Procedures: EIA/JEDEC A112-A, EIA/JEDEC A113-B*

IMPORTANT NOTICE

Texas Instruments Incorporated and its subsidiaries (TI) reserve the right to make corrections, modifications, enhancements, improvements, and other changes to its products and services at any time and to discontinue any product or service without notice. Customers should obtain the latest relevant information before placing orders and should verify that such information is current and complete. All products are sold subject to TI's terms and conditions of sale supplied at the time of order acknowledgment.

TI warrants performance of its hardware products to the specifications applicable at the time of sale in accordance with TI's standard warranty. Testing and other quality control techniques are used to the extent TI deems necessary to support this warranty. Except where mandated by government requirements, testing of all parameters of each product is not necessarily performed.

TI assumes no liability for applications assistance or customer product design. Customers are responsible for their products and applications using TI components. To minimize the risks associated with customer products and applications, customers should provide adequate design and operating safeguards.

TI does not warrant or represent that any license, either express or implied, is granted under any TI patent right, copyright, mask work right, or other TI intellectual property right relating to any combination, machine, or process in which TI products or services are used. Information published by TI regarding third-party products or services does not constitute a license from TI to use such products or services or a warranty or endorsement thereof. Use of such information may require a license from a third party under the patents or other intellectual property of the third party, or a license from TI under the patents or other intellectual property of TI.

Reproduction of information in TI data books or data sheets is permissible only if reproduction is without alteration and is accompanied by all associated warranties, conditions, limitations, and notices. Reproduction of this information with alteration is an unfair and deceptive business practice. TI is not responsible or liable for such altered documentation.

Resale of TI products or services with statements different from or beyond the parameters stated by TI for that product or service voids all express and any implied warranties for the associated TI product or service and is an unfair and deceptive business practice. TI is not responsible or liable for any such statements.

Following are URLs where you can obtain information on other Texas Instruments products and application solutions:

Products		Applications	
Amplifiers	amplifier.ti.com	Audio	www.ti.com/audio
Data Converters	dataconverter.ti.com	Automotive	www.ti.com/automotive
DSP	dsp.ti.com	Broadband	www.ti.com/broadband
Interface	interface.ti.com	Digital Control	www.ti.com/digitalcontrol
Logic	logic.ti.com	Military	www.ti.com/military
Power Mgmt	power.ti.com	Optical Networking	www.ti.com/opticalnetwork
Microcontrollers	microcontroller.ti.com	Security	www.ti.com/security
		Telephony	www.ti.com/telephony
		Video & Imaging	www.ti.com/video
		Wireless	www.ti.com/wireless

Mailing Address: Texas Instruments
Post Office Box 655303 Dallas, Texas 75265