

Application Note

AFE79XX as a Chirp Signal Generator



Nikhil Jain and Dhruvil Solanki

ABSTRACT

This application note describes the usage of AFE79XX family of devices as chirp frequency generators. The AFE79XX is a family of high-performance, wide-bandwidth multi-channel transceivers, integrating four RF sampling transmitter chains, four RF sampling receiver chains, and up to two RF sampling digitizing auxiliary chains (feedback paths). Each receiver chain includes a 25dB range DSA (Digital Step Attenuator), followed by a 3GSPS analog-to-digital converter (ADC). Each transmitter chain includes a single or dual digital up converters (DUCs) supporting up to 1200MHz combined signal bandwidth. The output of the DUCs drives a 12-GSPS digital-to-analog converter (DAC). The feedback path includes a 25dB range DSA driving a 3GSPS RF-sampling ADC, followed by a DDC with up to 1200MHz bandwidth. The AFE79xx's improvement in density and flexibility enables high-channel-count, multi-mission systems, and makes these devices a very attractive option for wideband linear chirp frequency applications.

Table of Contents

1 Introduction	2
2 AFE79XX TX Architecture	3
3 Numerically Controlled Oscillator	3
4 Configuring the AFE79XX for Multi-Band Jamming	4
4.1 Overview of Configurability.....	4
4.2 Jamming Related Latte Functions and Parameters.....	4
4.3 Results.....	5
5 Summary	8
6 References	8

Trademarks

All trademarks are the property of their respective owners.

1 Introduction

A **chirp** is a signal in which the frequency increases (*up-chirp*) or decreases (*down-chirp*) with time. In some sources, the term *chirp* is used interchangeably with **sweep signal**. Chirp is commonly applied to sonar, radar, and laser systems, and to other applications, such as in spread spectrum communications. A linear chirp waveform is also referred to as Linear Frequency Modulation (LFM) Waveform.

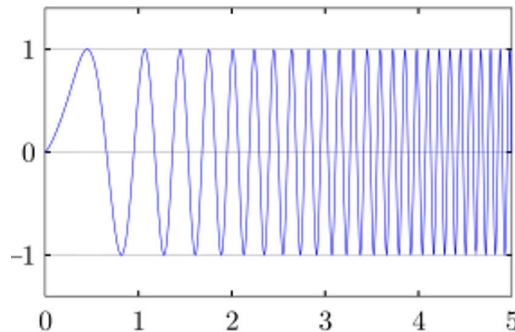

Figure 1-1. A Linear Chirp Waveform (A Sinusoidal Waveform that Increases in Frequency Linearly in Time)

One popular application of this is Linear frequency modulation (LFM) based jamming, also known as chirp jamming, is a technique used to disrupt communication systems that rely on linear frequency modulation for transmission. In LFM-based jamming, the jammer emits a signal that continuously varies in frequency over time according to a linear function. This results in a signal with a continuously changing frequency, resembling a *chirp* in the frequency domain. When the jammer's chirp signal overlaps with the frequency range used by the target communication system, it interferes with the reception of the legitimate signal. This interference can disrupt the communication link, causing errors in data transmission, loss of synchronization, or complete loss of communication. LFM-based jamming is effective against communication systems that are not designed to handle or mitigate frequency-modulated interference. However, some modern communication systems employ techniques such as frequency agile modulation or advanced signal processing to mitigate the effects of LFM-based jamming.

Figure 1-2 shows an example of stepped LFM frequency versus time profile.

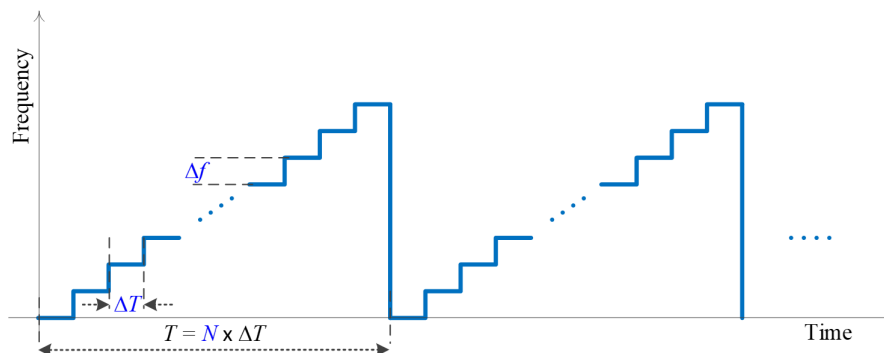

Figure 1-2. LFM Frequency versus Time Profile

Here,

Δf is the frequency step

Δt is the dwell time, that is, the time for which one of the frequencies is transmitted.

$T = N \times \Delta T$ is the total sweep time.

2 AFE79XX TX Architecture

The AFE79XX integrates 4 transmitters based on RF sampling DACs. Figure 2-1 shows the TX chain block diagram for a single DUC. The DAC output can operate at up to 12GSPS and is followed by a TX DSA (Digital Step Attenuator). The digital section of the TX includes dual or single DUCs to increase the input sample rate to the DAC sample rate. The digital block also includes gain control and a PA protection block.

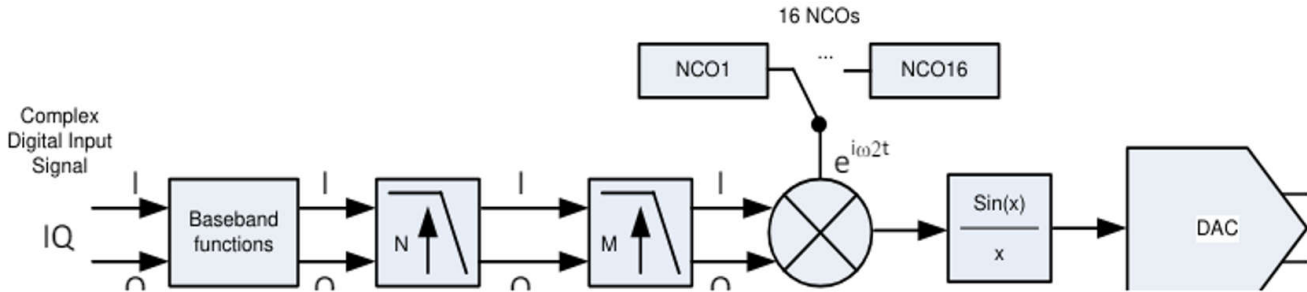

Figure 2-1. TX Chain Block Diagram with Single DUC

3 Numerically Controlled Oscillator

The complex digital mixers in the AFE79XX DDC and DUC include digital quadrature modulator (DQM) blocks with independent Numerically Controlled Oscillator (NCO) or NCOs. The NCOs convert the complex input signal to a real output signal with flexible frequency placement between 0 and $f_{DAC} / 2$, where f_{DAC} is the DAC sampling clock frequency. The NCOs have a 32-bit frequency accumulator value that generates the sine and cosine terms for the complex mixing. Figure 3-1 shows the NCO block diagram.

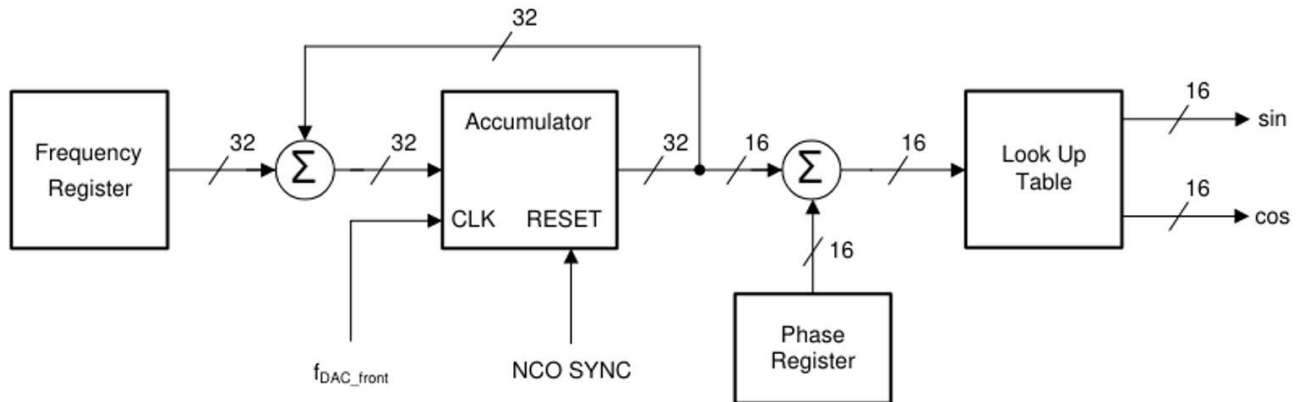

Figure 3-1. NCO Block Diagram

4 Configuring the AFE79XX for Multi-Band Jamming

4.1 Overview of Configurability

AFE79XX has four TX channels, configurable to independently operate in different frequency bands across their supported output frequencies that is, 600MHz to 12 GHz for AFE7950 and from 5MHz to 7.4GHz for AFE7900. RF sampling architecture employing digital mixers or NCOs provides high configurability. Multi-band jamming can be enabled using a single device by configuring all four Tx channels to sweep frequencies with independent band and bandwidth.

Each transmitter chain has 16 NCO running in parallel whose frequencies can be continuously updated by the device in chirp generator mode in the steps defined by user. In the chirp mode, the device is configured to give constant input to the mixer. This DC signal is up converted by the digital mixer as per the NCO value which is then transmitted from the TX chain through the DAC output.

The dwell time that is, time spent at one of the step frequencies achieved by the device is around 750ns (Minimum Dwell Time).

4.2 Jamming Related Latte Functions and Parameters

Configuring the device in this mode is very simple and can be done by following these steps:

1. Install Latte Version 2.4.0 or later from TI's *My Secure Resources*.
2. While doing the device bringup, set the following parameters with these values in the bringup script:

```
sysParams.ncoFreqMode      = "FCW"
sysParams.autoFcwConvert   = 1
sysParams.txChainDirectCtrl = 1
```

3. Call the function AFE.txNcoSweep()

AFE.txNcoSweep(en, freqStart1, span1, freqStart2, span2, freqStart3, span3, freqStart4, span4, steps)

With designed for input arguments where:

En= 1 enables jammer mode and 0 brings back the device into default working mode.

freqStart1(MHz)= Start Frequency for Tx channel 1.

$$LSB = \frac{F_{dac} \text{ GHz}}{2^{32}} \quad (1)$$

span1(MHz)=Bandwidth for Tx channel 1.

freqStart2(MHz)= Start Frequency for Tx channel 2.

$$LSB = \frac{F_{dac} \text{ GHz}}{2^{32}} \quad (2)$$

span2(MHz)=Bandwidth for Tx channel 2.

freqStart3(MHz)= Start Frequency for Tx channel 3.

$$LSB = \frac{F_{dac} \text{ GHz}}{2^{32}} \quad (3)$$

span3(MHz)=Bandwidth for Tx channel 3.

freqStart4(MHz)= Start Frequency for Tx channel 4.

$$LSB = \frac{F_{dac} \text{ GHz}}{2^{32}} \quad (4)$$

span4(MHz)=Bandwidth for Tx channel 4.

Steps = Number of frequency steps in which all the Tx channels can sweep across the designated bandwidths.

The application of the above function is shown with the below example where the AFE7900's 3 channels are configured to jam three different bands and mentioned:

- TX1 is configured to transmit in the 2.4GHz band with BW 85MHz.
- TX2 is configured to transmit in the 0.9GHz band with BW 28MHz.
- TX3 is configured to transmit in the 5GHz band with BW 125MHz.

AFE. txNcoSweep (1,2400,85,900,28,5000,125,2400,85,87)

Here the last argument that is, the number of frequency steps is given as 87.

4.3 Results

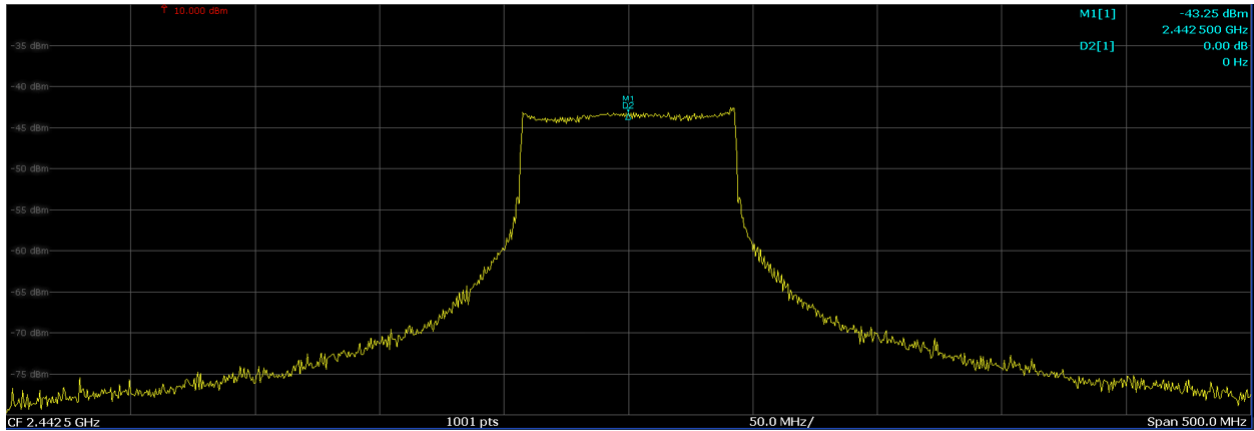

Figure 4-1. Spectrum Analyzer in Max Hold Mode (85MHz Sweep at ≈2.4GHz, in ≈62μs)

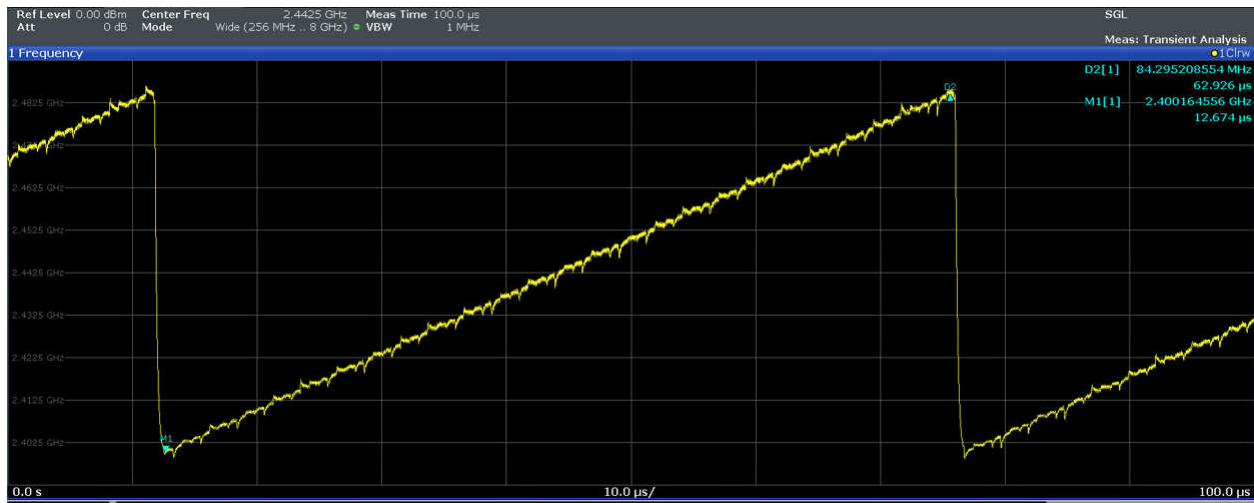

Figure 4-2. Frequency versus Time from Phase Noise Analyzer (85MHz Sweep at ≈2.4GHz, in ≈62μs)

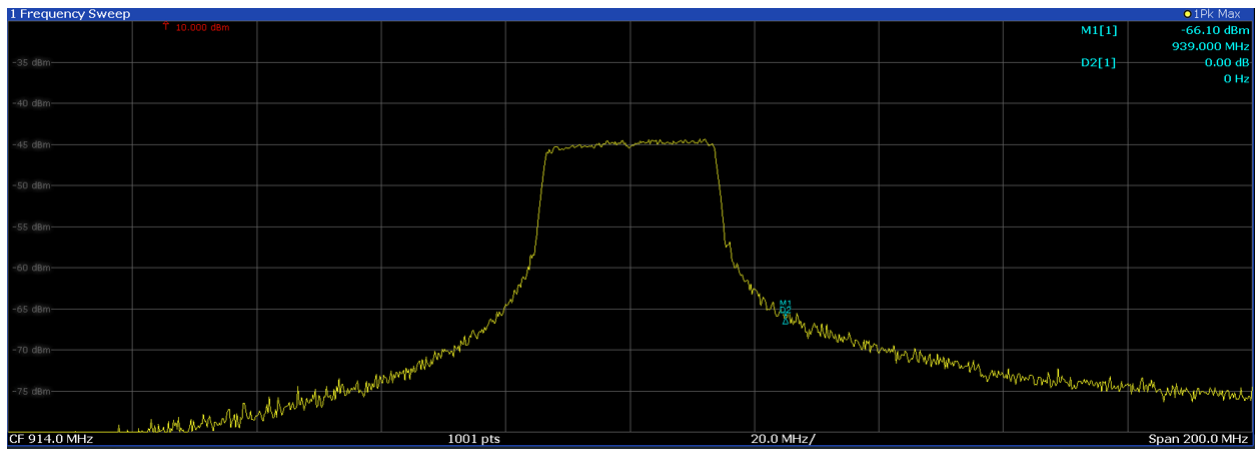

Figure 4-3. Spectrum Analyzer in Max Hold Mode (28MHz Sweep at ≈ 0.9 GHz, in $\approx 62\mu$ s)

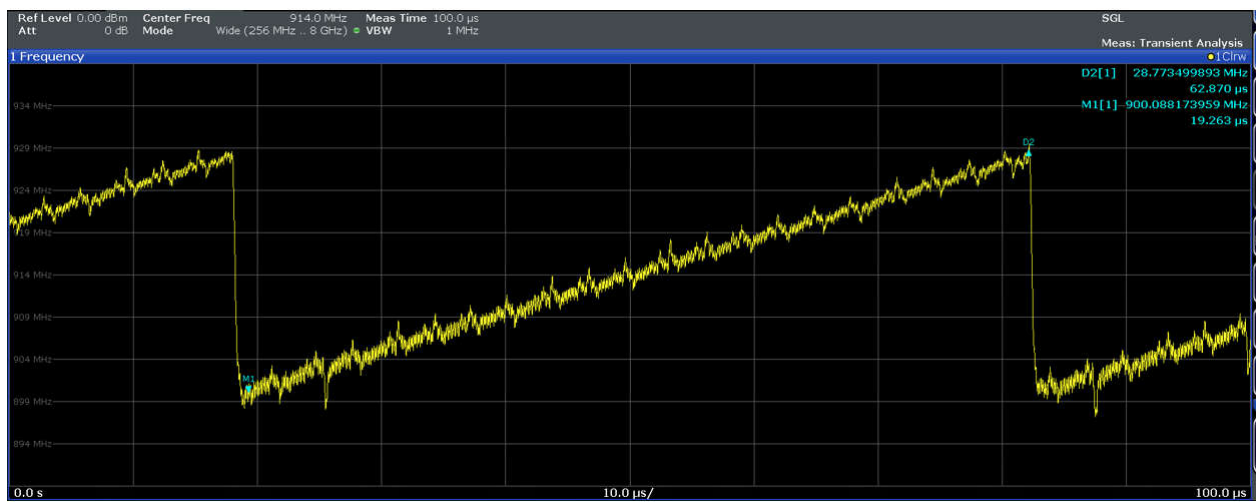

Figure 4-4. Frequency versus Time from Phase Noise Analyzer (28MHz Sweep at ≈ 0.9 GHz, in $\approx 62\mu$ s)

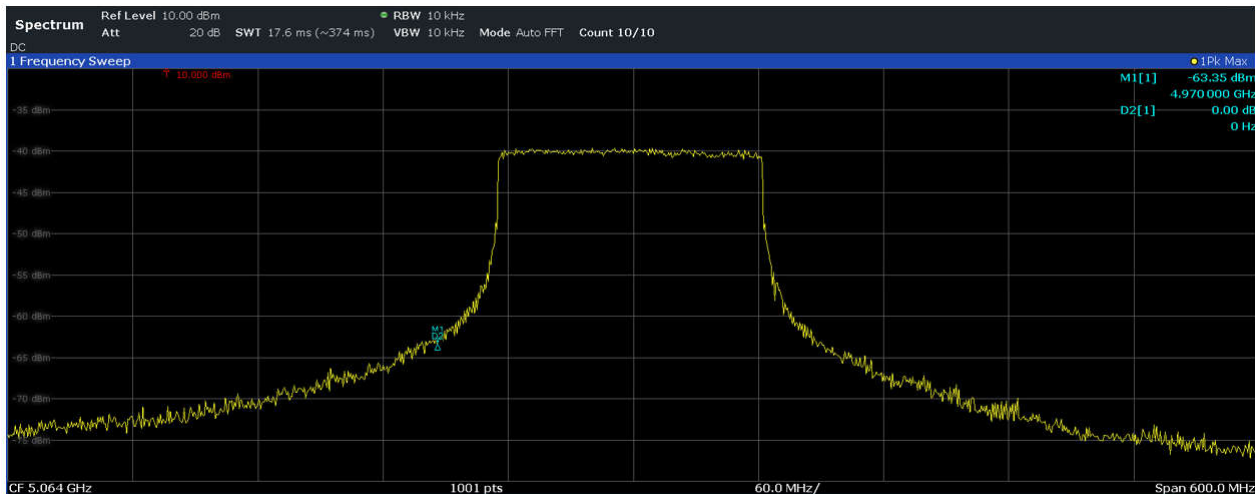

Figure 4-5. Spectrum Analyzer in Max Hold Mode (125MHz Sweep at ≈ 5 GHz, in $\approx 62\mu$ s)

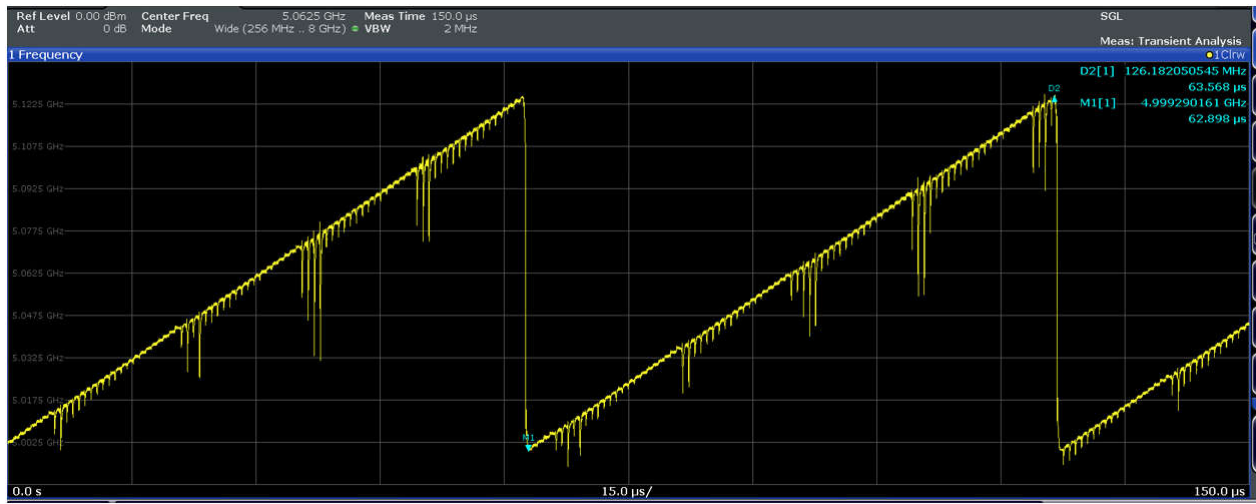

Figure 4-6. Frequency versus Time from Phase Noise Analyzer (125MHz Sweep at \approx 5GHz, in \approx 62 μ s)

5 Summary

This application note describes the procedure to use AFE79XX as Linear Frequency Modulated Signal generator which can be used as multi band Jammer with a single device by configuring all four Tx channels to sweep frequencies with independent band and bandwidth.

The dwell time, that is, time spent at one of the step frequencies achieved by the device is around 750ns (Minimum Dwell Time).

6 References

- MathWorld--A Wolfram Web Resource, [Sweep Signal](#), Weisstein, Eric W.
- IEEE Sensors Journal, 16 (15): 5912–5920, [A Simplified Technique for Distance and Velocity Measurements of Multiple Moving Objects Using a Linear Frequency Modulated Signal](#), , Lee, Tae-Yun; Jeon, Se-Yeon; Han, Junghwan; Skvortsov, Vladimir; Nikitin, Konstantin; Ka, Min-Ho (2016).
- [Bibcode](#).
- [2016ISenJ..16.5912L](#).
- [doi](#).
- [10.1109/JSEN.2016.2563458](#).
- [S2CID](#).
- [Semantic Scholar Identifier](#).
- [41233620](#) .

IMPORTANT NOTICE AND DISCLAIMER

TI PROVIDES TECHNICAL AND RELIABILITY DATA (INCLUDING DATA SHEETS), DESIGN RESOURCES (INCLUDING REFERENCE DESIGNS), APPLICATION OR OTHER DESIGN ADVICE, WEB TOOLS, SAFETY INFORMATION, AND OTHER RESOURCES "AS IS" AND WITH ALL FAULTS, AND DISCLAIMS ALL WARRANTIES, EXPRESS AND IMPLIED, INCLUDING WITHOUT LIMITATION ANY IMPLIED WARRANTIES OF MERCHANTABILITY, FITNESS FOR A PARTICULAR PURPOSE OR NON-INFRINGEMENT OF THIRD PARTY INTELLECTUAL PROPERTY RIGHTS.

These resources are intended for skilled developers designing with TI products. You are solely responsible for (1) selecting the appropriate TI products for your application, (2) designing, validating and testing your application, and (3) ensuring your application meets applicable standards, and any other safety, security, regulatory or other requirements.

These resources are subject to change without notice. TI grants you permission to use these resources only for development of an application that uses the TI products described in the resource. Other reproduction and display of these resources is prohibited. No license is granted to any other TI intellectual property right or to any third party intellectual property right. TI disclaims responsibility for, and you will fully indemnify TI and its representatives against, any claims, damages, costs, losses, and liabilities arising out of your use of these resources.

TI's products are provided subject to [TI's Terms of Sale](#) or other applicable terms available either on [ti.com](https://www.ti.com) or provided in conjunction with such TI products. TI's provision of these resources does not expand or otherwise alter TI's applicable warranties or warranty disclaimers for TI products.

TI objects to and rejects any additional or different terms you may have proposed.

Mailing Address: Texas Instruments, Post Office Box 655303, Dallas, Texas 75265
Copyright © 2024, Texas Instruments Incorporated