

TLE2071 EMI Immunity Performance

1 EMI Rejection Ratio (EMIRR)

The electromagnetic interference (EMI) rejection ratio, or EMIRR, describes the EMI immunity of operational amplifiers. An adverse effect that is common to many op amps is a change in the offset voltage as a result of RF signal rectification. An op amp that is more efficient at rejecting this change in offset as a result of EMI has a higher EMIRR and is quantified by a decibel value.

Measuring EMIRR can be performed in many ways, but this report provides the EMIRR IN+, which specifically describes the EMIRR performance when the RF signal is applied to the noninverting input pin of the op amp. In general, only the noninverting input is tested for EMIRR for the following three reasons:

1. Op amp input pins are known to be the most sensitive to EMI, and typically rectify RF signals better than the supply or output pins.
2. The noninverting and inverting op amp inputs have symmetrical physical layouts and exhibit nearly matching EMIRR performance.
3. EMIRR is easier to measure on noninverting pins than on other pins because the noninverting input terminal can be isolated on a printed circuit board (PCB). This isolation allows the RF signal to be applied directly to the noninverting input terminal with no complex interactions from other components or connecting PCB traces.

A more formal discussion of the EMIRR IN+ definition and test method is provided in application report [SBOA128, EMI Rejection Ratio of Operational Amplifiers](#), available for download at www.ti.com.

The EMIRR IN+ of the TLE2071 is plotted versus frequency as shown in [Figure 1](#). If available, any dual and quad op amp device versions have nearly similar EMIRR IN+ performance. The TLE2071 unity-gain bandwidth is 9.4 MHz. EMIRR performance below this frequency denotes interfering signals that fall within the op amp bandwidth.

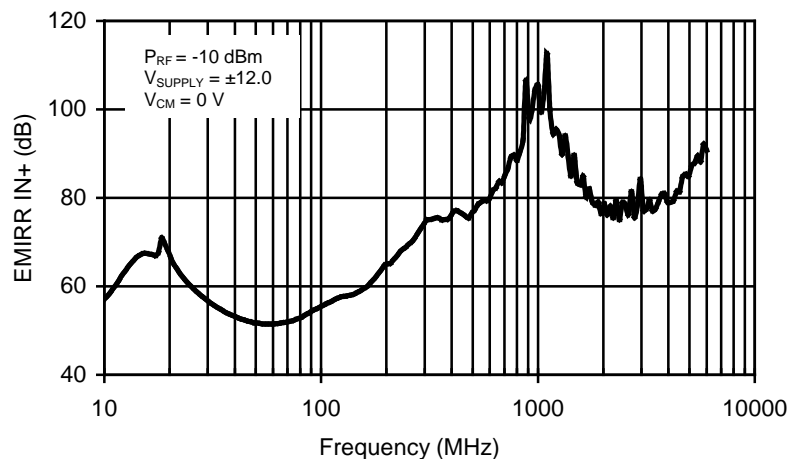

Figure 1. TLE2071 EMIRR IN+ vs Frequency

Bluetooth is a registered trademark of Bluetooth SIG, Inc. All other trademarks are property of their respective owners.

Table 1 shows the EMIRR IN+ values for the TLE2071 at particular frequencies commonly encountered in real-world applications. Applications listed in Table 1 may be centered on or operated near the particular frequency shown. This information may be of special interest to designers working with these types of applications, or working in other fields likely to encounter RF interference from broad sources, such as the industrial, scientific, and medical (ISM) radio band.

Table 1. TLE2071 EMIRR IN+ for Frequencies of Interest

FREQUENCY	APPLICATION/ALLOCATION	EMIRR IN+
400 MHz	Mobile radio, mobile satellite/space operation, weather, radar, UHF	75.9 dB
900 MHz	GSM, radio com/nav./GPS (to 1.6 GHz), ISM, aeronautical mobile, UHF	97.9 dB
1.8 GHz	GSM, mobile personal comm. broadband, satellite, L-band	79.1 dB
2.4 GHz	802.11b/g/n, Bluetooth™, mobile personal comm., ISM, amateur radio/satellite, S-band	75.1 dB
3.6 GHz	Radiolocation, aero comm./nav., satellite, mobile, S-band	79.0 dB
5.0 GHz	802.11a/n, aero comm./nav., mobile comm., space/satellite operation, C-band	84.8 dB

2 EMIRR IN+ Test Configuration

Figure 2 shows the circuit configuration for testing the EMIRR IN+. An RF source is connected to the op amp noninverting input terminal using a transmission line. The op amp is configured in a unity gain buffer topology with the output connected to a low-pass filter (LPF) and a digital multimeter (DMM). Note that a large impedance mismatch at the op amp input causes a voltage reflection; however, this effect is characterized and accounted for when determining the EMIRR IN+. The resulting dc offset voltage is sampled and measured by the multimeter. The LPF isolates the multimeter from residual RF signals that may interfere with multimeter accuracy. Refer to [SBOA128](#) for more details.

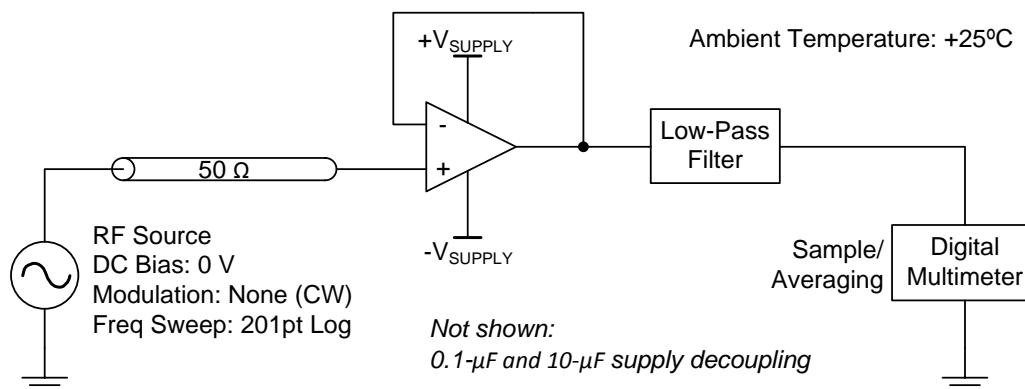

Figure 2. EMIRR IN+ Test Configuration Schematic

References

1. Chris Hall and Thomas Kuehl, “[EMI Rejection Ratio of Operational Amplifiers](#),” application report [SBOA128](#), Texas Instruments, August 2011.
2. Gerrit de Wagt and Arie van Staveren, “[A Specification for EMI Hardened Operational Amplifiers](#),” application report [SNOA497A](#), Texas Instruments, January 2010.

IMPORTANT NOTICE

Texas Instruments Incorporated and its subsidiaries (TI) reserve the right to make corrections, enhancements, improvements and other changes to its semiconductor products and services per JESD46, latest issue, and to discontinue any product or service per JESD48, latest issue. Buyers should obtain the latest relevant information before placing orders and should verify that such information is current and complete. All semiconductor products (also referred to herein as "components") are sold subject to TI's terms and conditions of sale supplied at the time of order acknowledgment.

TI warrants performance of its components to the specifications applicable at the time of sale, in accordance with the warranty in TI's terms and conditions of sale of semiconductor products. Testing and other quality control techniques are used to the extent TI deems necessary to support this warranty. Except where mandated by applicable law, testing of all parameters of each component is not necessarily performed.

TI assumes no liability for applications assistance or the design of Buyers' products. Buyers are responsible for their products and applications using TI components. To minimize the risks associated with Buyers' products and applications, Buyers should provide adequate design and operating safeguards.

TI does not warrant or represent that any license, either express or implied, is granted under any patent right, copyright, mask work right, or other intellectual property right relating to any combination, machine, or process in which TI components or services are used. Information published by TI regarding third-party products or services does not constitute a license to use such products or services or a warranty or endorsement thereof. Use of such information may require a license from a third party under the patents or other intellectual property of the third party, or a license from TI under the patents or other intellectual property of TI.

Reproduction of significant portions of TI information in TI data books or data sheets is permissible only if reproduction is without alteration and is accompanied by all associated warranties, conditions, limitations, and notices. TI is not responsible or liable for such altered documentation. Information of third parties may be subject to additional restrictions.

Resale of TI components or services with statements different from or beyond the parameters stated by TI for that component or service voids all express and any implied warranties for the associated TI component or service and is an unfair and deceptive business practice. TI is not responsible or liable for any such statements.

Buyer acknowledges and agrees that it is solely responsible for compliance with all legal, regulatory and safety-related requirements concerning its products, and any use of TI components in its applications, notwithstanding any applications-related information or support that may be provided by TI. Buyer represents and agrees that it has all the necessary expertise to create and implement safeguards which anticipate dangerous consequences of failures, monitor failures and their consequences, lessen the likelihood of failures that might cause harm and take appropriate remedial actions. Buyer will fully indemnify TI and its representatives against any damages arising out of the use of any TI components in safety-critical applications.

In some cases, TI components may be promoted specifically to facilitate safety-related applications. With such components, TI's goal is to help enable customers to design and create their own end-product solutions that meet applicable functional safety standards and requirements. Nonetheless, such components are subject to these terms.

No TI components are authorized for use in FDA Class III (or similar life-critical medical equipment) unless authorized officers of the parties have executed a special agreement specifically governing such use.

Only those TI components which TI has specifically designated as military grade or "enhanced plastic" are designed and intended for use in military/aerospace applications or environments. Buyer acknowledges and agrees that any military or aerospace use of TI components which have **not** been so designated is solely at the Buyer's risk, and that Buyer is solely responsible for compliance with all legal and regulatory requirements in connection with such use.

TI has specifically designated certain components as meeting ISO/TS16949 requirements, mainly for automotive use. In any case of use of non-designated products, TI will not be responsible for any failure to meet ISO/TS16949.

Products

Audio	www.ti.com/audio
Amplifiers	amplifier.ti.com
Data Converters	dataconverter.ti.com
DLP® Products	www.dlp.com
DSP	dsp.ti.com
Clocks and Timers	www.ti.com/clocks
Interface	interface.ti.com
Logic	logic.ti.com
Power Mgmt	power.ti.com
Microcontrollers	microcontroller.ti.com
RFID	www.ti-rfid.com
OMAP Applications Processors	www.ti.com/omap
Wireless Connectivity	www.ti.com/wirelessconnectivity

Applications

Automotive and Transportation	www.ti.com/automotive
Communications and Telecom	www.ti.com/communications
Computers and Peripherals	www.ti.com/computers
Consumer Electronics	www.ti.com/consumer-apps
Energy and Lighting	www.ti.com/energy
Industrial	www.ti.com/industrial
Medical	www.ti.com/medical
Security	www.ti.com/security
Space, Avionics and Defense	www.ti.com/space-avionics-defense
Video and Imaging	www.ti.com/video

TI E2E Community

e2e.ti.com