



## ABSTRACT

This user's guide describes the characteristics, operation, and use of the LDC-HALL-HMI-EVM (Evaluation Module). Complete schematic diagrams, printed circuit board layouts, and bill of materials are included in this document.

---

## Table of Contents

<b>1 Overview</b> .....	2
1.1 EVM Kit List.....	2
1.2 Main EVM Elements.....	3
1.3 Operational Modes.....	4
<b>2 EVM GUI</b> .....	5
2.1 System Requirements.....	5
2.2 Installation.....	5
2.3 GUI Home Page.....	6
2.4 SCB Firmware.....	7
2.5 Data Plot.....	8
<b>3 Schematic</b> .....	9
<b>4 Layout</b> .....	10
<b>5 Bill of Materials</b> .....	12

## Trademarks

All trademarks are the property of their respective owners.

## 1 Overview

The LDC-HALL-HMI-EVM is the evaluation module version of the [TIDA-060039](#) reference design. This EVM utilizes the LDC3114 to implement inductive touch buttons and the TMAG5273 to implement contactless magnetic dial for a human machine interface (HMI). The EVM requires the [Sensor Control Board](#) (SCB) which connects to a host computer and controls the EVM operation. For more details on the design of this EVM, please see the [TIDA-060039 design guide](#).

### 1.1 EVM Kit List

[Table 1-1](#) details the contents of the EVM kit. Note that the 3D printed housing and PCB are partially assembled while other components are provided in the box not assembled. Contact the nearest Texas Instruments Product Information Center if any components are missing.

**Table 1-1. EVM Kit Contents**

Item	Quantity	Note
LDC-HALL-HMI-EVM	1	Pre-assembled
Micro-USB Cable	1	Included in kit
3D Printed Housing Base	1	Pre-assembled
3D Printed Housing Button Surface	1	Pre-assembled
3D Printed Dial	1	Pre-assembled
3D printed Housing Top Cover	1	Included in kit
Metal Spring	1	Pre-assembled
1/4" dia. x 1/8" thick, N42 diametric magnet	1	Pre-assembled

## 1.2 Main EVM Elements

The LDC-HALL-HMI-EVM is designed to showcase inductive touch buttons and magnetic Hall dial in an HMI application. The inductive touch buttons are implemented using two LDC3114 devices while the TMAG5273 is used for the magnetic dial.

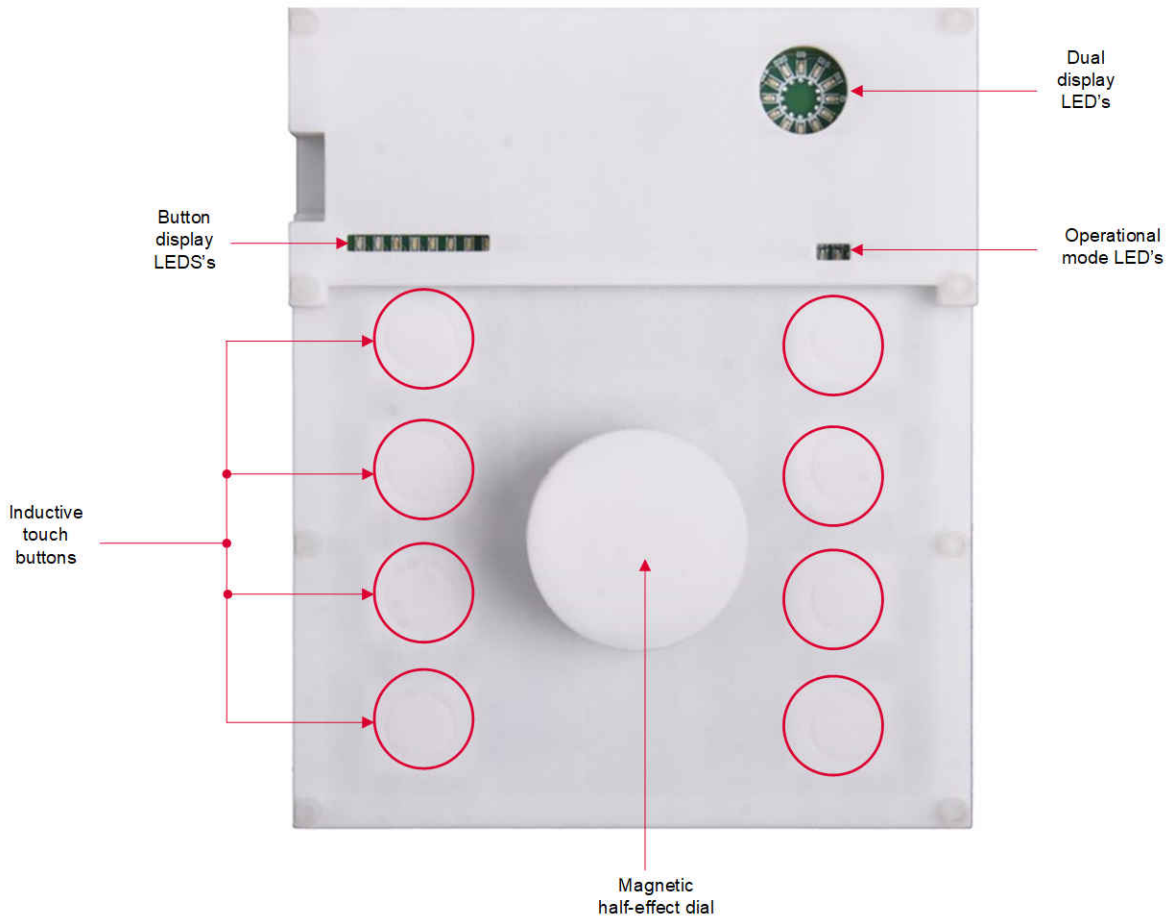

**Figure 1-1. EVM Features**

The EVM requires the SCB in order to operate. The SCB can be plugged into the provided headers on the EVM PCB and rested inside the 3D printed housing. The top portion of the housing can then be installed and bolted shut with the provided nylon bolts and nuts.

## 1.3 Operational Modes

The LDC-HALL-HMI-EVM has different operational modes that can be changed by pushing in on the magnetic dial in the center of the EVM. In all operational modes, the magnetic dial keeps the same functionality. The angle of the dial is split into twelve segments and reported on the circular ring of LEDs at the top right of the board. Pushing in on the dial signals the EVM to switch to the next operational mode. The only change between the operational modes is how the inductive touch button data is handled.

### 1.3.1 Operational Mode 1

In the first operational mode, the LDC3114 baseline tracking algorithm is enabled and the digital outputs from the two ICs are tied to the button LEDs. Each touch button will correlate to one of the LEDs. Each LDC3114 also uses the MAXWIN feature of the baseline tracking algorithm in this mode. This feature only allows one of the inductive touch buttons on each side of the EVM to report data to the digital outputs at a time.

### 1.3.2 Operational Mode 2

The second operational mode keeps the LDC3114's baseline tracking algorithm enabled, but looks at each channels data instead of the digital output. All eight of the button channels can report data to the main MCU through the I2C. From there, the buttons can report the maximum response through the button LEDs. With a higher response in data, more LEDs will light up. If a force on a button surface continues to increase after all LEDs have been turned on, the maximum force will be recorded and used as a new baseline to compare against when illuminating the LEDs. This will reset to the default value when the operational mode changes.

### 1.3.3 Operational Modes 3 and 4

Operational modes three and four are very similar and turn off the baseline tracking algorithm of the LDC3114s in order to access the raw data for each button. In operational mode three, the left set of buttons are monitored and reported to the EVM GUI. In operational mode four, the right side buttons are accessible by the EVM GUI.

## 2 EVM GUI

The LDC-HALL-HMI-GUI provides access to view the raw data response for the LDC3114 devices on the board.

### 2.1 System Requirements

The GUI software is compatible with Windows, Mac, and Linux operating systems. The online software works with Chrome, Firefox, and Safari browsers.

### 2.2 Installation

The GUI software for the LDC-HALL-HMI-EVM runs on TI's GUI Composer framework. The software is available as a live version that runs in a browser and as a download for offline use.

Download and install the PAMB Controller drivers from <https://www.ti.com/lit/zip/sbac253>. This is a one-time only setup.

Access the online version by navigating to <https://dev.ti.com/gallery/search/LDC-HALL-HMI-EVM>. To access the offline GUI, mouse over the *Download* icon, select your operating system from the list, then follow the installation instructions.

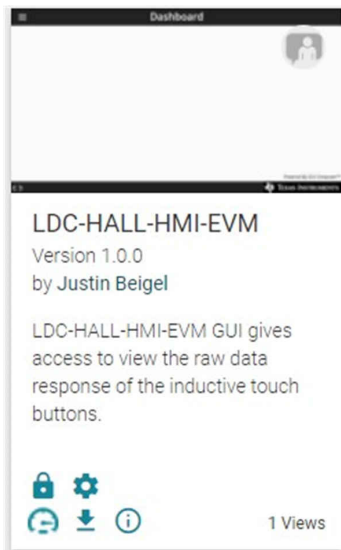

Figure 2-1. GUI Access Page

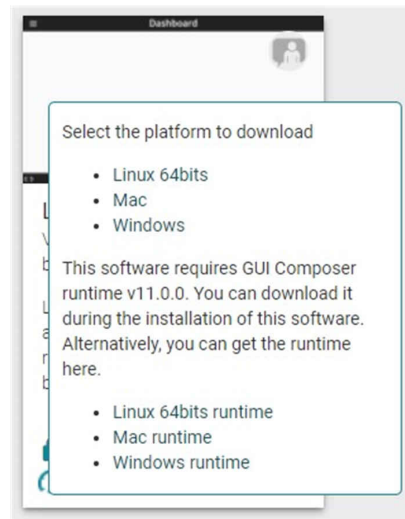

Figure 2-2. GUI Download Page

## 2.3 GUI Home Page

For first-time use, follow the prompts for TI Cloud Agent Installation:

### TI Cloud Agent Installation

Hardware interaction requires additional one time set up. Please perform the actions listed below and try your operation again.(What's this?)

- Step 1: **INSTALL** browser extension
- Step 2: **DOWNLOAD** and install the TI Cloud Agent Application
- Help. I already did this

**FINISH**

Figure 2-3. Initial GUI Setup

After the successful completion of the previous steps, the GUI is ready to use. When the EVM is put into one of the compatible modes (operational mode 3 or 4), the text in the bottom-left corner of the GUI should read *Hardware Connected*. If this is not the case, click the *Connect* button in the bottom left to manually tell the GUI to connect or go to *Options*→*Serial Port...* and select the correct port, then click *Ok*.

When the EVM is not connected, the home page of the GUI will show *Unknown* in the top-left corner.



Figure 2-4. GUI Unknown Device

The home page also has links at the bottom that show the connect to the block diagram, user's guide, and schematic for this EVM. Additionally, there is a link to our E2E forum if you have any questions about the design or devices.

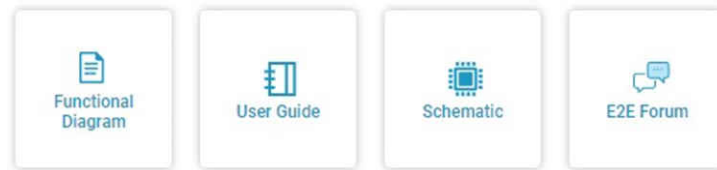

**Figure 2-5. GUI Links**

## 2.4 SCB Firmware

Firmware updates will be pushed through the GUI (requires previous driver to be installed). Downloaded offline GUIs will only update the SCB Controller with the latest firmware available at the time of download. To check for the latest GUI or Firmware updates, launch the latest GUI version from the web browser.

The first time a SCB is used with this EVM, it may need to be flashed with the proper firmware by going to *File* → *Program Device* in the GUI. In some cases, the SCB will be recognized by the GUI and can update to the proper firmware. If this is not the case, the SCB will need to be put into DFU mode by using the following steps:

If the firmware gets corrupted or must be manually reinstalled for any reason, follow these steps to reinstall the firmware.

1. Configure the MCU on the SCB to be in Device Firmware Update (DFU) Mode. DFU mode can be entered manually through one of the following methods while the SCB is powered on:
  - a. Through software:
    - Send the command "bsl" on the SCB's USB Serial (COM) port.
  - b. Through hardware (with the EVM removed):
    - Short the two test points labeled *DFU* (see [Figure 2-6](#)) with a pair of tweezers (or wire) while pressing the RESET button. If this is done correctly, LED D1 on the SCB should turn OFF while LED D5 (the power LED) is still ON. If LED D1 is still ON, the GUI firmware is still active and the device has not entered DFU mode.

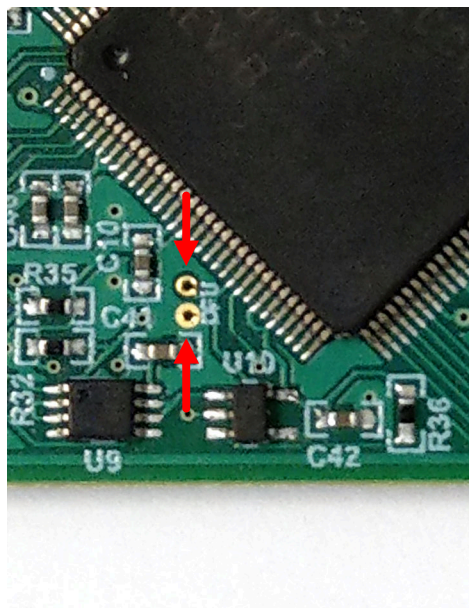
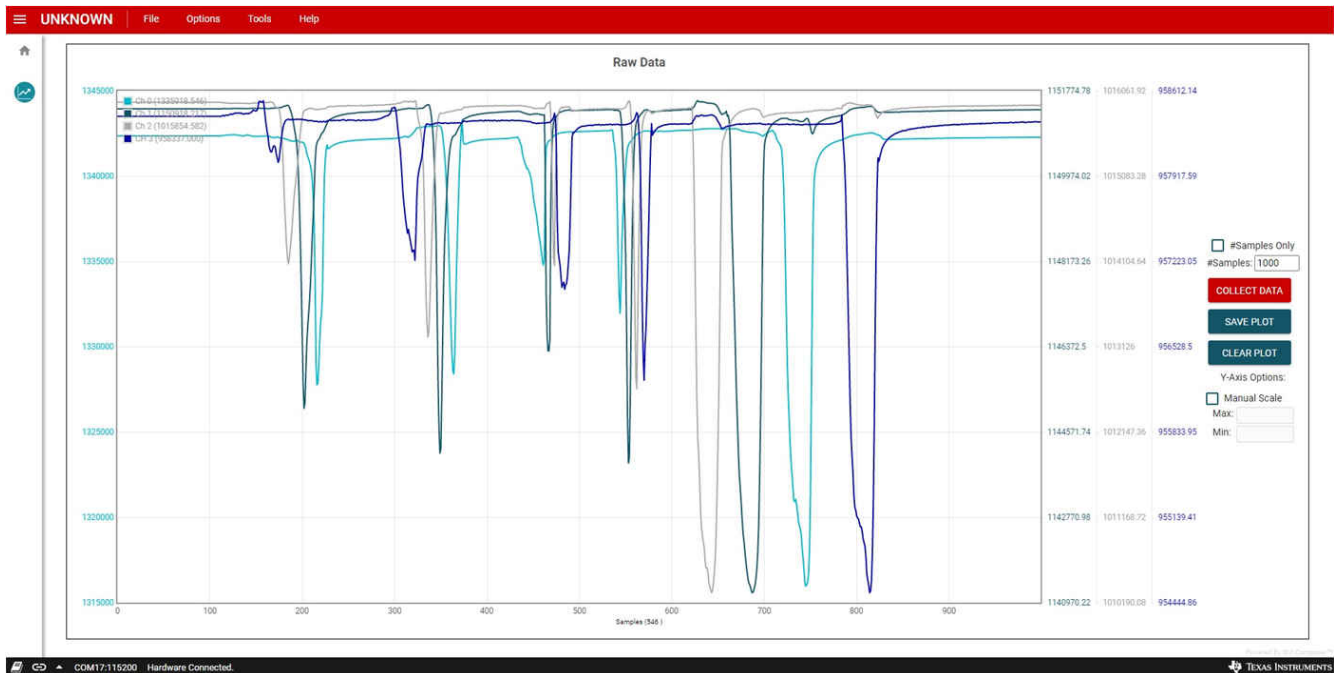

**Figure 2-6. Test Points Used to Enter DFU Mode Manually**

2. With the MCU in DFU mode, the GUI should recognize the SCB. After GUI recognition, go to *File* → *Program Device* to program the SCB.

## 2.5 Data Plot

Use the data plot page to view the raw data of the button presses after the EVM is in the proper mode. Click **COLLECT DATA** to start the EVM data collection. When data collection starts, the EVM ignores inputs on the magnetic dial and only processes the inductive touch buttons for the mode it is currently in (left side for mode 3 and right side for mode 4).



**Figure 2-7. GUI Data Page**

To stop the data collection, click **STOP COLLECT**. This will also resume the EVM's processing of the magnetic dial. When data is collected, the plot can be saved or cleared using the respective button. Lastly, the number of samples collected as well as the scale for the data can be changed for the data collection. The data plot will not clear when changing the operational mode so it should be manually cleared when switching from mode 3 to mode 4.



### 3 Schematic

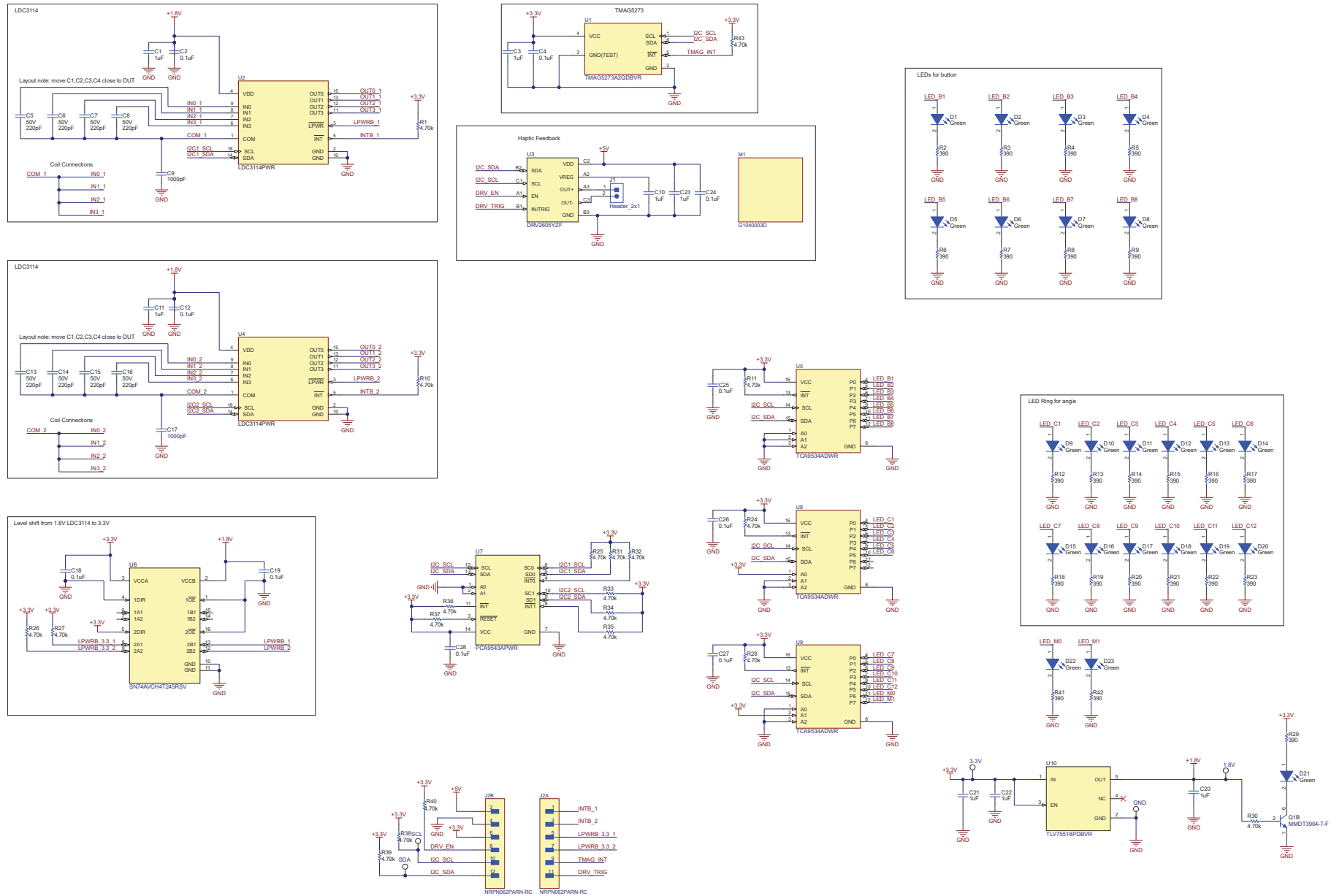

Figure 3-1. LDC-HALL-HMI-EVM Schematic

## 4 Layout

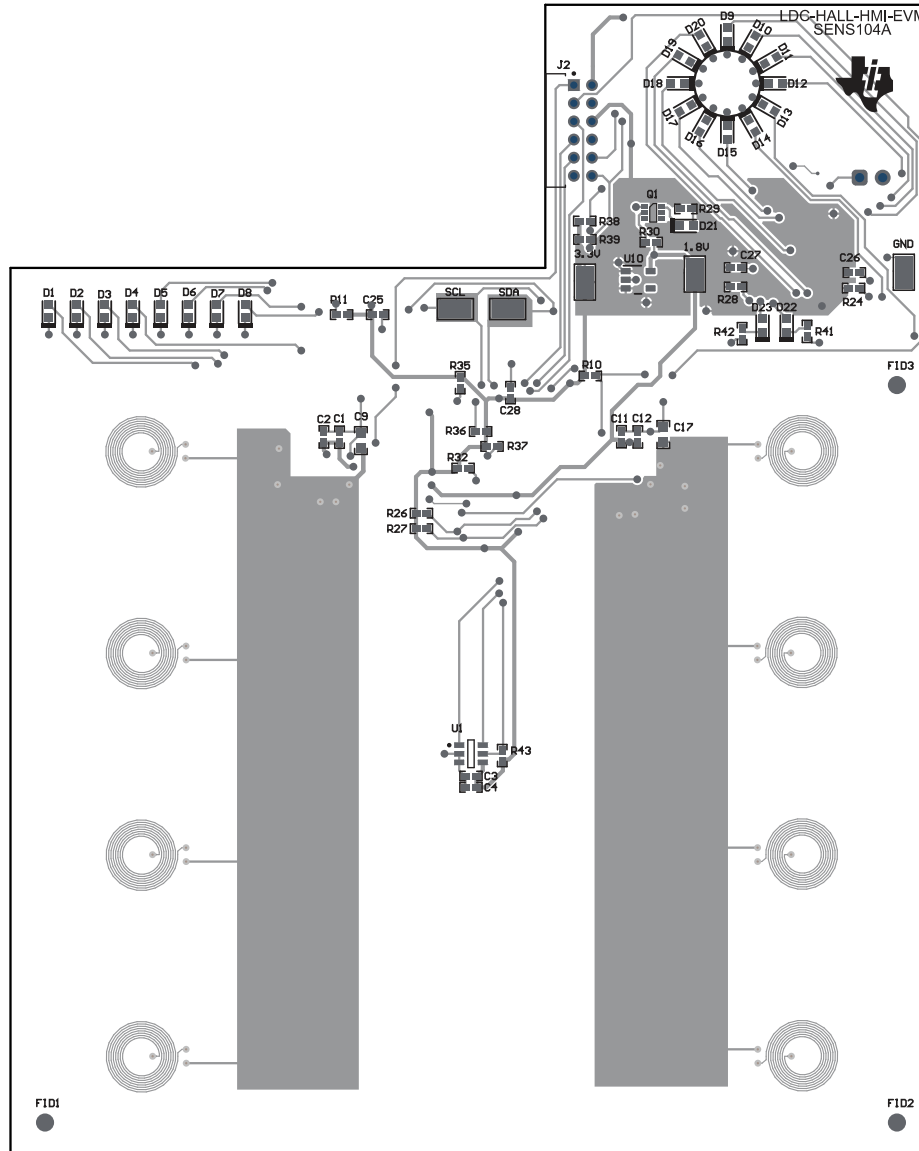
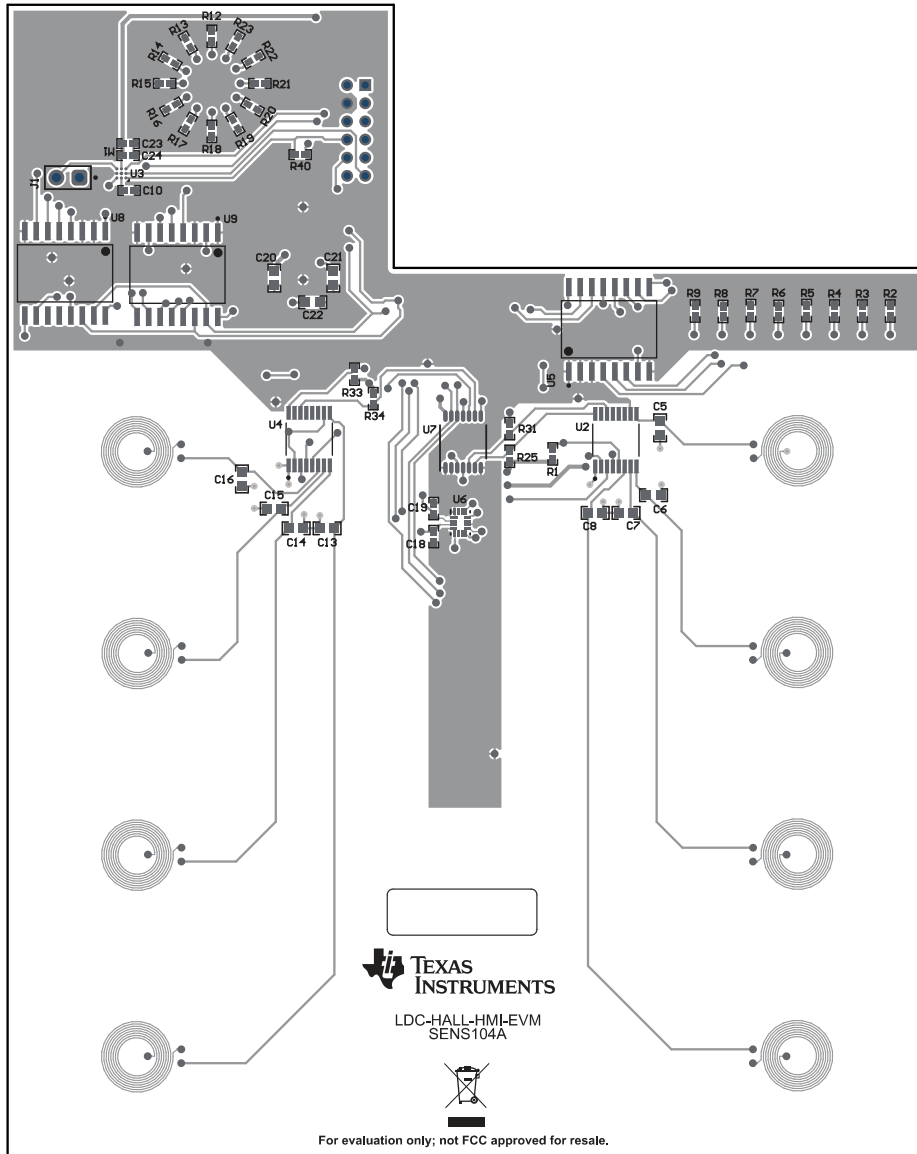

Figure 4-1. Top Layout



**Figure 4-2. Bottom Layout**

## 5 Bill of Materials

Item Number	Designator	Quantity	Value	Part Number	Manufacturer	Description	Package Reference
1	IPC B1	1		SENS104	Any	Printed Circuit Board	
2	C1, C3, C10, C11, C23	5	1uF	GRM155R70J105MA12D	MuRata	CAP, CERM, 1 uF, 6.3 V, +/- 20%, X7R, 0402	402
3	C2, C4, C12, C18, C19, C24, C25, C26, C27, C28	10	0.1uF	C1005X7R1H104K050BB	TDK	CAP, CERM, 0.1 uF, 50 V, +/- 10%, X7R, 0402	402
4	C5, C6, C7, C8, C13, C14, C15, C16	8	220pF	06035A221FAT2A	AVX	CAP, CERM, 220 pF, 50 V, +/- 1%, COG/NP0, 0603	603
5	C9, C17	2	1000pF	GRM1885C1H102FA01J	MuRata	CAP, CERM, 1000 pF, 50 V, +/- 1%, COG/NP0, 0603	603
6	C20, C21, C22	3	1uF	UMK107AB7105KA-T	Taiyo Yuden	CAP, CERM, 1 uF, 50 V, +/- 10%, X7R, 0603	603
7	D1, D2, D3, D4, D5, D6, D7, D8, D9, D10, D11, D12, D13, D14, D15, D16, D17, D18, D19, D20, D21, D22, D23	23	Green	LTST-C190GKT	Lite-On	LED, Green, SMD	1.6x0.8x0.8mm
8	FID1	1		N/A	N/A	Fiducial mark. There is nothing to buy or mount.	N/A
9	J2	1		NRPN062PARN-RC	Sullins Connector Solutions		HDR12
10	LBL1	1		THT-14-423-10	Brady	Thermal Transfer Printable Labels, 0.650" W x 0.200" H - 10,000 per roll	PCB Label 0.650 x 0.200 inch
11	M1	1		G1040003D	Jinlong Machinery & Electronics	VIBRATION MOTOR COIN LRA 170HZ	SOLDER_TAB_MOTOR
12	Q1	1	40 V	MMDT3904-7-F	Diodes Inc.	Transistor, Dual NPN, 40 V, 0.2 A, SOT-363	SOT-363

Item Number	Designator	Quantity	Value	Part Number	Manufacturer	Description	Package Reference
13	R1, R10, R11, R24, R25, R26, R27, R28, R30, R31, R32, R33, R34, R35, R36, R37, R38, R39, R40, R43	20	4.70k	ERJ-2RKF4701X	Panasonic	RES, 4.70 k, 1%, 0.1 W, 0402	402
14	R2, R3, R4, R5, R6, R7, R8, R9, R12, R13, R14, R15, R16, R17, R18, R19, R20, R21, R22, R23, R29, R41, R42	23	390	CRCW0402390RJNE D	Vishay-Dale	RES, 390, 5%, 0.063 W, AEC-Q200 Grade 0, 0402	402
15	U1	1		TMAG5273A2QDBVR	Texas Instruments	3-Axis Linear Hall Effect Sensor With I2C Interface SOT23-6	SOT23-6
16	U2, U4	2		LDC3114PWR	Texas Instruments	4-channel hybrid inductive touch and inductance to digital converter	TSSOP16
17	U3	1		DRV2605YZF	Texas Instruments	Haptic Driver for ERM and LRA with Built-In Library and Smart Loop Architecture, YZF0009ADAD (DSBGA-9)	YZF0009ADAD
18	U5, U8, U9	3		TCA9534ADWR	Texas Instruments	I/O Expander 8 I <sup>2</sup> C 400 kHz 16-SOIC	SOIC16
19	U6	1		SN74AVCH4T245RS VR	Texas Instruments	4-Bit Dual-Supply Bus Transceiver with Configurable Voltage Translation and 3-State Outputs, RSV0016A (UQFN-16)	RSV0016A

*Bill of Materials*

Item Number	Designator	Quantity	Value	Part Number	Manufacturer	Description	Package Reference
20	U7	1		PCA9543APWR	Texas Instruments	Two-Channel I2C-Bus Switch with Interrupt Logic and Reset, 2.3 to 5.5 V, -40 to 85 degC, 14-pin TSSOP (PW), Green (RoHS & no Sb/Br)	PW0014A
21	U10	1		TLV75518PDBVR	Texas Instruments	500-mA, Low IQ, Small Size, Low Dropout Regulator, DBV0005A (SOT-23-5)	DBV0005A
22	1.8V, 3.3V, GND, SCL, SDA	0		5015	Keystone	Test Point, Miniature, SMT	Testpoint_Keystone_Miniature
23	FID2, FID3	0		N/A	N/A	Fiducial mark. There is nothing to buy or mount.	N/A
24	J1	0		TSW-102-07-G-S	Samtec	Header, 100mil, 2x1, Gold, TH	2x1 Header

## IMPORTANT NOTICE AND DISCLAIMER

TI PROVIDES TECHNICAL AND RELIABILITY DATA (INCLUDING DATA SHEETS), DESIGN RESOURCES (INCLUDING REFERENCE DESIGNS), APPLICATION OR OTHER DESIGN ADVICE, WEB TOOLS, SAFETY INFORMATION, AND OTHER RESOURCES "AS IS" AND WITH ALL FAULTS, AND DISCLAIMS ALL WARRANTIES, EXPRESS AND IMPLIED, INCLUDING WITHOUT LIMITATION ANY IMPLIED WARRANTIES OF MERCHANTABILITY, FITNESS FOR A PARTICULAR PURPOSE OR NON-INFRINGEMENT OF THIRD PARTY INTELLECTUAL PROPERTY RIGHTS.

These resources are intended for skilled developers designing with TI products. You are solely responsible for (1) selecting the appropriate TI products for your application, (2) designing, validating and testing your application, and (3) ensuring your application meets applicable standards, and any other safety, security, regulatory or other requirements.

These resources are subject to change without notice. TI grants you permission to use these resources only for development of an application that uses the TI products described in the resource. Other reproduction and display of these resources is prohibited. No license is granted to any other TI intellectual property right or to any third party intellectual property right. TI disclaims responsibility for, and you will fully indemnify TI and its representatives against, any claims, damages, costs, losses, and liabilities arising out of your use of these resources.

TI's products are provided subject to [TI's Terms of Sale](#) or other applicable terms available either on [ti.com](http://ti.com) or provided in conjunction with such TI products. TI's provision of these resources does not expand or otherwise alter TI's applicable warranties or warranty disclaimers for TI products.

TI objects to and rejects any additional or different terms you may have proposed.

Mailing Address: Texas Instruments, Post Office Box 655303, Dallas, Texas 75265  
Copyright © 2022, Texas Instruments Incorporated