

Single-Supply, Low-Side, Unidirectional Current-Sensing Circuit with MSP430™ Smart Analog Combo



Design Goals

Input		Output		Supply		Full-Scale Range Error
I_{iMax}	V_{iMax}	V_{oMin}	V_{oMax}	V_{cc}	V_{ee}	FSR_{Error}
1 A	250 mV	100 mV	2.25 V	3.3 V	0 V	2.09%

Design Description

Some MSP430™ microcontrollers (MCUs) contain configurable integrated signal chain elements such as op-amps, DACs, and programmable gain stages. These elements make up a peripheral called the Smart Analog Combo (SAC). For information on the different types of SACs and how to leverage their configurable analog signal chain capabilities, visit [MSP430 MCUs Smart Analog Combo Training](#). To get started with your design, download the [Single-Supply, Low-Side, Unidirectional Current-Sensing Circuit Design Files](#).

This single-supply, low-side, current sensing solution accurately detects load current up to 1 A and converts it to a voltage between 100 mV and 2.25 V. The circuit uses the [MSP430FR2311](#) SAC_L1 op-amp in a noninverting amplifier configuration. There is room for further integration by using the programmable gain stage block within the [MSP430FR2355](#) SAC_L3 peripheral which allows you to integrate the feedback resistor ladder (R2 and R3) into the MCU. The input current range and output voltage range can be scaled as necessary and larger supplies can be used to accommodate larger swings. The output of the second stage op-amp can be sampled directly by the onboard ADC or monitored by the onboard comparator for further processing inside the MCU.

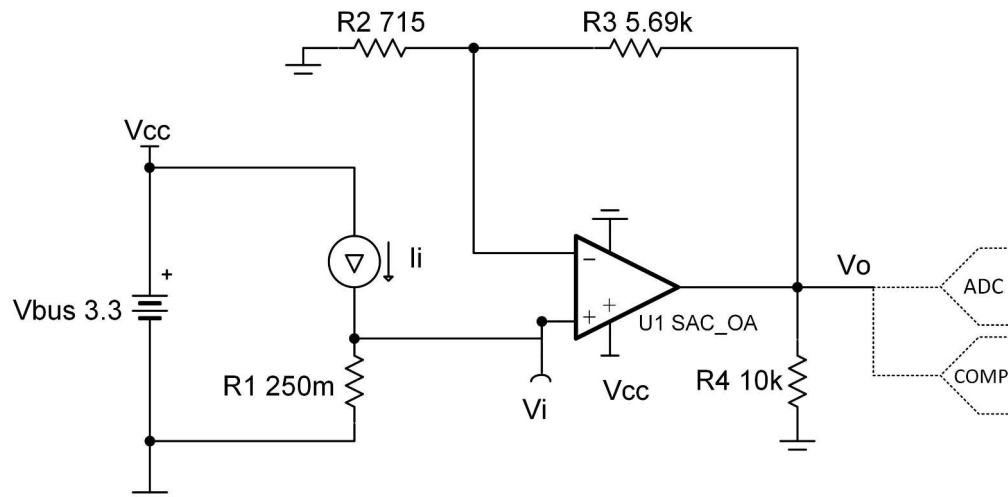

Design Notes

- Use the op amp linear output operating range, which is usually specified under the test conditions.
- The common-mode voltage is equal to the input voltage.
- The tolerance of the shunt resistor and feedback resistors determine the gain error of the circuit.
- Avoid placing capacitive loads directly on the output of the amplifier to minimize stability issues.
- Using high-value resistors can degrade the phase margin of the circuit and introduce additional noise in the circuit.
- The small-signal bandwidth of this circuit depends on the gain of the circuit and gain bandwidth product (GBP) of the amplifier.
- Filtering can be accomplished by adding a capacitor in parallel with R_3 . Adding a capacitor in parallel with R_3 also improves the stability of the circuit if high-value resistors are used.
- If the solution is implemented with the MSP430FR2355 SAC_L3, the op-amp can be configured in noninverting programmable gain amplifier mode or general-purpose mode with external R_2 and R_3 passives to measure the current-sense circuit.
- If the solution is implemented using the MSP430FR2311, the op-amp can be realized by the SAC_L1 op-amp or by the transimpedance amplifier (TIA) op-amp to measure the current-sense circuit.
- The enhanced reference module in the MSP430FR2355 can be used to scale the ADC using a VREF of 2.5 V to more accurately measure the output of the current sensing AFE.
- The [Single-Supply, Low-Side, Unidirectional Current-Sensing Circuit Design Files](#) include code examples showing how to properly initialize the SAC peripherals.

Design Steps

The transfer function for this circuit is given below.

$$V_o = I_i \times R_1 \times \left(1 + \frac{R_3}{R_2}\right)$$

1. Define the full-scale shunt voltage and calculate the maximum shunt resistance.

$$V_{iMax} = 250 \text{ mV} \quad \text{at} \quad I_{iMax} = 1 \text{ A}$$

$$R_1 = \frac{V_{iMax}}{I_{iMax}} = \frac{250 \text{ mV}}{1 \text{ A}} = 250 \text{ m}\Omega$$

2. Calculate the gain required for maximum linear output voltage.

$$V_{iMax} = 250 \text{ mV} \quad \text{and} \quad V_{oMax} = 2.25 \text{ V}$$

$$\text{Gain} = \frac{V_{oMax}}{V_{iMax}} = \frac{2.25 \text{ V}}{250 \text{ mV}} = 9 \frac{\text{V}}{\text{V}}$$

3. Select standard values for R_2 and R_3 .

Let $R_2 = 715 \Omega$ (0.1% Standard Value)

$$\text{Gain} = 9 \frac{\text{V}}{\text{V}} = 1 + \frac{R_3}{R_2} \tag{1}$$

$$R_3 = \left(9 \frac{\text{V}}{\text{V}} - 1\right) * R_2 = 8 * 715 \Omega = 5.72 \text{ k}\Omega \tag{2}$$

Choose $R_3 = 5.69 \text{ k}\Omega$ (0.1% Standard Value)

Note: The feedback resistor ladder (R_2 and R_3) can be realized using the integrated programmable gain resistor ladder of the SAC_L3 with a programmed noninverting gain of 9x. This implementation is showcased in the [MSP430FR2355 code example](#). If the SAC op-amps are being used in general purpose mode, external resistors would be used to build the feedback resistor ladder.

4. Calculate minimum input current before hitting output swing-to-rail limit. I_{iMin} represents the minimum accurately detectable input current.

$$V_{oMin} = 100 \text{ mV}; R_1 = 250 \text{ m}\Omega$$

$$V_{iMin} = \frac{V_{oMin}}{\text{Gain}} = \frac{100 \text{ mV}}{9 \frac{V}{V}} = 11.1 \text{ mV}$$

$$I_{iMin} = \frac{V_{iMin}}{R_1} = \frac{11.1 \text{ mV}}{250 \text{ m}\Omega} = 44.4 \text{ mA}$$

5. Calculate Full scale range error and relative error. V_{os} is the typical offset voltage found in data sheet.

$$\text{FSR}_{\text{error}} = \left(\frac{V_{os}}{V_{iMax} - V_{iMin}} \right) \times 100 = \left(\frac{5 \text{ mV}}{238.9 \text{ mV}} \right) \times 100 = 2.09 \%$$

$$\text{Relative Error at } I_{iMax} = \left(\frac{V_{os}}{V_{iMax}} \right) \times 100 = \left(\frac{5 \text{ mV}}{250 \text{ mV}} \right) \times 100 = 2 \%$$

$$\text{Relative Error at } I_{iMin} = \left(\frac{V_{os}}{V_{iMin}} \right) \times 100 = \left(\frac{5 \text{ mV}}{11.1 \text{ mV}} \right) \times 100 = 45 \%$$

6. To maintain sufficient phase margin, ensure that the zero created by the gain setting resistors and input capacitance of the device is greater than the bandwidth of the circuit

$$\frac{1}{2 \times \pi \times (C_{cm} + C_{diff}) \times (R_2 || R_3)} > \frac{GBP}{G}$$

$$\frac{1}{2 \times \pi \times (3 \text{ pF} + 3 \text{ pF}) \times \left(\frac{715 \Omega \times 5.69 \text{ k}\Omega}{715 \Omega + 5.69 \text{ k}\Omega} \right)} > \frac{4 \text{ MHz}}{9 \frac{V}{V}} = 41.76 \text{ MHz} > 444.4 \text{ kHz}$$

Design Simulations

DC Simulation Results

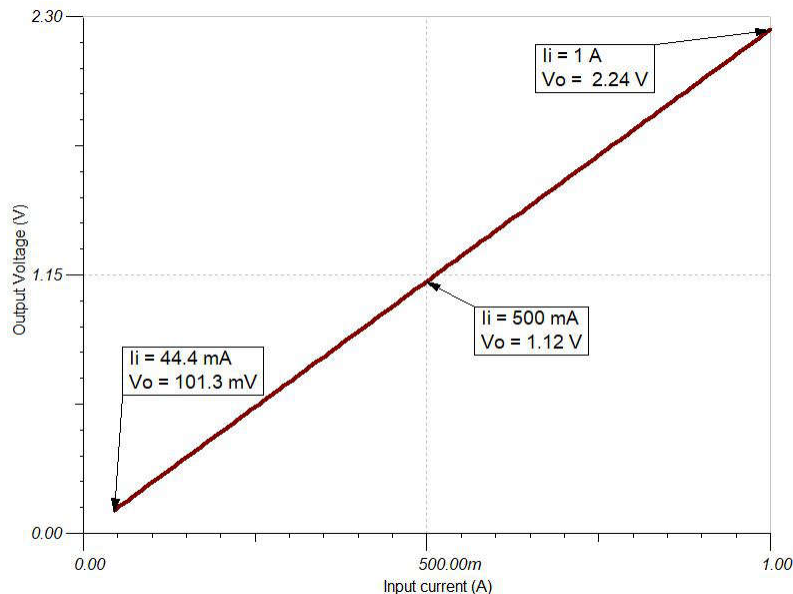

AC Simulation Results

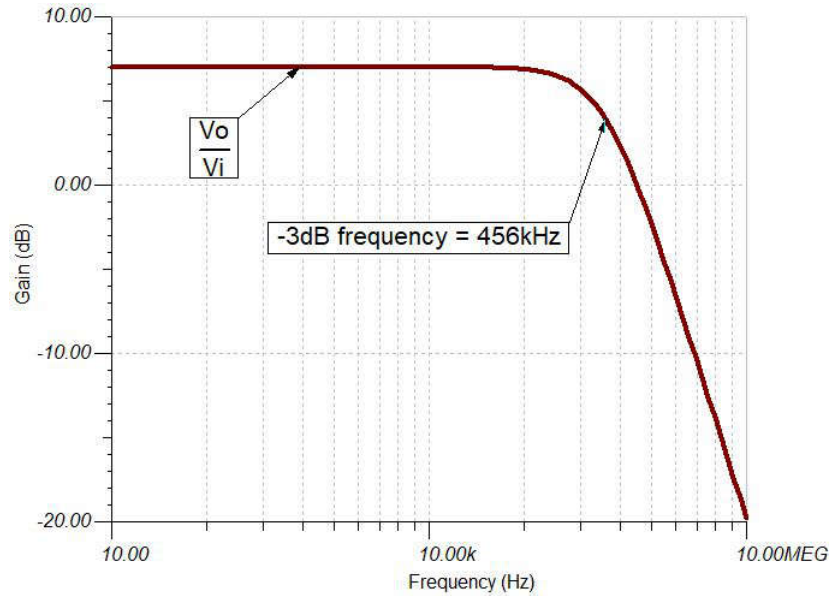

Target Applications

- Cordless power tool battery pack
- E-bike, e-scooter battery pack
- Motor drives
- LED luminaire
- Grid infrastructure

References

1. [MSP430 Single-Supply, Low-Side, Unidirectional Current-Sensing Circuit Code Examples and SPICE Simulation File](#)
2. [Analog Engineer's Circuit Cookbooks](#)
3. [MSP430FR2311 TINA-TI Spice Model](#)
4. [MSP430 MCUs Smart Analog Combo Training](#)





Design Featured Op Amp

MSP430FRxx Smart Analog Combo		
	MSP430FR2311 SAC_L1	MSP430FR2355 SAC_L3
V_{CC}	2.0 V to 3.6 V	
V_{CM}	-0.1 V to $V_{CC} + 0.1$ V	
V_{out}	Rail-to-rail	
V_{os}	±5 mV	
A_{OL}	100 dB	
I_q	350 μ A (high-speed mode)	
	120 μ A (low-power mode)	
I_b	50 pA	
UGBW	4 MHz (high-speed mode)	2.8 MHz (high-speed mode)
	1.4 MHz (low-power mode)	1 MHz (low-power mode)
SR	3 V/ μ s (high-speed mode)	
	1 V/ μ s (low-power mode)	
Number of channels	1	4
	MSP430FR2311	
	MSP430FR2355	

Design Alternate Op Amp

MSP430FR2311 Transimpedance Amplifier	
V_{CC}	2.0 V to 3.6 V
V_{CM}	-0.1 V to $V_{CC}/2$ V
V_{out}	Rail-to-rail
V_{os}	± 5 mV
A_{OL}	100 dB
I_q	350 μ A (high-speed mode)
	120 μ A (low-power mode)
I_b	5 pA (TSSOP-16 with OA-dedicated pin input)
	50 pA (TSSOP-20 and VQFN-16)
UGBW	5 MHz (high-speed mode)
	1.8 MHz (low-power mode)
SR	4 V/ μ s (high-speed mode)
	1 V/ μ s (low-power mode)
Number of channels	1
MSP430FR2311	

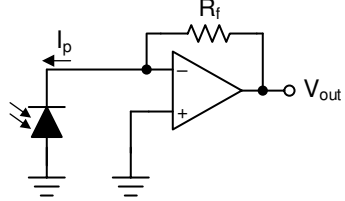
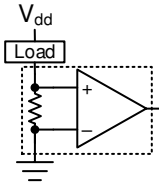
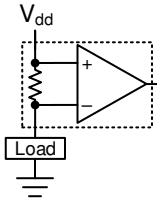
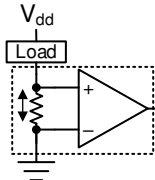
Related MSP430 Circuits

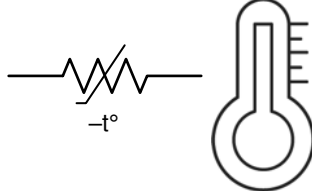
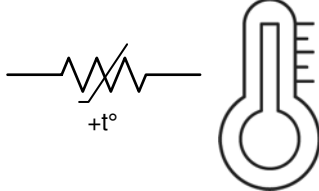
<p>Low-noise and long-range PIR sensor conditioner circuit</p> 	<p>Bridge amplifier circuit</p> 	<p>Transimpedance amplifier circuit</p> 
<p>Single-supply, low-side, unidirectional current-sensing circuit</p> 	<p>High-side current sensing with discrete difference amplifier circuit</p> 	<p>Low-side, bidirectional current-sensing circuit</p> 
<p>Half-wave rectifier circuit</p> 	<p>Temperature sensing with NTC thermistor circuit</p> 	<p>Temperature sensing with PTC thermistor circuit</p> 

Revision History

NOTE: Page numbers for previous revisions may differ from page numbers in the current version.

Changes from November 27, 2019 to March 6, 2020	Page
• Added <i>Related MSP430 Circuits</i> section.....	1

IMPORTANT NOTICE AND DISCLAIMER

TI PROVIDES TECHNICAL AND RELIABILITY DATA (INCLUDING DATA SHEETS), DESIGN RESOURCES (INCLUDING REFERENCE DESIGNS), APPLICATION OR OTHER DESIGN ADVICE, WEB TOOLS, SAFETY INFORMATION, AND OTHER RESOURCES "AS IS" AND WITH ALL FAULTS, AND DISCLAIMS ALL WARRANTIES, EXPRESS AND IMPLIED, INCLUDING WITHOUT LIMITATION ANY IMPLIED WARRANTIES OF MERCHANTABILITY, FITNESS FOR A PARTICULAR PURPOSE OR NON-INFRINGEMENT OF THIRD PARTY INTELLECTUAL PROPERTY RIGHTS.

These resources are intended for skilled developers designing with TI products. You are solely responsible for (1) selecting the appropriate TI products for your application, (2) designing, validating and testing your application, and (3) ensuring your application meets applicable standards, and any other safety, security, regulatory or other requirements.

These resources are subject to change without notice. TI grants you permission to use these resources only for development of an application that uses the TI products described in the resource. Other reproduction and display of these resources is prohibited. No license is granted to any other TI intellectual property right or to any third party intellectual property right. TI disclaims responsibility for, and you will fully indemnify TI and its representatives against, any claims, damages, costs, losses, and liabilities arising out of your use of these resources.

TI's products are provided subject to [TI's Terms of Sale](#) or other applicable terms available either on [ti.com](https://www.ti.com) or provided in conjunction with such TI products. TI's provision of these resources does not expand or otherwise alter TI's applicable warranties or warranty disclaimers for TI products.

TI objects to and rejects any additional or different terms you may have proposed.

Mailing Address: Texas Instruments, Post Office Box 655303, Dallas, Texas 75265
Copyright © 2023, Texas Instruments Incorporated