

TVP5158 Evaluation Module

User's Guide



Literature Number: SLEU108A
November 2009–Revised March 2014

1	Description	5
1.1	Functional Overview	5
1.2	Notational Conventions.....	5
2	Board Level Description	6
2.1	Analog Video/Audio Inputs.....	6
2.2	Analog Video/Audio Outputs.....	6
2.3	Digital Video/Audio Outputs to DaVinci HD EVM	7
2.4	Digital Video/Audio Cascade Output/Input.....	7
2.5	I2C Configuration Options.....	7
2.6	Test Points and Jumpers.....	7
3	System Level Description	8
4	Required Hardware and Equipment	9
5	Hardware Setup	9
5.1	Setup for TVP5158EVM Stand-Alone Configuration	9
5.2	Setup for TVP5158EVM with DaVinci HD EVM	10
6	Software Installation	13
7	TVP5158EVM Evaluation Procedures	16
7.1	Stand-Alone Operation - Non-Interleaved Digital Video Output Modes	16
7.2	Evaluation Using the DaVinci HD EVM.....	19
7.3	Evaluation of Pixel-Interleaved Digital Video Output Modes.....	23
8	VCC Software in Depth	24
8.1	VCC Main Window	24
8.2	Register Map Editor	24
8.3	Property Sheets.....	25
8.4	Video Decoder Select and Write Enables	26
8.5	Example TVP5158 Property Pages	27
9	Troubleshooting	33
9.1	Troubleshooting Guide.....	33
10	TVP5158 EVM Schematics	37
	Revision History	45

List of Figures

1	TVP5158 EVM Block Diagram	6
2	TVP5158EVM System Level Block Diagram.....	8
3	Location of TVP5158EVM Video/Audio Inputs	10
4	TVP5158EVM Software Setup Wizard	13
5	Select Installation Folder	14
6	Confirm Installation.....	14
7	Installation Complete.....	15
8	VCC Configuration	17
9	Specifying Cascaded Devices	17
10	USB Device Not Found Error Message	17
11	Real-Time Polling Enable	18
12	VCC Main Window - Set for Communication to All Decoders.....	18
13	System Initialization for Analog Component YPbPr Video Output.....	18
14	Browse to Command File	21
15	System Initialization for Line-Interleaved Modes	21
16	mcvip_test Demo Application Menu	22
17	System Initialization for Pixel Interleave Modes.....	23
18	TVP5158 Register Map Editor.....	24
19	VCC Main Window – Configured for Broadcast Write Access (default)	27
20	VCC Main Window – Configured for Single Video Decoder Write Access	27
21	TVP5158 Output Formatter Property Page With Decoder 1 Selected	28
22	TVP5158 Output Formatter Property Page With Decoder 4 Selected	29
23	TVP5158 Noise Reduction and Auto Contrast Property Page	30
24	TVP5158 Audio Property Page (Seen Only When Decoder 1 is Selected)	31
25	TDM I2S Audio Data Configuration	32
26	TVP5158 Video Format Property Page	35
27	THS8200 Input Controls / Status Property Page.....	36
28	Schematics (1 of 8)	37
29	Schematics (2 of 8)	38
30	Schematics (3 of 8)	39
31	Schematics (4 of 8)	40
32	Schematics (5 of 8)	41
33	Schematics (6 of 8)	42
34	Schematics (7 of 8)	43
35	Schematics (8 of 8)	44

List of Tables

1	TVP5158EVM Jumper Descriptions	7
2	Jumper Settings for Stand-Alone Configuration	10
3	Hardware Modification for I2S Audio to DM6467	11
4	Jumper Settings for DaVinci HD EVM as TVP5158 I2C Master	12
5	Jumper Settings for PC USB Interface as TVP5158 I2C Master	12
6	Jumper Settings for a Cascaded TVP5158EVM	13
7	Recommended DM6467 Clock Frequencies	19
8	VCC Main Menu Summary	24
9	VCC Register Map Editor Controls	25
10	Property Sheet Controls	25
11	Property Sheet Button Controls	26
12	Editing Tools vs Video Decoder Write Enables	27
13	Troubleshooting Setup and General Issues	33
14	Troubleshooting with THS8200 and CompositeVideo Output	33
15	Troubleshooting with DM6467 DaVinci HD EVM	34
16	Troubleshooting I2C Connections and Cascaded EVMs	34

TVP5158 Evaluation Module

1 Description

The TVP5158EVM evaluation module is a printed circuit board designed for evaluation of the TVP5158 Four-Channel PAL/NTSC Video Decoder. The TMS320DM6467 DVEVM (digital video evaluation module) can be used with the TVP5158EVM as a back-end video processor. This user guide outlines the necessary hardware and software setup required to provide full evaluation of the TVP5158.

1.1 Functional Overview

TVP5158EVM is powered by a single 5-V universal supply. The TVP5158EVM allows the user to have up to four composite video inputs and up to four audio inputs. Analog YPbPr component video output is supported for non-interleaved video modes. Digital video is output to the DaVinci HD EVM in a single or dual ITU-R BT.656 configuration or in ITU-R BT.601 (16-Bit) configuration for evaluation of line-interleaved modes.

The TVP5158EVM uses one PC USB port to provide I2C communication with the TVP5158, THS8200 Video/Graphics Triple DAC and the TLV320DAC32 Stereo Audio DAC devices on the TVP5158EVM. The Video Control Center (VCC) application software is provided for control and evaluation of the TVP5158EVM. A VT100 terminal program is required to connect to the DaVinci HD EVM via UART to send Linux shell commands to control the DSP.

1.2 Notational Conventions

This document uses the following conventions.

The TMS320DM6467 Digital Video Evaluation Module is usually referred to as the DaVinci HD EVM.

The TMS320DM6467 Digital Media System-on-Chip is usually referred to as the DM6467.

2 Board Level Description

Figure 1 shows the various features available on the TVP5158EVM.

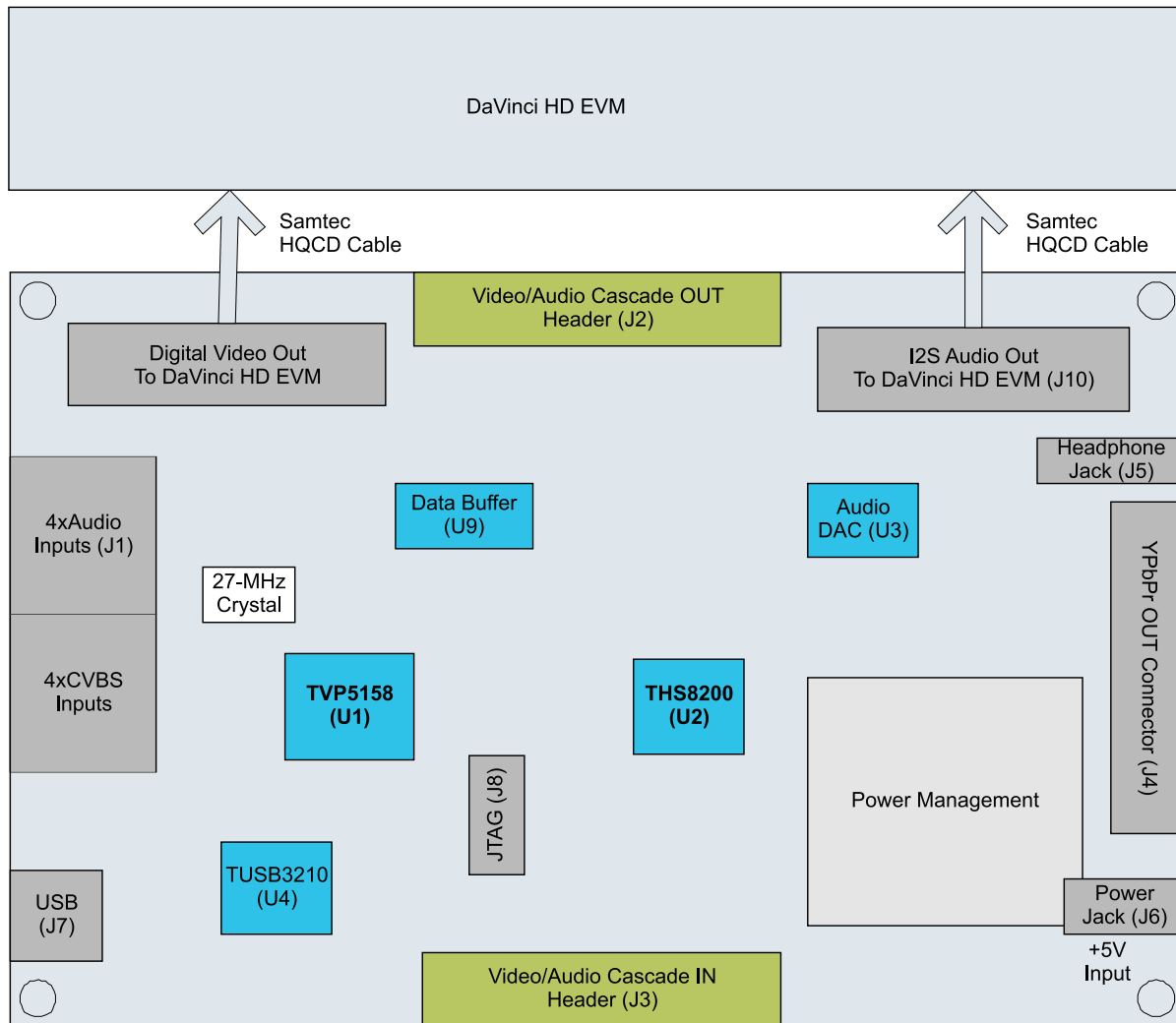

Figure 1. TVP5158 EVM Block Diagram

2.1 Analog Video/Audio Inputs

The TVP5158EVM makes use of all the available inputs on the TVP5158 decoder, including four CVBS video inputs and four analog audio inputs. Connector J1 has four analog video (CVBS) inputs (yellow RCA jacks) and four analog audio inputs (white RCA jacks).

2.2 Analog Video/Audio Outputs

The TVP5158EVM has a THS8200 Video/PC Graphics Triple DAC and a TLV320DAC32 audio DAC on the board so that the user can evaluate video and audio performance using a single EVM setup. The THS8200 Video/Graphics Triple DAC takes the video output from DVO port A of TVP5158 and outputs analog YPbPr video signals to component output connector J4. The TLV320DAC32 Stereo Audio DAC takes digital audio output from TVP5158 and outputs analog audio to the head phone jack J5.

2.3 Digital Video/Audio Outputs to DaVinci HD EVM

The TVP5158EVM has two dedicated connectors which match the digital video/audio input connectors on the DaVinci HD EVM. Connector J9 includes a 16-bit video data bus (buffered data from DVO_A and DVO_B of TVP5158), OCLK_P, OCLK_N, I2C and interrupts. The connector J10 includes BCLK, LRCLK and SD_R/SD_M outputs from TVP5158. Samtec HQCD cables are required to connect TVP5158EVM digital video and audio signals to the DaVinci HD EVM.

2.4 Digital Video/Audio Cascade Output/Input

The TVP5158EVM has two connectors for video/audio cascade mode test. The connector J2 is for video/audio cascade output, which includes buffered data from the DVO_A and DVO_B video output ports and audio cascade output from TVP5158. The connector J3 is for video/audio cascade input, which includes video input data to the DVO_C and DVO_D video ports and audio cascade input from a lower cascaded stage TVP5158 device.

2.5 I2C Configuration Options

The TVP5158EVM uses one PC USB port for I2C communication. The I2C bus master can be changed based on jumper settings. Control is via the PCB USB interface (VCC application controls TVP5158), via the DaVinci EVM (DSP driver software controls TVP5158) or via the cascade input/output connectors J3 or J2.

2.6 Test Points and Jumpers

Various test points are available on the TVP5158EVM for the user. This includes the various power supplies as well as a few GND test points. The user can also use J2/J3 for primary test-point headers to access video/audio data, video/audio clocks, I2C and GND.

There are several jumpers available on the TVP5158EVM that configure I2C address select, I2C control configuration, clock source selection and I2S source select. Each jumper is set by default in its preferred state for the TVP5158EVM. Next to each jumper on the TVP5158EVM is the silkscreen that describes the various jumper configurations. If the I2C address is changed on the TVP5158EVM while the TVP5158EVM is powered up, then that device will not recognize the new I2C address. The reset button on the TVP5158EVM must be pressed and the VCC application must be exited, restarted, and re-configured for the new I2C address. [Table 1](#) shows the TVP5158EVM jumper settings.

Table 1. TVP5158EVM Jumper Descriptions

Jumper Designator	Description of Function	Default
W0	TVP5158 I2C address selection (I2C_A0) 1-2: Low 2-3: High	1-2
W1	TVP5158 I2C address selection (I2C_A1) 1-2: Low 2-3: High	1-2
W2	TVP5158 I2C address selection (I2C_A2) 1-2: Low 2-3: High	1-2
W3	I2C SDA source selection 1-2: USB controls I2C 2-3: DaVinciHD controls I2C OFF: Control by another EVM for cascade mode.	1-2
W4	I2C SCL source selection 1-2: USB controls I2C 2-3: DaVinciHD controls I2C OFF: Control by another EVM for cascade mode.	1-2
W5	Clock source selection 1-2: Crystal 2-3: Clock from another EVM for cascade mode	1-2

Table 1. TVP5158EVM Jumper Descriptions (continued)

Jumper Designator	Description of Function	Default
W6	I2C EEPROM ON: Use EEPROM (MUST ALWAYS BE ON)	ON
W7	I2C SCL connection for audio DAC	ON
W8	I2C SDA connection for audio DAC	ON
W9	I2S input selection for audio DAC 1-2: TVP5158 mixing output to audio DAC (SD_M) 2-3: TVP5158 record output to audio DAC (SD_R)	2-3

3 System Level Description

The system block diagram illustrated in [Figure 2](#) provides an example of how the TVP5158EVM may be used for evaluation. Typically, the analog video/audio input is provided by a video source such as a pattern generator or a DVD player running a test DVD. The TVP5158EVM is configured with the 5-V supply and the USB cable provided.

The TVP5158EVM analog video output is standard definition component video (YPbPr). These outputs are then fed into a high-end or studio-quality NTSC/PAL monitor.

The user can also connect the TVP5158EVM to a DaVinci HD EVM and then output combined video from the DaVinci HD EVM to a 1080i HD monitor.

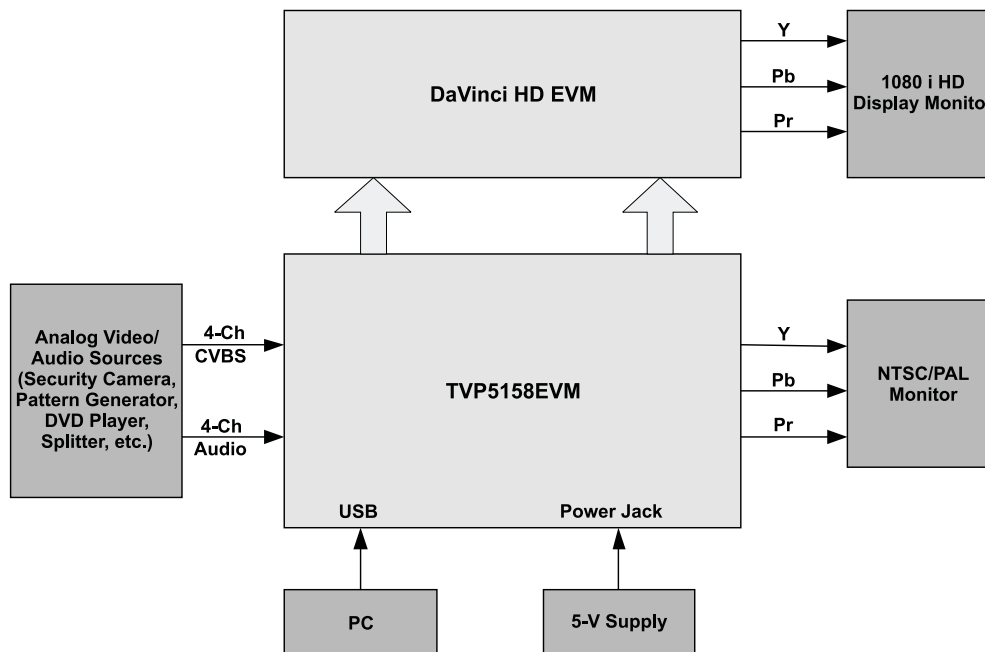
Figure 2. TVP5158EVM System Level Block Diagram

4 Required Hardware and Equipment

The required hardware and equipment are as follows:

- Windows-based PC with Windows XP or later
- Video sources (security camera, pattern generator, DVD player, etc.)
- Display monitor that supports
 - 1080i component YPbPr video (50 and 60 Hz)
 - 480i and 576i component YPbPr video
- Audio amplifier/speakers or headphones
- TVP5158EVM (provided)
 - Cables to provide up to four composite video and up to four audio line inputs
 - Component Video (YPbPr) cable for output
 - USB cable (provided)
 - Universal 5-V power supply (100 to 240 VAC in, 5 VDC/3.0 A out) (provided)
- DaVinci HD EVM
 - Two Samtec HQCD cables
 - Component video (YPbPr) cable for output
 - RS-232 null MODEM cable
 - Universal 5-V power supply (100 to 250 VAC in, 5 VDC/5.0 A out)

5 Hardware Setup

The following sections describe the hardware setup for evaluation of the TVP5158.

5.1 Setup for TVP5158EVM Stand-Alone Configuration

For evaluation of video quality, comb filter, noise reduction, auto-contrast and other features, the TVP5158EVM can be setup in a stand-alone configuration. Analog video and audio sources are input to TVP5158. TVP5158 outputs digital video as ITU-R BT.656 or ITU-R BT.601 non-interleaved video to the THS8200 PC Graphics/Video Triple DAC. Component Video YPbPr from the THS8200 is output in 480i or 576i format to a video monitor. To setup the stand-alone configuration, make the following connections:

1. Analog video sources to TVP5158EVM composite video inputs (see [Figure 3](#))
2. Analog audio sources to TVP5158EVM audio line inputs (see [Figure 3](#))
3. Analog component YPbPr video out from TVP5158EVM to video monitor
4. Stereo audio headphone output from TVP5158EVM to audio amplifier/speakers or headphones
5. USB cable from PC to TVP5158EVM. A green LED should be lit indicating that the EVM is ready for communication on the USB.
6. 5-V power supply to the dc jack on the TVP5158EVM

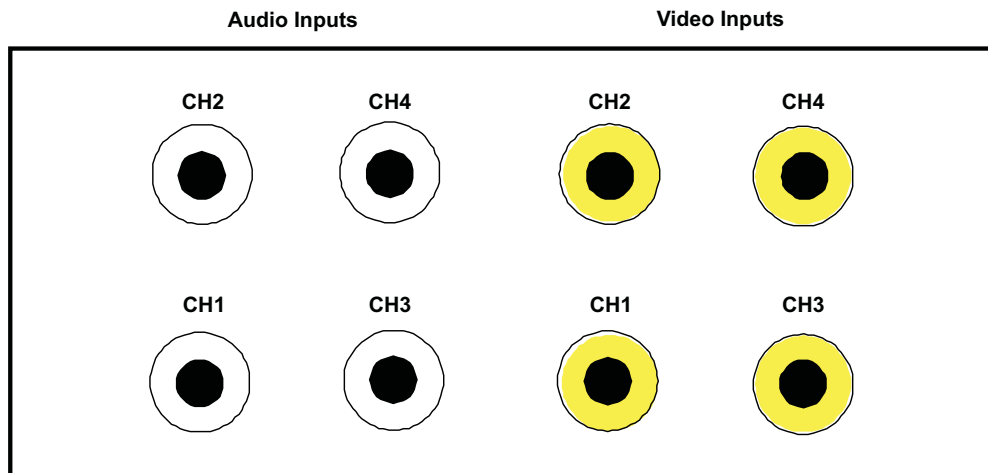

Figure 3. Location of TVP5158EVM Video/Audio Inputs

Table 2. Jumper Settings for Stand-Alone Configuration

Jumper Designator	Function	Setting	Comment
W2, W1, W0	TVP5158 I2C address selection	1-2, 1-2, 1-2	Slave address 0xB0 (1011 LLL0)
W3, W4	I2C master selection	1-2, 1-2	PC USB port controls TVP5158 I2C
W7, W8	I2C connection to audio DAC	ON, ON	Connected
W9	I2S selection to audio DAC	2-3 or 1-2	Monitor record I2S output or mixer I2S output from TVP5158

5.2 Setup for TVP5158EVM with DaVinci HD EVM

The TMS320DM6467 DVEVM (digital video evaluation module) can be used as the audio/video back-end processor for evaluation of TVP5158. This EVM is available separately from Texas Instruments and is referred to as the DaVinci HD EVM in this document.

This configuration allows evaluation of all line-interleaved video output formats with up to four channels in D1, Half-D1 or CIF resolution. Eight-channel line-interleaved video is also possible if two TVP5158EVM boards are cascaded together.

Sample video and audio driver code and a demo application are provided to run on the TMS320DM6467 on the Linux O/S.

To setup the TVP5158EVM with DaVinci HD EVM configuration, make the following connections:

1. Analog video sources to TVP5158EVM composite video inputs (see [Figure 3](#))
2. Analog audio sources to TVP5158EVM audio line inputs (see [Figure 3](#))
3. Analog component YPbPr video out from DaVinci HD EVM to monitor
4. USB cable from PC to TVP5158EVM. A green LED should be lit indicating that the EVM is ready for communication on the USB.

NOTE: If the VCC GUI Software for TVP5158 is not used, it is not necessary to connect the TVP5158EVM to a PC USB port.

5. RS-232 null MODEM cable from PC to DaVinci HD EVM
6. 5-V power supply to the dc jack on the TVP5158EVM
7. 5-V power supply to the dc jack on the DaVinci HD EVM
8. Ethernet cable from LAN to DaVinci HD EVM

5.2.1 Additional Setup when DSP Processes Video Only

In this configuration, digital video goes to the DaVinci HD EVM. Digital I2S audio goes to the TLV320DAC32 Audio DAC on the TVP5158EVM. Stereo audio output can then be taken from the TVP5158EVM headphone jack. Make the following additional connections:

1. Samtec HQCD ribbon cable from TVP5158EVM DaVinci Video connector to the DaVinci HD EVM DC_P2 Video Expansion connector.
2. TVP5158EVM headphone jack to audio amplifier/speakers or headphones

5.2.2 Additional Setup When DSP Processes Video and Audio

CAUTION

A modification to both the TVP5158EVM and the DaVinci HD EVM must be made if I2S digital audio is to be processed by the DM6467 DSP (see [Section 5.2.2.1](#)).

In this configuration, digital video and digital audio go to the DaVinci HD EVM. For the digital audio connection, a hardware modification is required as described in Section 5.2.2.1. The stereo audio is then output from the DaVinci HD EVM headphone jack. After making the hardware modification, make the following additional connections:

1. Samtec HQCD ribbon cable from TVP5158EVM DaVinci Video connector to the DaVinci HD EVM DC_P2 Video Expansion connector
2. Samtec HQCD ribbon cable from TVP5158EVM DaVinci Audio connector to DaVinci HD EVM DC_P3 I/O Expansion connector
3. DaVinci HD EVM headphone jack to audio amplifier/speakers or headphones

5.2.2.1 Hardware Modification for I2S Audio to DM6467 DSP

Three 0-Ω resistors must be removed from the TVP5158EVM and three 0-Ω resistors must be removed from the DaVinci HD EVM according to [Table 3](#).

Table 3. Hardware Modification for I2S Audio to DM6467

Remove From TVP5158EVM	Remove From DaVinci HD EVM
R42 SD_M	R13 MCASP0_ACLKR
R98 MCASP0_EN	R17 MCASP0_AFSR
R99 AUDIO_CLK_EN	R31 MCASP0_AXR1

NOTE: After this modification has been made, the SD_M I2S digital audio output from TVP5158 will no longer be available. The SD_R output must be used and W9 must be jumpered 2-3. If headphone output from the TVP5158EVM is to be tested using the audio mixer (SD_M I2S output), 0-ohm resistor R42 must be reinstalled and W9 must be jumpered 1-2.

5.2.3 Jumper Settings with DaVinci HD EVM

When the DaVinci HD EVM is used, the video and/or audio driver software can be set to control the entire system, or can be set to skip I2C programming of the TVP5158. In the latter case, the PC USB interface and the Video Control Center application software are used to initialize and experiment with TVP5158 register settings through a graphical user interface.

5.2.3.1 DaVinci HD EVM as TVP5158 I2C Master

Table 4 describes the jumper settings to set the DaVinci HD EVM as I2C master for the TVP5158. In this case, the Linux application and driver software control the entire system. Audio can be output from the TVP5158EVM or from the DaVinci HD EVM. See Section 5.2.1 and Section 5.2.2 for audio configurations.

Table 4. Jumper Settings for DaVinci HD EVM as TVP5158 I2C Master

Jumper Designator	Function	Setting	Comment
W2, W1, W0	TVP5158 I2C Address selection	1-2, 1-2, 1-2	Slave address 0xB0 (1011 LLL0)
W3, W4	I2C master selection	2-3, 2-3	DaVinci HD EVM controls TVP5158 I2C
W7, W8	I2C connection to audio DAC	ON, ON	Connected
W9	I2S selection to audio DAC	2-3 or 1-2	Monitor record I2S output or mixer I2S output from TVP5158

5.2.3.2 PC USB as TVP5158 I2C Master with DaVinci HD EVM

Table 5 describes the jumper settings to set the PC USB interface as I2C master for the TVP5158. In this case, the Video Control Center application software can be used to experiment with TVP5158 register settings through a graphical user interface.

NOTE: This system configuration has known I2C issues that sometimes occur when PC USB and DaVinci HD EVM I2C buses are used independently.

Table 5. Jumper Settings for PC USB Interface as TVP5158 I2C Master

Jumper Designator	Function	Setting	Comment
W2, W1, W0	TVP5158 I2C address selection	1-2, 1-2, 1-2	Slave address 0xB0 (1011 LLL0)
W3, W4	I2C master selection	1-2, 1-2	PC USB port controls TVP5158 I2C
W7, W8	I2C connection to audio DAC	ON, ON	Connected
W9	I2S selection to audio DAC	2-3 or 1-2	Monitor record I2S output or mixer I2S output from TVP5158

5.2.3.3 Jumper Settings for Audio/Video Cascade Configuration

CAUTION

If two or more TVP5158EVM boards are cascaded together, care must be taken that the leads on the J2 and J3 connectors are in alignment, because the connectors are not keyed.

Table 6 describes the jumper settings for a second stage TVP5158EVM connected for video/audio cascade operation. In this case, the I2C slave address must be set differently than the first EVM. The I2C Master jumpers must be removed to allow the first stage EVM to control I2C (either from USB or from DaVinci HD EVM). USB should be connected to the first stage EVM if used. The Audio DAC I2C must be disconnected on the second stage, since they are both at the same I2C slave address.

Table 6. Jumper Settings for a Cascaded TVP5158EVM

Jumper Designator	Function	Setting	Comment
W2, W1, W0	TVP5158 I2C address selection	1-2, 1-2, 2-3	Slave address 0xB2 (1011 LLH0)
W3, W4	I2C master selection	OFF, OFF	Stage 1 TVP5158EVM controls TVP5158 I2C
W7, W8	I2C connection to audio DAC	OFF, OFF	Disconnected
W9	I2S selection to audio DAC	2-3	Not used

6 Software Installation

If the TVP5158EVM Software has previously been installed on the PC, it is necessary to uninstall the previous version. To uninstall:

1. Click Start > Control Panel > Add or Remove Programs.
2. Wait for the list to populate.
3. Scroll down and click on "TVP5158EVM Software" to highlight it.
4. Click the remove button.
5. When prompted with Are you sure you want to remove TVP5158EVM Software from your computer?, click Yes.

The TVP5158EVM software installation program is contained in a ZIP archive file containing the following two files:

Setup.exe
TVP5158EVM_Software.msi

Unzip these two files to a temporary directory and run setup.exe. The dialog box in [Figure 4](#) appears. Click Next on the dialog boxes shown in [Figure 4](#), [Figure 5](#), and [Figure 6](#). When the installation is finished, the dialog box shown in [Figure 7](#) appears. Click Close to complete the installation.

Documentation and a shortcut to the VCC application can now be found in the Windows start menu at:

Start > All Programs > TVP5158EVM > TVP5158EVM Software
Start > All Programs > TVP5158EVM > TVP5158EVM User Guide

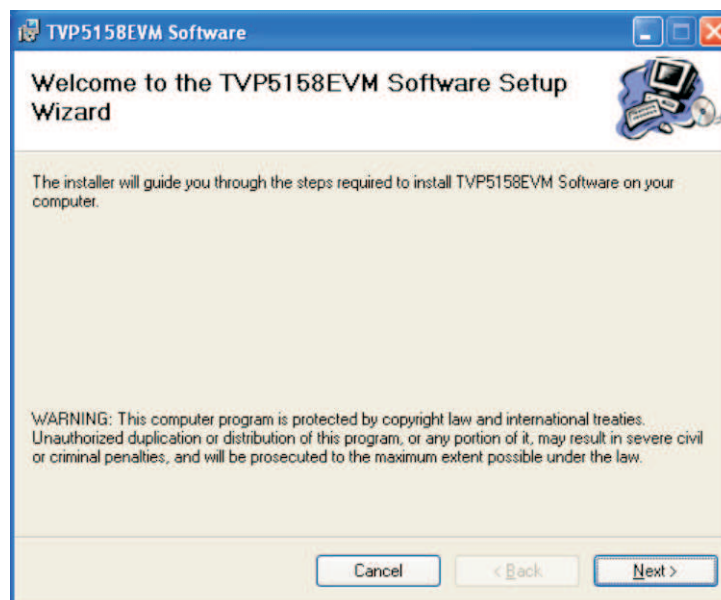
Figure 4. TVP5158EVM Software Setup Wizard

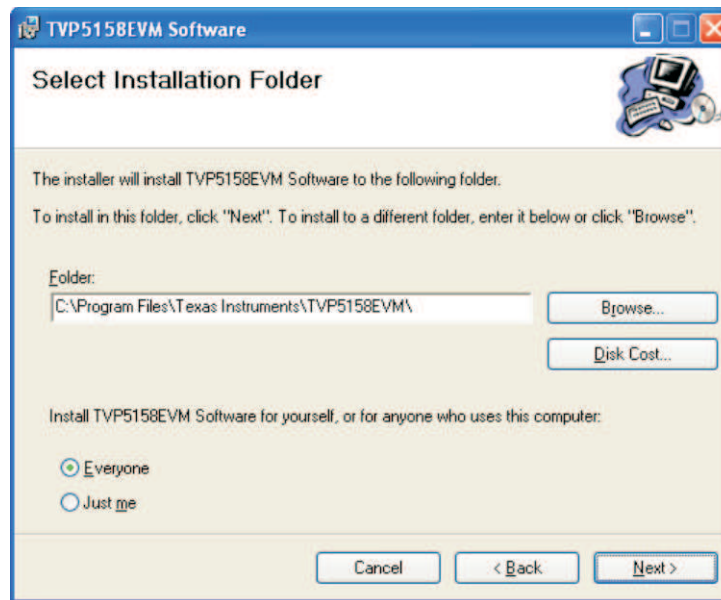

Figure 5. Select Installation Folder

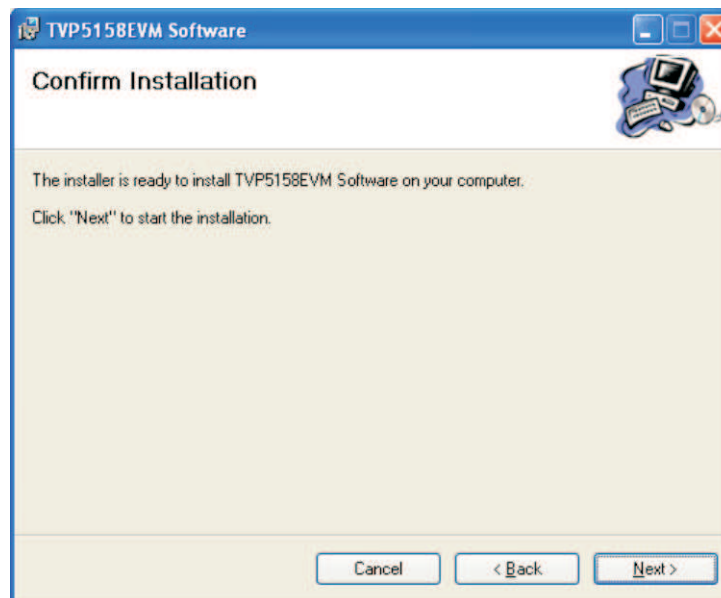

Figure 6. Confirm Installation

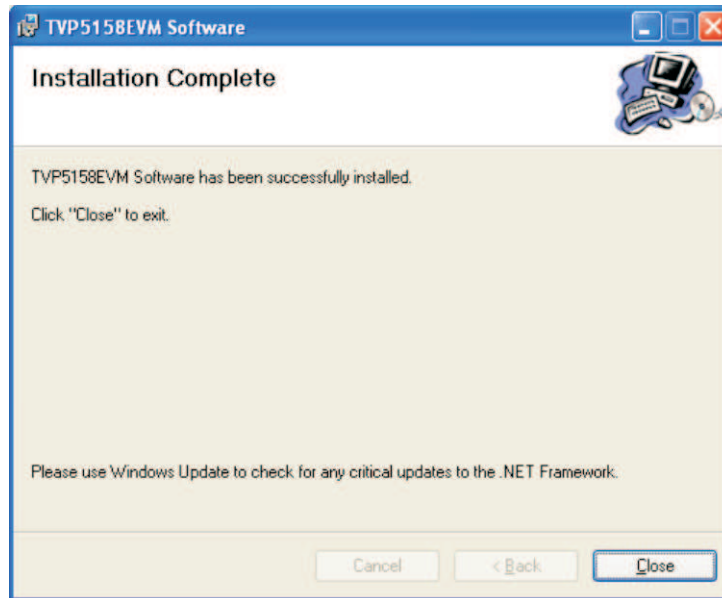

Figure 7. Installation Complete

7 TVP5158EVM Evaluation Procedures

7.1 Stand-Alone Operation - Non-Interleaved Digital Video Output Modes

The following is the procedure for evaluation of TVP5158 for non-interleaved modes. The digital video output from TVP5158 is converted to analog component YPbPr video using a THS8200 Video/PC Graphics Triple DAC:

1. Double-click the TVP5158EVM Software icon on the Windows desktop to start the VCC application.
2. The VCC Configuration dialog box appears (see [Figure 8](#)). Click OK to continue.
3. The Cascaded Devices dialog box appears (see [Figure 9](#)). Click OK to continue. If a message appears indicating that the USB device was not found (see [Figure 10](#)), disconnect the USB cable, wait three seconds and reconnect the USB cable.
4. After 3 to 5 seconds, the Real-Time Polling dialog box appears (see [Figure 11](#)). Click OK to continue.
5. The VCC main window appears (see [Figure 12](#)).
6. Set video source(s) to the NTSC video standard (for this example).
7. Click the Tools > System Initialization menu item. The System Initialization dialog box (see [Figure 13](#)) appears. Click once on the following table entry:
TVP5158 + THS8200, NTSC, Non-Interleaved, 1-Ch D1, Quad BT.656 @ 27 MHz
Click the PROGRAM button. The TVP5158 is now programmed for the NTSC standard using the above video output format. The output formatter is bypassed.
8. To select a video input:
 - (a) In the VCC main window, select the video decoder for the video input to be displayed. This will select which source is used to detect the video standard for updating THS8200 register settings.
 - (b) In System Initialization table, click once on one of the following table entries to select the video channel to be displayed and click the Program button.
 - Select Ch-1 Video Input
 - Select Ch-2 Video Input
 - Select Ch-3 Video Input
 - Select Ch-4 Video Input
9. Video from the selected video input should now be seen on the monitor and audio channels 1 and 2 should be heard from the left and right speakers respectively.

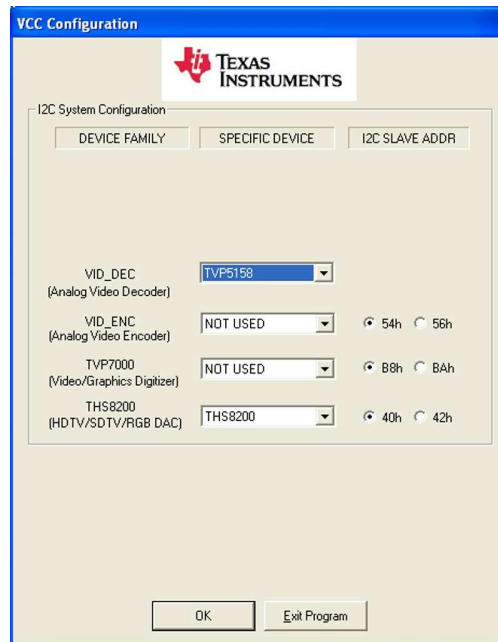

Figure 8. VCC Configuration

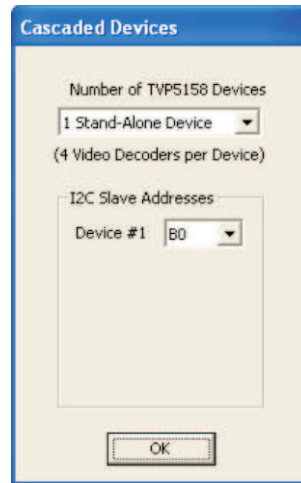

Figure 9. Specifying Cascaded Devices



Figure 10. USB Device Not Found Error Message

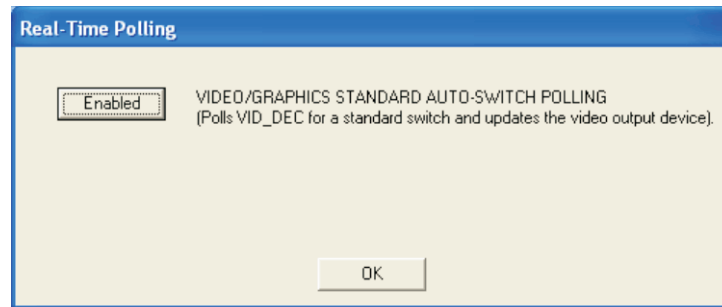

Figure 11. Real-Time Polling Enable

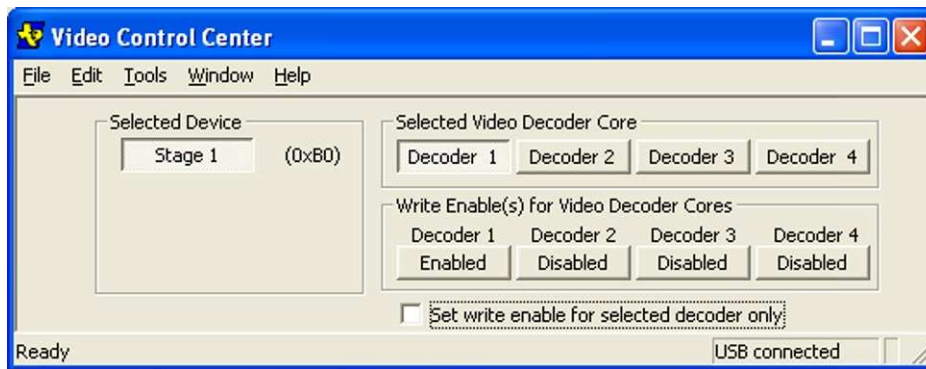

Figure 12. VCC Main Window - Set for Communication to All Decoders

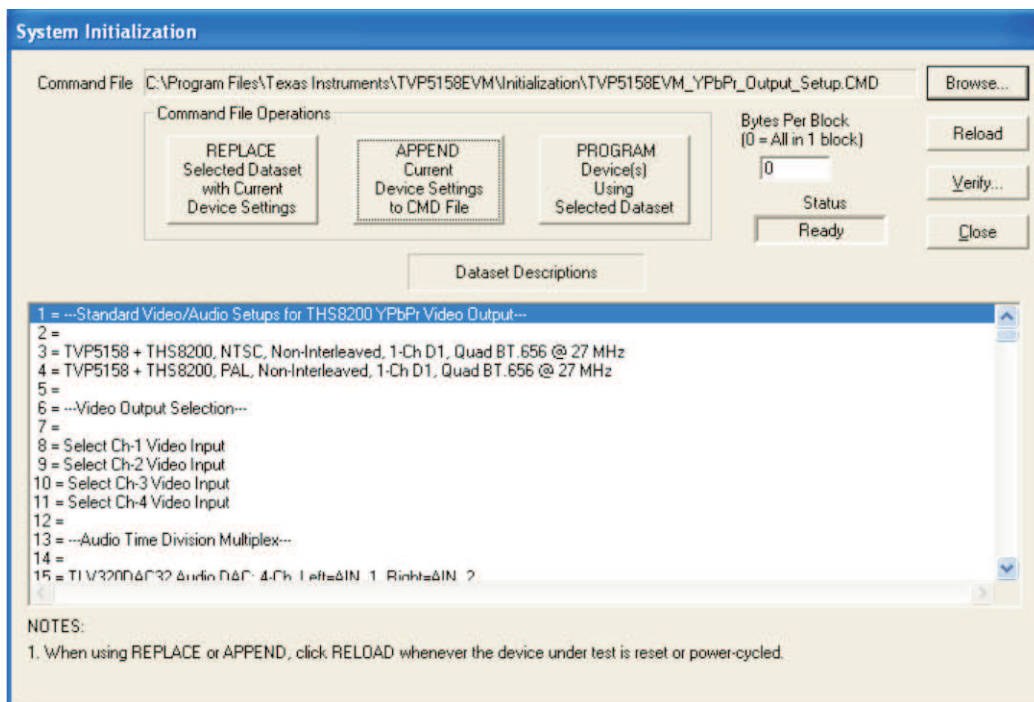

Figure 13. System Initialization for Analog Component YPbPr Video Output

7.2 Evaluation Using the DaVinci HD EVM

7.2.1 Setting DM6467 ARM and DDR2 Memory Clock Rates

For maximum performance, in a system using DM6467 and TVP5158(s) in the line-interleaved video modes, the DM6467 clock frequencies should be set as specified in [Table 7](#).

Table 7. Recommended DM6467 Clock Frequencies

ARM Clock	675 MHz
DDR2 Memory Clock	324 MHz ⁽¹⁾

⁽¹⁾ DaVinci HD EVM assembly revision F or later is required.

Since the DaVinci HD EVM is not packaged with the TVP5158, it is usually necessary to program its NAND flash memory to the recommended clock frequencies, as described by the following procedure:

1. Unzip the UBL_DM646x_NAND_675_324.zip archive file onto the PC's local hard drive. Suggested location is C:\UBL
2. Connect a null MODEM 9-pin serial cable from the DaVinci HD EVM UART connector to the PC COM1 serial port.
3. Close any open program that is using the COM1 serial port.
4. Turn OFF the DaVinci HD EVM power switch.
5. Set SW3 Boot Mode Configuration positions 1-3 to OFF and position 4 to ON to select UART0 Flash Boot. SW3 is located beneath the Samtec HQCD digital video ribbon cable. In the OFF position, the switch is moved toward the PCI connector.
6. In the Windows Start menu, click Run, type cmd, and click OK to open a command window.
7. Execute these commands in the command window:

```
cd \ubl
sfh_DM646x.exe -nandflash UBL_DM646x_NAND_675_324.bin u-boot.bin
```
8. After the Waiting for the DM646x... message appears in the terminal window, turn ON the DaVinci HD EVM power switch.
9. After flash programming has completed, turn OFF the DaVinci HD EVM power switch. Set the SW3 Boot Mode Configuration positions 1-3 to ON and position 4 to OFF to select NAND Flash boot mode.

7.2.2 Evaluation Procedure for Line-Interleaved Video Output Modes

The following are the instructions for evaluation of TVP5158 for line-interleaved modes. The digital video output from TVP5158 is captured using a DM6467 DaVinci HD EVM and is demultiplexed and displayed on a 1080i HD monitor.

7.2.2.1 DaVinci HD EVM Boot

1. Start the VT100 terminal application of your choice. For example, HyperTerminal can be started in Windows XP using these steps:
 - (a) Click Start > All Programs > Accessories > Communications > HyperTerminal.
 - Set "Connect using" to:
 - COM1 (or other available serial port)
 - Set "Port Settings" to:
 - Bits per second: 115200
 - Data bits: 8
 - Parity: None
 - Stop bits: 1
 - Flow control: None
2. Turn ON the DaVinci HD EVM power switch. It may be necessary to halt the boot process (by striking a key at the terminal) to modify boot parameters (especially the first time). For details of the boot

methods see separate documentation that is provided with the DaVinci HD EVM: *TMS320DM6467 DVEVM Getting Started Guide* ([SPRUF88](#)).

NOTE: See the `mcvip_tvp5158\README.TXT` file for instructions on running or building target image and application. This is found in the zip file containing the DaVinci HD video/audio driver source code.

7.2.2.2 Setup DaVinci HD Video / Audio Drivers

Once the DaVinci HD EVM boot has completed, the login: prompt appears at the terminal. Copy and paste the Linux commands below to set up the video capture and audio driver software. In place of `<program_directory>`, insert the directory path where the driver files are stored.

```
root
cd <program_directory>
insmod cmemk.ko phys_start=0x87800000 phys_end=0x8ba00000 pools=1x1000
./mapdmaq-hd
insmod drv.ko
mknod /dev/dev_i2c c 251 0
mknod /dev/dev_dma c 250 0
```

7.2.2.3 Start VCC Application (Optional – Provides GUI Interface for TVP5158)

1. Double-click the TVP5158EVM Software icon on the Windows desktop to start the VCC application.
2. The VCC Configuration dialog box appears (see [Figure 8](#)). Set THS8200 device family to NOT USED. Click OK to continue.
3. The Cascaded Devices dialog box appears (see [Figure 9](#)). Click OK to continue. If a message appears indicating that the USB device was not found (see [Figure 10](#)), disconnect the USB cable, wait three seconds, and reconnect the USB cable.

NOTE: If a second TVP5158EVM is used for cascade operation select "2 Devices Cascaded" and I2C slave addresses 0xB0 and 0xB2.

4. The VCC main window appears (see [Figure 12](#)).
5. Click the Tools > System Initialization menu item. The System Initialization dialog box appears (see [Figure 13](#)).
6. Click the Browse... button. The Open dialog box appears (see [Figure 14](#)). Double-click the file `TVP5158EVM_DaVinci_HD_Setup.CMD`

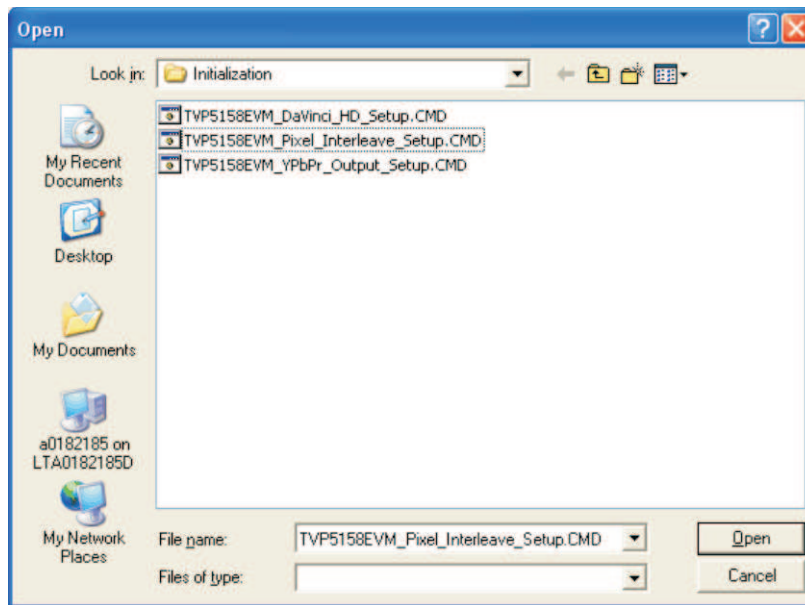

Figure 14. Browse to Command File

The dataset descriptions table should now appear (see Figure 15).

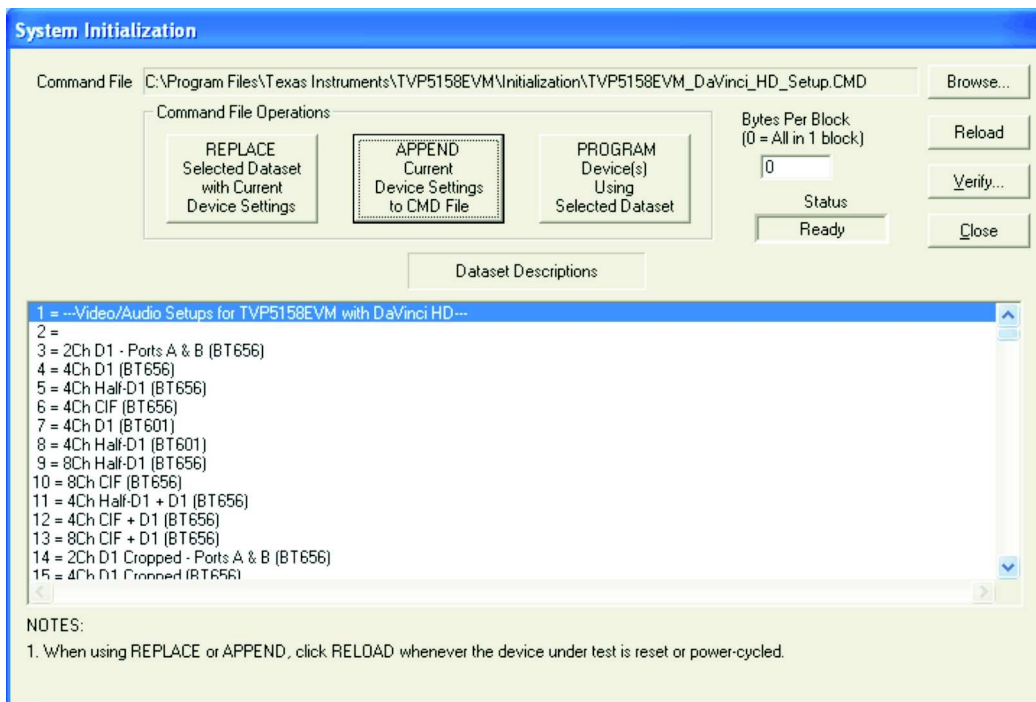
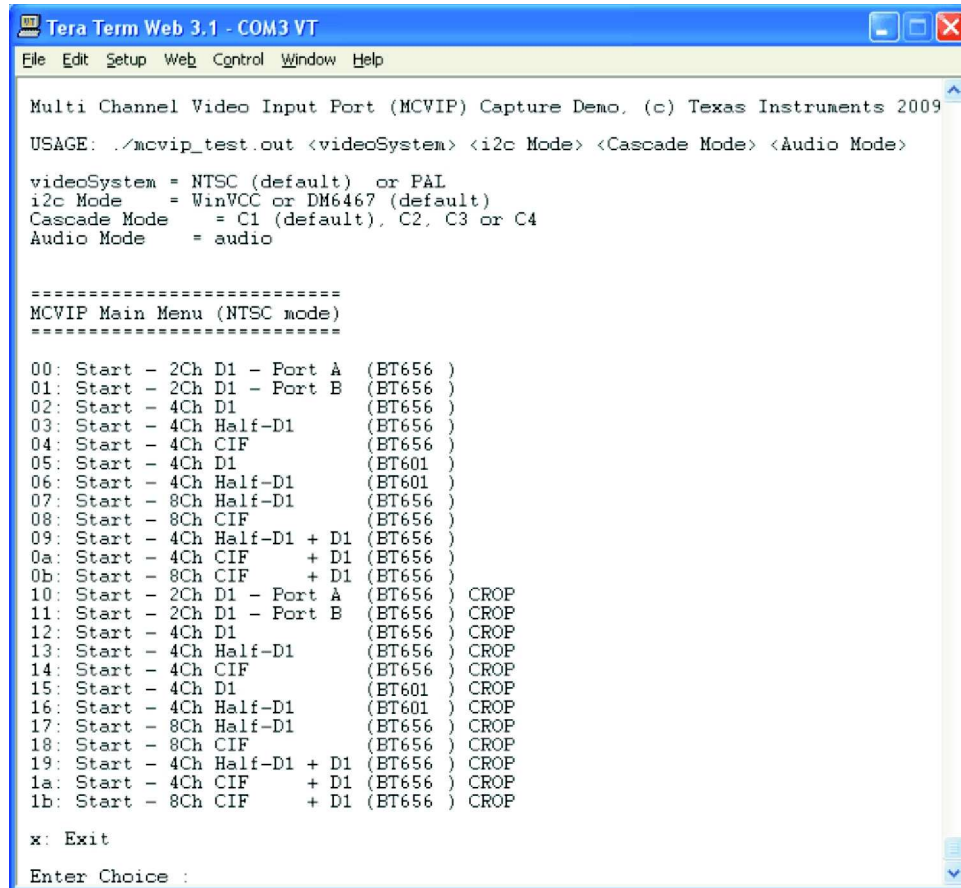

Figure 15. System Initialization for Line-Interleaved Modes

7.2.2.4 mcvip_test Demo Application

The syntax and main menu of the mcvip_test (multi-channel video interface port) demo application is shown in Figure 16.



```

Tera Term Web 3.1 - COM3 VT
File Edit Setup Web Control Window Help

Multi Channel Video Input Port (MCVIP) Capture Demo. (c) Texas Instruments 2009
USAGE: ./mcvip_test.out <videoSystem> <i2c Mode> <Cascade Mode> <Audio Mode>

videoSystem = NTSC (default) or PAL
i2c Mode     = WinVCC or DM6467 (default)
Cascade Mode = C1 (default), C2, C3 or C4
Audio Mode   = audio

=====
MCVIP Main Menu (NTSC mode)
=====
00: Start - 2Ch D1 - Port A (BT656 )
01: Start - 2Ch D1 - Port B (BT656 )
02: Start - 4Ch D1          (BT656 )
03: Start - 4Ch Half-D1    (BT656 )
04: Start - 4Ch CIF        (BT656 )
05: Start - 4Ch D1         (BT601 )
06: Start - 4Ch Half-D1    (BT601 )
07: Start - 8Ch Half-D1    (BT656 )
08: Start - 8Ch CIF        (BT656 )
09: Start - 4Ch Half-D1 + D1 (BT656 )
0a: Start - 4Ch CIF + D1   (BT656 )
0b: Start - 8Ch CIF + D1   (BT656 )
10: Start - 2Ch D1 - Port A (BT656 ) CROP
11: Start - 2Ch D1 - Port B (BT656 ) CROP
12: Start - 4Ch D1          (BT656 ) CROP
13: Start - 4Ch Half-D1    (BT656 ) CROP
14: Start - 4Ch CIF        (BT656 ) CROP
15: Start - 4Ch D1         (BT601 ) CROP
16: Start - 4Ch Half-D1    (BT601 ) CROP
17: Start - 8Ch Half-D1    (BT656 ) CROP
18: Start - 8Ch CIF        (BT656 ) CROP
19: Start - 4Ch Half-D1 + D1 (BT656 ) CROP
1a: Start - 4Ch CIF + D1   (BT656 ) CROP
1b: Start - 8Ch CIF + D1   (BT656 ) CROP

x: Exit
Enter Choice :
    
```

Figure 16. mcvip_test Demo Application Menu

7.2.2.5 Procedure for Initializing Individual Video Formats

The procedure for initializing the system for each individual video output format is as follows:

1. Start the mcvip_test application (do not enter the menu option yet).
Example: ./mcvip_test.out NTSC VCC <Cascade Mode Option> <Audio Mode Option>
2. Program TVP5158 for the video output format (only if using VCC GUI Software).
In the VCC System Initialization window, click on the video output format (same format as chosen in step 3) and click the PROGRAM button.
3. Select the video capture format for the DaVinci HD EVM:
In terminal window, type video format menu option (00-1b) and then <Enter>.
The video output should now be displayed on the HD video monitor using 1080i format.
4. At Linux terminal, type 0 <return> to stop the video capture.
5. Audio should be heard from the left and right speakers respectively if audio mode option selected.

Repeat steps 1 through 4 for each line-interleaved video output format.

7.3 Evaluation of Pixel-Interleaved Digital Video Output Modes

The TVP5158EVM can be programmed for pixel-interleaved modes as described below. The DM6467 DaVinci HD EVM does not support pixel interleave modes, so a different back-end processor is required for this evaluation.

1. In the VCC System Initialization dialog box, click the Browse button. The Open dialog box shown in [Figure 14](#) appears. Double-click the following file:

TVP5158EVM_Pixel_Interleave_Setup.CMD

2. The dataset descriptions table should now appear as shown in [Figure 17](#). Click once on the following table entry:

Multi-Standard, Pixel-Interleave, 2-Ch D1, 8-bit @ 54MHz (OCLK_P, OCLK_N @ 27MHz, Opposite Phase)

Click the PROGRAM button. The TVP5158 is now programmed to automatically detect the video standard received at the input and output video in the above pixel-interleaved format.

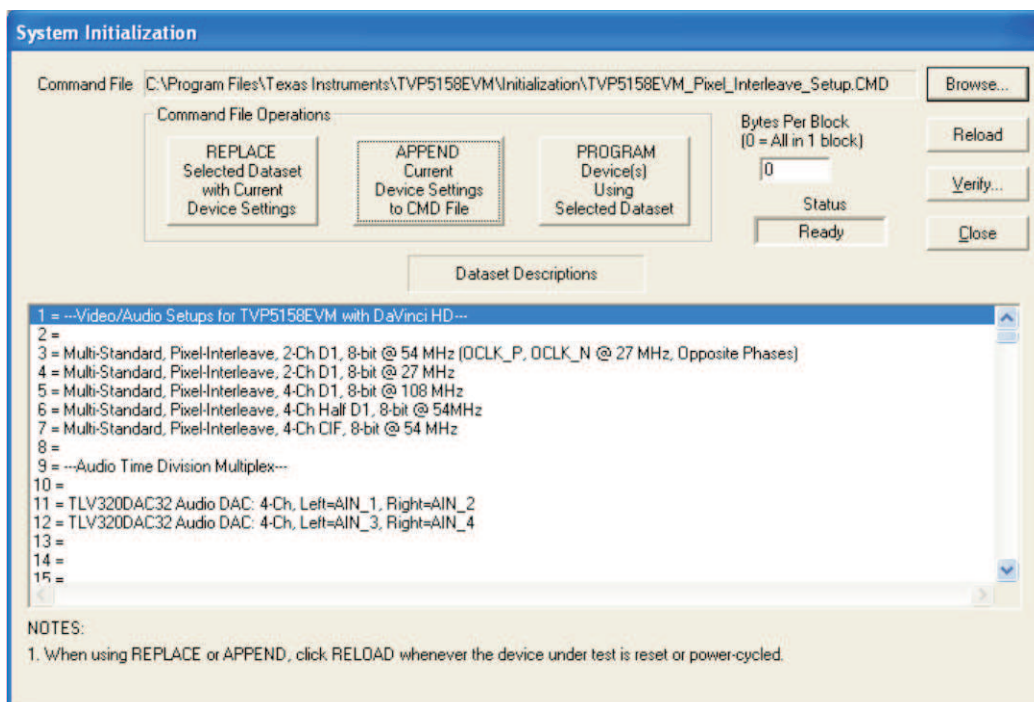

Figure 17. System Initialization for Pixel Interleave Modes

8 VCC Software in Depth

8.1 VCC Main Window

The VCC main window contains the menu bar whose contents are summarized in [Table 8](#).

Table 8. VCC Main Menu Summary

Menu	Contents
File	Exit
Edit	Register Map – Edit I2C registers directly TVP5158 THS8200 Generic I2C – Edit I2C registers for any slave address Property Sheets – GUI controls for the I2C register map TVP5158 THS8200
Tools	System Initialization – Initializes system using .CMD files Real-time Polling – Enables update of THS8200 when a video standard change occurs USB/LPT/I2C Options – Set 100 or 400 kHz I2C
Window	Allows selection of the active window
Help	Displays program version

8.2 Register Map Editor

The register map editor (see [Figure 18](#)) allows the display and editing of the entire used register space of the TVP5158 within a simple scrolling text box. To open this, click on the following menu item:

Edit > Register Map > TVP5158

[Table 9](#) describes how to use each of the controls in the register map editor.

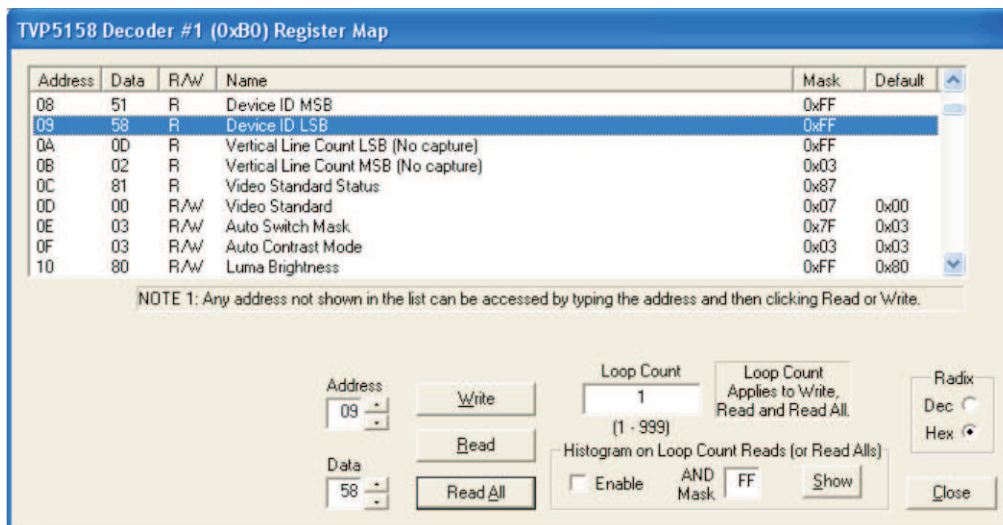

NOTE: To save registers to a file, check the Histogram Enable checkbox and click Read All. Click Show to view the saved file.

Figure 18. TVP5158 Register Map Editor

Table 9. VCC Register Map Editor Controls

Control	Definition
Register Window	Scrolling text box that displays the address and data for the I2C registers that are defined for the device.
Address Edit Box	This contains the I2C subaddress that will be accessed using the Write and Read buttons. Clicking on a row selects an address, which then appears in the address edit box. NOTE: After clicking on a row, the Data Edit box contains the data that was in the register window. The device has not yet been read. The address up/down arrows are used to jump to the next/previous subaddress that is defined for the device. If an address is not defined for the device, then it can still be accessed by typing the subaddress in the Address Edit box.
Data Edit Box	This contains the data which will be written to or was read from the I2C subaddress. The data up/down arrows increment/decrement the data value by 1.
Write Button	Writes the byte in the Data Edit box to the address in the Address Edit box. The I2C register is written to whether or not the data is different from the last time the register was read.
Read Button	Reads the data from the address in the Address Edit box into the Data Edit box and the register window.
Read All Button	Reads all defined readable registers from the device and updates the register window.
Hex Button	Converts all values in the register window and address and data edit boxes to hexadecimal.
Dec Button	Converts all values in the register window and address and data edit boxes to decimal.
Close Button	Closes the dialog. NOTE: Multiple edit register map windows can be open at the same time (one for each device). Use the Window menu to navigate.
Loop Count	Causes subsequent write, read or read all operations to be performed N times. N is entered as a decimal number from 1 to 999.

8.3 Property Sheets

The property sheets represent the register data in a user-friendly format. The data is organized by function, with each function having its own page and being selectable via tabs at the top.

To open this for the TVP5158, click on the following menu item:

Edit > Property Sheets > TVP5158

When the property sheet function is started or whenever you tab to a different page, all readable registers in the device are read from hardware to initialize the dialog pages. Values on the page are changed by manipulating the various dialog controls as described in [Table 11](#).

Table 10. Property Sheet Controls

Type of Control	Function/How to Set a Value	When is Hardware Updated?
Read-Only Edit Box	Read status information	N/A
Check Box	Toggle a single bit	After Apply
Drop-Down List	Select from a text list	After Apply
Edit Box	Type a number	After Apply
Edit Box with Up/Down Arrows	Use up/down arrows or type a number	Up/Down Arrows: Immediately Type a number: After Apply
Slider	Slide a lever	Immediately
Pushbutton	Initiate an action	Immediately

Table 11. Property Sheet Button Controls

Button	Definition
OK	Writes to all writeable registers whose data has changed. A register is flagged as changed if the value to be written is different from the value last read from that address. Closes the dialog.
Cancel	Causes all changes made to the property page since the last Apply to be discarded. Changes made to dialog controls with 'immediate hardware update' are not discarded, because they have already been changed in hardware. Does not write to hardware. Closes the dialog.
Apply	Writes to all writeable registers whose data has changed. A register is flagged as changed if the value to be written is different from the value last read from that address. Does not close the dialog.

8.3.1 Property Sheet Refresh

The property sheets were designed so that the data displayed is always current. Certain actions cause the entire register map to be read from the device and to update the property sheets. This happens when:

- Property sheets are initially opened.
- When tabbing from one page to another.
- When Read All is clicked.
- When making the Property Sheets window the active window (by clicking on it).
- When making a Register Map Editor window the active window (by clicking on it).

8.4 Video Decoder Select and Write Enables

The VCC main window contains controls for accessing the four video decoders within the TVP5158. The buttons under “Selected Video Decoder Core” are mutually exclusive. Four sets of the various editing tools (Register Map Edit and Property Sheets) exist in memory, but only the data for the selected video decoder can be seen. Any or all of the write enable buttons can be enabled. These control which of the video decoders will accept I2C writes.

8.4.1 Broadcast Write Access

This is the default configuration as shown in [Figure 19](#). All four decoders are enabled for I2C writes. All I2C writes done using the Edit Register Map, Property Sheets, or System Initialization tools will affect all video decoders.

8.4.2 Single Video Decoder Write Access

This configuration is used to program unique settings for one video decoder without effecting the others. The “Set write enable for selected decoder only” check box should be checked as shown in [Figure 20](#). This provides a shortcut, so that as each decoder is selected using the decoder buttons, the same decoder is also enabled for writes (and the other three are disabled for writes).

8.4.3 Arbitrary Video Decoder Write Access

This configuration is used to program the write enabled video decoder(s) in any combination. The “Set write enable for selected decoder only” check box should be unchecked.

NOTE: The command files used by the System Initialization tool can override the write enable button settings. They are generally setup for writing to all decoders independent of the current write enable buttons setting.

8.4.4 Editing Tools vs Video Decoder Write Enables

The behavior of the System Initialization, Edit Register Map and Property Sheets tools regarding the decoder write enables is described in [Table 12](#).

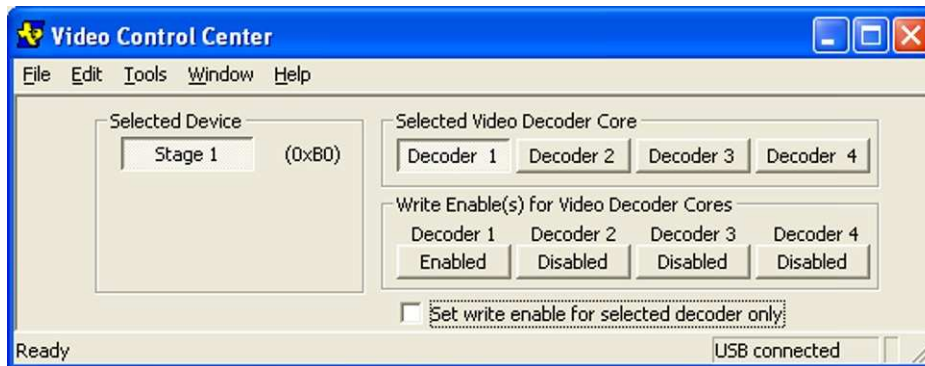

Figure 19. VCC Main Window – Configured for Broadcast Write Access (default)

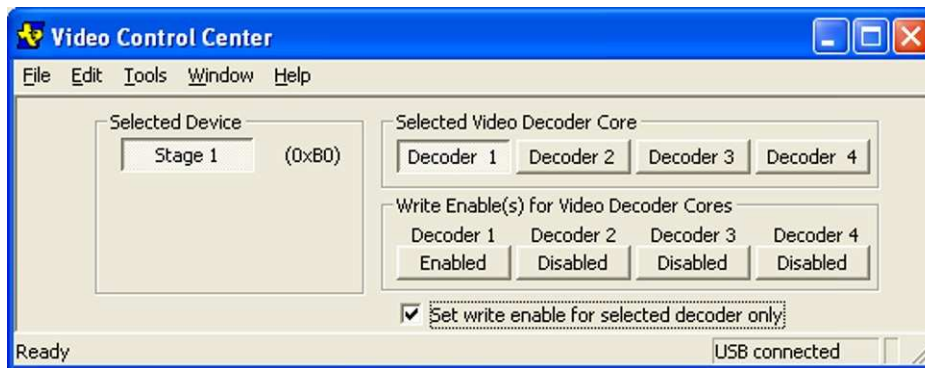

Figure 20. VCC Main Window – Configured for Single Video Decoder Write Access

Table 12. Editing Tools vs Video Decoder Write Enables

Editing Tool	Reads From	Writes To	Writes What
Command File	N/A	Write Enabled decoders (can be overridden in cmd file)	I2C register values
Edit Register Map	Selected Decoder	Write Enabled decoders	1 byte – same data to all
Edit Property Sheets	Selected Decoder	Write Enabled decoders	Bit fields that changed on the selected decoder

8.5 Example TVP5158 Property Pages

Example property pages are shown in [Figure 21](#) through [Figure 24](#).

Some of the controls for the Output Formatter (OFM) page only exist for video decoder 1. [Figure 21](#) shows the OFM page when Decoder 1 is the selected decoder. [Figure 22](#) shows the OFM page when Decoder 4 is the selected decoder (some of the OFM controls are not visible). They would also not be visible for Decoder 2 and Decoder 3. To change the Port A selection, for example, Decoder 1 must be the selected decoder.

The Audio property page only exists for video decoder 1. To access the Audio controls Decoder 1 must be the selected decoder.

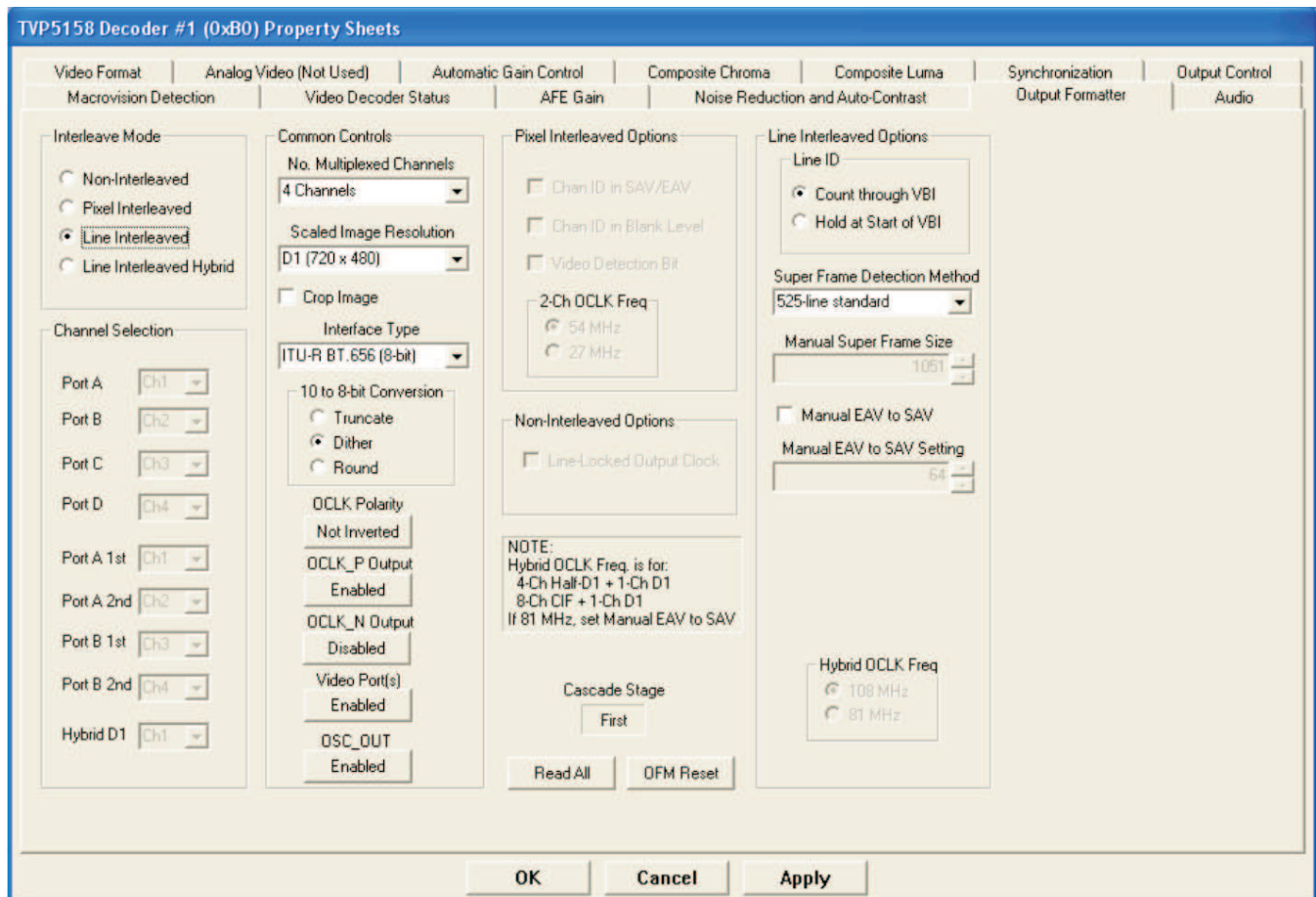

Figure 21. TVP5158 Output Formatter Property Page With Decoder 1 Selected

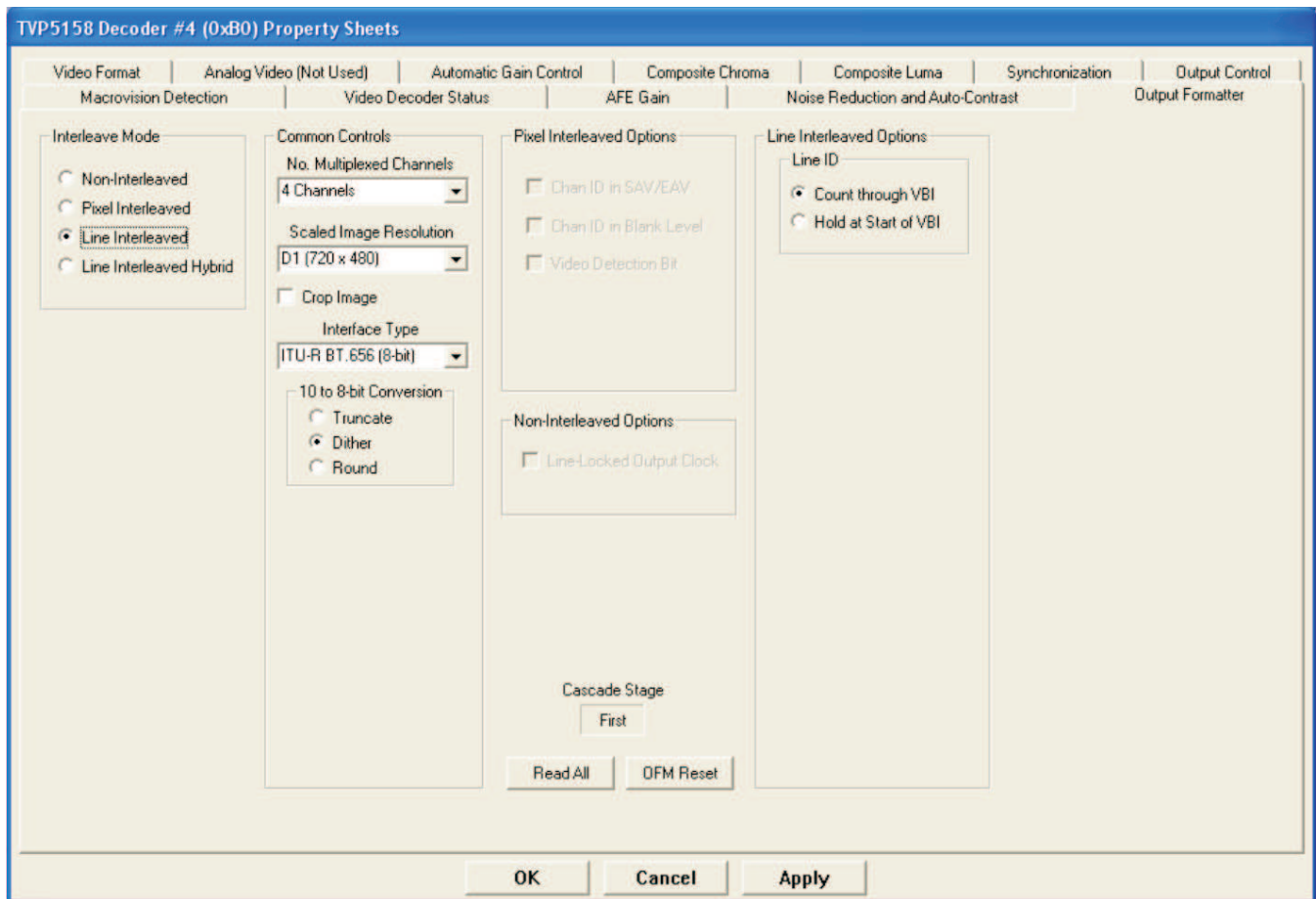

Figure 22. TVP5158 Output Formatter Property Page With Decoder 4 Selected

TVP5158 Decoder #4 (0x80) Property Sheets

Video Format	Analog Video (Not Used)	Automatic Gain Control	Composite Chroma	Composite Luma	Synchronization	Output Control
Macrovision Detection	Video Decoder Status	AFE Gain	Noise Reduction and Auto-Contrast		Output Formatter	

Noise Reduction Control

On
 Off
 Bypass (Test Mode)

Y Block Width
 256
 512

UV Block Width
 128
 256

Field Noise Filter

Filter Beta:
 Y TO Factor:
 U TO Factor:
 V TO Factor:

Max Noise:

Weak Signal Low Threshold:
 Weak Signal High Threshold:
(0 to 255) (0 to 255)

NR Status

Noise Limit Exceeded: Y U V

Noise Measurement:

0 65535

Auto-Contrast Control

Enabled
 Disabled
 User Mode

User Table Index:

Figure 23. TVP5158 Noise Reduction and Auto Contrast Property Page

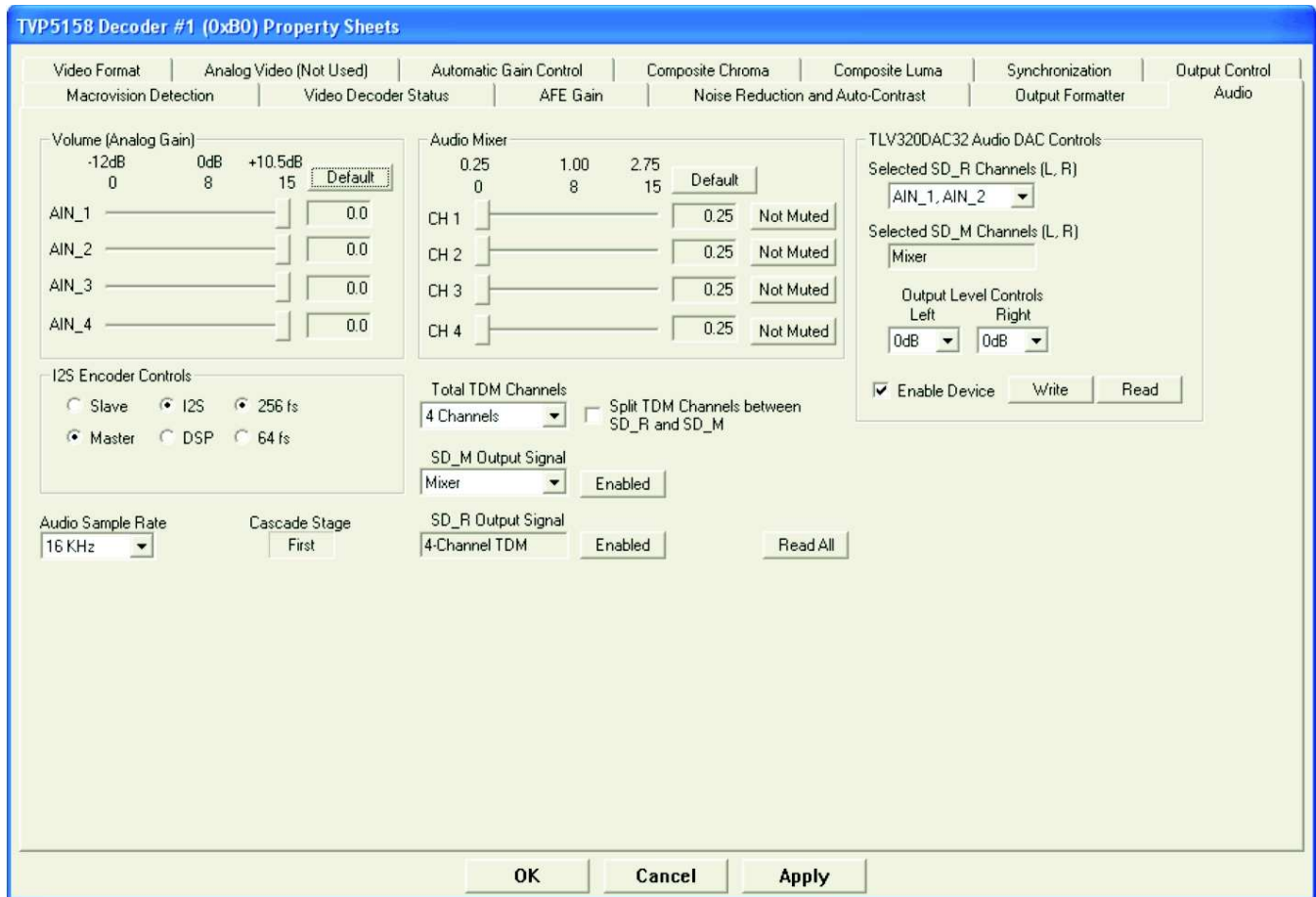

Figure 24. TVP5158 Audio Property Page (Seen Only When Decoder 1 is Selected)

Figure 25 shows how TDM I2S audio data can be configured. Jumper W9 can be used to select the SD_R (default) or SD_M I2S output to the audio DAC.

I ² S																		
		LRCLK_RLeft									LRCLK_RRight							
tdm_ch	tdm_out_pin		Slot1	Slot2	Slot3	Slot4	Slot5	Slot6	Slot7	Slot8	Slot9	Slot10	Slot11	Slot12	Slot13	Slot14	Slot15	Slot16
0 (2 channel)	0	SD_R	AIN_1								AIN_2							
		SD_M																
0 (2 channel)	1	SD_R	AIN_1															
		SD_M	AIN_2															
1 (4 channel)	0	SD_R	AIN_1	AIN_3							AIN_2	AIN_4						
		SD_M																
1 (4 channel)	1	SD_R	AIN_1								AIN_2							
		SD_M	AIN_3								AIN_4							
2 (8 channel)	0	SD_R	AIN_1	AIN_3	AIN_5	AIN_7					AIN_2	AIN_4	AIN_6	AIN_8				
		SD_M																
2 (8 channel)	1	SD_R	AIN_1	AIN_5							AIN_2	AIN_6						
		SD_M	AIN_3	AIN_7							AIN_4	AIN_8						
3 (12 channel)	0	SD_R	AIN_1	AIN_3	AIN_5	AIN_7	AIN_9	AIN_11			AIN_2	AIN_4	AIN_6	AIN_8	AIN_10	AIN_12		
		SD_M																
3 (12 channel)	1	SD_R	AIN_1	AIN_5	AIN_9						AIN_2	AIN_6	AIN_10					
		SD_M	AIN_3	AIN_7	AIN_11						AIN_4	AIN_8	AIN_12					
4 (16channel)	0	SD_R	AIN_1	AIN_3	AIN_5	AIN_7	AIN_9	AIN_11	AIN_13	AIN_15	AIN_2	AIN_4	AIN_6	AIN_8	AIN_10	AIN_12	AIN_14	AIN_16
		SD_M																
4 (16channel)	1	SD_R	AIN_1	AIN_5	AIN_9	AIN_13					AIN_2	AIN_6	AIN_10	AIN_14				
		SD_M	AIN_3	AIN_7	AIN_11	AIN_15					AIN_4	AIN_8	AIN_12	AIN_16				

DSP Format																		
tdm_ch	tdm_out_pin		Slot1	Slot2	Slot3	Slot4	Slot5	Slot6	Slot7	Slot8	Slot9	Slot10	Slot11	Slot12	Slot13	Slot14	Slot15	Slot16
0 (2 channel)	0	SD_R	AIN_1	AIN_2														
		SD_M																
0 (2 channel)	1	SD_R	AIN_1															
		SD_M	AIN_2															
1 (4 channel)	0	SD_R	AIN_1	AIN_3	AIN_2	AIN_4												
		SD_M																
1 (4 channel)	1	SD_R	AIN_1	AIN_2														
		SD_M	AIN_3	AIN_4														
2 (8 channel)	0	SD_R	AIN_1	AIN_3	AIN_5	AIN_7	AIN_2	AIN_4	AIN_6	AIN_8								
		SD_M																
2 (8 channel)	1	SD_R	AIN_1	AIN_5	AIN_2	AIN_6												
		SD_M	AIN_3	AIN_7	AIN_4	AIN_8												
3 (12 channel)	0	SD_R	AIN_1	AIN_3	AIN_5	AIN_7	AIN_9	AIN_11	AIN_2	AIN_4	AIN_6	AIN_8	AIN_10	AIN_12				
		SD_M																
3 (12 channel)	1	SD_R	AIN_1	AIN_5	AIN_9	AIN_2	AIN_6	AIN_10										
		SD_M	AIN_3	AIN_7	AIN_11	AIN_4	AIN_8	AIN_12										
4 (16channel)	0	SD_R	AIN_1	AIN_3	AIN_5	AIN_7	AIN_9	AIN_11	AIN_13	AIN_15	AIN_2	AIN_4	AIN_6	AIN_8	AIN_10	AIN_12	AIN_14	AIN_16
		SD_M																
4 (16channel)	1	SD_R	AIN_1	AIN_5	AIN_9	AIN_13	AIN_2	AIN_6	AIN_10	AIN_14								
		SD_M	AIN_3	AIN_7	AIN_11	AIN_15	AIN_4	AIN_8	AIN_12	AIN_16								

Figure 25. TDM I2S Audio Data Configuration

9 Troubleshooting

This section discusses ways to troubleshoot the TVP5158EVM.

9.1 Troubleshooting Guide

If you are experiencing problems with the TVP5158EVM hardware or the VCC software, see [Table 13](#) through [Table 16](#) for available solutions.

Table 13. Troubleshooting Setup and General Issues

Symptom	Cause	Solution
TVP5158EVM Software Installer reports that previous version must be uninstalled	Previous version was installed	Use "Add or Remove Programs" in Windows Control Panel to remove previous version of TVP5158EVM Software. Run SETUP.EXE again.
On connecting USB cable, green "connected LED" does not light.	EVM was not recognized on the USB.	Disconnect USB cable between PC and EVM. Wait 3 seconds. Reconnect the USB cable. Green "connected LED" near USB connector should light.
On connecting USB cable, New Hardware Wizard appears	Jumper W6 has been removed.	Install jumper W6 near USB connector. Disconnect USB cable between PC and EVM. Wait 3 seconds. Reconnect the USB cable. Green "connected LED" should light.
VCC application has slow response time.	USB polling rate is too slow.	Connect EVM directly to a laptop/desktop USB port instead going through a docking station. Property Pages can not be refreshed using Read All buttons at more than about a 1-Hz rate.
Nothing seems to happen when I click Read All repeatedly.	Clicking Read All button too frequently.	Property Pages can not be refreshed using Read All buttons at more than about a 1-Hz rate.

Table 14. Troubleshooting with THS8200 and CompositeVideo Output

Symptom	Cause	Solution
USB: Device Not Found error message	EVM was not recognized on the USB.	Disconnect USB cable. Wait 3 seconds. Reconnect USB cable. Green "connected LED" should light. Click continue
USB: I2C Error Code 1 error message. An I2C acknowledge error has occurred. See reported I2C slave address and sub-address.	5V power not present	Connect 5V power supply to EVM. Click Continue.
	EVM hardware reset button has been pressed.	Normal occurrence. An I2C error will occur if the hardware reset button is pressed while real-time polling or property page auto-update is active. Click Continue.
	I2C slave address jumper setting and program setting do not match.	Check that jumpers W2, W1 and W0 are connected across pins 1-2 (L, L, L) to specify slave address 0xB0 (Set jumper W0 across pins 2-3 (L, L, H) to specify slave address 0xB2 for a cascaded 2nd TVP5158EVM.) Exit VCC application. Restart VCC and select the correct I2C slave address.
	I2C bus master jumpered incorrectly.	Check that jumpers W3 and W4 are connected across pins 1-2 to select USB as I2C master.
No video output	Wrong video input is selected.	Click on System Initialization in the Tools menu. Browse to TVP5158EVM_YPbPr_Output_Setup.CMD. Click on the dataset named "Select Ch-X Video Input". (X is the channel to be displayed.) Click the program button.
	TVP5158 is not locked to video signal.	Click on Property Sheets -> TVP5158 in the Edit menu (see Figure 26). Lock status LEDs should both be green. In main window, click buttons Decoder1, ..., Decoder4 to see the lock status of each decoder (see Figure 3). for numbering of video inputs.
	THS8200 is not receiving BT.656 data correctly.	Click on Property Sheets -> THS8200 in the Edit menu. Pixel count/line count status should be 858/525 for NTSC or 864/625 for PAL (see Figure 27).
	THS8200 programmed for wrong standard.	Click on Property Sheets -> THS8200 in the Edit menu. Click DTG tab. Frame Size should be set to 525 if source is NTSC or 625 if source is PAL. If not, click Real-time polling button in the Tools menu.
Horizontal instability in displayed image	THS8200 Video Triple DAC requires a line-locked clock.	On TVP5158 Output Formatter property page, check the Line-Locked Output Clock check box. Set the Port A Channel Selection drop-down box to select the video input for display. Line-Locked Output Clock is required when using non-interleaved mode and THS8200.

Table 14. Troubleshooting with THS8200 and CompositeVideo Output (continued)

Symptom	Cause	Solution
No audio	Wrong digital audio output selected.	Set jumper W9 across pins 2-3 to hear the record output (SD_R) or across 1-2 to hear the mixer output (SD_M).

Table 15. Troubleshooting with DM6467 DaVinci HD EVM

Symptom	Cause	Solution
No serial communication	Wrong serial port settings	Set terminal program to 115200 baud, 8 bit data, no parity, 1 stop bit. Check that COM port is available in the Windows Device Manager and is not being used by another program.
	Wrong cable type	Use a null MODEM 9-pin serial cable. Pins 2 and 3 at one end should be wired to pins 3 and 2 at the other end.
Boot up process fails	No wired network connection	Connect Ethernet LAN cable to DaVinci HD EVM
	No FTP server available	Boot up arguments must specify the IP address of the computer that contains the image file to be loaded. An FTP server program must be running on that computer.
	No Linux host available	A PC running the Linux O/S or a PC running the Windows O/S with a virtual Linux O/S must be accessible on the LAN and provide a shared file system for the boot process.

Table 16. Troubleshooting I2C Connections and Cascaded EVMs

Symptom	Cause	Solution
When PC USB (VCC application) is I2C master for TVP5158		
USB: I2C Error Code 1 error message.	I2C bus master jumpered incorrectly.	Check that jumpers W3 and W4 are connected across pins 1-2 to select USB as I2C master.
When DSP video/audio driver is I2C master for TVP5158		
I2C error messages from demo application.	I2C bus master jumpered incorrectly.	Check that jumpers W3 and W4 are connected across pins 2-3 to select DaVinci HD EVM as I2C master.
When cascading two TVP5158EVMs together		
I2C error messages from demo application.	I2C bus master jumpered incorrectly.	<p>The Stage 2 TVP5158EVM feeds cascaded video and audio data through connector J2 to connector J3 of the Stage 1 TVP5158EVM.</p> <p>On the Stage 2 board, check that jumpers W2, W1, and W0 are connected across pins 1-2, 1-2 and 2-3 (L, L, H) respectively, to specify slave address 0xB2.</p> <p>On the Stage 2 board, check that jumpers W3 and W4 are both removed to allow I2C to be mastered by the stage 1 board.</p> <p>Also on the Stage 2 board, remove W7 and W8 to remove the second Audio DAC from the I2C bus.</p> <p>The Stage 1 TVP5158EVM can have I2C controlled by USB or the DaVinci HD EVM.</p> <p>Any changes to the above setup require that VCC be exited and restarted so that the correct I2C slave address(es) can be selected.</p>

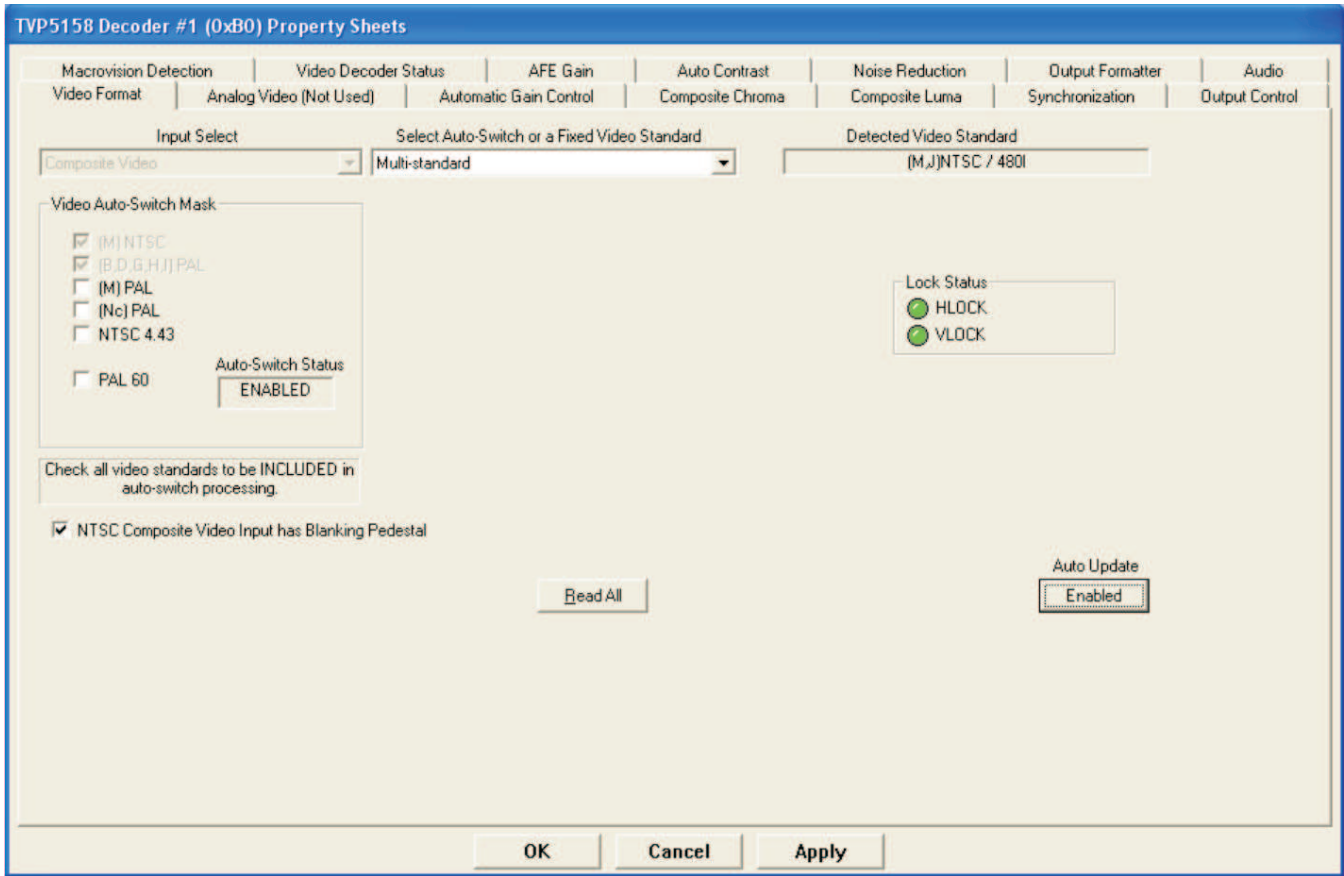

Figure 26. TVP5158 Video Format Property Page

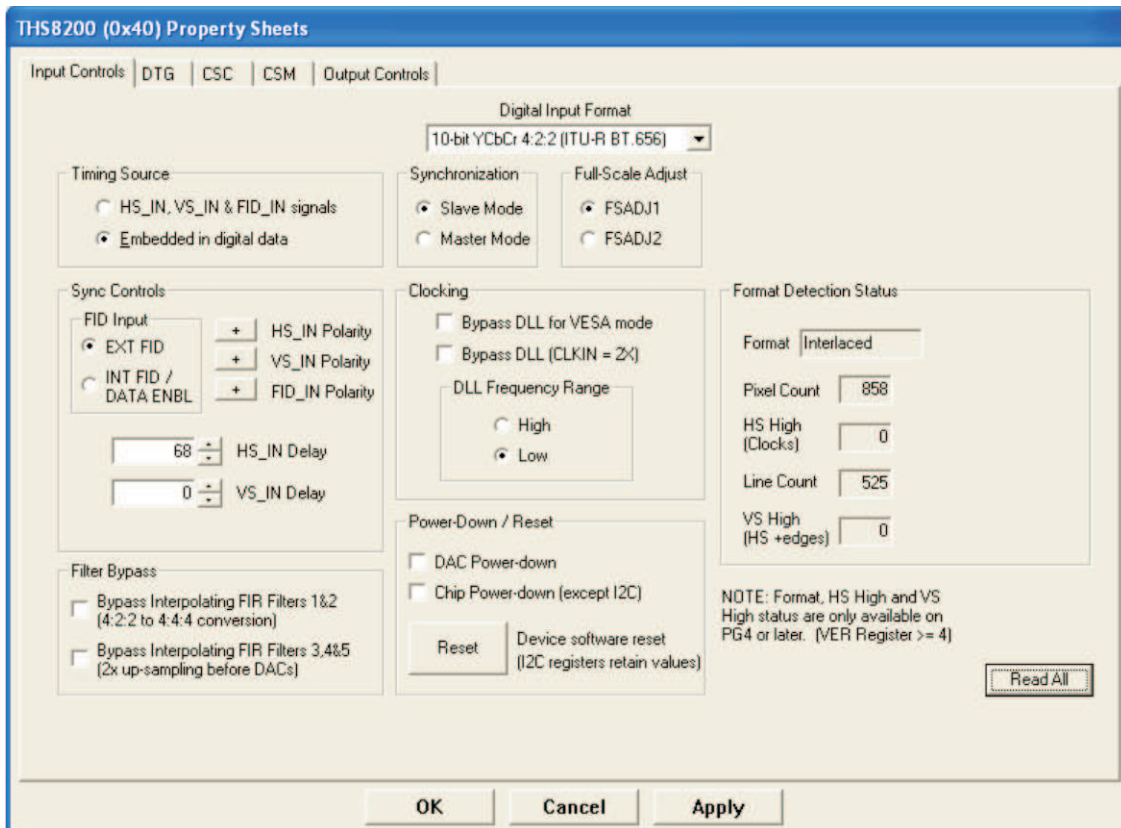

Figure 27. THS8200 Input Controls / Status Property Page

10 TVP5158 EVM Schematics

This section contains the TVP5158EVM schematics.

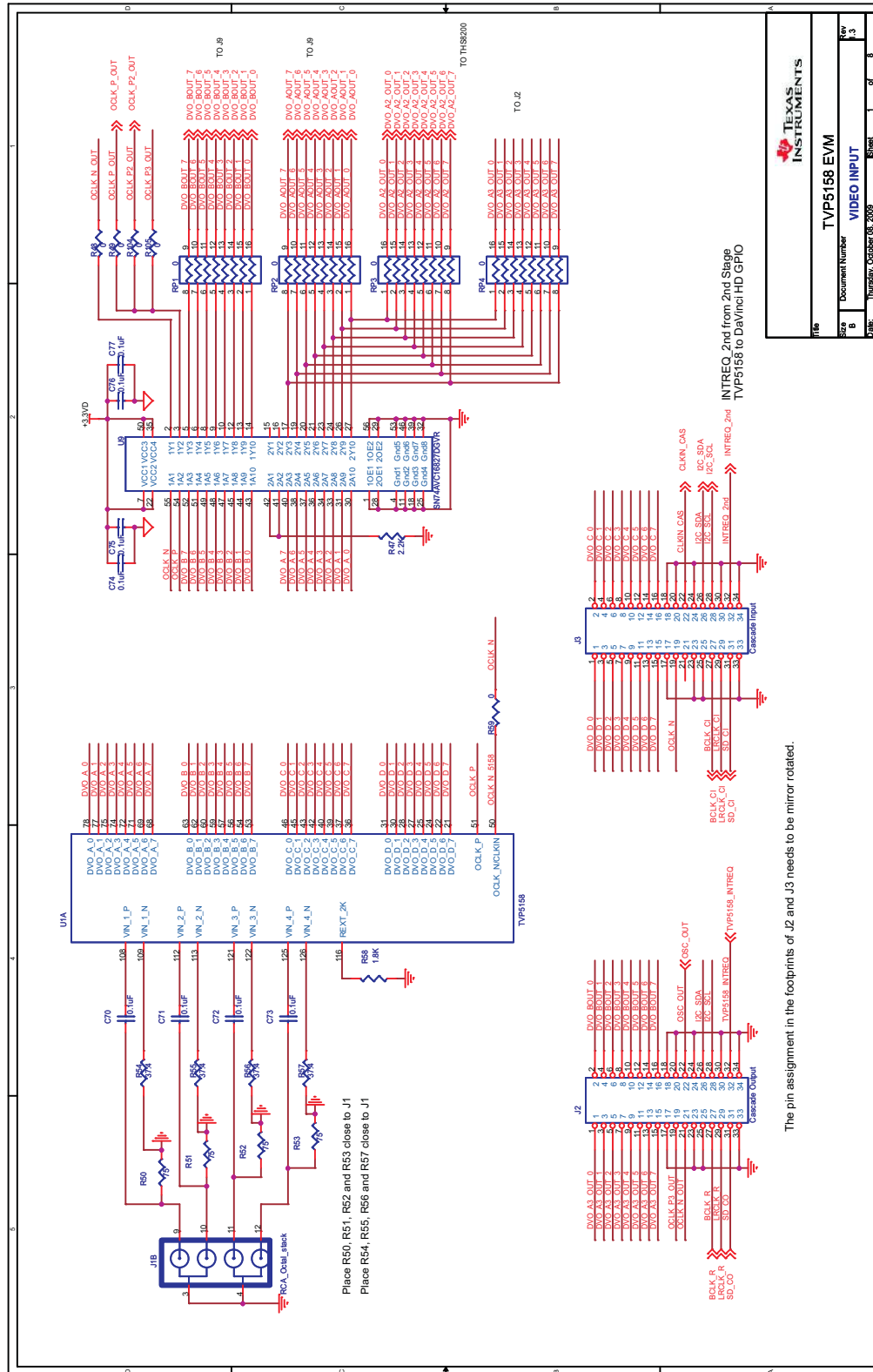
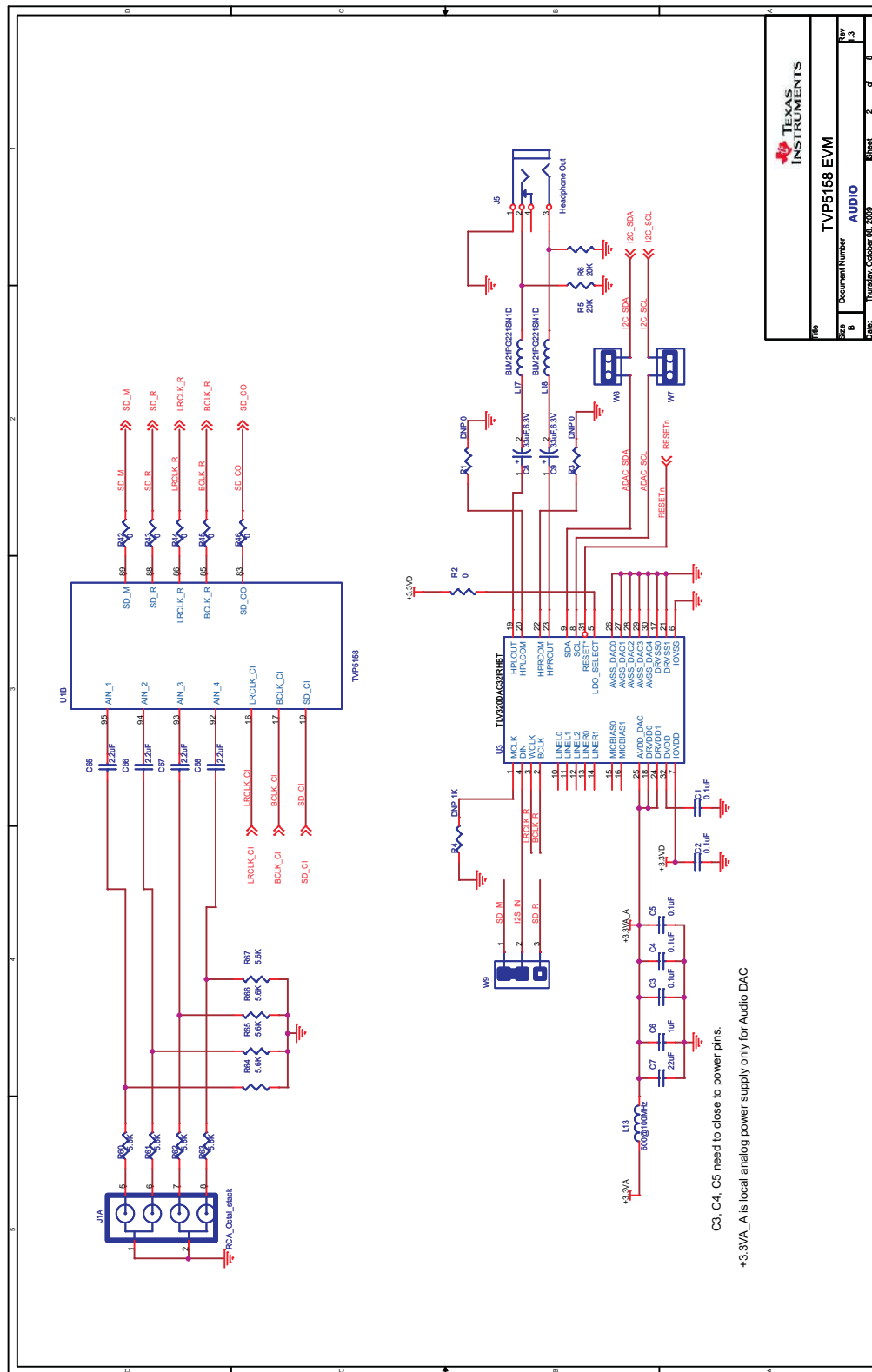
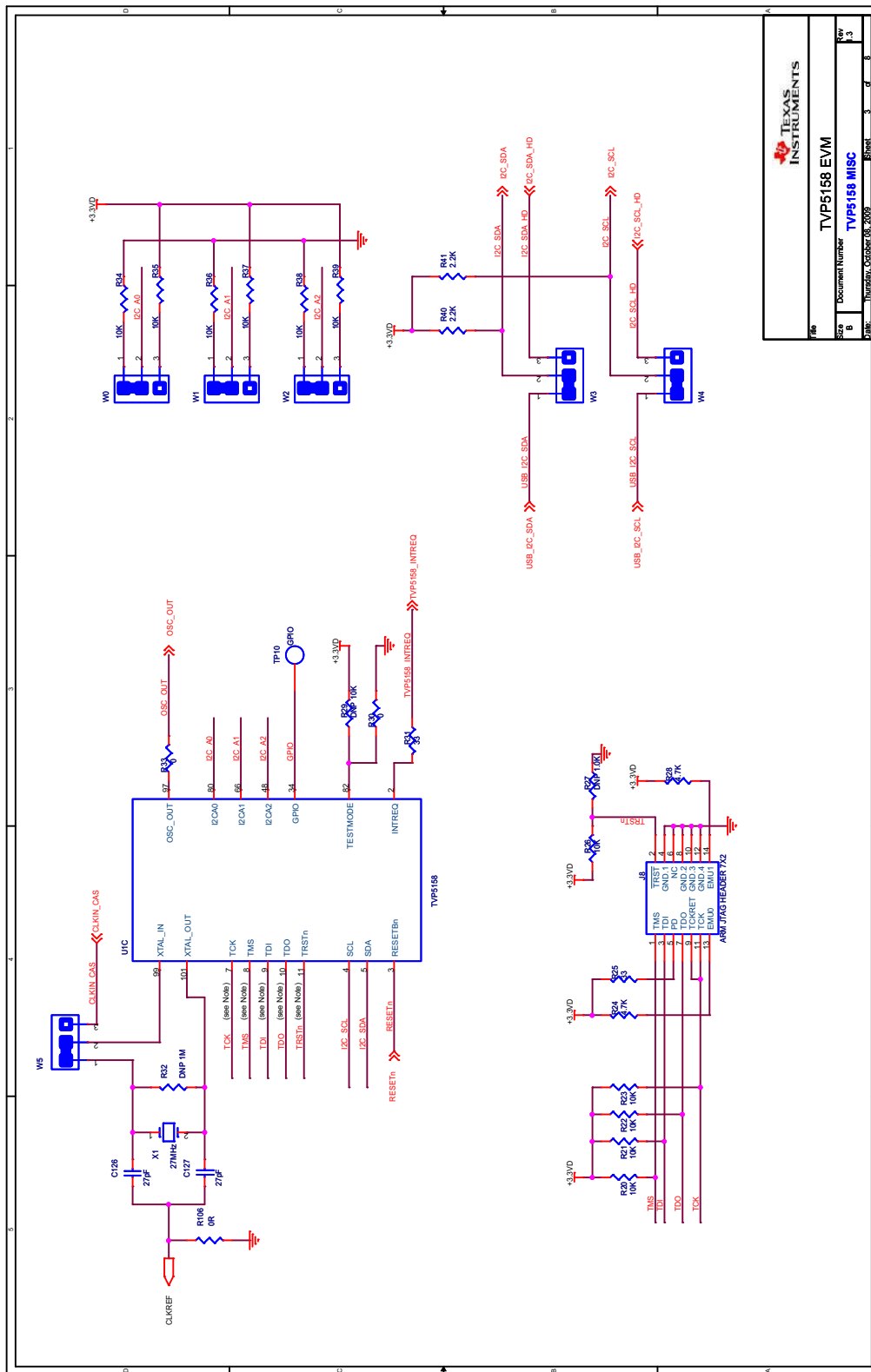

Figure 28. Schematics (1 of 8)



TEXAS INSTRUMENTS	
TVP5158 EVM	
Doc	Document Number
B	AUDIO
Rev	Revised
3	08/2009

Figure 29. Schematics (2 of 8)



TEXAS INSTRUMENTS	
TVP5158 EVM	
Document Number	TVP5158 MISC
Rev	3.3
Part Number	TVP5158
Release Date	October 2009

NOTE: Pins 7, 8, 9, 10, and 11 on the TVP5158 are reserved for JTAG connection and should be left floating in customer designs for correct device operation.

Figure 30. Schematics (3 of 8)

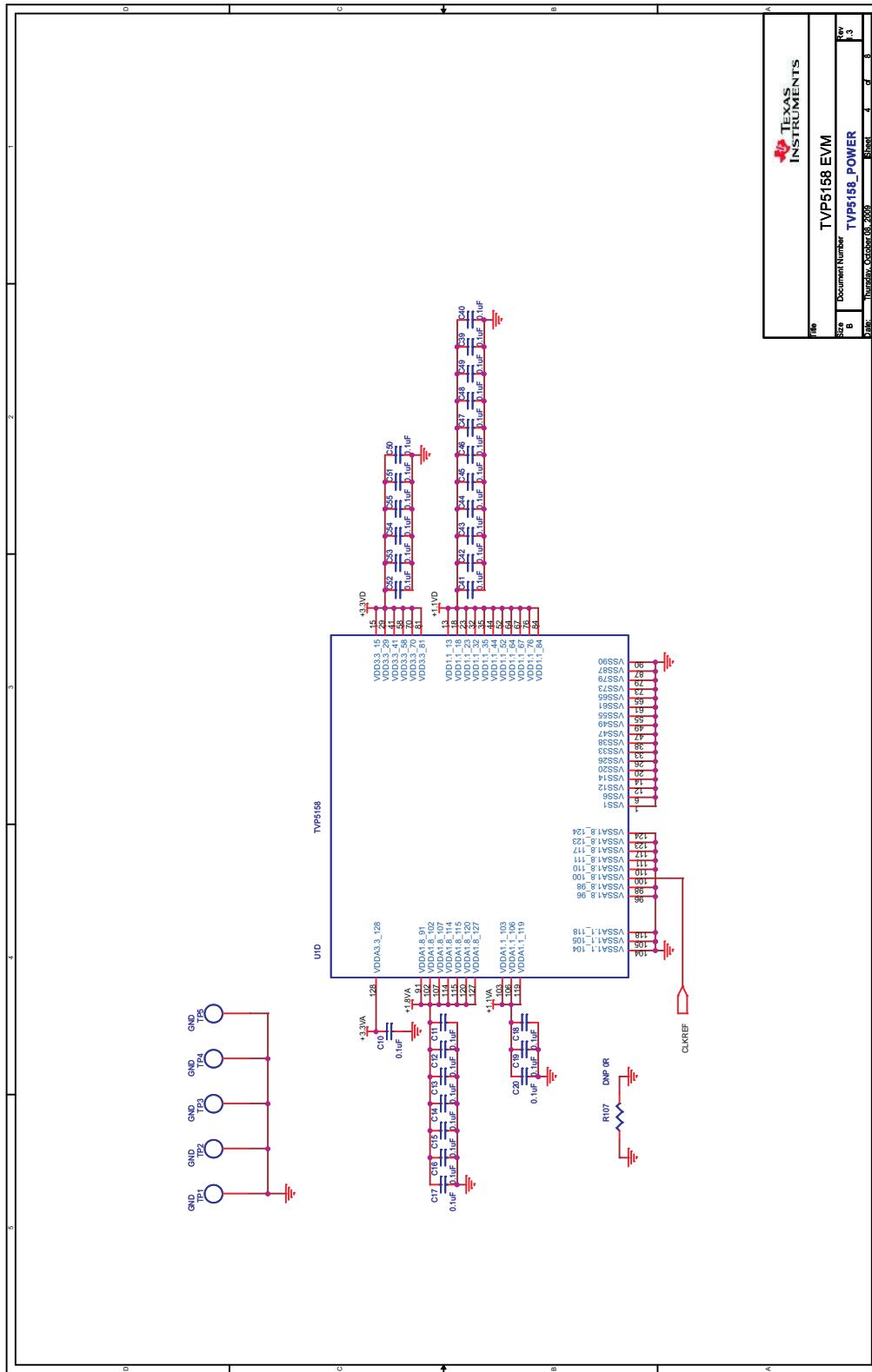

File	TEXAS INSTRUMENTS
Page	TVP5158 EVM
Docu- ment Number	TVP5158_POWER
Rev	3
Date	THURSDAY, OCTOBER 08, 2009
Sheet	4 of 8

Figure 31. Schematics (4 of 8)

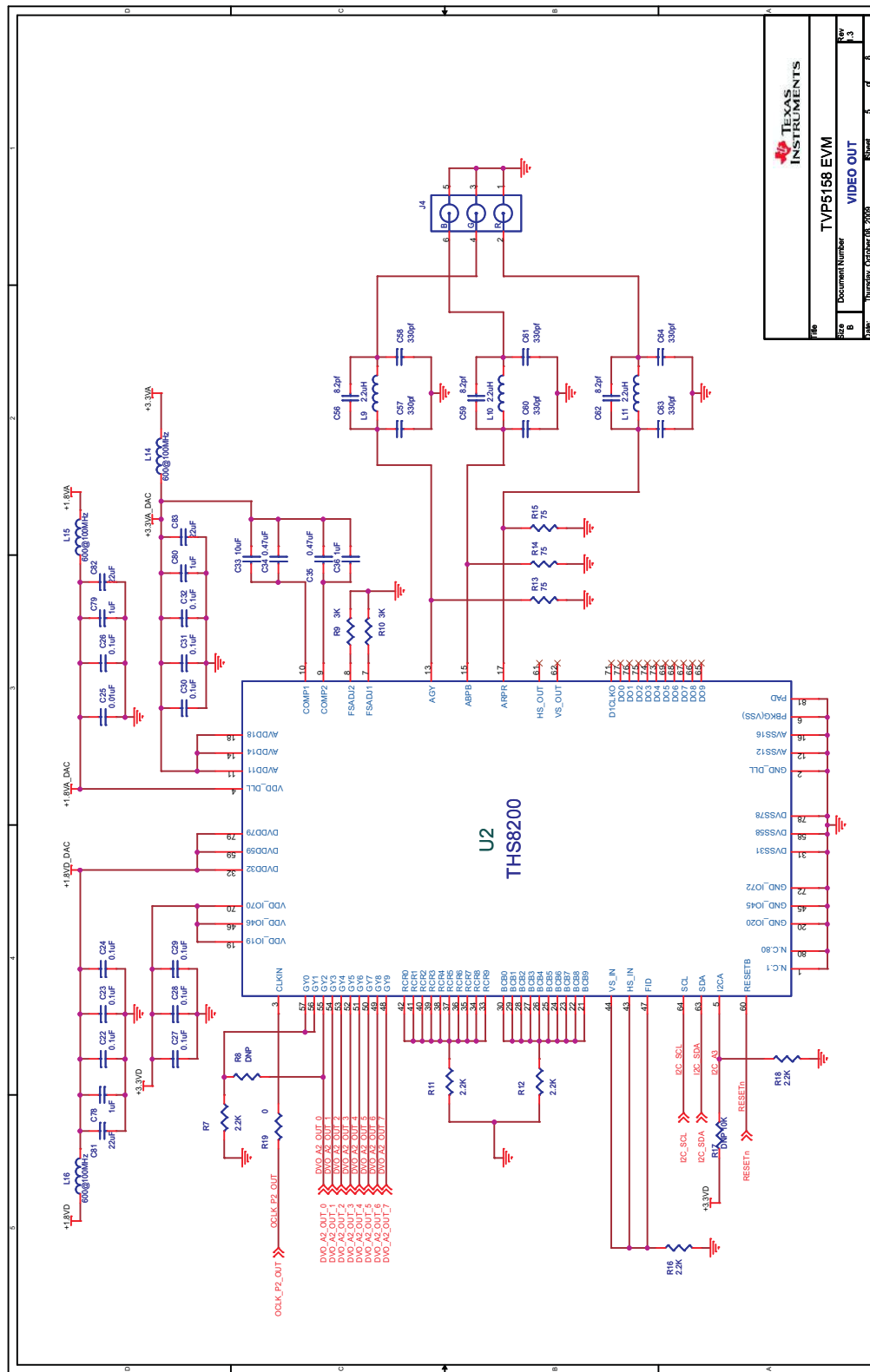

File	TEXAS INSTRUMENTS
Doc	TVP5158 EVM
Sheet	VIDEO OUT
Document Number	
Rev	3
Date	10/20/09

Figure 32. Schematics (5 of 8)

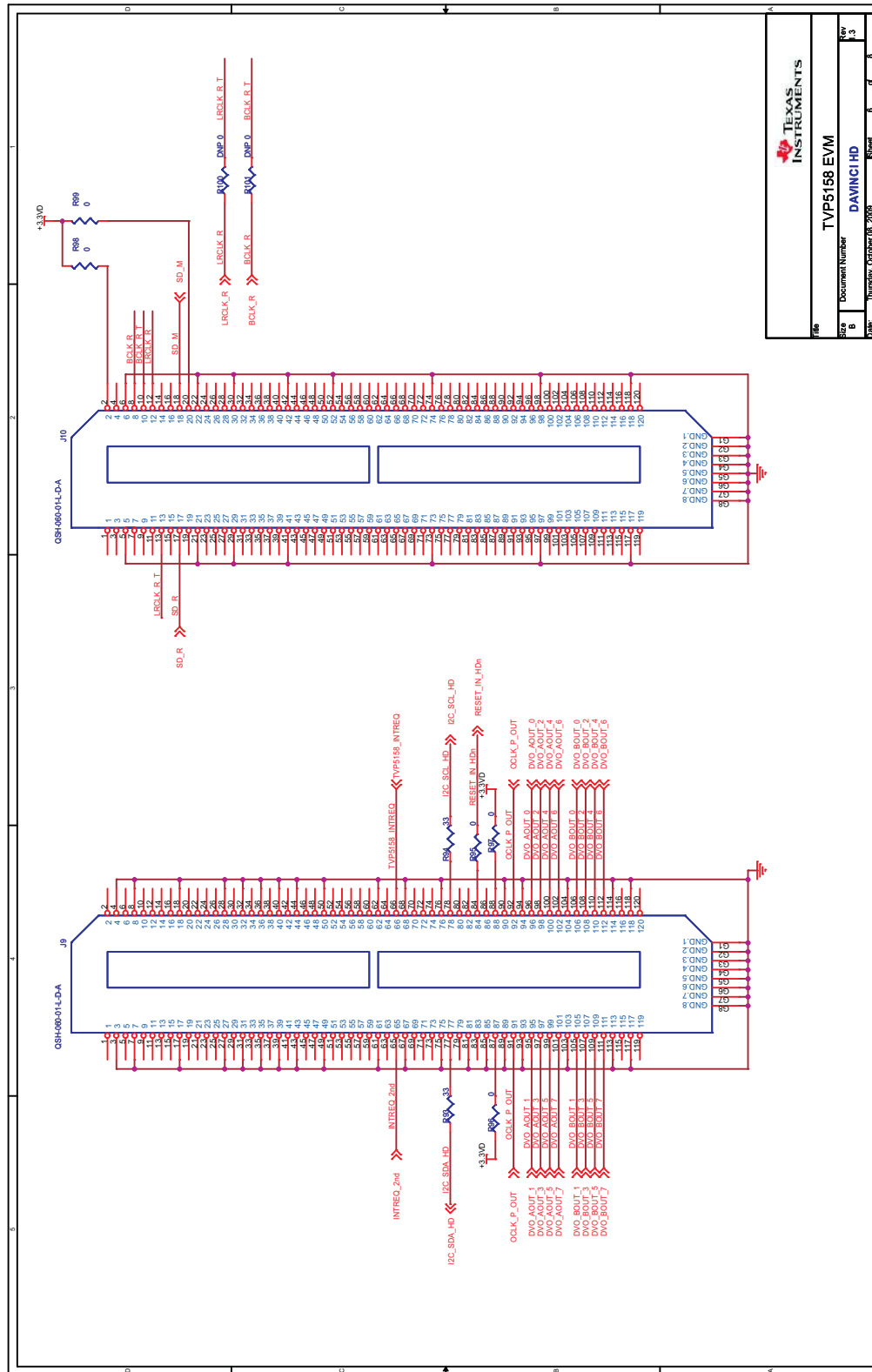
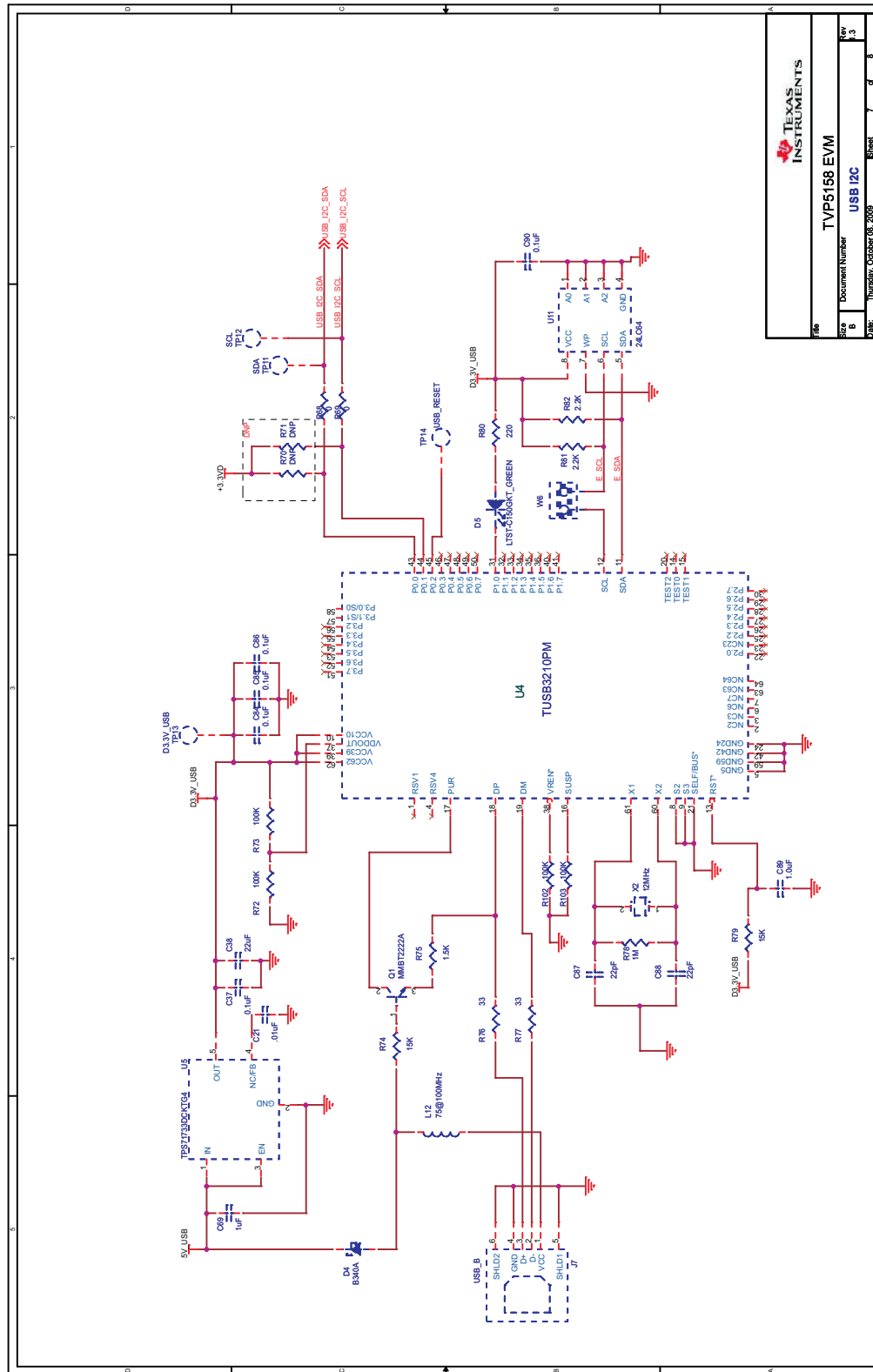

Figure 33. Schematics (6 of 8)



TEXAS INSTRUMENTS	
TVP5158 EVM	
Document Number	USB I2C
Rev	3
Part Number	TPV5158_020008.08_2009
Sheet	7 of 8

Figure 34. Schematics (7 of 8)

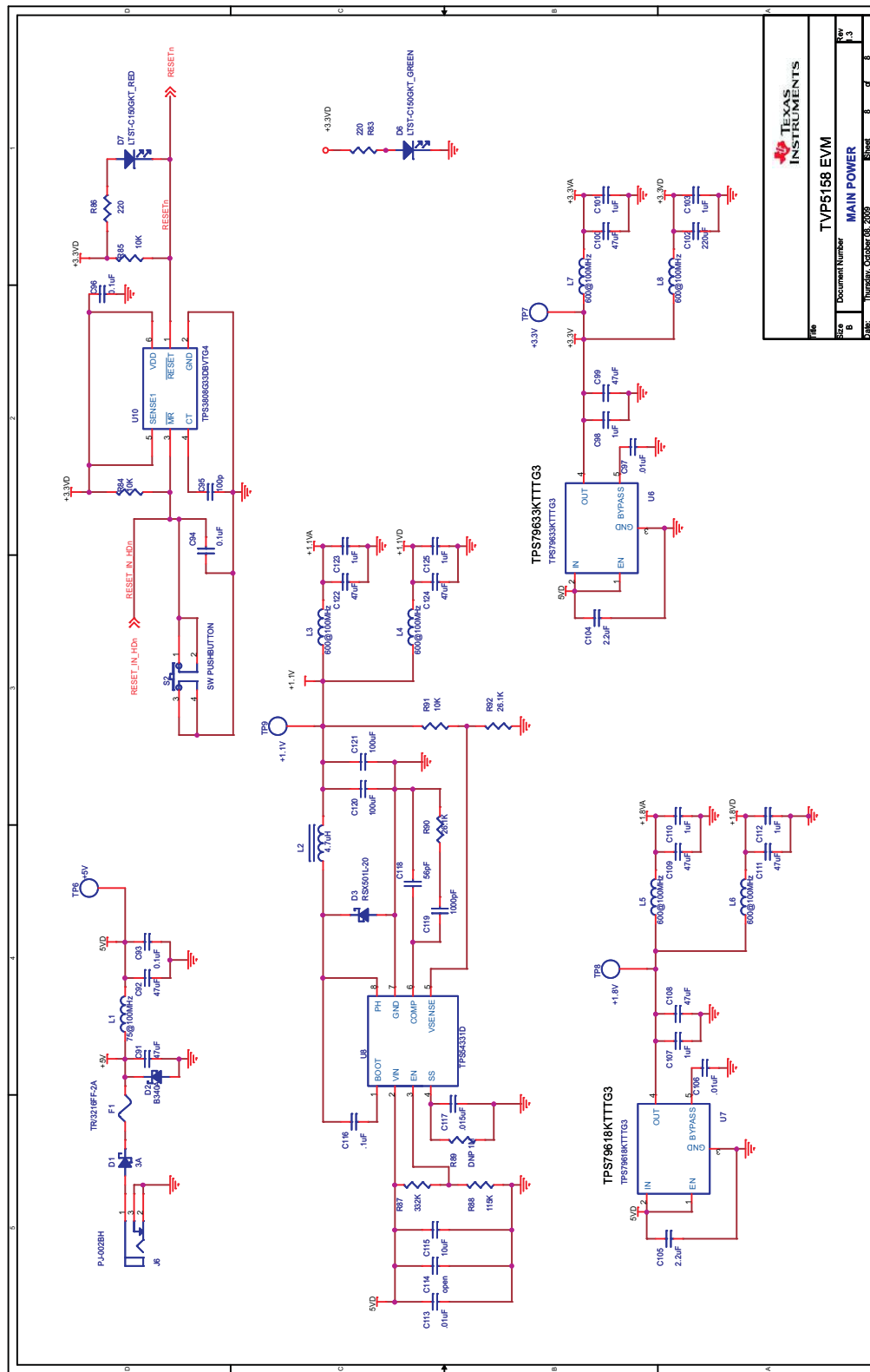

Figure 35. Schematics (8 of 8)

Revision History

Changes from Original (November 2009) to A Revision Page

- Added note to [Figure 30](#) 39
-

NOTE: Page numbers for previous revisions may differ from page numbers in the current version.

ADDITIONAL TERMS AND CONDITIONS, WARNINGS, RESTRICTIONS, AND DISCLAIMERS FOR EVALUATION MODULES

Texas Instruments Incorporated (TI) markets, sells, and loans all evaluation boards, kits, and/or modules (EVMs) pursuant to, and user expressly acknowledges, represents, and agrees, and takes sole responsibility and risk with respect to, the following:

1. User agrees and acknowledges that EVMs are intended to be handled and used for feasibility evaluation only in laboratory and/or development environments. Notwithstanding the foregoing, in certain instances, TI makes certain EVMs available to users that do not handle and use EVMs solely for feasibility evaluation only in laboratory and/or development environments, but may use EVMs in a hobbyist environment. All EVMs made available to hobbyist users are FCC certified, as applicable. Hobbyist users acknowledge, agree, and shall comply with all applicable terms, conditions, warnings, and restrictions in this document and are subject to the disclaimer and indemnity provisions included in this document.
2. Unless otherwise indicated, EVMs are not finished products and not intended for consumer use. EVMs are intended solely for use by technically qualified electronics experts who are familiar with the dangers and application risks associated with handling electrical mechanical components, systems, and subsystems.
3. User agrees that EVMs shall not be used as, or incorporated into, all or any part of a finished product.
4. User agrees and acknowledges that certain EVMs may not be designed or manufactured by TI.
5. User must read the user's guide and all other documentation accompanying EVMs, including without limitation any warning or restriction notices, prior to handling and/or using EVMs. Such notices contain important safety information related to, for example, temperatures and voltages. For additional information on TI's environmental and/or safety programs, please visit www.ti.com/esh or contact TI.
6. User assumes all responsibility, obligation, and any corresponding liability for proper and safe handling and use of EVMs.
7. Should any EVM not meet the specifications indicated in the user's guide or other documentation accompanying such EVM, the EVM may be returned to TI within 30 days from the date of delivery for a full refund. THE FOREGOING LIMITED WARRANTY IS THE EXCLUSIVE WARRANTY MADE BY TI TO USER AND IS IN LIEU OF ALL OTHER WARRANTIES, EXPRESSED, IMPLIED, OR STATUTORY, INCLUDING ANY WARRANTY OF MERCHANTABILITY OR FITNESS FOR ANY PARTICULAR PURPOSE. TI SHALL NOT BE LIABLE TO USER FOR ANY INDIRECT, SPECIAL, INCIDENTAL, OR CONSEQUENTIAL DAMAGES RELATED TO THE HANDLING OR USE OF ANY EVM.
8. No license is granted under any patent right or other intellectual property right of TI covering or relating to any machine, process, or combination in which EVMs might be or are used. TI currently deals with a variety of customers, and therefore TI's arrangement with the user is not exclusive. TI assumes no liability for applications assistance, customer product design, software performance, or infringement of patents or services with respect to the handling or use of EVMs.
9. User assumes sole responsibility to determine whether EVMs may be subject to any applicable federal, state, or local laws and regulatory requirements (including but not limited to U.S. Food and Drug Administration regulations, if applicable) related to its handling and use of EVMs and, if applicable, compliance in all respects with such laws and regulations.
10. User has sole responsibility to ensure the safety of any activities to be conducted by it and its employees, affiliates, contractors or designees, with respect to handling and using EVMs. Further, user is responsible to ensure that any interfaces (electronic and/or mechanical) between EVMs and any human body are designed with suitable isolation and means to safely limit accessible leakage currents to minimize the risk of electrical shock hazard.
11. User shall employ reasonable safeguards to ensure that user's use of EVMs will not result in any property damage, injury or death, even if EVMs should fail to perform as described or expected.
12. User shall be solely responsible for proper disposal and recycling of EVMs consistent with all applicable federal, state, and local requirements.

Certain Instructions. User shall operate EVMs within TI's recommended specifications and environmental considerations per the user's guide, accompanying documentation, and any other applicable requirements. Exceeding the specified ratings (including but not limited to input and output voltage, current, power, and environmental ranges) for EVMs may cause property damage, personal injury or death. If there are questions concerning these ratings, user should contact a TI field representative prior to connecting interface electronics including input power and intended loads. Any loads applied outside of the specified output range may result in unintended and/or inaccurate operation and/or possible permanent damage to the EVM and/or interface electronics. Please consult the applicable EVM user's guide prior to connecting any load to the EVM output. If there is uncertainty as to the load specification, please contact a TI field representative. During normal operation, some circuit components may have case temperatures greater than 60°C as long as the input and output are maintained at a normal ambient operating temperature. These components include but are not limited to linear regulators, switching transistors, pass transistors, and current sense resistors which can be identified using EVMs' schematics located in the applicable EVM user's guide. When placing measurement probes near EVMs during normal operation, please be aware that EVMs may become very warm. As with all electronic evaluation tools, only qualified personnel knowledgeable in electronic measurement and diagnostics normally found in development environments should use EVMs.

Agreement to Defend, Indemnify and Hold Harmless. User agrees to defend, indemnify, and hold TI, its directors, officers, employees, agents, representatives, affiliates, licensors and their representatives harmless from and against any and all claims, damages, losses, expenses, costs and liabilities (collectively, "Claims") arising out of, or in connection with, any handling and/or use of EVMs. User's indemnity shall apply whether Claims arise under law of tort or contract or any other legal theory, and even if EVMs fail to perform as described or expected.

Safety-Critical or Life-Critical Applications. If user intends to use EVMs in evaluations of safety critical applications (such as life support), and a failure of a TI product considered for purchase by user for use in user's product would reasonably be expected to cause severe personal injury or death such as devices which are classified as FDA Class III or similar classification, then user must specifically notify TI of such intent and enter into a separate Assurance and Indemnity Agreement.

RADIO FREQUENCY REGULATORY COMPLIANCE INFORMATION FOR EVALUATION MODULES

Texas Instruments Incorporated (TI) evaluation boards, kits, and/or modules (EVMs) and/or accompanying hardware that is marketed, sold, or loaned to users may or may not be subject to radio frequency regulations in specific countries.

General Statement for EVMs Not Including a Radio

For EVMs not including a radio and not subject to the U.S. Federal Communications Commission (FCC) or Industry Canada (IC) regulations, TI intends EVMs to be used only for engineering development, demonstration, or evaluation purposes. EVMs are not finished products typically fit for general consumer use. EVMs may nonetheless generate, use, or radiate radio frequency energy, but have not been tested for compliance with the limits of computing devices pursuant to part 15 of FCC or the ICES-003 rules. Operation of such EVMs may cause interference with radio communications, in which case the user at his own expense will be required to take whatever measures may be required to correct this interference.

General Statement for EVMs including a radio

User Power/Frequency Use Obligations: For EVMs including a radio, the radio included in such EVMs is intended for development and/or professional use only in legally allocated frequency and power limits. Any use of radio frequencies and/or power availability in such EVMs and their development application(s) must comply with local laws governing radio spectrum allocation and power limits for such EVMs. It is the user's sole responsibility to only operate this radio in legally acceptable frequency space and within legally mandated power limitations. Any exceptions to this are strictly prohibited and unauthorized by TI unless user has obtained appropriate experimental and/or development licenses from local regulatory authorities, which is the sole responsibility of the user, including its acceptable authorization.

U.S. Federal Communications Commission Compliance

For EVMs Annotated as FCC – FEDERAL COMMUNICATIONS COMMISSION Part 15 Compliant

Caution

This device complies with part 15 of the FCC Rules. Operation is subject to the following two conditions: (1) This device may not cause harmful interference, and (2) this device must accept any interference received, including interference that may cause undesired operation. Changes or modifications could void the user's authority to operate the equipment.

FCC Interference Statement for Class A EVM devices

This equipment has been tested and found to comply with the limits for a Class A digital device, pursuant to part 15 of the FCC Rules. These limits are designed to provide reasonable protection against harmful interference when the equipment is operated in a commercial environment. This equipment generates, uses, and can radiate radio frequency energy and, if not installed and used in accordance with the instruction manual, may cause harmful interference to radio communications. Operation of this equipment in a residential area is likely to cause harmful interference in which case the user will be required to correct the interference at its own expense.

FCC Interference Statement for Class B EVM devices

This equipment has been tested and found to comply with the limits for a Class B digital device, pursuant to part 15 of the FCC Rules. These limits are designed to provide reasonable protection against harmful interference in a residential installation. This equipment generates, uses and can radiate radio frequency energy and, if not installed and used in accordance with the instructions, may cause harmful interference to radio communications. However, there is no guarantee that interference will not occur in a particular installation. If this equipment does cause harmful interference to radio or television reception, which can be determined by turning the equipment off and on, the user is encouraged to try to correct the interference by one or more of the following measures:

- Reorient or relocate the receiving antenna.
- Increase the separation between the equipment and receiver.
- Connect the equipment into an outlet on a circuit different from that to which the receiver is connected.
- Consult the dealer or an experienced radio/TV technician for help.

Industry Canada Compliance (English)

For EVMs Annotated as IC – INDUSTRY CANADA Compliant:

This Class A or B digital apparatus complies with Canadian ICES-003.

Changes or modifications not expressly approved by the party responsible for compliance could void the user's authority to operate the equipment.

Concerning EVMs Including Radio Transmitters

This device complies with Industry Canada licence-exempt RSS standard(s). Operation is subject to the following two conditions: (1) this device may not cause interference, and (2) this device must accept any interference, including interference that may cause undesired operation of the device.

Concerning EVMs Including Detachable Antennas

Under Industry Canada regulations, this radio transmitter may only operate using an antenna of a type and maximum (or lesser) gain approved for the transmitter by Industry Canada. To reduce potential radio interference to other users, the antenna type and its gain should be so chosen that the equivalent isotropically radiated power (e.i.r.p.) is not more than that necessary for successful communication.

This radio transmitter has been approved by Industry Canada to operate with the antenna types listed in the user guide with the maximum permissible gain and required antenna impedance for each antenna type indicated. Antenna types not included in this list, having a gain greater than the maximum gain indicated for that type, are strictly prohibited for use with this device.

Canada Industry Canada Compliance (French)

Cet appareil numérique de la classe A ou B est conforme à la norme NMB-003 du Canada

Les changements ou les modifications pas expressément approuvés par la partie responsable de la conformité ont pu vider l'autorité de l'utilisateur pour actionner l'équipement.

Concernant les EVMs avec appareils radio

Le présent appareil est conforme aux CNR d'Industrie Canada applicables aux appareils radio exempts de licence. L'exploitation est autorisée aux deux conditions suivantes : (1) l'appareil ne doit pas produire de brouillage, et (2) l'utilisateur de l'appareil doit accepter tout brouillage radioélectrique subi, même si le brouillage est susceptible d'en compromettre le fonctionnement.

Concernant les EVMs avec antennes détachables

Conformément à la réglementation d'Industrie Canada, le présent émetteur radio peut fonctionner avec une antenne d'un type et d'un gain maximal (ou inférieur) approuvé pour l'émetteur par Industrie Canada. Dans le but de réduire les risques de brouillage radioélectrique à l'intention des autres utilisateurs, il faut choisir le type d'antenne et son gain de sorte que la puissance isotrope rayonnée équivalente (p.i.r.e.) ne dépasse pas l'intensité nécessaire à l'établissement d'une communication satisfaisante.

Le présent émetteur radio a été approuvé par Industrie Canada pour fonctionner avec les types d'antenne énumérés dans le manuel d'usage et ayant un gain admissible maximal et l'impédance requise pour chaque type d'antenne. Les types d'antenne non inclus dans cette liste, ou dont le gain est supérieur au gain maximal indiqué, sont strictement interdits pour l'exploitation de l'émetteur.

Mailing Address: Texas Instruments, Post Office Box 655303, Dallas, Texas 75265
Copyright © 2014, Texas Instruments Incorporated

Important Notice for Users of EVMs Considered “Radio Frequency Products” in Japan

EVMs entering Japan are NOT certified by TI as conforming to Technical Regulations of Radio Law of Japan.

If user uses EVMs in Japan, user is required by Radio Law of Japan to follow the instructions below with respect to EVMs:

1. Use EVMs in a shielded room or any other test facility as defined in the notification #173 issued by Ministry of Internal Affairs and Communications on March 28, 2006, based on Sub-section 1.1 of Article 6 of the Ministry's Rule for Enforcement of Radio Law of Japan,
2. Use EVMs only after user obtains the license of Test Radio Station as provided in Radio Law of Japan with respect to EVMs, or
3. Use of EVMs only after user obtains the Technical Regulations Conformity Certification as provided in Radio Law of Japan with respect to EVMs. Also, do not transfer EVMs, unless user gives the same notice above to the transferee. Please note that if user does not follow the instructions above, user will be subject to penalties of Radio Law of Japan.

<http://www.tij.co.jp>

【無線電波を送信する製品の開発キットをお使いになる際の注意事項】本開発キットは技術基準適合証明を受けておりません。本製品のご使用に際しては、電波法遵守のため、以下のいずれかの措置を取っていただく必要がありますのでご注意ください。

1. 電波法施行規則第6条第1項第1号に基づく平成18年3月28日総務省告示第173号で定められた電波暗室等の試験設備でご使用いただく。
2. 実験局の免許を取得後ご使用いただく。
3. 技術基準適合証明を取得後ご使用いただく。。

なお、本製品は、上記の「ご使用にあたっての注意」を譲渡先、移転先に通知しない限り、譲渡、移転できないものとします

上記を遵守頂けない場合は、電波法の罰則が適用される可能性があることをご留意ください。

日本テキサス・インスツルメンツ株式会社

東京都新宿区西新宿6丁目24番1号

西新宿三井ビル

<http://www.tij.co.jp>

Texas Instruments Japan Limited

(address) 24-1, Nishi-Shinjuku 6 chome, Shinjuku-ku, Tokyo, Japan

IMPORTANT NOTICE

Texas Instruments Incorporated and its subsidiaries (TI) reserve the right to make corrections, enhancements, improvements and other changes to its semiconductor products and services per JESD46, latest issue, and to discontinue any product or service per JESD48, latest issue. Buyers should obtain the latest relevant information before placing orders and should verify that such information is current and complete. All semiconductor products (also referred to herein as "components") are sold subject to TI's terms and conditions of sale supplied at the time of order acknowledgment.

TI warrants performance of its components to the specifications applicable at the time of sale, in accordance with the warranty in TI's terms and conditions of sale of semiconductor products. Testing and other quality control techniques are used to the extent TI deems necessary to support this warranty. Except where mandated by applicable law, testing of all parameters of each component is not necessarily performed.

TI assumes no liability for applications assistance or the design of Buyers' products. Buyers are responsible for their products and applications using TI components. To minimize the risks associated with Buyers' products and applications, Buyers should provide adequate design and operating safeguards.

TI does not warrant or represent that any license, either express or implied, is granted under any patent right, copyright, mask work right, or other intellectual property right relating to any combination, machine, or process in which TI components or services are used. Information published by TI regarding third-party products or services does not constitute a license to use such products or services or a warranty or endorsement thereof. Use of such information may require a license from a third party under the patents or other intellectual property of the third party, or a license from TI under the patents or other intellectual property of TI.

Reproduction of significant portions of TI information in TI data books or data sheets is permissible only if reproduction is without alteration and is accompanied by all associated warranties, conditions, limitations, and notices. TI is not responsible or liable for such altered documentation. Information of third parties may be subject to additional restrictions.

Resale of TI components or services with statements different from or beyond the parameters stated by TI for that component or service voids all express and any implied warranties for the associated TI component or service and is an unfair and deceptive business practice. TI is not responsible or liable for any such statements.

Buyer acknowledges and agrees that it is solely responsible for compliance with all legal, regulatory and safety-related requirements concerning its products, and any use of TI components in its applications, notwithstanding any applications-related information or support that may be provided by TI. Buyer represents and agrees that it has all the necessary expertise to create and implement safeguards which anticipate dangerous consequences of failures, monitor failures and their consequences, lessen the likelihood of failures that might cause harm and take appropriate remedial actions. Buyer will fully indemnify TI and its representatives against any damages arising out of the use of any TI components in safety-critical applications.

In some cases, TI components may be promoted specifically to facilitate safety-related applications. With such components, TI's goal is to help enable customers to design and create their own end-product solutions that meet applicable functional safety standards and requirements. Nonetheless, such components are subject to these terms.

No TI components are authorized for use in FDA Class III (or similar life-critical medical equipment) unless authorized officers of the parties have executed a special agreement specifically governing such use.

Only those TI components which TI has specifically designated as military grade or "enhanced plastic" are designed and intended for use in military/aerospace applications or environments. Buyer acknowledges and agrees that any military or aerospace use of TI components which have **not** been so designated is solely at the Buyer's risk, and that Buyer is solely responsible for compliance with all legal and regulatory requirements in connection with such use.

TI has specifically designated certain components as meeting ISO/TS16949 requirements, mainly for automotive use. In any case of use of non-designated products, TI will not be responsible for any failure to meet ISO/TS16949.

Products

Audio	www.ti.com/audio
Amplifiers	amplifier.ti.com
Data Converters	dataconverter.ti.com
DLP® Products	www.dlp.com
DSP	dsp.ti.com
Clocks and Timers	www.ti.com/clocks
Interface	interface.ti.com
Logic	logic.ti.com
Power Mgmt	power.ti.com
Microcontrollers	microcontroller.ti.com
RFID	www.ti-rfid.com
OMAP Applications Processors	www.ti.com/omap
Wireless Connectivity	www.ti.com/wirelessconnectivity

Applications

Automotive and Transportation	www.ti.com/automotive
Communications and Telecom	www.ti.com/communications
Computers and Peripherals	www.ti.com/computers
Consumer Electronics	www.ti.com/consumer-apps
Energy and Lighting	www.ti.com/energy
Industrial	www.ti.com/industrial
Medical	www.ti.com/medical
Security	www.ti.com/security
Space, Avionics and Defense	www.ti.com/space-avionics-defense
Video and Imaging	www.ti.com/video

TI E2E Community

e2e.ti.com