



***UCC2540 Secondary Side Post
Regulator Evaluation Module With
the UCC38083***

User's Guide

EVM IMPORTANT NOTICE (CATEGORY B)

IMPORTANT: TI is providing the enclosed **HPA054** evaluation module under the following conditions:

This evaluation module (EVM) being provided by Texas Instruments (TI) is intended for use for **ENGINEERING DEVELOPMENT OR EVALUATION PURPOSES ONLY** and is not considered by Texas Instruments to be fit for commercial use. As such, this EVM may not be complete in terms of design and/or manufacturing related protective considerations including product safety measures typically found in the end-product incorporating the module. As a prototype, this product does not fall within the scope of the European Union Directive on electromagnetic compatibility and on low voltage and therefore may not meet the technical requirements of the directive. This EVM is not subject to the EU marking requirements.

- Should this EVM not meet the specifications indicated in the User's Guide the EVM may be returned within 30 days from the date of delivery for a full refund. **THE FOREGOING WARRANTY IS THE EXCLUSIVE WARRANTY MADE BY TI AND IS IN LIEU OF ALL OTHER WARRANTIES, EXPRESSED, IMPLIED, OR STATUTORY, INCLUDING ANY WARRANTY OF MERCHANTABILITY OR FITNESS FOR ANY PARTICULAR PURPOSE.**
- The user assumes all responsibility and liability for proper and safe handling of the EVM. The user acknowledge that the use of the EVM could present serious hazards and that it is the user's responsibility to take all precautions for the handling and use of the EVMs in accordance with good laboratory practices. Please be aware that the products received may not be regulatory compliant or agency certified (FCC, UL, etc.). Due to the open construction of the product, it is the user's responsibility to take any and all appropriate precautions with regard to electrostatic discharge.
- **NEITHER PARTY WILL BE LIABLE TO THE OTHER FOR ANY INDIRECT, SPECIAL, INCIDENTAL, OR CONSEQUENTIAL DAMAGES.**
- TI is currently dealing with various customers for products, and therefore our arrangement with the user **will not be exclusive.**
- TI assumes **no liability for applications assistance, customer product design, software performance, or infringement of patents or services described herein.**
- Please read the User's Guide and specifically the section in the User's Guide pertaining to warnings and restrictions prior to handling the product. This section contains important information regarding high temperature and voltages which TI recommends to be read before handling the EVMs. In case of any doubt regarding safety, please contact the TI application engineer.
- Persons handling the product should have electronics training and observe good laboratory practice standards.
- No license is granted under any patent right or other intellectual property right of TI covering or relating to any combination, machine, or process in which such TI products or services might be or are used.
- This Agreement is subject to the laws of the State of Texas, excluding the body of conflicts of laws and the United Nations Convention on the International Sale of Goods, and will be subject to the exclusive jurisdiction of the courts of the State of Texas.

DYNAMIC WARNINGS AND RESTRICTIONS

It is important to operate this EVM within the maximum input voltage ranges specified in section 5.

Exceeding the specified input range may cause unexpected operation and/or irreversible damage to the EVM. If there are questions concerning the input range, please contact a TI field representative prior to connecting the input power.

Applying loads outside of the specified output range may result in unintended operation and/or possible permanent damage to the EVM. Please consult the EVM User's Guide prior to connecting any load to the EVM output. If there is uncertainty as to the load specification, please contact a TI field representative.

During normal operation, some circuit components may have case temperatures greater than 50°C. The EVM is designed to operate properly with certain components above 50°C as long as the input and output ranges are maintained. These components include but are not limited to linear regulators, switching transistors, pass transistors, and current sense resistors. These types of devices can be identified using the EVM schematic located in the EVM User's Guide. When placing measurement probes near these devices during operation, please be aware that these devices may be very warm to the touch.

Mailing Address:

Texas Instruments
Post Office Box 655303
Dallas, Texas 75265

Copyright © 2004, Texas Instruments Incorporated

UCC2540 Secondary-Side Post Regulator Evaluation Module With the UCC38083

Lisa Dinwoodie

Power Supply Control Products

ABSTRACT

The UCC2540 is a voltage-mode secondary-side synchronous-buck PWM controller for high current and low output voltage applications.

Contents

| | | |
|------------|---|-----------|
| 1 | Introduction | 4 |
| 2. | Description | 5 |
| 3. | Applications | 5 |
| 4. | Features | 6 |
| 5. | Electrical Performance Specifications | 6 |
| 6. | Schematic | 7 |
| 7. | Test Setup | 10 |
| 8. | Power Up/Down Sequence | 11 |
| 9. | Performance Data and Characteristic Curves | 12 |
| 10. | EVM Assembly Drawing and PCB Layout. | 18 |
| 11. | List of Material | 23 |
| 12. | References | 25 |

1 Introduction

The UCC2540 is a voltage-mode secondary-side synchronous-buck PWM controller for high current and low output voltage applications. It can be used as either a secondary-side post regulator (SSPR) for generating additional auxiliary outputs for multiple output power supplies or as a local secondary side controller for isolated dc-to-dc converters in cascaded topologies. The input is synchronized to a pulsed signal derived from either the secondary winding of the main transformer or from a pulse transformer from the primary side. In SSPR applications, the primary side control for the main output can be generated by any buck derived topology such as forward, push-pull, half-bridge, or full-bridge. The UCC2540 is a high efficiency controller that provides tight regulation, fast transient response, and is a cost effective solution for multiple output power supplies and cascaded converters.

2 Description

This UCC2540 secondary side post regulator evaluation module adds an auxiliary output to an existing current-mode controlled converter. The leading edge modulation of the UCC2540 makes it easily compatible with either voltage-mode or current-mode control primary stages used in topologies such as forward, half-bridge, or push-pull. This evaluation module takes the UCC38083 push-pull 3.3-V output converter and adds a 1.5-V, 7.5-A output. The UCC38083 gate drive transformer, used to drive the push-pull synchronous rectifiers, provides an ideal synchronization pulse for the UCC2540. Bias to the device is provided by the existing rectified bias used to power the discrete driver circuit on the secondary side and the power stage for the UCC2540 synchronous buck is directly tapped off of the secondary side winding of the main transformer, minimizing the size of the main converter's inductor and output capacitors. If more outputs are desired for a given design, additional synchronously rectified and independently regulated outputs can easily be added using the same method shown here, each controlled with a UCC2540 benefiting from their own soft start, current limit, and on/off control.

The UCC2540/UCC38083EVM highlights the many benefits of using the UCC2540 secondary side synchronous buck PWM controller in conjunction with the UCC38083 current mode control PWM controller. The following user guide provides the schematic, component list, assembly drawing, artwork, and test set up necessary to evaluate the UCC2540 and UCC38083 in a typical multiple output application.

3 Applications

- Secondary-side post regulation (SSPR) for multiple output power supplies
- Cascaded buck converters
- Can replace magnetic amplifiers and other inefficient solutions for high current multiple output power supplies
- Post processing converters for bus converter and dc transformer architectures
- Can be used in telecommunication and data communication equipment, industrial and computer power supplies, test and medical instrumentation, as well as for merchant power supplies

4 Features

- Voltage mode control
- 24-V typical input voltage
- 3.3-V, 7.5-A output
- 1.5-V, 7.5-A output
- 400-kHz secondary-side switching frequency, 200-kHz primary-side switching frequency
- User programmable shutdown for the auxiliary output
- Parallel average current mode control loop for two levels of overcurrent protection: constant current limit and overcurrent reset/retry
- On-Chip Predictive Gate Drive™ for high efficiency synchronous buck operation by minimizing body diode conduction and reverse recovery losses in the synchronous rectifier
- Dual ± 3 -A TrueDrive™ outputs suitable for high current applications
- Leading edge modulation
- High bandwidth error amplifiers
- Thermally enhanced HTSSOP 20-pin PowerPAD™ package which is housed in a standard 20-pin TSSOP footprint but has a drastically lower thermal impedance of $2^{\circ}\text{C}/\text{W}$ θ_{JC} to accommodate the dual high-current on-board drivers
- Tracking pin for output sequencing using sequential, ratiometric, or simultaneous methods

5 Electrical Performance Specification

Table 1. Electrical Performance Specifications

| PARAMETER | | CONDITIONS | MIN | TYP | MAX | UNITS |
|---------------------------|----------------------|--|------|-----|------|--------------------------|
| Input voltage range | V_{IN} | | 18.5 | 24 | 35 | |
| Output voltage regulation | V_{OUT1} | $0 \text{ A} < I_{\text{OUT1}} < 7.5 \text{ A}$ | 3.24 | | 3.36 | V |
| | V_{OUT2} | $0 \text{ A} < I_{\text{OUT2}} < 7.5 \text{ A}$ | 1.47 | | 1.53 | |
| Output voltage ripple | V_{RIPPLE1} | $V_{\text{IN}} = 35 \text{ V}, I_{\text{OUT1}} = 7.5 \text{ A}$ | | | 66 | $\text{mV}_{\text{p-p}}$ |
| | V_{RIPPLE2} | $V_{\text{IN}} = 35 \text{ V}, I_{\text{OUT2}} = 7.5 \text{ A}$ | | | 30 | |
| Output load current | I_{OUT1} | $V_{\text{OUT1}} = 3.3 \text{ V}$ | 0 | | 7.5 | A |
| | I_{OUT2} | $V_{\text{OUT2}} = 1.5 \text{ V}$ | 0 | | 7.5 | |
| Efficiency | | $V_{\text{IN}} = 19 \text{ V}$ $I_{\text{OUT1}} = 4.5 \text{ A}$ $I_{\text{OUT2}} = 4.5 \text{ A}$ | | 86 | | % |

6 Schematic

A schematic of the UCC2540/UCC38083EVM is shown in Figure 1. The primary-side consists of the current-mode UCC38083 pulse-width modulator configured for 200-kHz switching frequency in a push-pull configuration to generate a 3.3-V output. The output signals of the UCC38083 are fed into a TPS2812 driver to turn on and off the main switches and are also sent across the isolation boundary using a pulse edge transformer to the secondary side to control the discrete driver circuit for the synchronous rectifiers. The voltage feedback from the 3.3-V output is transferred across the isolation boundary with an optocoupler. This circuit is identical to the UCC38083 reference design found in the UCC38083 product folder.[3]

The same pulse edge signal that controls the 3.3-V secondary-side synchronous rectifiers is used as the synchronization signal to the UCC2540 to control the auxiliary 1.5-V output. The synchronization signal switches at 400 kHz. The 1.5-V output is generated with a synchronous buck circuit controlled by the UCC2540 in a mode 2 biasing configuration. The pulse train output of the main transformer is connected to the drain of the high-side FET. Bias to the UCC2540 is provided by the same bias circuit used by the discrete drive components on the 3.3-V secondary side and is approximately 6 V which determines mode 2 operation, as detailed in the UCC2540 data sheet.[1] Charging currents for the closed loop soft start, PWM ramp generator, and the maximum on-time duration of the synchronous rectifier are all established with the RSET resistor. The REF pin is decoupled as close to the device as possible with a good quality ceramic capacitor as is the VDD and VDRV pins. Type III compensation closes the voltage mode control loop as well as the over current protection loop. A charge pump is used to drive the high-side FET. The sense pins for the SW node and the low side FET gate drive, SWS and G2S, must be connected as close as possible to the drain and gate, respectively, of the low side switch. Do not connect them directly at the device pins as the sense signals are crucial to optimum Predictive Gate Drive™ functionality. To shut down the auxiliary output, a 3-V signal can be applied to J5. Test points are provided on the EVM for the user. Always use a differential probe from TP24, referenced to TP26 when looking at the high-side FET gate drive signal.

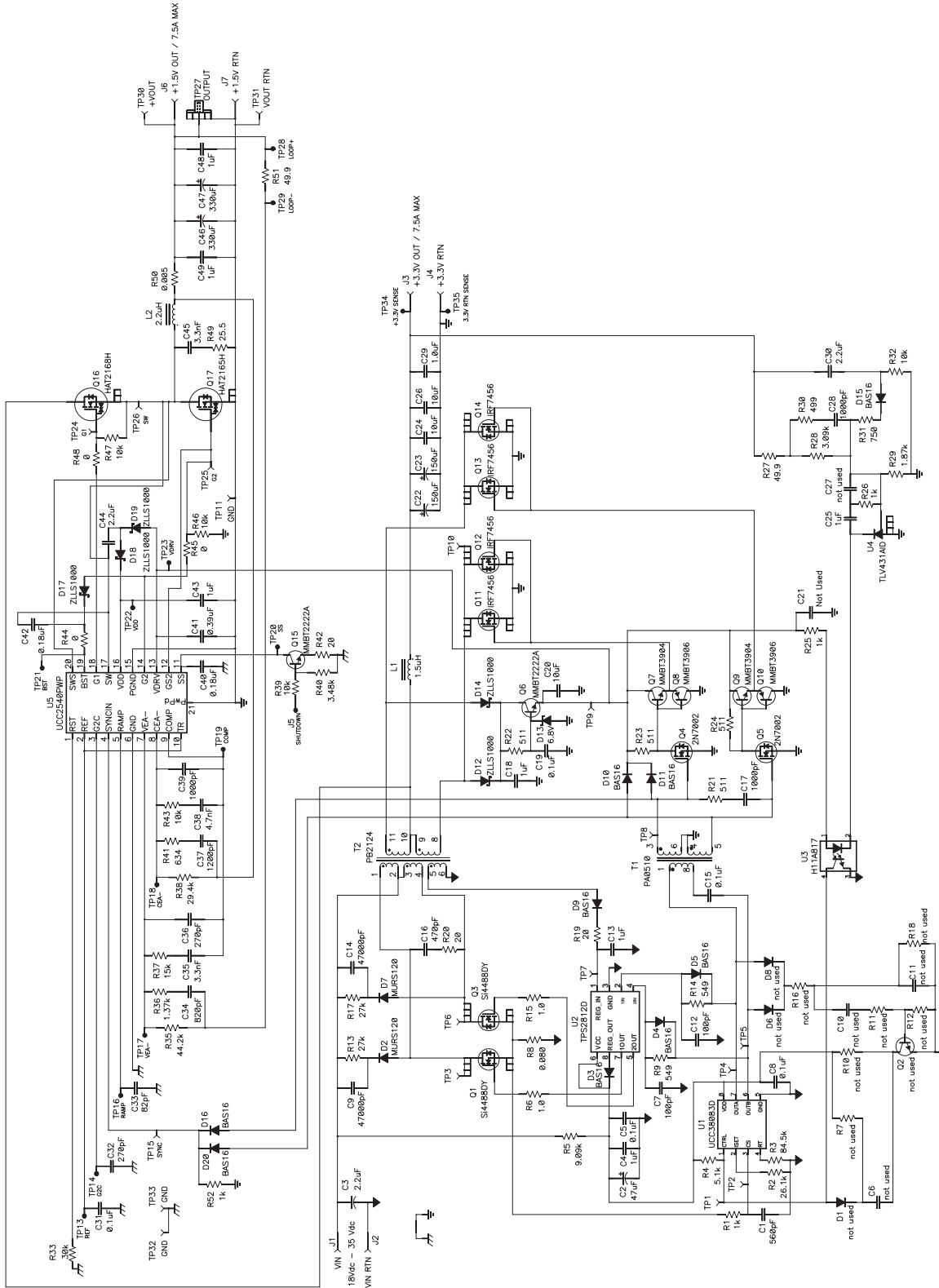

Figure 1. Schematic of the UCC2540/UCC38083 Evaluation Module

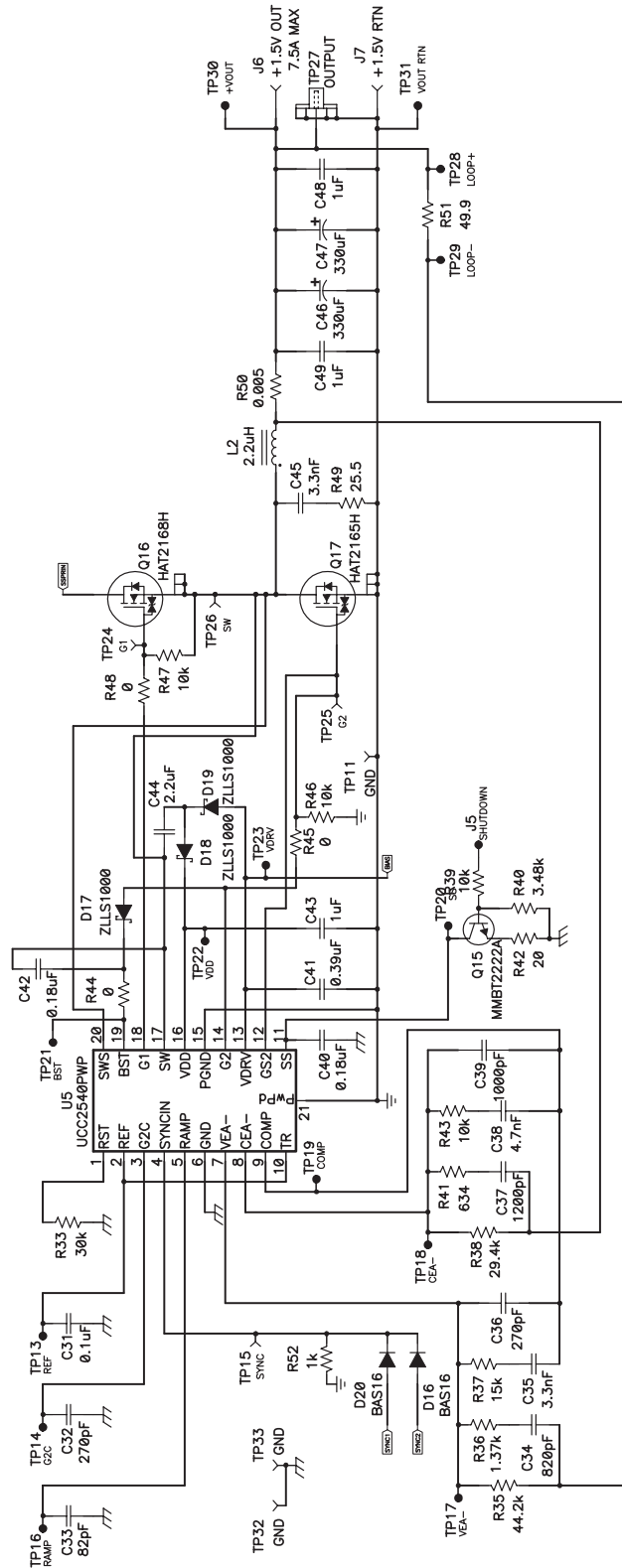

Figure 2. Schematic of the UCC2540 Section of the EVM

7 Test Setup

Shown below in Figure 3 is the basic test set up recommended to evaluate the UCC2540/UCC38083EVM.

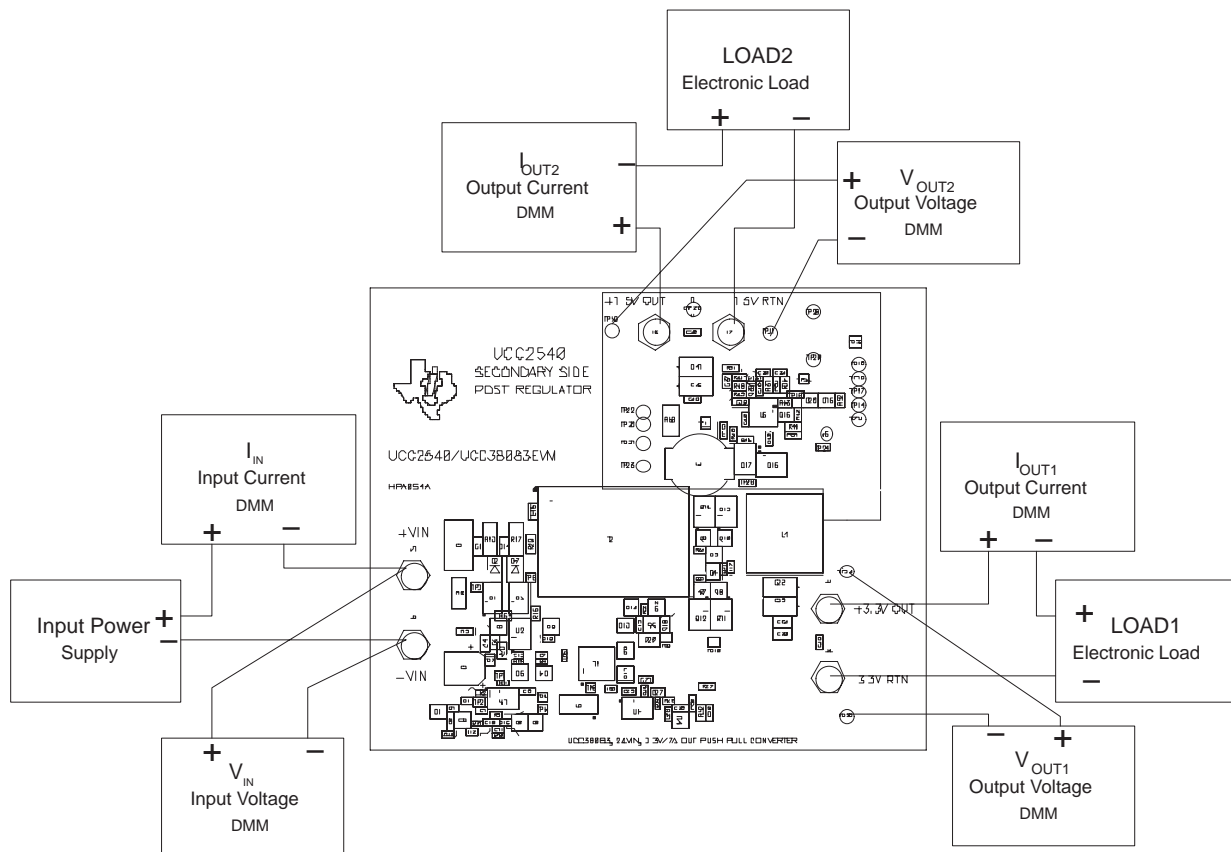

Figure 3. Recommended EVM Test Configuration

7.1 Output Loads (LOAD1 and LOAD2)

For the output loads to V_{OUT1} and V_{OUT2} , programmable electronic loads, LOAD1 and LOAD2, set to constant current mode and capable of sinking 7.5 A at 3.3 V and 1.5 V, respectively, are used. Using a dc voltmeter, measure the output voltages, V_{OUT1} and V_{OUT2} , directly at the test points provided. Avoid measuring the output voltages at the J3/J4 and J6/J7 output terminals, especially at higher load currents due to finite voltage drops across the connectors. Measure each of the output currents, I_{OUT1} and I_{OUT2} , with a dc ammeter connected in series with the loads.

7.2 Input Power Supply (V_{IN})

The input voltage source shall be a variable dc source capable of supplying between 0 V_{DC} and 35 V_{DC} , measured with a dc voltmeter, V_{IN} , at no less than 4 A_{DC} and connected across the input terminals as shown. For fault protection to the EVM, limit the source current to not more than 3 A_{DC} . A dc ammeter, used to measure I_{IN} , should be placed in series with the input source supply as shown.

7.3 Network Analyzer (not shown)

To measure the closed loop response of the auxiliary output, a network analyzer can be connected directly across TP28 and TP29. The 49.9- Ω resistor (R51) between the output load and the voltage feedback allows for non-invasive measurement of the control to output loop response.

8 Power Up/Down Sequence

The following procedure is recommended primarily for powering up and shutting down the UCC2540/UCC38083EVM. Never walk away from a powered evaluation module for extended periods of time.

8.1 Power Up Sequence

- Turn on the electronic load, LOAD1. Set the electronic load to 1.5 A.
- Turn on the electronic load, LOAD2. Set the electronic load to 1.5 A.
- Turn on the input power supply. Starting with the input dc power supply at the zero volt setting, slowly increase the voltage to the EVM operating range, 18.5 V to 35 V.
- The converter will begin operating when the input voltage is at or before 16.5 V maximum, measured on the V_{IN} DMM.

8.2 Power Down Sequence

- Decrease the input power supply to 0 V and turn it off.
- Turn off both electronic loads.

9 Performance Data and Characteristic Curves

TYPICAL WAVEFORMS

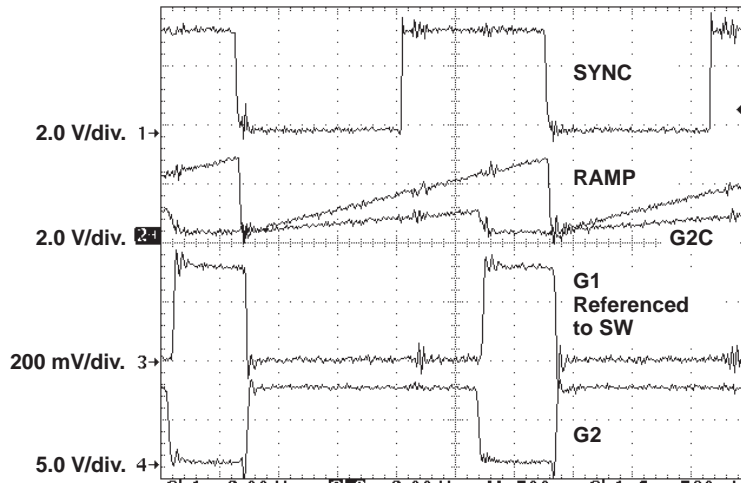

t – Time – 500 ns/div.

Figure 4.

TURN ON TRAJECTORY

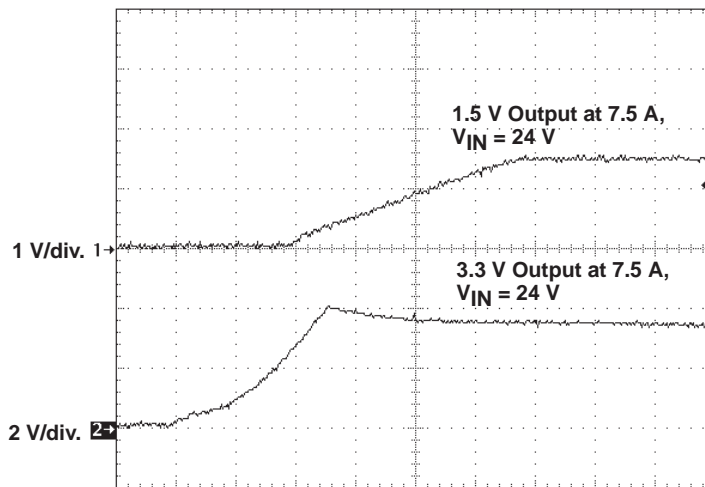

t – Time – 1.0 ms/div.

Figure 5.

OUTPUT VOLTAGE RIPPLE AT 35-V_{IN}, FULL LOAD

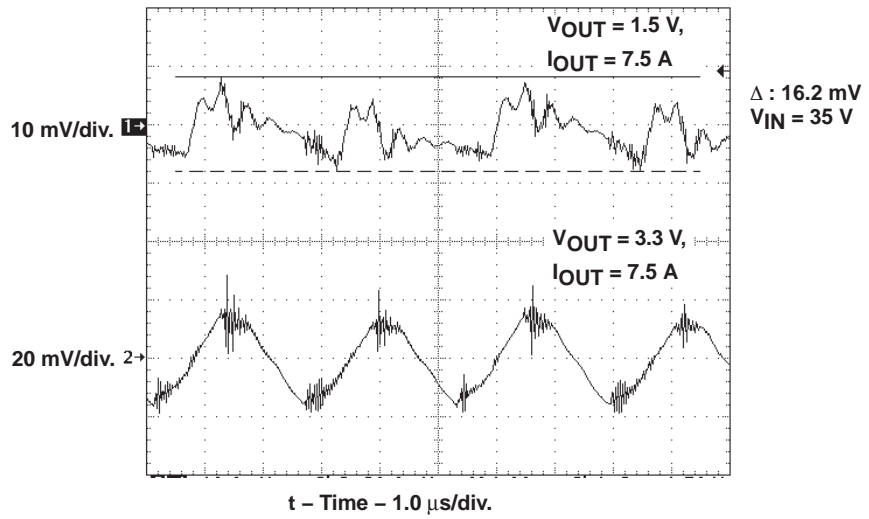

Figure 6.

1.5-V OUTPUT LOAD TRANSIENT RESPONSE

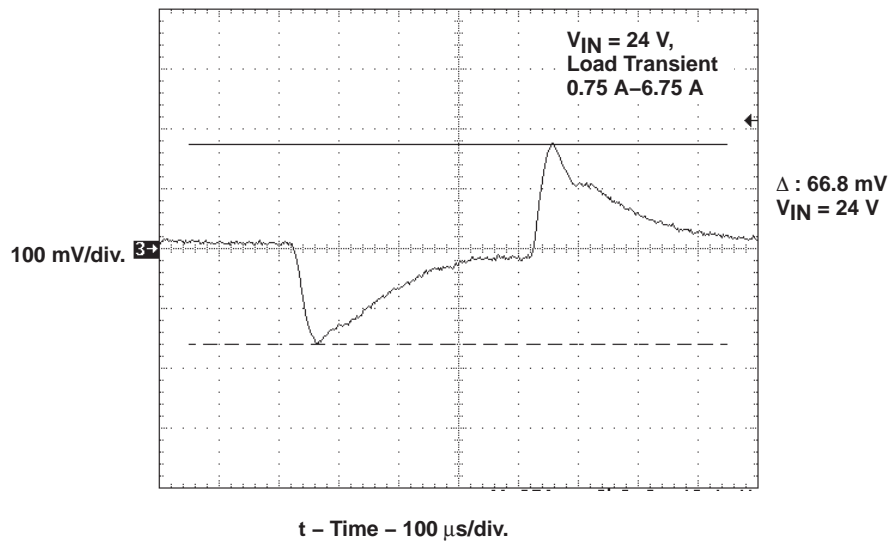

Figure 7.

PREDICTIVE GATE DRIVE

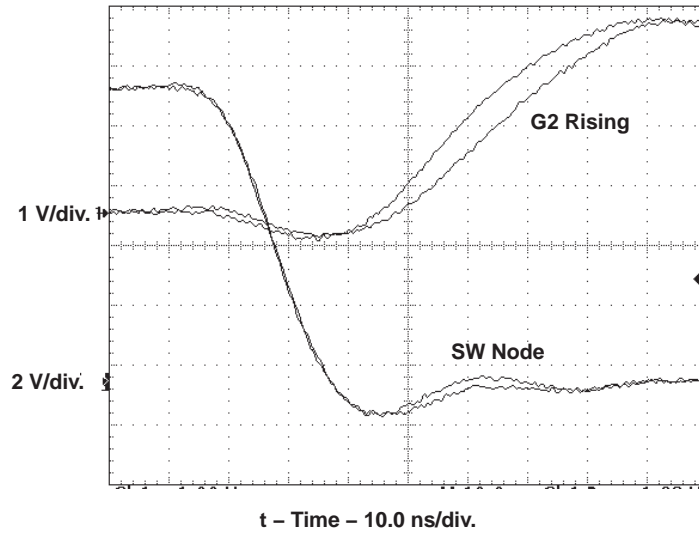

Figure 8.

PREDICTIVE GATE DRIVE

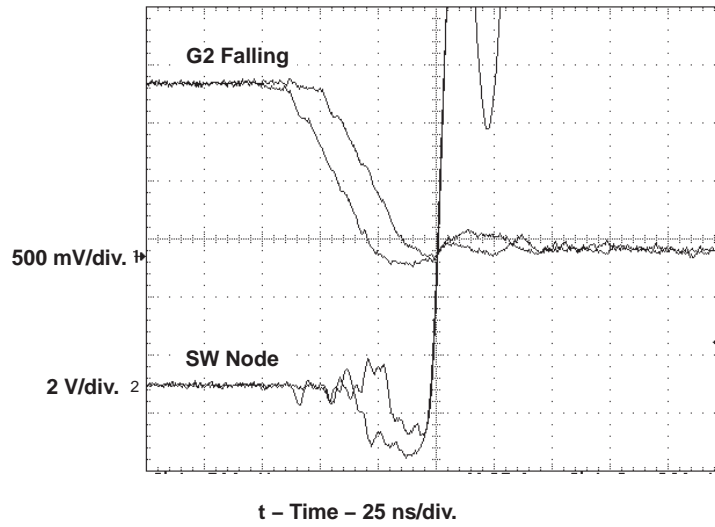

Figure 9.

CONVERTER SHUTDOWN

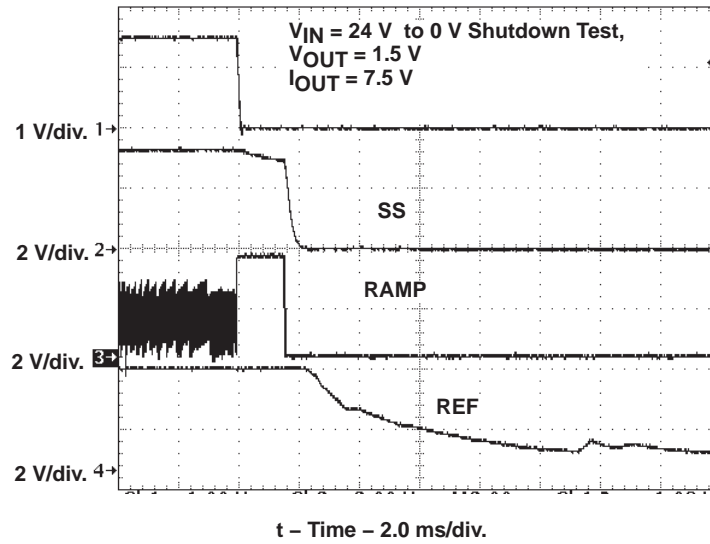

Figure 10.

OVERCURRENT PROTECTION

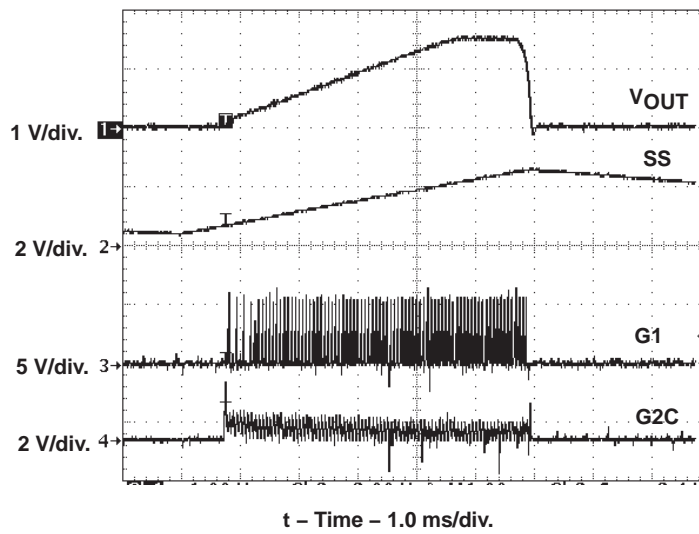

Figure 11.

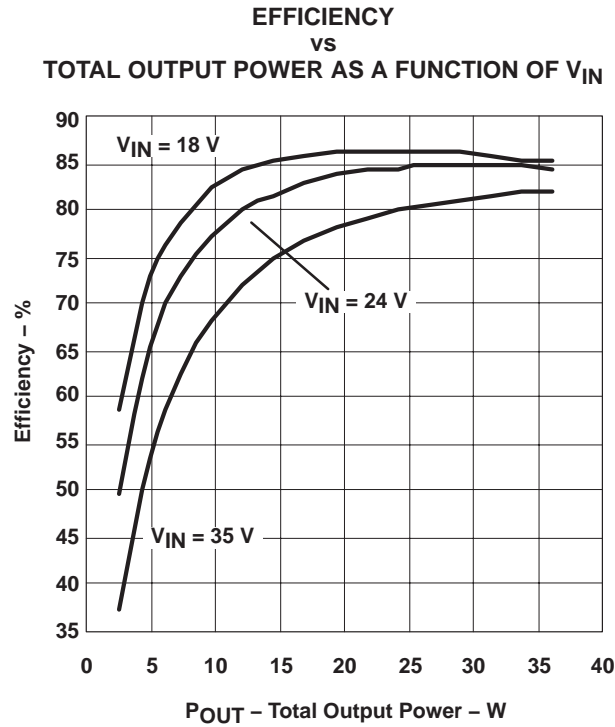

Figure 12.

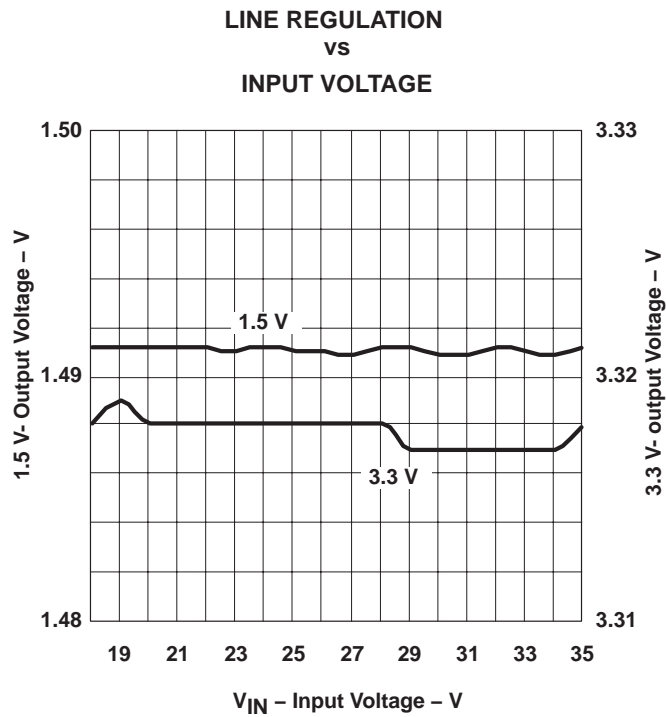

Figure 13.

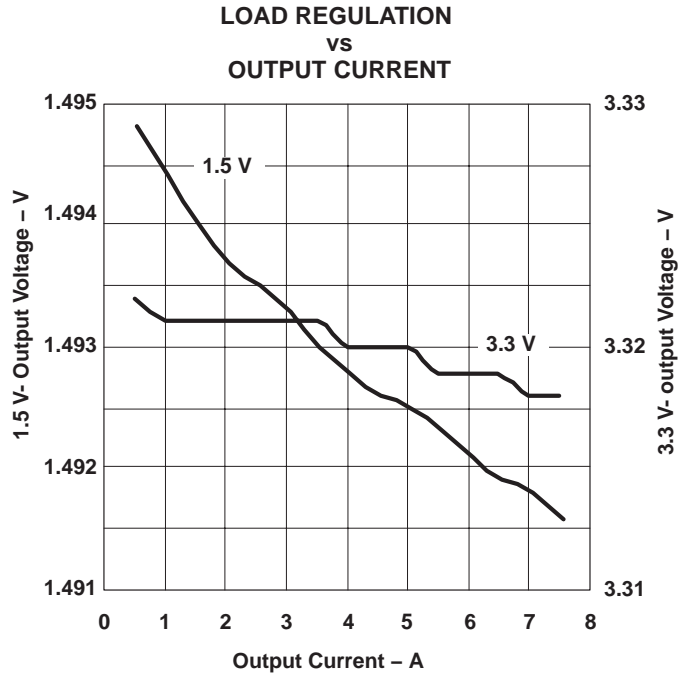

Figure 14.

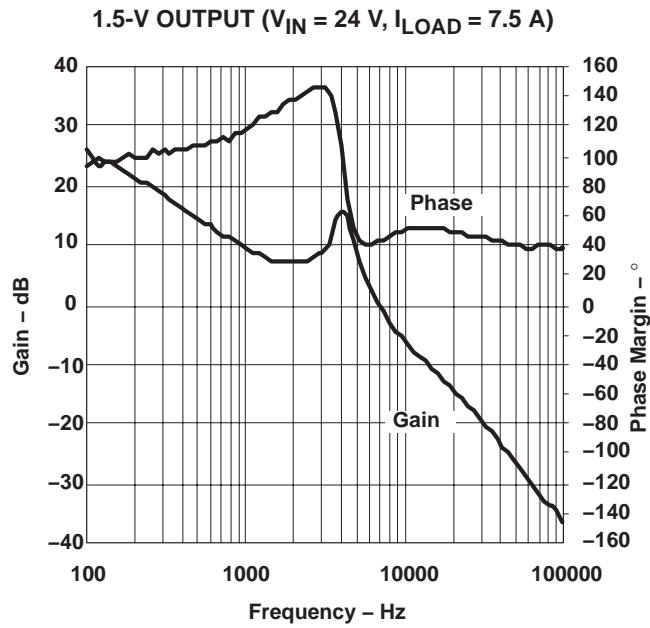

Figure 15.

10 EVM Assembly Drawing and PCB Layout

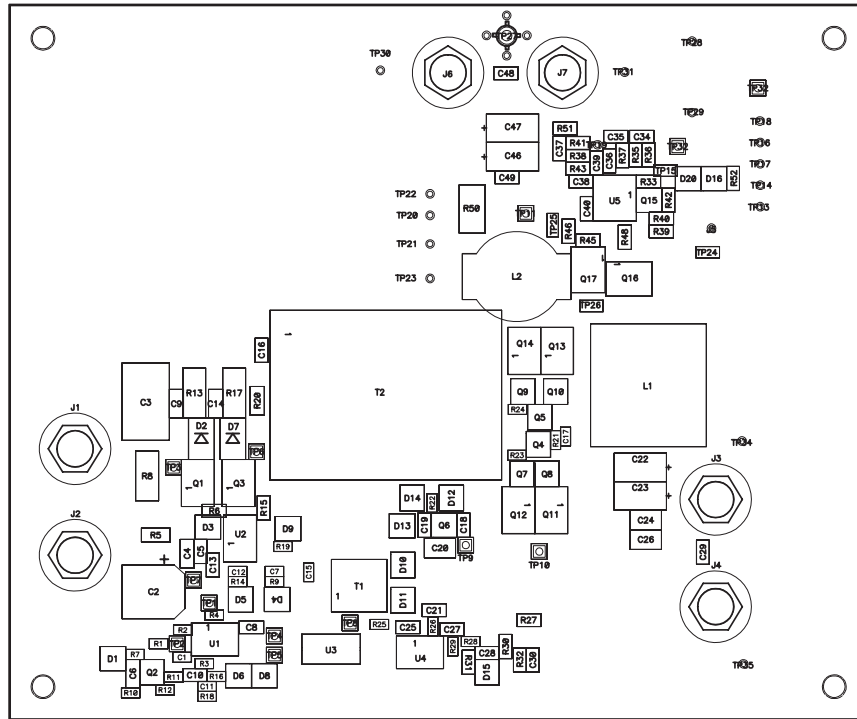

Figure 16. Top Assembly

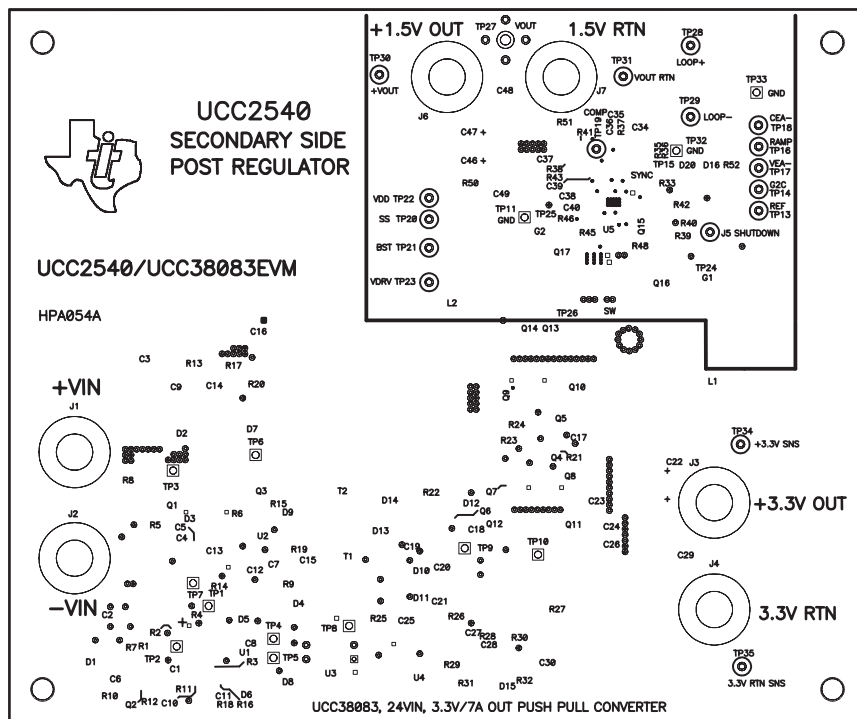

Figure 17. Top Silk

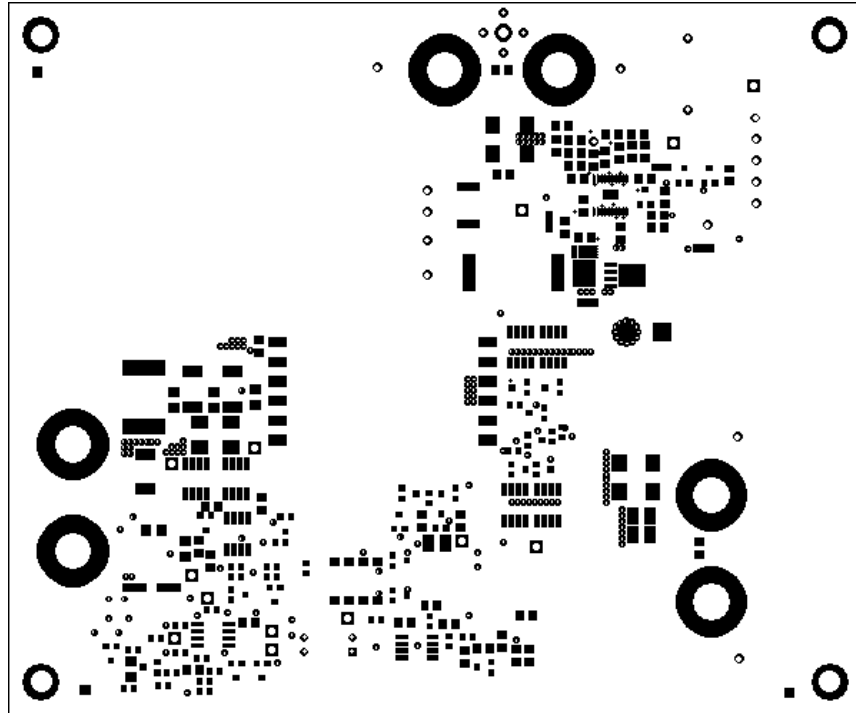

Figure 18. Top Mask

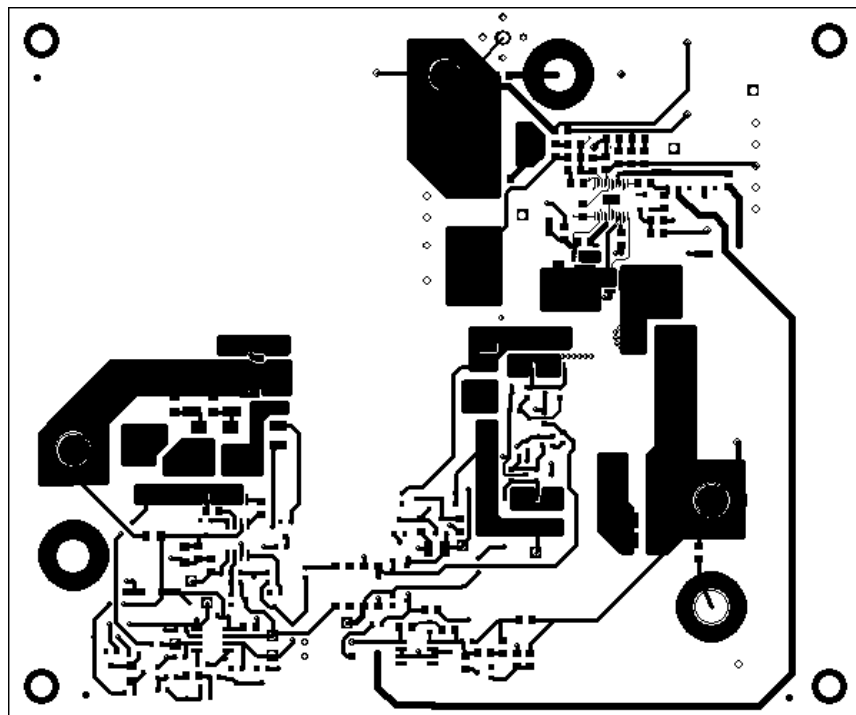

Figure 19. Top Route

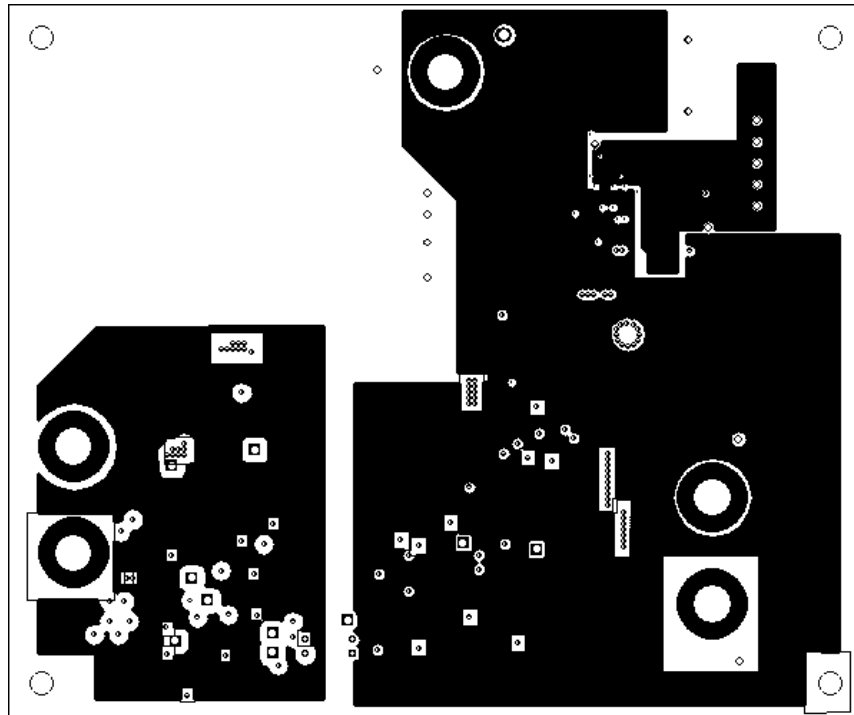

Figure 20. Layer 2 Route

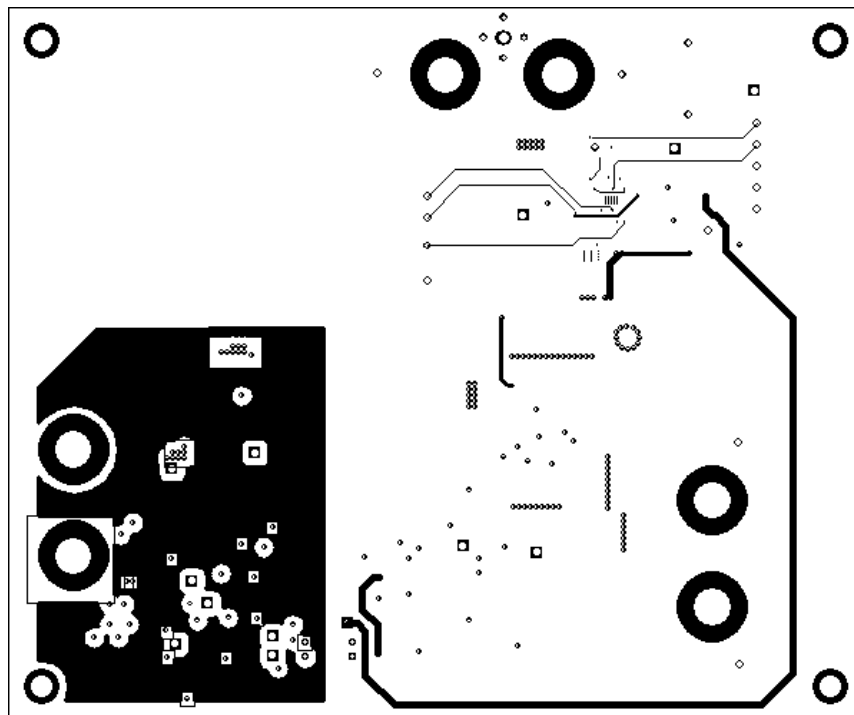

Figure 21. Layer 3 Route

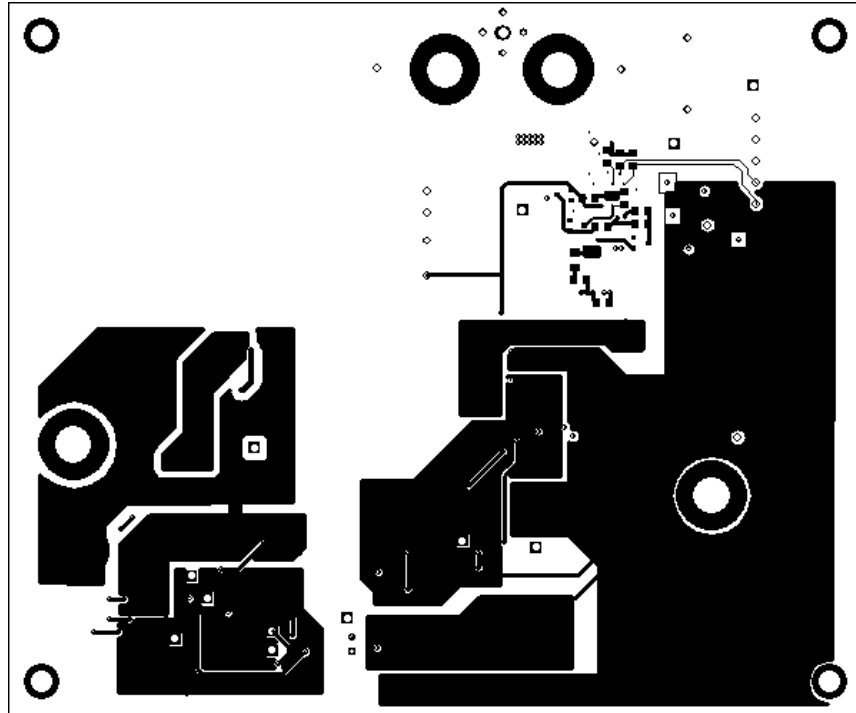

Figure 22. Bottom Route

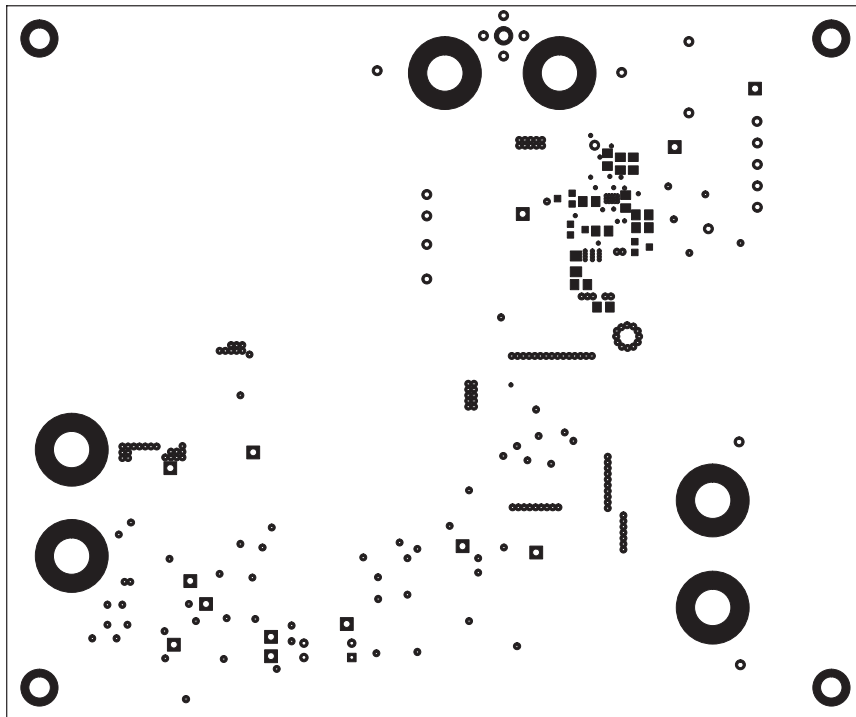

Figure 23. Bottom Mask

11 List of Materials

| REF DES | QTY | DESCRIPTION | MFR | PART NUMBER |
|---|----------|--|-------------------------|---------------|
| C1 | 1 | Capacitor, ceramic, 560 pF, 50 V, X7R, $\pm 10\%$, 0603 | Std | Std |
| C2 | 1 | Capacitor, aluminum, 47 μ F, 16 V, $\pm 20\%$, HA series, 0.335 x 0.374 | Panasonic | EEV-HA1C470P |
| C3 | 1 | Capacitor, film, 2.2 μ F, 100 V, $\pm 10\%$, ST3827 | ITW PAKTON | 225K100ST3827 |
| C4 | 1 | Capacitor, ceramic, 1 μ F, 16 V, X7R, $\pm 10\%$, 1206 | Std | Std |
| C5, C8, C19, C31 | 4 | Capacitor, ceramic, 0.1 μ F, 50 V, X7R, $\pm 10\%$, 0805 | Std | Std |
| C6 | not used | not used, 1206 | | |
| C7, C12 | 2 | Capacitor, ceramic, 100 pF, 50 V, NP0, $\pm 5\%$, 0603 | Std | Std |
| C9, C14 | 2 | Capacitor, ceramic, 47000 pF, 50 V, X7R, $\pm 10\%$, 1206 | Std | Std |
| C10, C21, C27 | not used | not used, 0805 | | |
| C11 | not used | not used, 0603 | | |
| C13, C18, C25, C29, C43, C48, C49 | 7 | Capacitor, ceramic, 1 μ F, 16 V, X7R, $\pm 10\%$, 0805 | Std | Std |
| C15 | 1 | Capacitor, ceramic, 0.1 μ F, 16 V, X7R, $\pm 10\%$, 0603 | Std | Std |
| C16 | 1 | Capacitor, ceramic, 470 pF, 200 V, X7R, $\pm 10\%$, 0805 | Std | Std |
| C17 | 1 | Capacitor, ceramic, 1000 pF, 50 V, X7R, $\pm 10\%$, 0603 | Std | Std |
| C20, C24, C26 | 3 | Capacitor, ceramic, 10 μ F, 16 V, X5R, $\pm 10\%$, 1210 | Std | Std |
| C22, C23 | 2 | Capacitor, POSCAP, 150 μ F, 6.3 V, 55 m Ω , $\pm 20\%$, 7343(D) | Sanyo | 6TPB150ML |
| C28 | 1 | Capacitor, ceramic, 1000 pF, 50 V, C0G, $\pm 5\%$, 0805 | Std | Std |
| C30 | 1 | Capacitor, ceramic, 2.2 μ F, 6.3 V, X5R, $\pm 10\%$, 0805 | Std | Std |
| C32 | 1 | Capacitor, ceramic, 270 pF, 50 V, NP0, $\pm 5\%$, 0805 | Std | Std |
| C33 | 1 | Capacitor, ceramic, 82 pF, 50 V, NP0, $\pm 5\%$, 0805 | Std | Std |
| C34 | 1 | Capacitor, ceramic, 820 pF, 50 V, X7R, $\pm 10\%$, 0805 | Std | Std |
| C35, C45 | 2 | Capacitor, ceramic, 3.3 nF, 50 V, X7R, $\pm 10\%$, 0805 | Std | Std |
| C36 | 1 | Capacitor, ceramic, 270 pF, 50 V, X7R, $\pm 10\%$, 0805 | Std | Std |
| C37 | 1 | Capacitor, ceramic, 1200 pF, 50 V, C0G, $\pm 5\%$, 0805 | Std | Std |
| C38 | 1 | Capacitor, ceramic, 4.7 nF, 50 V, X7R, $\pm 10\%$, 0805 | Std | Std |
| C39 | 1 | Capacitor, ceramic, 1000 pF, 50 V, NP0, $\pm 5\%$, 0805 | Std | Std |
| C40 | 1 | Capacitor, ceramic, 0.18 μ F, 16 V, X7R, $\pm 10\%$, 0805 | Std | Std |
| C41 | 1 | Capacitor, ceramic, 0.39 μ F, 25 V, X7R, $\pm 10\%$, 0805 | Std | Std |
| C42 | 1 | Capacitor, ceramic, 0.18 μ F, 25 V, X7R, $\pm 10\%$, 0805 | Std | Std |
| C44 | 1 | Capacitor, ceramic, 2.2 μ F, 25 V, X5R, $\pm 10\%$, 0805 | Std | Std |
| C46, C47 | 2 | Capacitor, POSCAP, 330 μ F, 4 V, 12 m Ω , $\pm 20\%$, 7343 (D) | Sanyo | 4TPD330M |
| D1, D6, D8 | not used | not used, SOT-23 | | |
| D2, D7 | 2 | Diode, ultrafast rectifier, 1 A, 200 V, SMB | On Semiconductor | MURS120T3 |
| D3, D4, D5, D9, D10, D11, D15, D16, D20 | 9 | Diode, switching, 600 mA, 85 V, 350 mW, SOT-23 | Fairchild Semiconductor | BAS16 |
| D12, D14, D17, D18, D19 | 5 | Diode, schottky, 1.16 A, 40 V, SOT-23 | Zetex | ZLLS1000 |
| D13 | 1 | Diode, zener, 6.8 V, 350 mW, SOT-23 | Diodes Inc. | BZX84C6V8-7 |
| L1 | 1 | Inductor, SMT, 1.5 μ H, 21 A, 0.78 m Ω , 0.770 x 0.780 | Pulse | PA1292.152 |
| L2 | 1 | Inductor, SMT, 2.2 μ H, 12 A, 6.1 m Ω , 0.730 x 0.600 | Coilcraft | DO5010P-222HC |
| Q1, Q3 | 2 | MOSFET, N-channel, 150 V, 5 A, 50 m Ω , SO-8 | Vishay-Siliconix | Si4488DY |
| Q2 | not used | not used, | | |

| | | | | |
|-----------------------------|----------|---|-------------------------|-----------------------|
| Q4, Q5 | 2 | MOSFET, N-channel, 60 V, 115 mA, SOT-23 | Std | 2N7002 |
| Q6, Q15 | 2 | Transistor, NPN, 40 V, 1 A, SOT-23 | Fairchild Semiconductor | MMBT2222A |
| Q7, Q9 | 2 | Bipolar, NPN, 40 V, 200 mA, 350 mW, SOT-23 | Std | MMBT3904 |
| Q8, Q10 | 2 | Bipolar, PNP, -40 V, 200 mA, SOT-23 | Std | MMBT3906 |
| Q11, Q12, Q13, Q14 | 4 | MOSFET, N-channel, 20 V, 16 A, 6.5 mΩ, SO-8 | International Rectifier | IRF7456 |
| Q16 | 1 | MOSFET, N-channel, V _{DS} 30 V, R _{DS} 13.9 mΩ, I _d 30 A, LFPK | Hitachi | HAT2168H |
| Q17 | 1 | MOSFET, N-channel, V _{DS} 30 V, R _{DS} 3.3 mΩ, I _d 55 A, LFPK | Hitachi | HAT2165H |
| R1, R25, R26 | 3 | Resistor, chip, 1 kΩ, 1/16 W, ±1%, 0603 | Std | Std |
| R2 | 1 | Resistor, chip, 26.1 kΩ, 1/16 W, ±1%, 0603 | Std | Std |
| R3 | 1 | Resistor, chip, 84.5 kΩ, 1/16 W, ±1%, 0603 | Std | Std |
| R4 | 1 | Resistor, chip, 5.1 kΩ, 1/16 W, ±1%, 0805 | Std | Std |
| R5 | 1 | Resistor, chip, 9.09 kΩ, 1/8 W, ±1%, 1206 | Std | Std |
| R6, R15 | 2 | Resistor, chip, 1 Ω, 1/10 W, ±1%, 0805 | Std | Std |
| R7, R10, R11, R12, R16, R18 | not used | not used, 0603 | | |
| R8 | 1 | Resistor, chip, 0.08 Ω, 1W, ±1%, 2512 | Dale | WSL-2512-0.08 1% |
| R9, R14 | 2 | Resistor, chip, 549 Ω, 1/16 W, ±1%, 0603 | Std | Std |
| R13, R17 | 2 | Resistor, chip, 27 kΩ, 1 W, ±1%, 2512 | Dale | CRCW25122672F |
| R19 | 1 | Resistor, chip, 20 Ω, 1/16 W, ±1%, 0603 | Std | Std |
| R20 | 2 | Resistor, chip, 20 Ω, 1/8 W, ±1%, 1206 | Std | Std |
| R21, R22, R23, R24 | 4 | Resistor, chip, 511 Ω, 1/16 W, ±1%, 0603 | Std | Std |
| R27, R51 | 2 | Resistor, chip, 49.9 Ω, 1/10 W, ±1%, 0805 | Std | Std |
| R28 | 1 | Resistor, chip, 3.09 kΩ, 1/16 W, ±1%, 0603 | Std | Std |
| R29 | 1 | Resistor, chip, 1.87 kΩ, 1/16 W, ±1%, 0603 | Std | Std |
| R30 | 1 | Resistor, chip, 499 Ω, 1/10 W, ±1%, 0805 | Std | Std |
| R31 | 1 | Resistor, chip, 750 Ω, 1/10 W, ±1%, 0805 | Std | Std |
| R32, R39, R43, R46, R47 | 5 | Resistor, chip, 10 kΩ, 1/10 W, ±1%, 0805 | Std | Std |
| R33 | 1 | Resistor, chip, 30 kΩ, 1/10 W, ±1%, 0805 | Std | Std |
| R35 | 1 | Resistor, chip, 44.2 kΩ, 1/10 W, ±1%, 0805 | Std | Std |
| R36 | 1 | Resistor, chip, 1.37 kΩ, 1/10 W, ±1%, 0805 | Std | Std |
| R37 | 1 | Resistor, chip, 15 kΩ, 1/10 W, ±1%, 0805 | Std | Std |
| R38 | 1 | Resistor, chip, 29.4 kΩ, 1/10 W, ±1%, 0805 | Std | Std |
| R40 | 1 | Resistor, chip, 3.48 kΩ, 1/10 W, ±1%, 0805 | Std | Std |
| R41 | 1 | Resistor, chip, 634 Ω, 1/10 W, ±1%, 0805 | Std | Std |
| R42 | 1 | Resistor, chip, 20 Ω, 1/10 W, ±1%, 0805 | Std | Std |
| R44, R45, R48 | 3 | Resistor, chip, 0 Ω, 1/10 W, ±1%, 0805 | Std | Std |
| R49 | 1 | Resistor, chip, 25.5 Ω, 1/4 W, ±1%, 1206 | Std | Std |
| R50 | 1 | Resistor, metal strip, 0.005 Ω, 1 W, ±1%, 2512 | Vishay Dale | WSL-2512 0.005 ±1% |
| R52 | 1 | Resistor, chip, 1 kΩ, 1/10 W, ±1%, 0805 | Std | Std |
| T1 | 1 | Transformer, gate drive, 3950 μH, 1500 V _{DC} isolation, 0.340 x 0355 | Pulse | PA0510 |
| T2 | 1 | Transformer, 3 Primary, 2 Secondary, push pull, 1160 x 1524 | Pulse | PB2124 |

| | | | | |
|--|----|---|--------------------|-------------------------|
| U1** | 1 | IC, Current Mode Push-Pull PWM Controller, SO-8 | Texas Instruments | UCC38083D |
| U2** | 1 | IC, MOSFET Driver, Dual Channel Buffer w/Regulator, SO-8 | Texas Instruments | TPS2812D |
| U3 | 1 | IC, Optocoupler, 5300 V, 50 to 600% CTR, 0.380 x 0.180 | QT Optoelectronics | H11A817 |
| U4 | 1 | IC, Adj Shunt Regulator, 100 mA, 36 V, SO-8 | Texas Instruments | TLV431AID |
| U5** | 1 | IC, High-Efficiency Secondary-Side Synchronous Buck PWM Controller, PWP20 | Texas Instruments | UCC2540PWP |
| -- | | PCB, 6 In x 5 In x 0.062 In, | Any | HPA054A |
| J1, J2, J3, J4, J6, J7 | 6 | Connector, banana jack, uninsulated, 0.500 dia | Pomona | 3267 |
| J5 | 1 | Miniature Thru-hole mount test point, white, 0.040 | Keystone | 5002 |
| TP1, TP2, TP3, TP4, TP5, TP6, TP7, TP8, TP9, TP10, TP11, TP32, TP33 | 14 | Thru-hole mount test point, 0.043 hole, 0.043 dia | Mill-Max | 3103-1-00-15-00-00-0X-0 |
| TP13, TP14, TP16, TP17, TP18, TP19, TP20, TP21, TP22, TP23, TP28, TP29, TP30, TP31, TP34, TP35 | 16 | Miniature Thru-hole mount test point, white, 0.040 dia. | Keystone | 5002 |
| TP15, TP24, TP25, TP26 | 4 | Test point, SMT, 0.105 x 0.040 | Keystone | 5015 |
| TP27 | 1 | Adaptor, 3.5-mm probe clip (or 131-5031-00), 0.2 | Tektronix | 131-4244-00 |

- NOTES:
1. These assemblies are ESD sensitive, ESD precautions shall be observed.
 2. These assemblies must be clean and free from flux and all contaminants. Use of no clean flux is not acceptable.
 3. These assemblies must comply with workmanship standards IPC-A-610 Class 2.
 4. Ref designators marked with an asterisk (***) cannot be substituted. All other components can be substituted with equivalent MFG's components.

12 References

1. Data Sheet, *UCC2540 High-Efficiency Secondary-Side Synchronous Buck PWM Controller*, Texas Instruments Literature Number SLUS539
2. Data Sheet, *UCC38083 8-Pin Current Mode Push-Pull PWM Controllers With Programmable Slope Compensation*, Texas Instruments Literature Number SLUS488B
3. Bottrill, John, *50-W Push-Pull Converter Reference Design Using the UCC38083*, Texas Instruments Literature Number SLUU135A

IMPORTANT NOTICE

Texas Instruments Incorporated and its subsidiaries (TI) reserve the right to make corrections, modifications, enhancements, improvements, and other changes to its products and services at any time and to discontinue any product or service without notice. Customers should obtain the latest relevant information before placing orders and should verify that such information is current and complete. All products are sold subject to TI's terms and conditions of sale supplied at the time of order acknowledgment.

TI warrants performance of its hardware products to the specifications applicable at the time of sale in accordance with TI's standard warranty. Testing and other quality control techniques are used to the extent TI deems necessary to support this warranty. Except where mandated by government requirements, testing of all parameters of each product is not necessarily performed.

TI assumes no liability for applications assistance or customer product design. Customers are responsible for their products and applications using TI components. To minimize the risks associated with customer products and applications, customers should provide adequate design and operating safeguards.

TI does not warrant or represent that any license, either express or implied, is granted under any TI patent right, copyright, mask work right, or other TI intellectual property right relating to any combination, machine, or process in which TI products or services are used. Information published by TI regarding third-party products or services does not constitute a license from TI to use such products or services or a warranty or endorsement thereof. Use of such information may require a license from a third party under the patents or other intellectual property of the third party, or a license from TI under the patents or other intellectual property of TI.

Reproduction of information in TI data books or data sheets is permissible only if reproduction is without alteration and is accompanied by all associated warranties, conditions, limitations, and notices. Reproduction of this information with alteration is an unfair and deceptive business practice. TI is not responsible or liable for such altered documentation.

Resale of TI products or services with statements different from or beyond the parameters stated by TI for that product or service voids all express and any implied warranties for the associated TI product or service and is an unfair and deceptive business practice. TI is not responsible or liable for any such statements.

Following are URLs where you can obtain information on other Texas Instruments products and application solutions:

| Products | | Applications | |
|------------------|--|---------------------|--|
| Amplifiers | amplifier.ti.com | Audio | www.ti.com/audio |
| Data Converters | dataconverter.ti.com | Automotive | www.ti.com/automotive |
| DSP | dsp.ti.com | Broadband | www.ti.com/broadband |
| Interface | interface.ti.com | Digital Control | www.ti.com/digitalcontrol |
| Logic | logic.ti.com | Military | www.ti.com/military |
| Power Mgmt | power.ti.com | Optical Networking | www.ti.com/opticalnetwork |
| Microcontrollers | microcontroller.ti.com | Security | www.ti.com/security |
| | | Telephony | www.ti.com/telephony |
| | | Video & Imaging | www.ti.com/video |
| | | Wireless | www.ti.com/wireless |

Mailing Address: Texas Instruments
Post Office Box 655303 Dallas, Texas 75265