

# Using the UCC272xxEVM-328

## User's Guide



Literature Number: SLUUBJ7  
December 2016

## **Using the UCC27212EVM-328 and UCC27201AEVM-328**

---

---

---

### **Cautions and Warnings**

**CAUTION:**



**Caution! Do not leave EVM powered when unattended.**

**HOT SURFACE:**



**Caution Hot Surface! Contact may cause burns. Do not touch. Please take the proper precautions when operating.**

**HIGH VOLTAGE:**



**Danger High Voltage! Electric shock possible when connecting board to live wire. Board should be handled with care by a professional. For safety, use of isolated test equipment with overvoltage/overcurrent protection is highly recommended.**

---

**General Texas Instruments High Voltage Evaluation (TI HV EMV) User Safety Guidelines**

Always follow TI's set-up and application instructions, including use of all interface components within their recommended electrical rated voltage and power limits. Always use electrical safety precautions to help ensure your personal safety and those working around you. Contact TI's Product Information Center <http://ti.com/support> for further information.

**Save all warnings and instructions for future reference.**

**WARNING**

**Failure to follow warnings and instructions may result in personal injury, property damage or death due to electrical shock and burn hazards.**

The term TI HV EVM refers to an electronic device typically provided as an open framed, unenclosed printed circuit board assembly. It is *intended strictly for use in development laboratory environments, solely for qualified professional users having training, expertise and knowledge of electrical safety risks in development and application of high voltage electrical circuits. Any other use and/or application are strictly prohibited by Texas Instruments.* If you are not suitable qualified, you should immediately stop from further use of the HV EVM.

**1. Work Area Safety:**

- (a) Keep work area clean and orderly.
- (b) Qualified observer(s) must be present anytime circuits are energized.
- (c) Effective barriers and signage must be present in the area where the TI HV EVM and its interface electronics are energized, indicating operation of accessible high voltages may be present, for the purpose of protecting inadvertent access.
- (d) All interface circuits, power supplies, evaluation modules, instruments, meters, scopes, and other related apparatus used in a development environment exceeding 50Vrms/75VDC must be electrically located within a protected Emergency Power Off EPO protected power strip.
- (e) Use stable and non-conductive work surface.
- (f) Use adequately insulated clamps and wires to attach measurement probes and instruments. No freehand testing whenever possible.

**2. Electrical Safety:**

As a precautionary measure, it is always good engineering practice to assume that the entire EVM may have fully accessible and active high voltages.

- (a) De-energize the TI HV EVM and all its inputs, outputs and electrical loads before performing any electrical or other diagnostic measurements. Revalidate that TI HV EVM power has been safely de-energized.
- (b) With the EVM confirmed de-energized, proceed with required electrical circuit configurations, wiring, measurement equipment hook-ups and other application needs, while still assuming the EVM circuit and measuring instruments are electrically live.
- (c) Once EVM readiness is complete, energize the EVM as intended.

**WARNING**

While the EVM is energized, never touch the EVM or its electrical circuits, as they could be at high voltages capable of causing electrical shock hazard.

**3. Personal Safety**

- (a) Wear personal protective equipment e.g. latex gloves or safety glasses with side shields or protect EVM in an adequate lucent plastic box with interlocks from accidental touch.

**Limitation for safe use:**

EVMs are not to be used as all or part of a production unit.

# Using the UCC27212EVM-328 and UCC27201AEVM-328

---

---

---

## 1 Introduction

UCC27212EVM-328 and UCC27201AEVM-328 is the evaluation module designed to primarily evaluate UCC27212 and UCC27201A performance. The same board can be used to evaluate other pin to pin compatible parts in the supported package. These drivers are 120-V boot voltage, high-side and low-side driver with high source and sink peak currents for driving two N-Channel MOSFETs. The board is developed in such a way that multiple converter topologies such as half-bridge and high voltage synchronous buck can be configured out of it. The UCC272xx's low pullup and pulldown resistance allows for driving large power MOSFETs with minimized switching losses during the transition through the Miller Plateau of the MOSFET. The input of these devices can handle negative voltage which increases robustness and also allows direct interface to gate-drive transformers without using rectification diodes. The inputs are also independent of supply voltage and have a 20-V maximum rating.

## 2 Description

The UCC272xx evaluation board has one screw terminal block that allows connection to the input or bus voltage, HV+, switch node, HS, and the ground, GND. It has three headers, one for the high-side PWM input, one for the low-side PWM input and the third one for the power supply of the driver. This EVM also has a variety of testing points to easily analyze most of the key features of UCC27212 and UCC27201A. As EVM need to incorporate various test points and MOSFET footprint that can accommodate a wide variety of MOSFETs, the layout is not optimal for very high power converter configurations. The guidelines for optimal layout can be found in the driver datasheet. User must install electrolytic capacitor at the input for any type of power testing. The board has ceramic capacitors at the input to facilitate no load testing of the topology such as synchronous buck. For detailed device information, please refer to [UCC27212 Datasheet](#) and [UCC27201A Datasheet](#).

### 2.1 Features

- Features UCC27201A or UCC27212 gate driver.
- 3 terminal block allows easy connection of high voltage input bus HV+, switch node, HS, and ground, GND.
- Easily configured into different topologies such as synchronous buck, synchronous boost, and half-bridge converter.
- Quickly check the effect of different external components such as bootstrap capacitor, bootstrap diode, gate resistor, gate diode, etc.
- Allows quick verification of most of the datasheet parameters.
- Open loop power stage allows user to quickly find out whether the application issues are driver related or related to other parameters in the application.
- Easily perform chip level tests by removing power MOSFETs and replacing gate resistors with 0- $\Omega$  resistor and replacing gate to source resistor with appropriate load capacitor.
- Power stage featuring 100 V, N-Channel MOSFETS.
- Features popular pinouts for FETs, D2PACK and TO-220.

## 2.2 I/O Description

**Table 1. Connection Descriptions**

CONNECTIONS	DESCRIPTION
J1	High voltage input HV+, high-side source HS, GND
Jext1	Positive power supply for the lower-gate driver VCC
Jext2	Low-side input LI
Jext3	High-side input HI

### 3 Electrical Specifications

**Table 2. UCC272xxEVM-328 Electrical Specifications**

CONNECTIONS	DESCRIPTION
J1	100 V max on HV+, 1 A max
Jext1	5-V-17-V VDD operating voltage range
Jext2	5-V to 17-V PWM signals
Jext3	5-V to 17-V PWM signals
QH1,QL1	N-channel,100 V

### 4 Test Setup

#### 4.1 Definitions

This procedure details how to configure the UCC27212 evaluation board. Within this test procedure the following naming conventions are followed. Refer to the UCC27212EVM schematic, [Figure 10](#) for details.

**DMM:** Digital Multi-Meters

**UUT:** Unit Under Test

**EVM:** Evaluation Module assembly, in this case the UUT

#### 4.2 Equipment

##### 4.2.1 Power Supplies

Two DC power supply with voltage/current above 25 V/1 A, for example: Agilent E3634A.

##### 4.2.2 Function Generators

One two-channel function generator over 20 MHz, for example, Tektronics AFG3252

## 4.3 Equipment Setup

### 4.3.1 DC Power Supply Settings

- DC power supply #1
  - Voltage setting: 10 V
  - Current limit: 0.05 A
- DC power supply #2
  - Voltage setting: 50 V
  - Current limit: 2.5 A



### 4.3.2 Digital Multi-Meter Settings

- Digital multi-meter #1
  - DC current measurement, auto-range. Expected current is within 1 mA to 15 mA
- Digital multi-meter #2
  - DC current measurement, auto-range, expected current is within 2 mA to 2.5 mA

### 4.3.3 Two-Channel Function Generator Settings

**Table 3. Two-Channel Function Generator Settings**

CHANNEL	MODE	FREQUENCY	DUTY CYCLE	DELAY	HIGH	LOW	OUTPUT IMPEDANCE
Channel A	Pulse	100 kHz	20%	0 ns	5 V	0 V	High Z
Channel B			70%	2.5 $\mu$ s			

### 4.3.4 Oscilloscope Setting

**Table 4. Oscilloscope Settings**

CHANNEL	BANDWIDTH	COUPLING	TERMINATION	SCALE SETTINGS	INVERTING
Channel A	500 MHz or above	DC	1 M $\Omega$ or automatic	10x or automatic	OFF
Channel B					

### 4.3.5 Bench Setup Diagram

The current bench setup diagram includes the function generator and oscilloscope connections.

Please follow the connection procedure below, and [Figure 1](#) can be used as a reference.

- Make sure all the output of the function generator, voltage source are disabled before connection.
- Function generator channel-A channel applied on Jext3/HI.
- 
- Function generator channel-B channel applied on Jext2/LI.
- Power supply #1: positive node connected to input of DMM#1 and DMM#1 output connected to Jext1 pin.
- Power supply #2: positive node connected to input of DMM #2 and DMM #2 output connected to J1 pin-3 (marked as HV), negative node of Power Supply #2 connected directly to J1 pin-1 (marked as GND).
- Connect oscilloscope Ch-1 probes to test points marked as HO↔GND, smaller measurement loop is preferred.
- Connect oscilloscope Ch-2 probes to test points marked as HS↔GND, smaller measurement loop is preferred.
- Connect oscilloscope Ch-3 probes to test points marked as LO↔GND, smaller measurement loop is preferred.

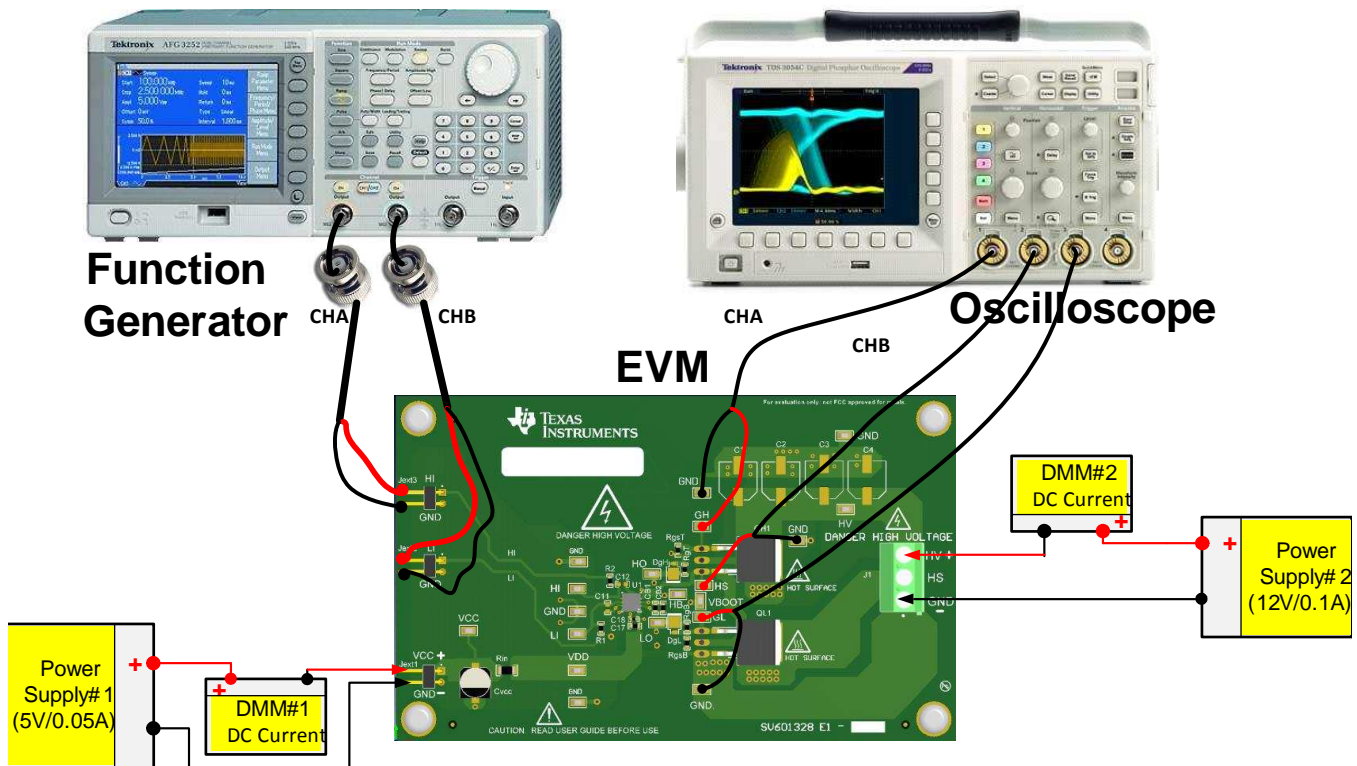

Figure 1. Bench Setup Diagram and Configuration

## 5 Power Up and Power Down Procedure

### 5.1 Power Up

1. Before preceding the power-up test procedure, please make sure that [Figure 1](#) is implemented for setting up all the equipment. [Figure 1](#) could be used as reference
2. Enable supply #1.
3. Enable supply #2, if the current on DMM1 is less than 2 mA and current in DMM2 is less than 2 mA, it is normal operation and can proceed to next step. Otherwise, the EVM fails.
4. Enable function generator two channel output channel-A and channel-B.
5. There will be:
  - (a) Stable pulse output on the channel-A, channel-B, and channel-C on the oscilloscope.
  - (b) Frequency measurement should 100 kHz  $\pm$  2 kHz.
  - (c) DMM #1 should read measurement 11 mA,  $\pm$  2 mA.

### 5.2 Power Down

1. Disable function generator.
2. Disable power supply #2.
3. Disable power supply #1.
4. Disconnect cables and probes.

## 6 Typical Performance Waveforms

### 6.1 Rise and Fall Times

Following waveforms could be observed with setup explained in [Section 4](#).

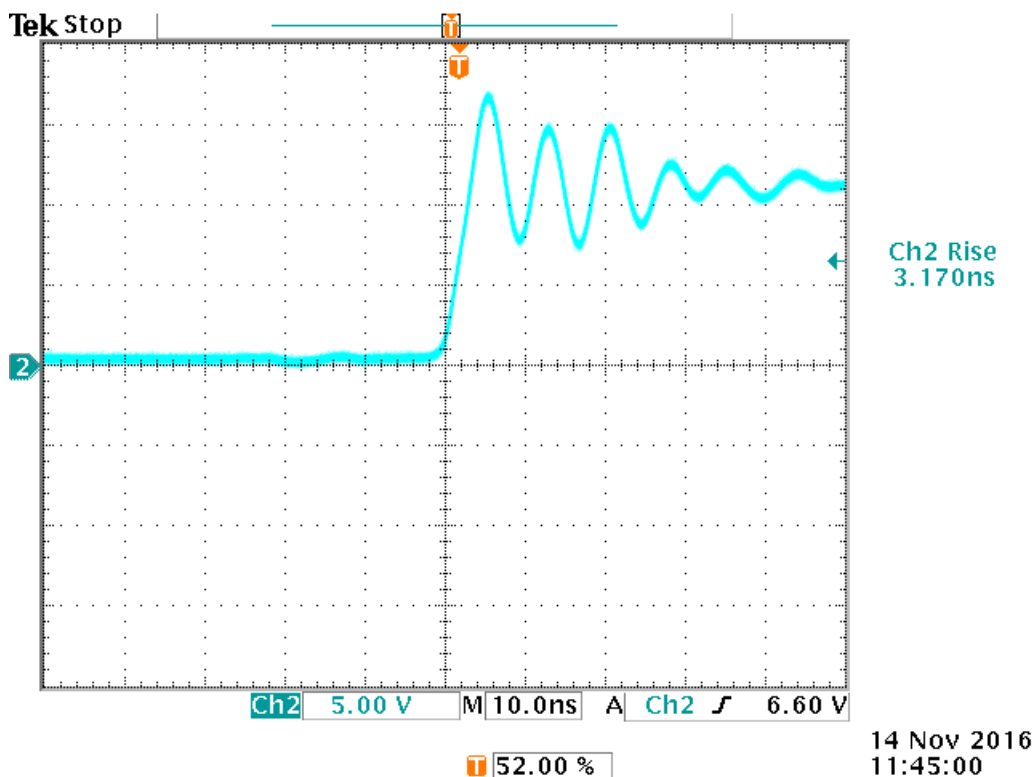

Figure 2. HO Rise Time

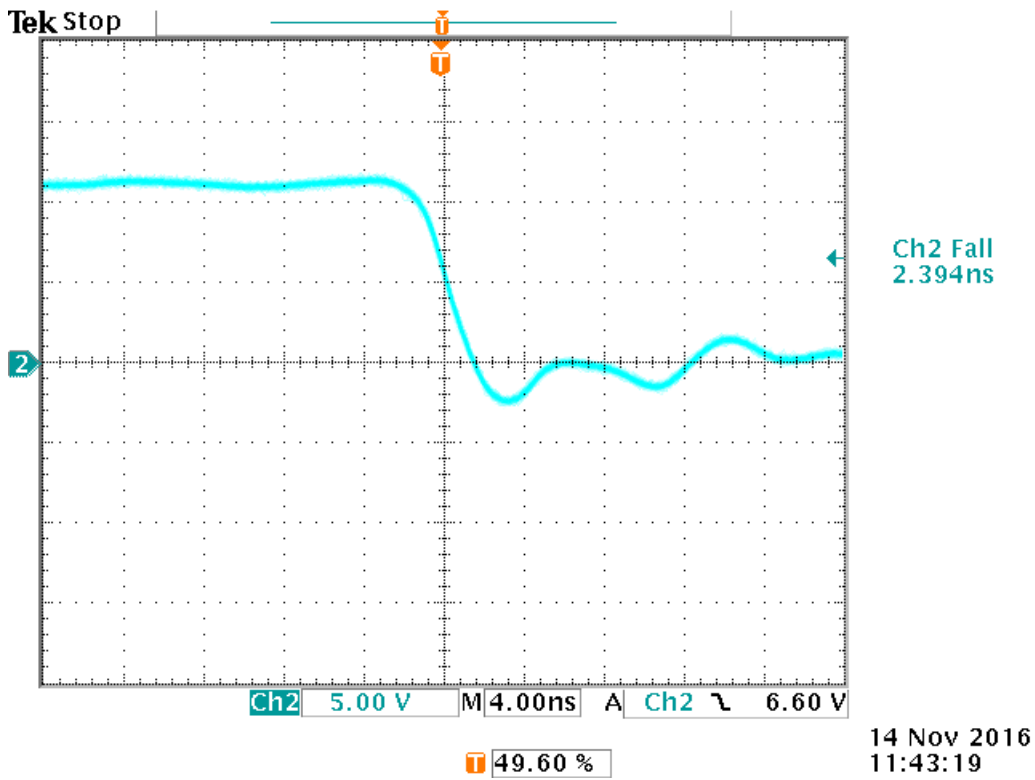

Figure 3. HO Fall Time

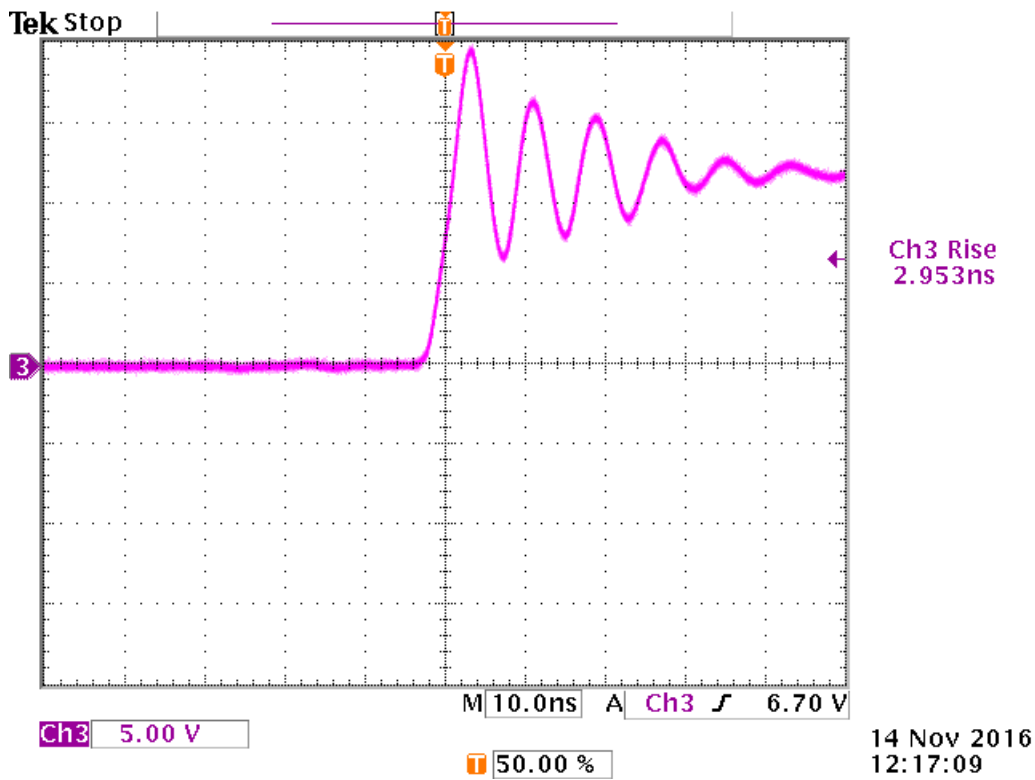

Figure 4. LO Rise Time

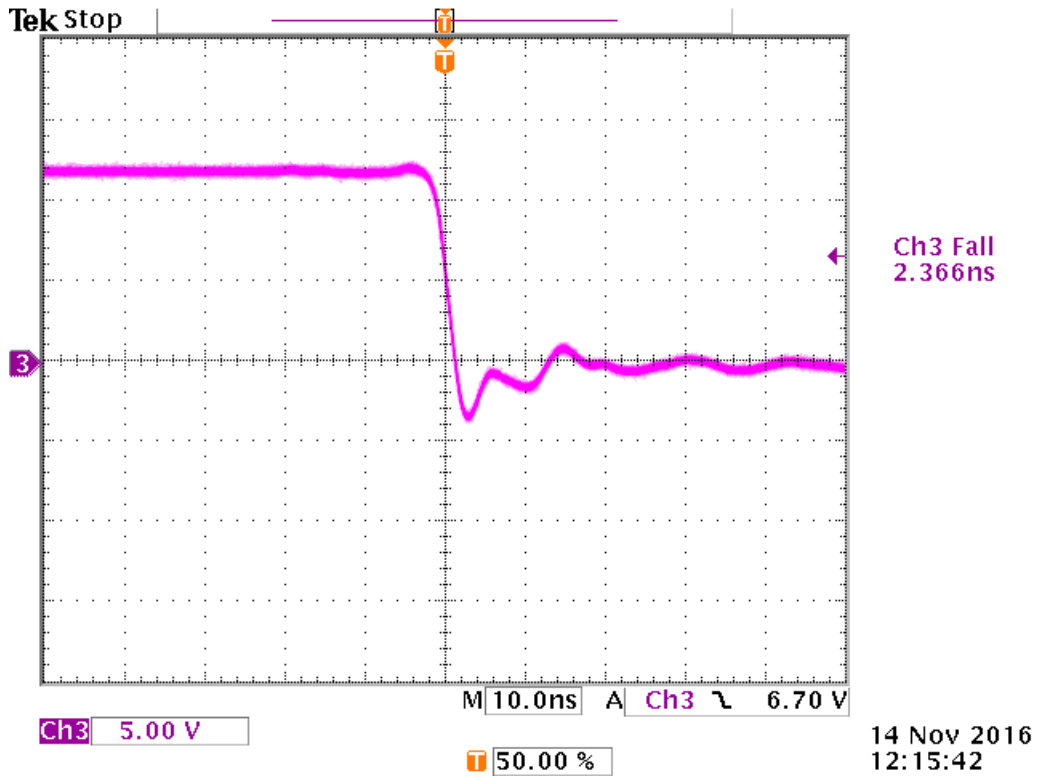

Figure 5. LO Fall Time

## 6.2 Propagation Delays

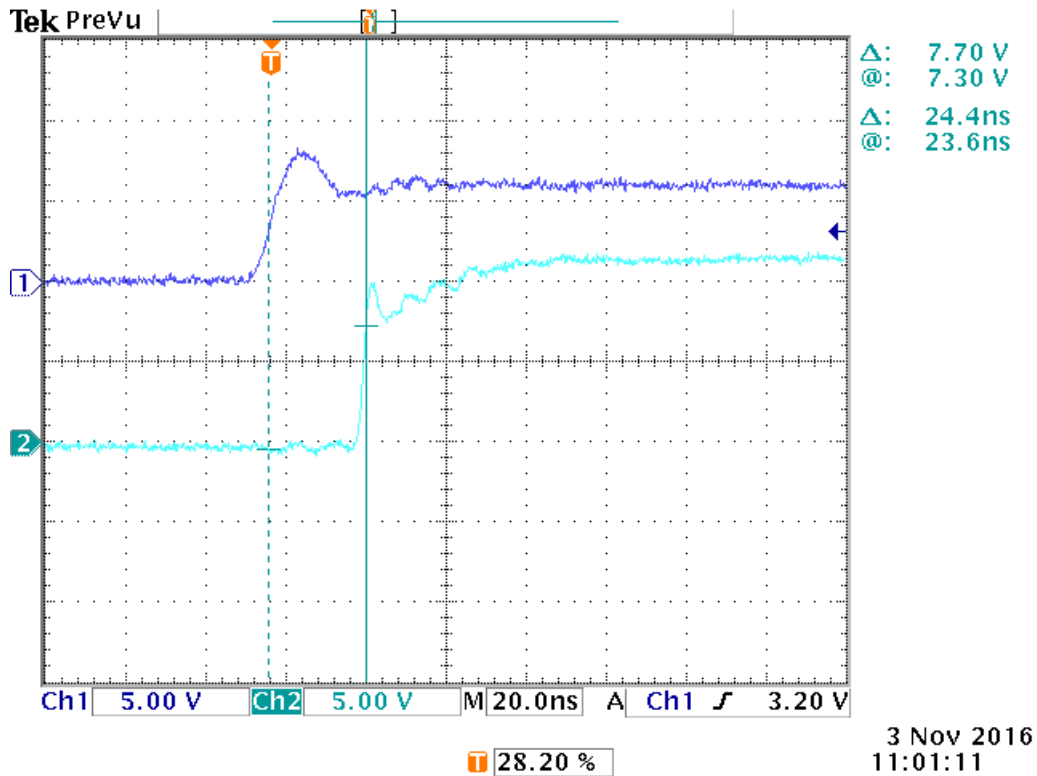

Figure 6. HI and HO Propagation Delay

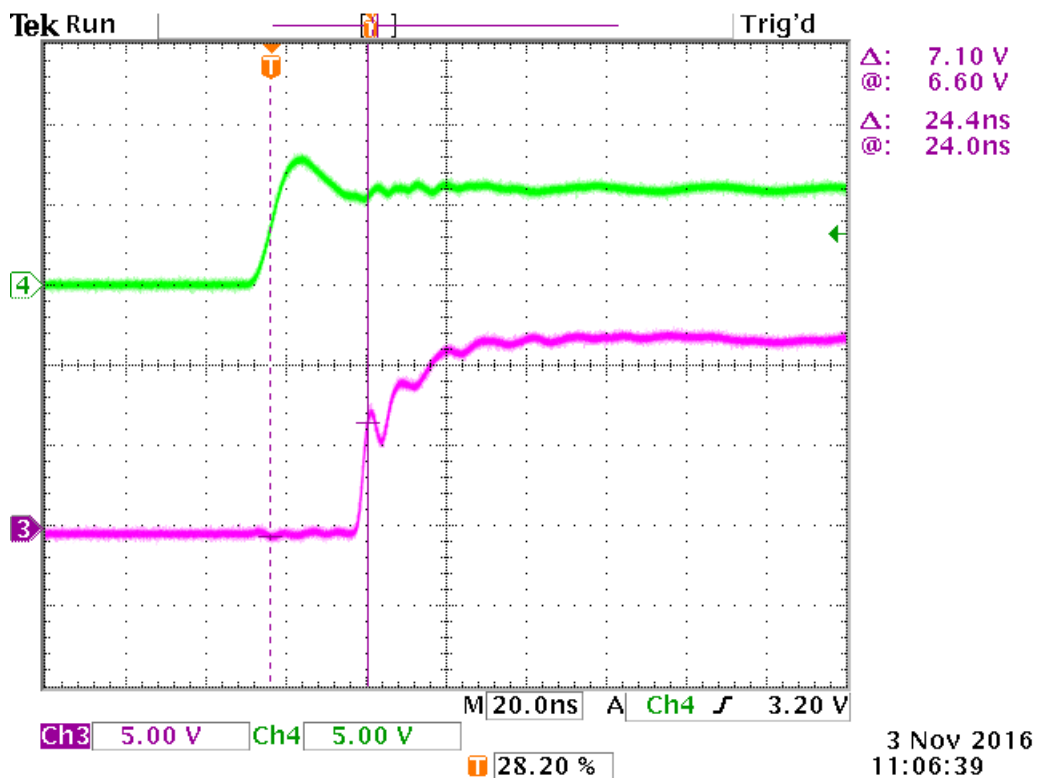

Figure 7. LI and LO Propagation Delay

### 6.3 Configuring UCC272xx EVM into a Synchronous Buck Converter

The UCC272xxEVM can easily be used to form a synchronous buck converter by connecting an inductor, capacitor and load to the EVM as shown in the diagram below. The inductor, capacitor, and load are not supplied with the EVM. Connect up to 100 V on the bus supply HV+; this will be the buck converter's input. The UCC272xxEVM brings its switch node out onto HS in order to connect external components.

For example, 48 V is a common bus voltage and it frequently needs to be bucked down to 24 V or 12 V. The board has been tested when configured as synchronous buck converter with a 100- $\mu$ H inductor and a 100- $\mu$ F capacitor are connected to the HS and GND connection point as shown in diagram below. Input voltage, output voltage, HO, and inductor current waveforms are shown in figures below. A film capacitor is recommended at the buck output for high frequency filtering.

One can notice the high frequency noise on the board. The buck converter design can be found in many publicly available literature. It should be noted that there is no heat-sink on the power MOSFET and therefore, for high power testing it is highly recommended that some sort of heat sink should be provided. Gate resistors can be increased to reduce the dv/dt related noise. The board has also provided placement option of external bootstrap capacitor to test effect of different types of bootstrap capacitors. Board does not come with input electrolytic capacitors installed, but it is highly recommended that user should install them. Board has provision if different source and sink capability is desired by choosing different gate resistor value and different diode-resistor values.

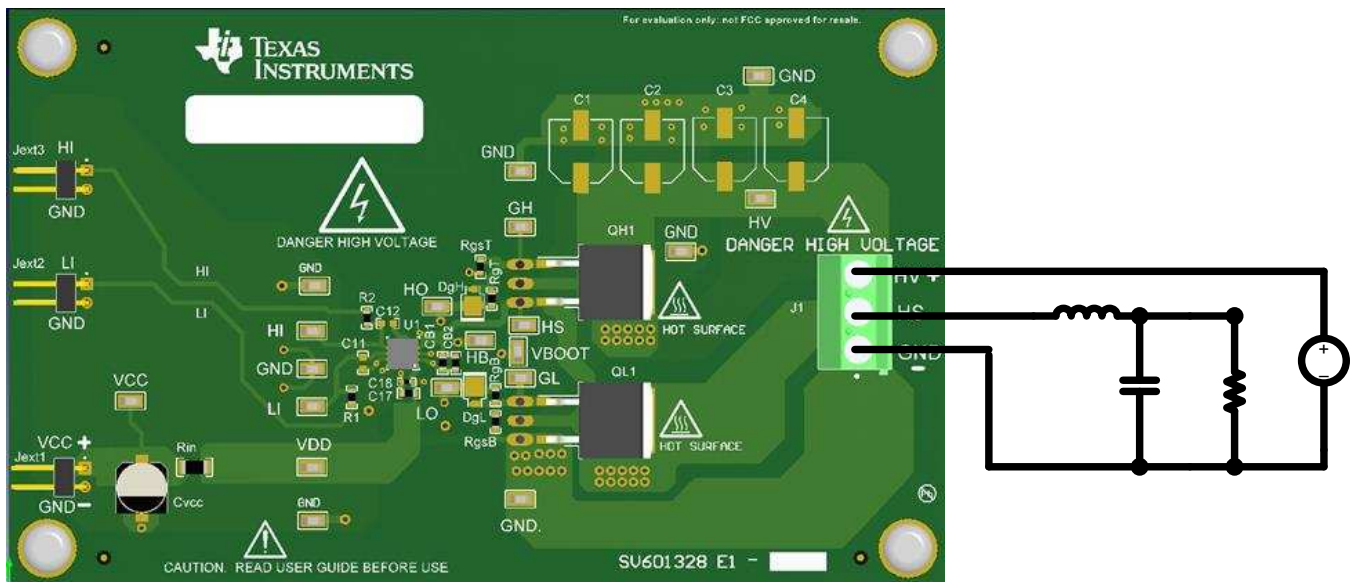

Figure 8. Buck Converter Example

Table 5. UCC27212 Parameters

PARAMETERS	VALUE
Output voltage ( $V_{OUT}$ )	12 V
Output current ( $I_{OUT}$ )	8 A
Input voltage ( $V_{IN}$ )	48 V
Switching frequency ( $f_{SW}$ )	100 kHz
$P_{O(max)}$	100 W

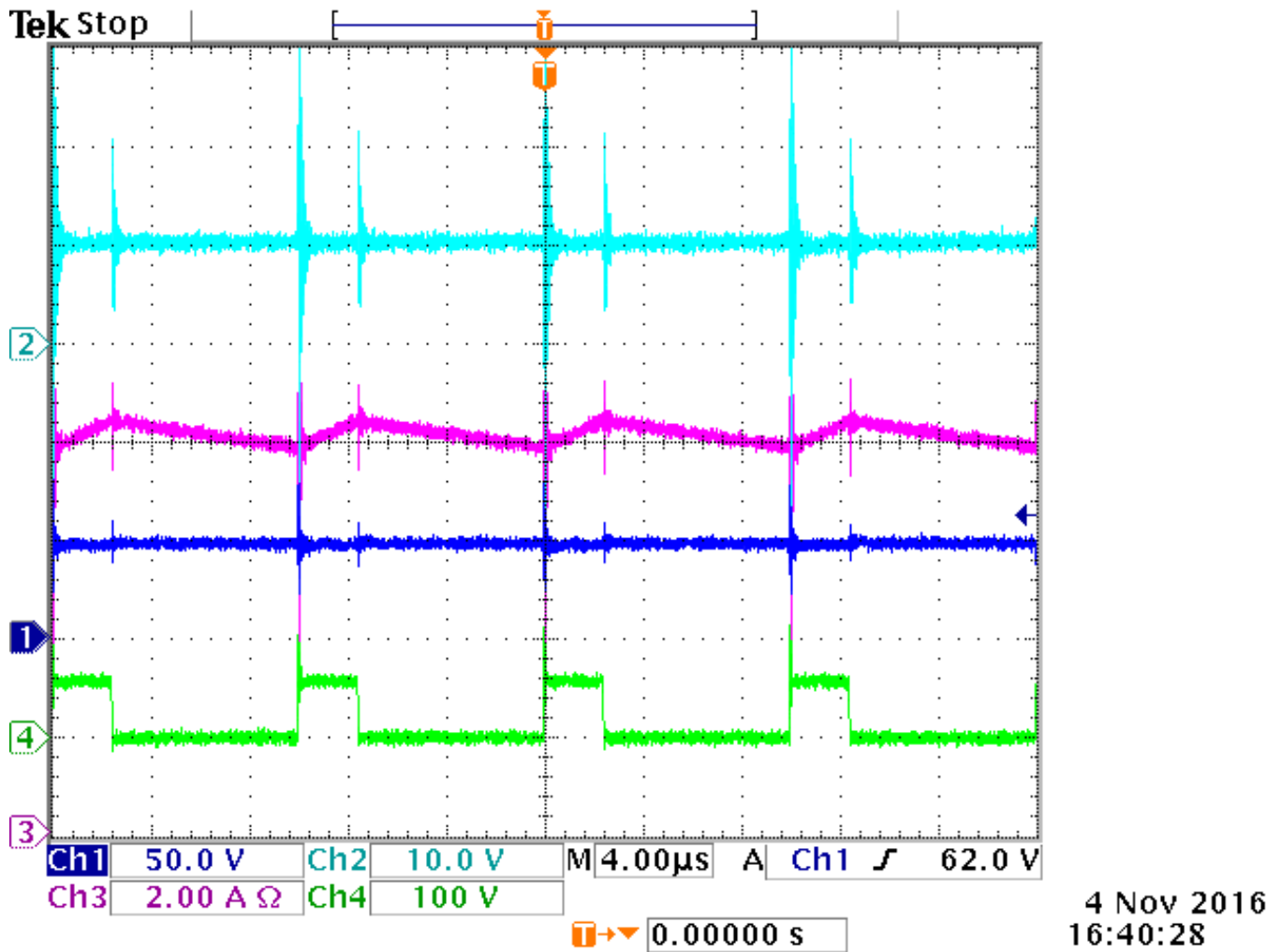

Figure 9. Buck Converter  $V_{IN}$ ,  $V_{OUT}$ ,  $I_L$ , and HO

Table 6. Waveforms Figure Channel Descriptions

CHANNEL	DESCRIPTION
CH 1	Input voltage
CH 2	Output voltage
CH 3	Inductor current
CH 4	HO



7 Schematic

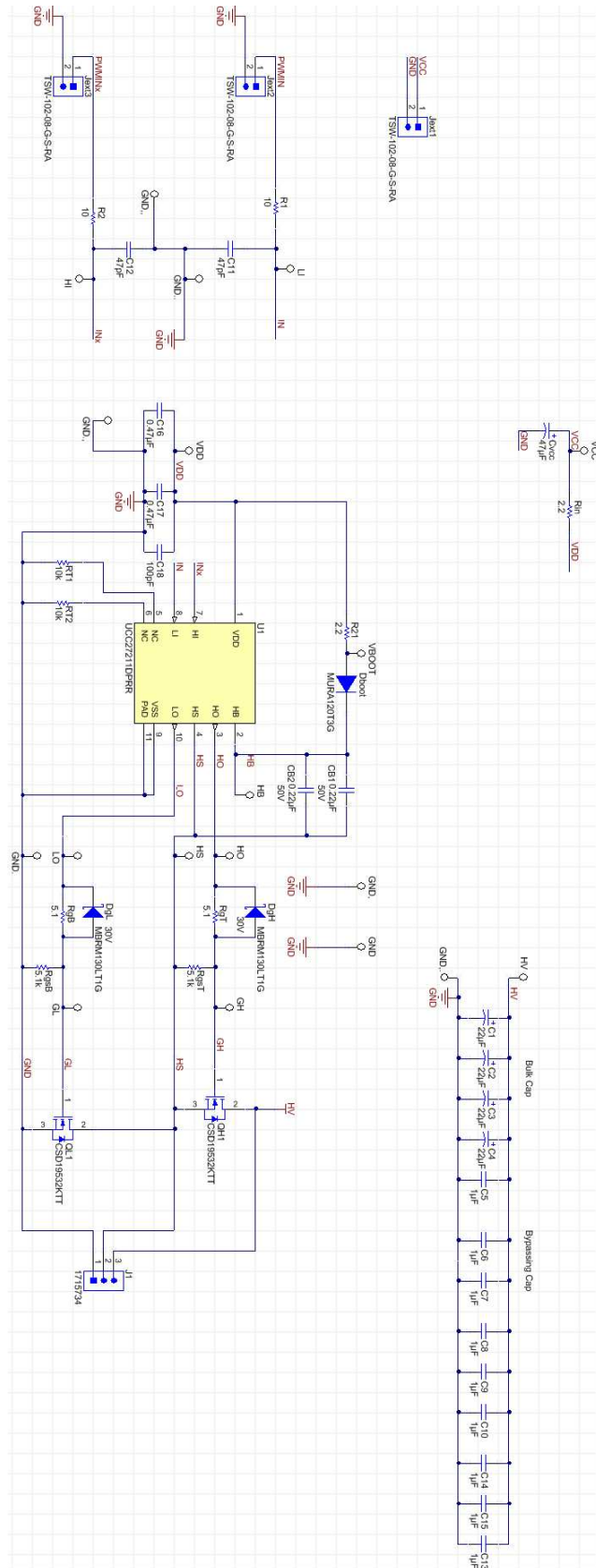

Figure 10. UCC272xx Schematic

## 8 Layout Diagrams

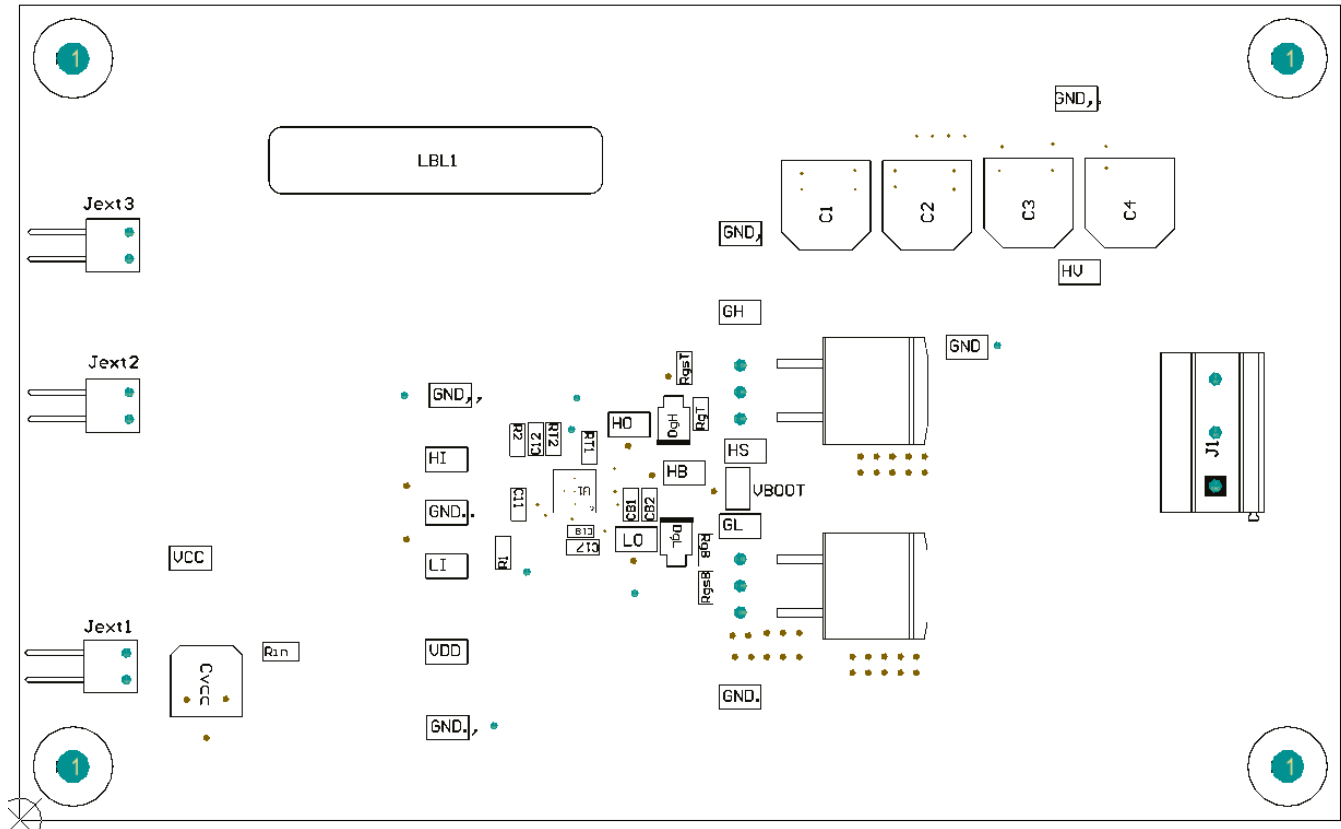

Figure 11. Assembly Top Layer

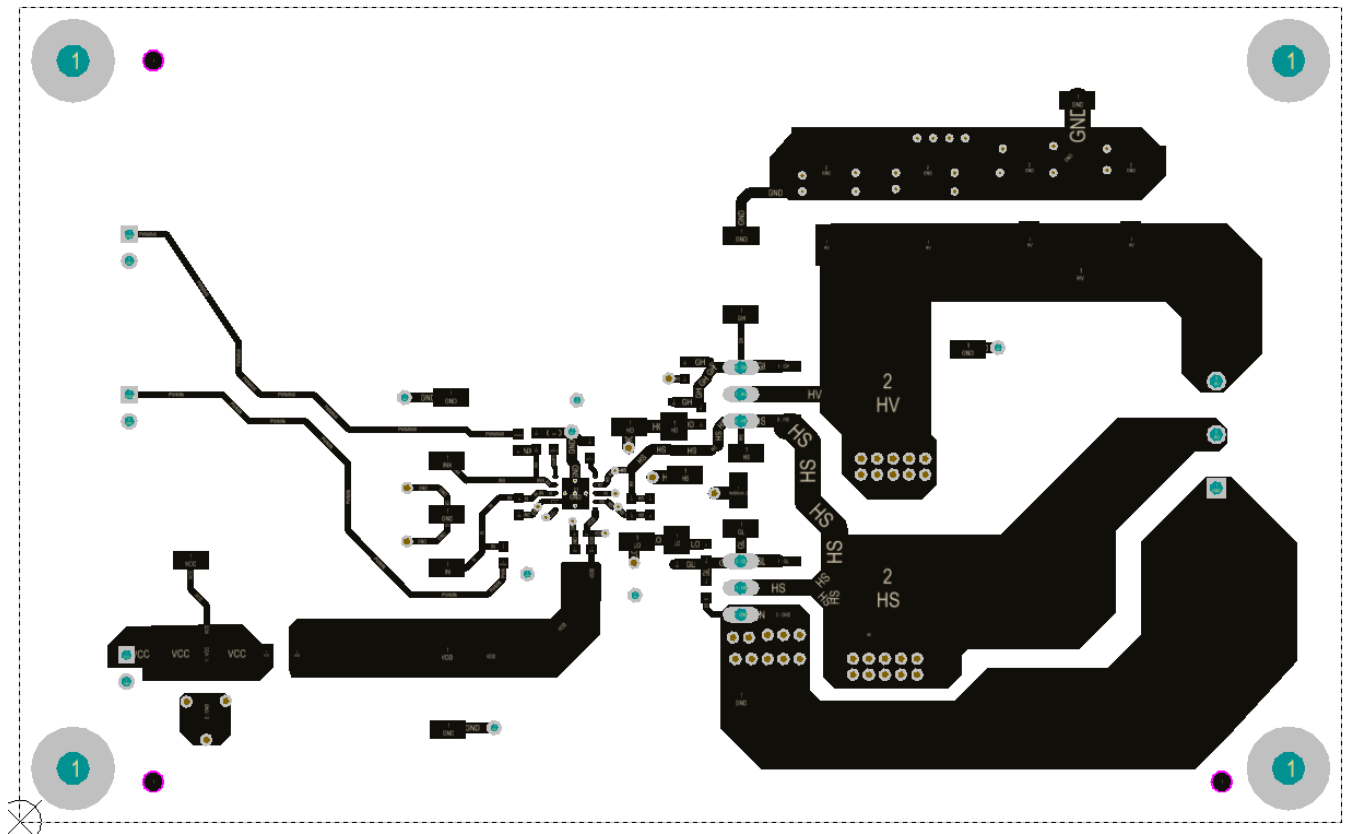

Figure 12. Top Layer

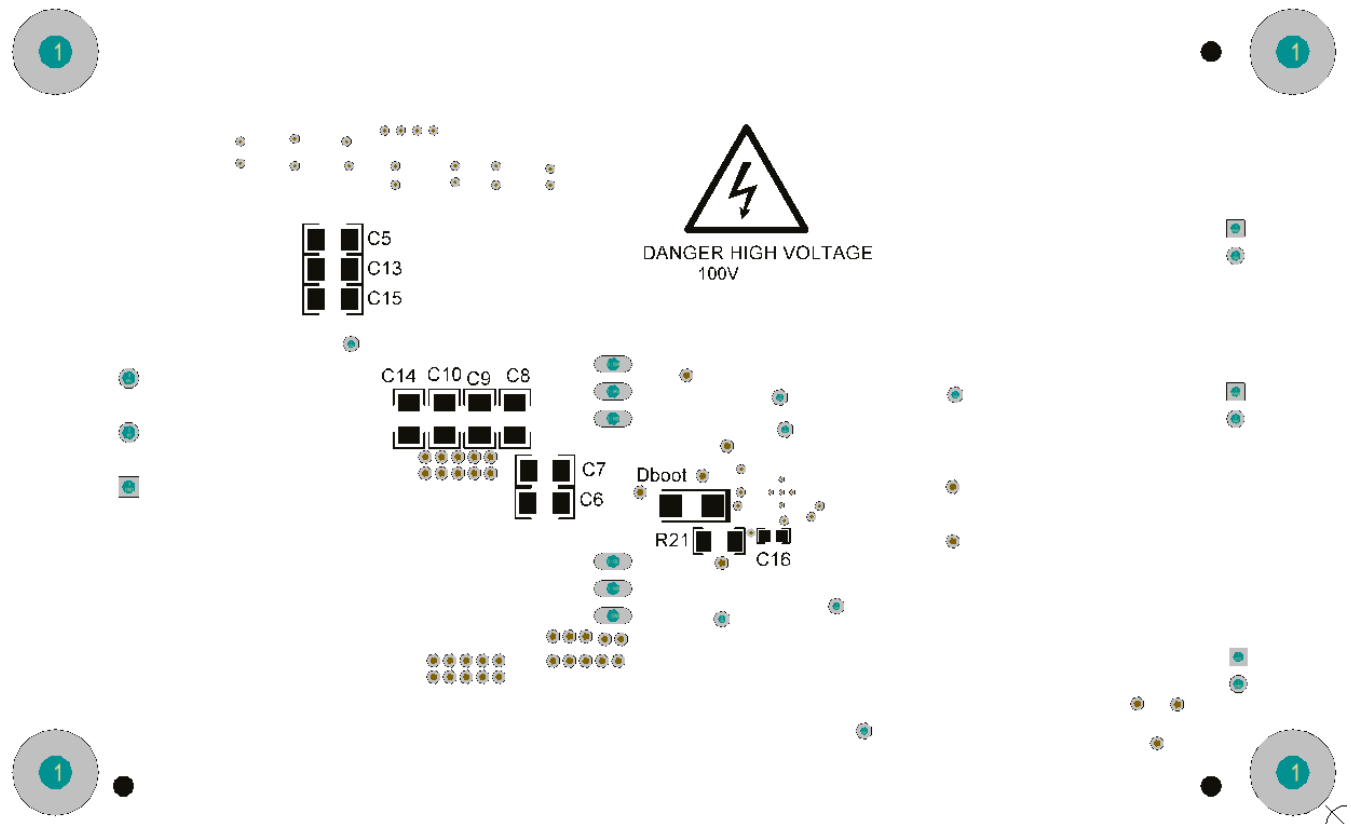

Figure 13. Bottom Overlay

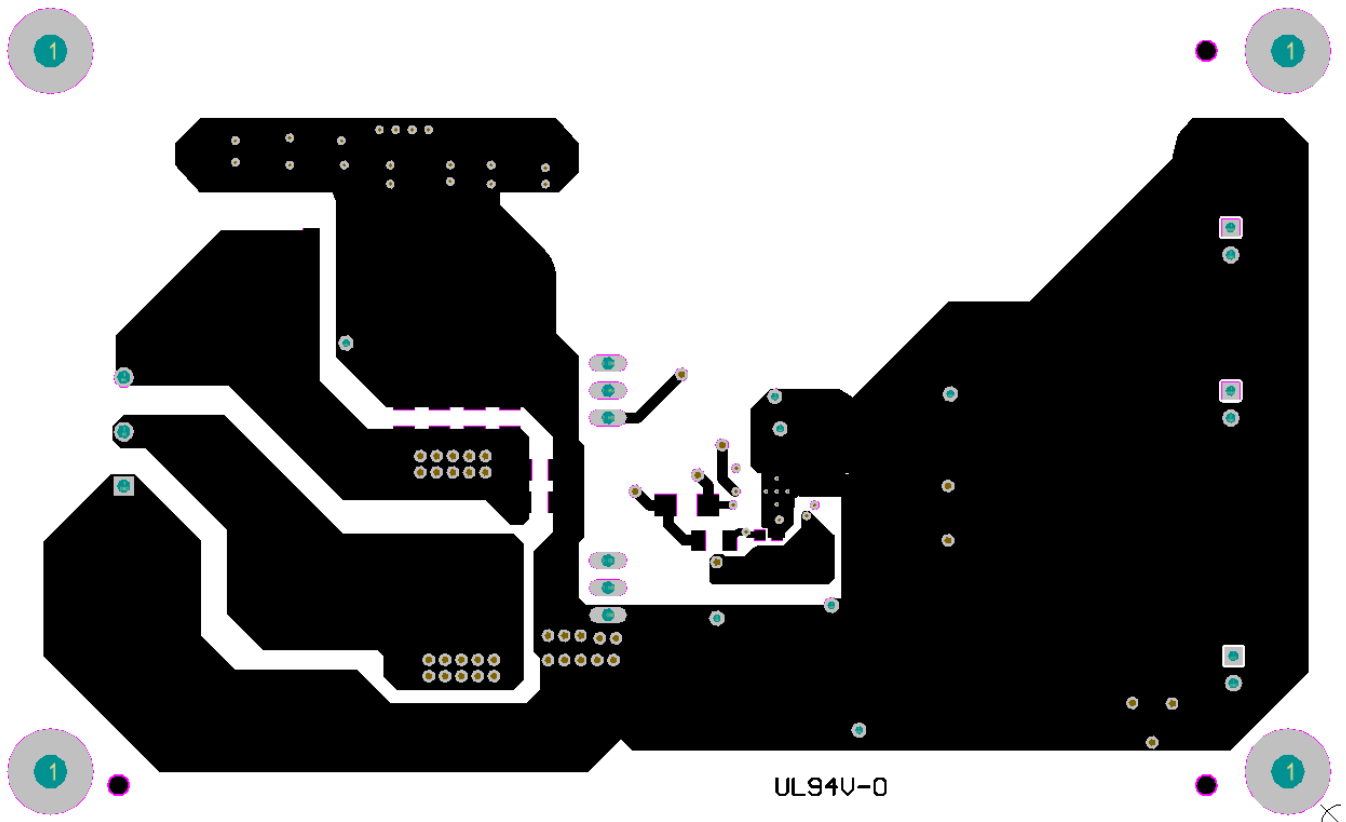

Figure 14. Bottom Layer

## 9 List of Materials

**Table 7. UCC272xxEVM-328 List of Materials**

QTY	DES	DESCRIPTION	MANUFACTURE	PART NUMBER
1	!PCB	Printed Circuit Board	Any	SV601328
4	C1, C2, C3, C4	Capacitor, aluminum, 22 $\mu$ F, 100 V, $\pm$ 20%, 1.3 $\Omega$ , SMD	Panasonic	EEE-FK2A220P
9	C5, C6, C7, C8, C9, C10, C13, C14, C15	Capacitor, ceramic, 1 $\mu$ F, 100 V, $\pm$ 10%, X7R, 1206	MuRata	GRM31CR72A105KA01 L
2	C11, C12	Capacitor, ceramic, 47 pF, 50 V, $\pm$ 5%, C0G/NP0, 0603	MuRata	GRM1885C1H470JA01 D
2	C16, C17	Capacitor, ceramic, 0.47 $\mu$ F, 50 V, $\pm$ 10%, X7R, 0603	TDK	C1608X7R1H474K080A C
1	C18	Capacitor, ceramic, 100 pF, 50 V, $\pm$ 5%, C0G/NP0, 0402	Wurth Elektronik	885012005061
2	CB1, CB2	Capacitor, ceramic, 0.22 $\mu$ F, 50 V, $\pm$ 10%, X7R, 0603	TDK	C1608X7R1H224K080A B
1	Cvcc	Capacitor, aluminum, 47 $\mu$ F, 50 V, $\pm$ 20%, 0.68 $\Omega$ , SMD	Nichicon	UUD1H470MCL1GS
1	Dboot	Diode, Ultrafast, 200 V, 1 A, SMA	ON Semiconductor	MURA120T3G
2	DgH, DgL	Diode, Schottky, 30 V, 1 A, powermite	ON Semiconductor	MBRM130LT1G
6	FID1, FID2, FID3, FID4, FID5, FID6	Fiducial mark. There is nothing to buy or mount.	N/A	N/A
19	GH, GL, GND, HB, HI, HO, HS, HV, LI, LO, VBOOT, VCC, VDD	Test point, miniature, SMT	Keystone	5015
4	H1, H2, H3, H4	Machine screw, round, #4-40 x 1/4, nylon, philips panhead	B&F Fastener Supply	NY PMS 440 0025 PH
4	H5, H6, H7, H8	Standoff, Hex, 0.5"L #4-40 Nylon	Keystone	1902C
1	J1	TERM BLOCK 3POS 5.08MM, TH	Phoenix Contact	1715734
3	Jext1, Jext2, Jext3	Header, 100 mil, 2x1, gold, R/A, TH	Samtec	TSW-102-08-G-S-RA
1	LBL1	Thermal transfer printable labels, 1.250" W x 0.250" H - 10,000 per roll	Brady	THT-13-457-10
2	QH1, QL1	MOSFET, N-channel, 100 V, 136 A, KTT0002A	Texas Instruments	CSD19532KTT
2	R1, R2	Resistor, 0 $\Omega$ , 5%, 0.1 W, 0603	Panasonic	ERJ-3GEY0R00V
2	R21, Rin	Resistor, 2.2 $\Omega$ , 5%, 0.25 W, 1206	Vishay-Dale	CRCW12062R20JNEA
2	RgB, RgT	Resistor, 5.1 $\Omega$ , 5%, 0.1 W, 0603	Vishay-Dale	CRCW06035R10JNEA
2	RgsB, RgsT	Resistor, 5.1 k $\Omega$ , 5%, 0.1 W, 0603	Vishay-Dale	CRCW06035K10JNEA
2	RT1, RT2	Resistor, 10 k $\Omega$ , 5%, 0.1 W, 0603	Vishay-Dale	CRCW060310K0JNEA
1	U1	120-V Boot, High Frequency High-Side and Low-Side Driver, DPR0010A (WSON-10)	Texas Instruments	UCC27211DPRR or UCC27201ADPR

## IMPORTANT NOTICE

Texas Instruments Incorporated and its subsidiaries (TI) reserve the right to make corrections, enhancements, improvements and other changes to its semiconductor products and services per JESD46, latest issue, and to discontinue any product or service per JESD48, latest issue. Buyers should obtain the latest relevant information before placing orders and should verify that such information is current and complete. All semiconductor products (also referred to herein as "components") are sold subject to TI's terms and conditions of sale supplied at the time of order acknowledgment.

TI warrants performance of its components to the specifications applicable at the time of sale, in accordance with the warranty in TI's terms and conditions of sale of semiconductor products. Testing and other quality control techniques are used to the extent TI deems necessary to support this warranty. Except where mandated by applicable law, testing of all parameters of each component is not necessarily performed.

TI assumes no liability for applications assistance or the design of Buyers' products. Buyers are responsible for their products and applications using TI components. To minimize the risks associated with Buyers' products and applications, Buyers should provide adequate design and operating safeguards.

TI does not warrant or represent that any license, either express or implied, is granted under any patent right, copyright, mask work right, or other intellectual property right relating to any combination, machine, or process in which TI components or services are used. Information published by TI regarding third-party products or services does not constitute a license to use such products or services or a warranty or endorsement thereof. Use of such information may require a license from a third party under the patents or other intellectual property of the third party, or a license from TI under the patents or other intellectual property of TI.

Reproduction of significant portions of TI information in TI data books or data sheets is permissible only if reproduction is without alteration and is accompanied by all associated warranties, conditions, limitations, and notices. TI is not responsible or liable for such altered documentation. Information of third parties may be subject to additional restrictions.

Resale of TI components or services with statements different from or beyond the parameters stated by TI for that component or service voids all express and any implied warranties for the associated TI component or service and is an unfair and deceptive business practice. TI is not responsible or liable for any such statements.

Buyer acknowledges and agrees that it is solely responsible for compliance with all legal, regulatory and safety-related requirements concerning its products, and any use of TI components in its applications, notwithstanding any applications-related information or support that may be provided by TI. Buyer represents and agrees that it has all the necessary expertise to create and implement safeguards which anticipate dangerous consequences of failures, monitor failures and their consequences, lessen the likelihood of failures that might cause harm and take appropriate remedial actions. Buyer will fully indemnify TI and its representatives against any damages arising out of the use of any TI components in safety-critical applications.

In some cases, TI components may be promoted specifically to facilitate safety-related applications. With such components, TI's goal is to help enable customers to design and create their own end-product solutions that meet applicable functional safety standards and requirements. Nonetheless, such components are subject to these terms.

No TI components are authorized for use in FDA Class III (or similar life-critical medical equipment) unless authorized officers of the parties have executed a special agreement specifically governing such use.

Only those TI components which TI has specifically designated as military grade or "enhanced plastic" are designed and intended for use in military/aerospace applications or environments. Buyer acknowledges and agrees that any military or aerospace use of TI components which have **not** been so designated is solely at the Buyer's risk, and that Buyer is solely responsible for compliance with all legal and regulatory requirements in connection with such use.

TI has specifically designated certain components as meeting ISO/TS16949 requirements, mainly for automotive use. In any case of use of non-designated products, TI will not be responsible for any failure to meet ISO/TS16949.

### Products

Audio	<a href="http://www.ti.com/audio">www.ti.com/audio</a>
Amplifiers	<a href="http://amplifier.ti.com">amplifier.ti.com</a>
Data Converters	<a href="http://dataconverter.ti.com">dataconverter.ti.com</a>
DLP® Products	<a href="http://www.dlp.com">www.dlp.com</a>
DSP	<a href="http://dsp.ti.com">dsp.ti.com</a>
Clocks and Timers	<a href="http://www.ti.com/clocks">www.ti.com/clocks</a>
Interface	<a href="http://interface.ti.com">interface.ti.com</a>
Logic	<a href="http://logic.ti.com">logic.ti.com</a>
Power Mgmt	<a href="http://power.ti.com">power.ti.com</a>
Microcontrollers	<a href="http://microcontroller.ti.com">microcontroller.ti.com</a>
RFID	<a href="http://www.ti-rfid.com">www.ti-rfid.com</a>
OMAP Applications Processors	<a href="http://www.ti.com/omap">www.ti.com/omap</a>
Wireless Connectivity	<a href="http://www.ti.com/wirelessconnectivity">www.ti.com/wirelessconnectivity</a>

### Applications

Automotive and Transportation	<a href="http://www.ti.com/automotive">www.ti.com/automotive</a>
Communications and Telecom	<a href="http://www.ti.com/communications">www.ti.com/communications</a>
Computers and Peripherals	<a href="http://www.ti.com/computers">www.ti.com/computers</a>
Consumer Electronics	<a href="http://www.ti.com/consumer-apps">www.ti.com/consumer-apps</a>
Energy and Lighting	<a href="http://www.ti.com/energy">www.ti.com/energy</a>
Industrial	<a href="http://www.ti.com/industrial">www.ti.com/industrial</a>
Medical	<a href="http://www.ti.com/medical">www.ti.com/medical</a>
Security	<a href="http://www.ti.com/security">www.ti.com/security</a>
Space, Avionics and Defense	<a href="http://www.ti.com/space-avionics-defense">www.ti.com/space-avionics-defense</a>
Video and Imaging	<a href="http://www.ti.com/video">www.ti.com/video</a>

### TI E2E Community

[e2e.ti.com](http://e2e.ti.com)