

Application Report

TPS25830-Q1 Functional Safety FIT Rate, FMD and Pin FMA



Table of Contents

1 Overview.....	2
2 Functional Safety Failure In Time (FIT) Rates.....	3
3 Failure Mode Distribution (FMD).....	4

Trademarks

All other trademarks are the property of their respective owners.

1 Overview

This document contains information for TPS25830-Q1 (VQFN package) to aid in a functional safety system design. Information provided are:

- Functional Safety Failure In Time (FIT) rates of the semiconductor component estimated by the application of industry reliability standards
- Component failure modes and their distribution (FMD) based on the primary function of the device

Figure 1-1 shows the device functional block diagram for reference.

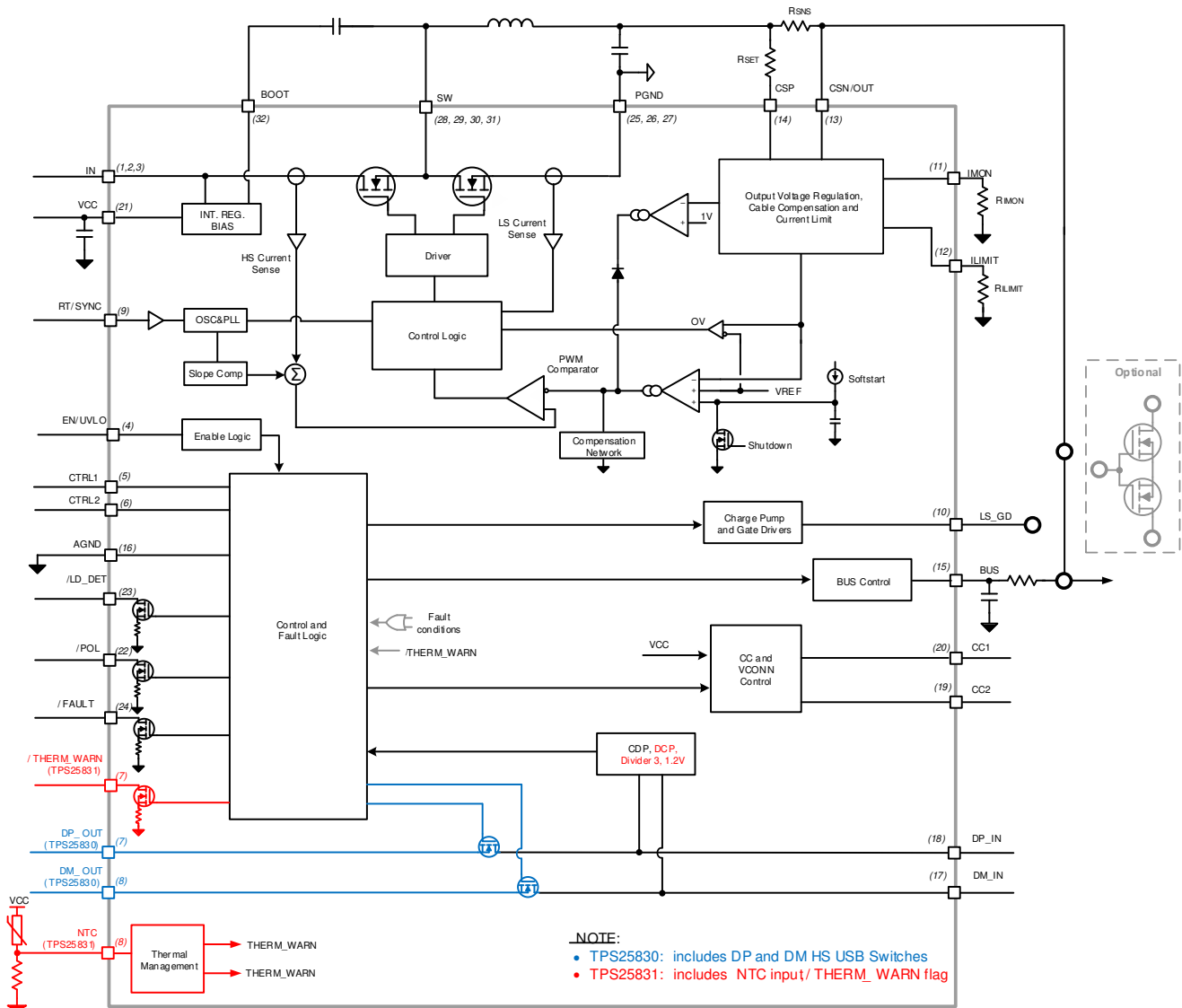

Figure 1-1. Functional Block Diagram

TPS25830-Q1 was developed using a quality-managed development process, but was not developed in accordance with the IEC 61508 or ISO 26262 standards.

2 Functional Safety Failure In Time (FIT) Rates

This section provides Functional Safety Failure In Time (FIT) rates for TPS25830-Q1 based on two different industry-wide used reliability standards:

- [Table 2-1](#) provides FIT rates based on IEC TR 62380 / ISO 26262 part 11
- [Table 2-2](#) provides FIT rates based on the Siemens Norm SN 29500-2

Table 2-1. Component Failure Rates per IEC TR 62380 / ISO 26262 Part 11

FIT IEC TR 62380 / ISO 26262	FIT (Failures Per 10 ⁹ Hours)
Total FIT Rate	27
Die FIT Rate	8
Package FIT Rate	19

The failure rate and mission profile information in [Table 2-1](#) comes from the Reliability data handbook IEC TR 62380 / ISO 26262 part 11:

- Mission Profile: Motor Control from Table 11
- Power dissipation: 1300 mW
- Climate type: World-wide Table 8
- Package factor (λ_3): Table 17b
- Substrate Material: FR4
- EOS FIT rate assumed: 0 FIT

Table 2-2. Component Failure Rates per Siemens Norm SN 29500-2

Table	Category	Reference FIT Rate	Reference Virtual T _J
5	Digital, Analog, Mixed	25 FIT	55°C

The Reference FIT Rate and Reference Virtual T_J (junction temperature) in [Table 2-2](#) come from the Siemens Norm SN 29500-2 tables 1 through 5. Failure rates under operating conditions are calculated from the reference failure rate and virtual junction temperature using conversion information in SN 29500-2 section 4.

3 Failure Mode Distribution (FMD)

The failure mode distribution estimation for TPS25830-Q1 in [Table 3-1](#) comes from the combination of common failure modes listed in standards such as IEC 61508 and ISO 26262, the ratio of sub-circuit function size and complexity and from best engineering judgment.

The failure modes listed in this section reflect random failure events and do not include failures due to misuse or overstress.

Table 3-1. Die Failure Modes and Distribution

Die Failure Modes	Failure Mode Distribution (%)
SW no output	25%
CSP and CSN/OUT not in specification – voltage or timing	20%
LS_GD no output	5%
LS_GD not in specification – voltage or timing	5%
DP_IN, DM_IN, DP_OUT, DM_OUT – no output	10%
DP_IN, DM_IN, DP_OUT, DM_OUT – not in specification – voltage or timing	10%
CC1, CC2 no output	5%
CC1, CC2 not in specification – voltage or timing	10%
FAULT, POL, LD_DET false trip or fails to trip	5%
Short circuit any two pins	5%

The FMD in [Table 3-1](#) excludes short circuit faults across the isolation barrier. Faults for short circuit across the isolation barrier can be excluded according to ISO 61800-5-2:2016 if the following requirements are fulfilled:

1. The signal isolation component is OVC III according to IEC 61800-5-1. If a SELV/PELV power supply is used, pollution degree 2/OVC II applies. All requirements of IEC 61800-5-1:2007, 4.3.6 apply.
2. Measures are taken to ensure that an internal failure of the signal isolation component cannot result in excessive temperature of its insulating material.

Creepage and clearance requirements should be applied according to the specific equipment isolation standards of an application. Care should be taken to maintain the creepage and clearance distance of a board design to ensure that the mounting pads of the isolator on the printed-circuit board do not reduce this distance.

IMPORTANT NOTICE AND DISCLAIMER

TI PROVIDES TECHNICAL AND RELIABILITY DATA (INCLUDING DATA SHEETS), DESIGN RESOURCES (INCLUDING REFERENCE DESIGNS), APPLICATION OR OTHER DESIGN ADVICE, WEB TOOLS, SAFETY INFORMATION, AND OTHER RESOURCES "AS IS" AND WITH ALL FAULTS, AND DISCLAIMS ALL WARRANTIES, EXPRESS AND IMPLIED, INCLUDING WITHOUT LIMITATION ANY IMPLIED WARRANTIES OF MERCHANTABILITY, FITNESS FOR A PARTICULAR PURPOSE OR NON-INFRINGEMENT OF THIRD PARTY INTELLECTUAL PROPERTY RIGHTS.

These resources are intended for skilled developers designing with TI products. You are solely responsible for (1) selecting the appropriate TI products for your application, (2) designing, validating and testing your application, and (3) ensuring your application meets applicable standards, and any other safety, security, regulatory or other requirements.

These resources are subject to change without notice. TI grants you permission to use these resources only for development of an application that uses the TI products described in the resource. Other reproduction and display of these resources is prohibited. No license is granted to any other TI intellectual property right or to any third party intellectual property right. TI disclaims responsibility for, and you will fully indemnify TI and its representatives against, any claims, damages, costs, losses, and liabilities arising out of your use of these resources.

TI's products are provided subject to [TI's Terms of Sale](#) or other applicable terms available either on ti.com or provided in conjunction with such TI products. TI's provision of these resources does not expand or otherwise alter TI's applicable warranties or warranty disclaimers for TI products.

TI objects to and rejects any additional or different terms you may have proposed.

Mailing Address: Texas Instruments, Post Office Box 655303, Dallas, Texas 75265
Copyright © 2022, Texas Instruments Incorporated