

# TPS6282x 5.5-V, 1-A, 2-A, 3-A Step-Down Converter Family with 1% Accuracy

## 1 Features

- DCS-Control™ topology
- 26-mΩ/25-mΩ internal power switches (TPS62823)
- Up to 3-A output current (TPS62823)
- Very low quiescent current of 4 μA
- Switching frequency of typically 2.2 MHz
- 1% feedback voltage accuracy (full temp. range)
- Enable (EN) and power good (PG)
- Adjustable output voltage from 0.6 V to 4 V
- 100% duty-cycle mode
- Internal soft-start circuitry
- Seamless power save mode transition
- Undervoltage lockout
- Active output discharge
- Cycle-by-cycle current limit
- HICCUP short-circuit protection
- Over temperature protection
- CISPR11 class B compliant
- Create a custom design using the TPS62822 with the [WEBENCH® Power Designer](#)

## 2 Applications

- POL supply in portable/battery powered devices
- Factory and building automation
- Mobile computing, networking cards
- Solid state drive
- Data terminal, point of sale
- Servers, projectors, printers

### Typical Application Schematic

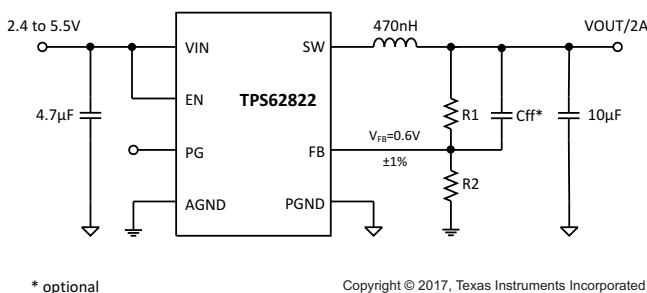

## 3 Description

The TPS6282x is an all-purpose and easy to use synchronous step-down DC-DC converter with a very low quiescent current of only 4 μA. It supplies up to 3A output current (TPS62823) from a 2.4-V to 5.5-V input voltage. Based on the DCS-Control™ topology it provides a fast transient response.

The internal reference allows to regulate the output voltage down to 0.6 V with a high feedback voltage accuracy of 1% over the junction temperature range of -40°C to 125°C. The 1-A, 2-A, 3-A scalable pin-to-pin and BOM-to-BOM compatible device family can be used with small 470-nH inductors.

The TPS6282x include an automatically entered power save mode to maintain high efficiency down to very light loads.

The device features a Power Good signal and an internal soft start circuit. It is able to operate in 100% mode. For fault protection, it incorporates a HICCUP current limit as well as a thermal shutdown.

The TPS6282x are packaged in a 2 mm x 1.5 mm QFN-8 package.

### Device Information<sup>(1)</sup>

| PART NUMBER | PACKAGE | BODY SIZE (NOM) |
|-------------|---------|-----------------|
| TPS62821DLC | QFN (8) | 2.00 x 1.50 mm  |
| TPS62822DLC |         |                 |
| TPS62823DLC |         |                 |

(1) For all available packages, see the orderable addendum at the end of the data sheet.

### Efficiency vs Output Current

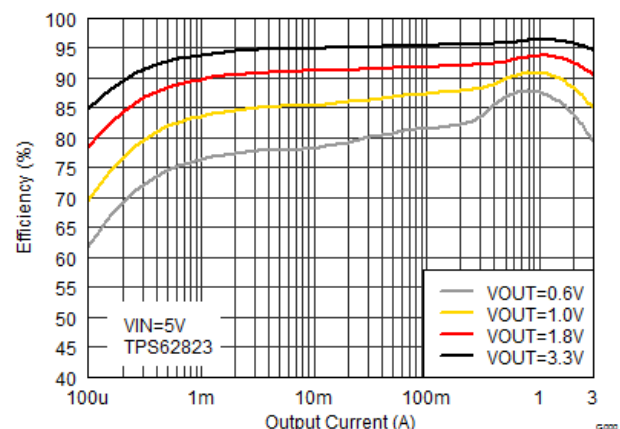

## Table of Contents

|  |          |  |           |
|--|----------|--|-----------|
| <b>1 Features</b> .....                        | <b>1</b> | 8.4 Device Functional Modes.....                                 | <b>8</b>  |
| <b>2 Applications</b> .....                    | <b>1</b> | <b>9 Application and Implementation</b> .....                    | <b>10</b> |
| <b>3 Description</b> .....                     | <b>1</b> | 9.1 Application Information.....                                 | <b>10</b> |
| <b>4 Revision History</b> .....                | <b>2</b> | 9.2 Typical Application .....                                    | <b>10</b> |
| <b>5 Device Comparison Table</b> .....         | <b>3</b> | <b>10 Power Supply Recommendations</b> .....                     | <b>21</b> |
| <b>6 Pin Configuration and Functions</b> ..... | <b>3</b> | <b>11 Layout</b> .....   | <b>21</b> |
| <b>7 Specifications</b> .....                  | <b>4</b> | 11.1 Layout Guidelines .....                                     | <b>21</b> |
| 7.1 Absolute Maximum Ratings .....             | <b>4</b> | 11.2 Layout Example .....  | <b>22</b> |
| 7.2 ESD Ratings .....                          | <b>4</b> | <b>12 Device and Documentation Support</b> .....                 | <b>23</b> |
| 7.3 Recommended Operating Conditions.....      | <b>4</b> | 12.1 Device Support .....  | <b>23</b> |
| 7.4 Thermal Information .....                  | <b>4</b> | 12.2 Related Links .....   | <b>23</b> |
| 7.5 Electrical Characteristics.....            | <b>5</b> | 12.3 Receiving Notification of Documentation Updates             | <b>23</b> |
| 7.6 Typical Characteristics.....               | <b>6</b> | 12.4 Community Resources.....                                    | <b>23</b> |
| <b>8 Detailed Description</b> .....            | <b>7</b> | 12.5 Trademarks .....  | <b>23</b> |
| 8.1 Overview .....                             | <b>7</b> | 12.6 Electrostatic Discharge Caution.....                        | <b>23</b> |
| 8.2 Functional Block Diagram .....             | <b>7</b> | 12.7 Glossary .....  | <b>23</b> |
| 8.3 Feature Description.....                   | <b>8</b> | <b>13 Mechanical, Packaging, and Orderable Information</b> ..... | <b>23</b> |

## 4 Revision History

NOTE: Page numbers for previous revisions may differ from page numbers in the current version.

| <b>Changes from Revision B (May 2018) to Revision C</b> | <b>Page</b> |
|---|-------------|
| • Added EMI Performance Curves .....                    | <b>17</b>   |

| <b>Changes from Revision A (February 2018) to Revision B</b>               | <b>Page</b> |
|--|-------------|
| • Changed status for TPS62822 and TPS62823 to Production Data devices..... | <b>23</b>   |

| <b>Changes from Original (November 2017) to Revision A</b>   | <b>Page</b> |
|--|-------------|
| • Changed status for TPS62821 to Production Data device..... | <b>23</b>   |

## 5 Device Comparison Table

| Part Number | Output Current | Output Voltage <sup>(1)</sup> |
|-------------|----------------|-------------------------------|
| TPS62821DLC | 1 A            | Adjustable                    |
| TPS62822DLC | 2 A            | Adjustable                    |
| TPS62823DLC | 3 A            | Adjustable                    |

(1) For fixed output voltage versions please contact your TI sales representative.

## 6 Pin Configuration and Functions

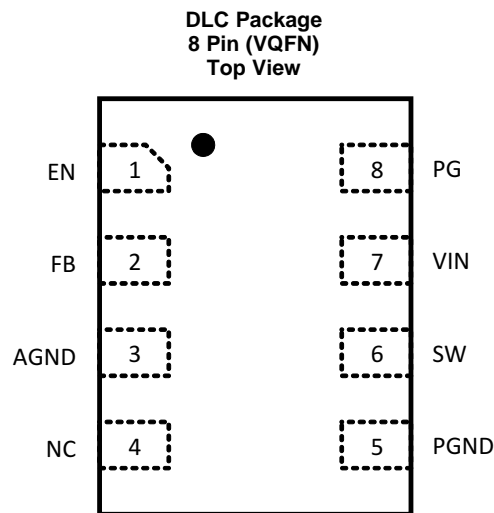

### Pin Functions

| PIN  |     | I/O   | DESCRIPTION  |
|------|-----|-------|--|
| NAME | NO. |       |  |
| EN   | 1   | I     | Enable input (High=Enabled, Low=Disabled). Do not leave floating.          |
| FB   | 2   | I     | Output voltage feedback. Connect resistive voltage divider to this pin.    |
| AGND | 3   |       | Signal ground. Internally connected to the PGND pin. Can be left floating. |
| NC   | 4   |       | Internally not connected. Can be connected to VOUT, GND or left floating.  |
| PGND | 5   | Power | Power ground   |
| SW   | 6   | Power | Switch node, connected to the internal MOSFET switches.                    |
| VIN  | 7   | Power | Supply voltage   |
| PG   | 8   | O     | Power good output. If unused, leave floating or connect to GND.            |

## 7 Specifications

### 7.1 Absolute Maximum Ratings<sup>(1)</sup>

|  |  | MIN  | MAX       | UNIT |
|--|--|------|-----------|------|
| Pin Voltage Range                        | VIN, FB, EN, PG, NC                    | -0.3 | 6         | V    |
|  | SW (DC)                                | -0.3 | VIN + 0.3 |      |
|  | SW (DC, in current limit)              | -1.0 |           |      |
|  | SW (AC), less than 10ns <sup>(2)</sup> | -2.5 | 10        |      |
| Power Good Sink Current                  |  |      | 1         | mA   |
| Operating Junction Temperature Range, TJ |  | -40  | 150       | °C   |
| Storage temperature, Tstg                |  | -65  | 150       | °C   |

- (1) Stresses beyond those listed under *Absolute Maximum Ratings* may cause permanent damage to the device. These are stress ratings only, which do not imply functional operation of the device at these or any other conditions beyond those indicated under *Recommended Operating Conditions*. Exposure to absolute-maximum-rated conditions for extended periods may affect device reliability.
- (2) While switching.

### 7.2 ESD Ratings

|                                |  | VALUE | UNIT |
|--------------------------------|--|-------|------|
| V(ESD) Electrostatic discharge | Human-body model (HBM), per ANSI/ESDA/JEDEC JS-001 <sup>(1)</sup>              | ±2000 | V    |
|                                | Charged-device model (CDM), per JEDEC specification JESD22-C101 <sup>(2)</sup> | ±500  |      |

- (1) JEDEC document JEP155 states that 500-V HBM allows safe manufacturing with a standard ESD control process.
- (2) JEDEC document JEP157 states that 250-V CDM allows safe manufacturing with a standard ESD control process.

### 7.3 Recommended Operating Conditions

|                                    |          | MIN | NOM | MAX | UNIT |
|------------------------------------|----------|-----|-----|-----|------|
| Supply Voltage Range, VIN          |          | 2.4 |     | 5.5 | V    |
| Output Voltage Range, VOUT         |          | 0.6 |     | 4   | V    |
| Maximum Output Current, IOUT       | TPS62821 |     |     | 1   | A    |
|                                    | TPS62822 |     |     | 2   |      |
|                                    | TPS62823 |     |     | 3   |      |
| Operating Junction Temperature, TJ |          | -40 |     | 125 | °C   |

### 7.4 Thermal Information

| THERMAL METRIC <sup>(1)</sup> |  | TPS6282x          |                    | UNIT |
|-------------------------------|--|-------------------|--------------------|------|
|                               |  | DLC (VQFN) 8 PINS |                    |      |
|                               |  | JEDEC PCB         | TPS6282xEVM-005    |      |
| RθJA                          | Junction-to-ambient thermal resistance       | 114.1             | 69.9               | °C/W |
| RθJC(top)                     | Junction-to-case (top) thermal resistance    | 90.2              | n/a <sup>(2)</sup> | °C/W |
| RθJB                          | Junction-to-board thermal resistance         | 43.4              | n/a <sup>(2)</sup> | °C/W |
| ψJT                           | Junction-to-top characterization parameter   | 6.6               | 4.3                | °C/W |
| ψJB                           | Junction-to-board characterization parameter | 43.7              | 44.2               | °C/W |
| RθJC(bot)                     | Junction-to-case (bottom) thermal resistance | n/a               | n/a                | °C/W |

- (1) For more information about traditional and new thermal metrics, see the [Semiconductor and IC Package Thermal Metrics](#) application report.
- (2) Not applicable to an EVM.

## 7.5 Electrical Characteristics

over operating junction temperature range ( $T_J = -40^\circ\text{C}$  to  $125^\circ\text{C}$ ) and  $V_{IN} = 2.4\text{V}$  to  $5.5\text{V}$ . Typical values at  $V_{IN} = 5\text{V}$  and  $T_J = 25^\circ\text{C}$  (unless otherwise noted)

| PARAMETER               |   | TEST CONDITIONS   | MIN  | TYP  | MAX  | UNIT             |
|-------------------------|---|---|------|------|------|------------------|
| <b>SUPPLY</b>           |   |   |      |      |      |                  |
| $V_{IN}$                | Input Voltage range                       |   | 2.4  |      | 5.5  | V                |
| $I_Q$                   | Operating Quiescent Current               | EN=High, $I_{OUT}=0\text{A}$ , device not switching     |      | 4    | 10   | $\mu\text{A}$    |
| $I_{SD}$                | Shutdown Current                          | EN=Low, $T_J = -40^\circ\text{C}$ to $85^\circ\text{C}$ |      | 0.05 | 0.5  | $\mu\text{A}$    |
| $V_{UVLO}$              | Undervoltage Threshold                    | Falling Input Voltage                                   | 2.1  | 2.2  | 2.3  | V                |
|                         | Undervoltage Hysteresis                   |   |      | 160  |      | mV               |
| $T_{SD}$                | Thermal Shutdown Threshold                | Rising Junction Temperature                             |      | 150  |      | $^\circ\text{C}$ |
|                         | Thermal Shutdown Hysteresis               |   |      | 20   |      |                  |
| <b>CONTROL (EN, PG)</b> |   |   |      |      |      |                  |
| $V_H$                   | High-Level Threshold Voltage (EN)         |   | 1.0  |      |      | V                |
| $V_L$                   | Low-Level Threshold Voltage (EN)          |   |      |      | 0.4  | V                |
| $I_{LKG}$               | Input Leakage Current (EN, PG)            | EN = High, $V_{PG} = 5\text{V}$                         |      | 10   | 100  | nA               |
| $t_{SS}$                | Soft-Start Time                           | Time from EN=High to 95% of $V_{OUT}$ nominal           |      | 1.25 |      | ms               |
| $V_{PGTL}$              | Power Good Lower Threshold Voltage        | Rising ( $V_{FB}$ vs regulation target)                 | 94%  | 96%  | 98%  |                  |
|                         |   | Falling ( $V_{FB}$ vs regulation target)                | 90%  | 92%  | 94%  |                  |
| $V_{PGTH}$              | Power Good Upper Threshold Voltage        | Rising ( $V_{FB}$ vs regulation target)                 | 108% | 110% | 112% |                  |
|                         |   | Falling ( $V_{FB}$ vs regulation target)                | 103% | 105% | 107% |                  |
| $V_{PGL}$               | Power Good Logic Low Level Output Voltage | $I_{PG} = -1\text{mA}$                                  |      |      | 0.4  | V                |
| $t_{PGD}$               | Power Good delay                          | rising  |      | 100  |      | $\mu\text{s}$    |
|                         |   | falling   |      | 20   |      |                  |
| <b>POWER SWITCH</b>     |   |   |      |      |      |                  |
| $F_{SW}$                | Switching Frequency                       | PWM Mode Operation                                      |      | 2.2  |      | MHz              |
| $R_{DS(on)}$            | High-Side FET ON-Resistance               | TPS62821  |      | 35   |      | m $\Omega$       |
|                         |   | TPS62822  |      | 35   |      |                  |
|                         |   | TPS62823  |      | 26   |      |                  |
|                         | Low-Side FET ON-Resistance                | TPS62821,2,3  |      | 25   |      |                  |
| $I_{LIM}$               | High-Side FET Current Limit               | TPS62821  | 1.7  | 2.1  | 2.4  | A                |
|                         |   | TPS62822  | 2.7  | 3.3  | 3.7  |                  |
|                         |   | TPS62823  | 3.7  | 4.3  | 5.0  |                  |
| <b>OUTPUT</b>           |   |   |      |      |      |                  |
| $I_{LKG\_FB}$           | Input Leakage Current (FB)                | EN=High, $V_{FB}=0.6\text{V}$                           |      | 10   | 50   | nA               |
| $V_{FB}$                | Feedback Voltage Accuracy                 | PWM Mode  | 594  | 600  | 606  | mV               |
| $I_{DIS}$               | Output Discharge Current                  | EN=Low, $V_{SW} = 0.4\text{V}$                          | 75   | 400  |      | mA               |
|                         | DC Load Regulation                        | PWM Mode Operation                                      |      | 0.2  |      | %/A              |
|                         | DC Line Regulation                        | PWM Mode Operation                                      |      | 0.05 |      | %/V              |

.0

## 7.6 Typical Characteristics

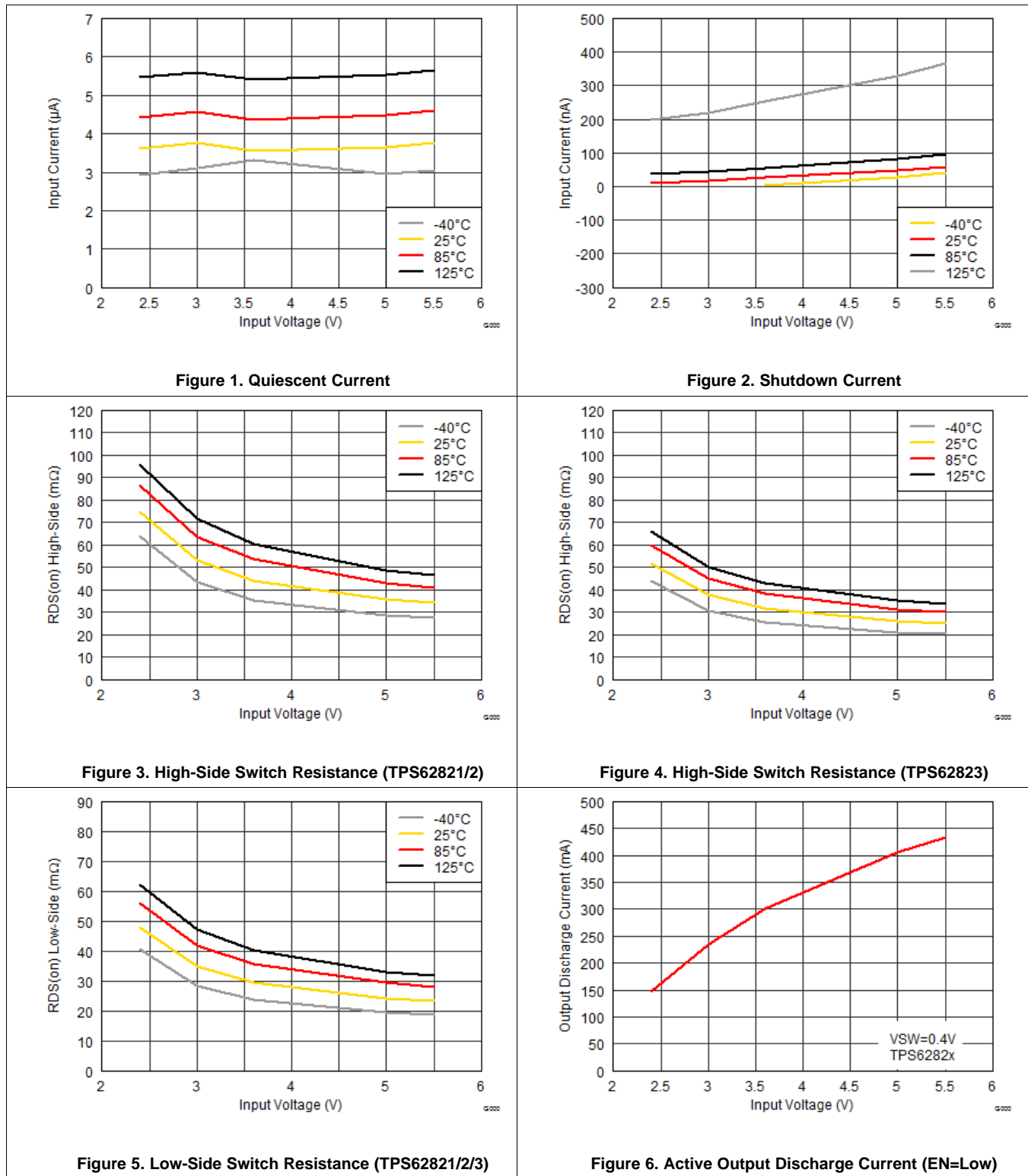

## 8 Detailed Description

### 8.1 Overview

The TPS6282x are synchronous step-down converters based on the DCS-Control™ topology with an adaptive constant on-time control and a stabilized switching frequency. It operates in PWM (pulse width modulation) mode for medium to heavy loads and in PSM (power save mode) at light load conditions, keeping the output voltage ripple small. The nominal switching frequency is about 2.2MHz with a small and controlled variation over the input voltage range. As the load current decreases, the converter enters PSM, reducing the switching frequency to keep efficiency high over the entire load current range. Since combining both PWM and PSM within a single building block, the transition between modes is seamless and without effect on the output voltage. The devices offer both excellent dc voltage and fast load transient regulation, combined with a very low output voltage ripple.

### 8.2 Functional Block Diagram

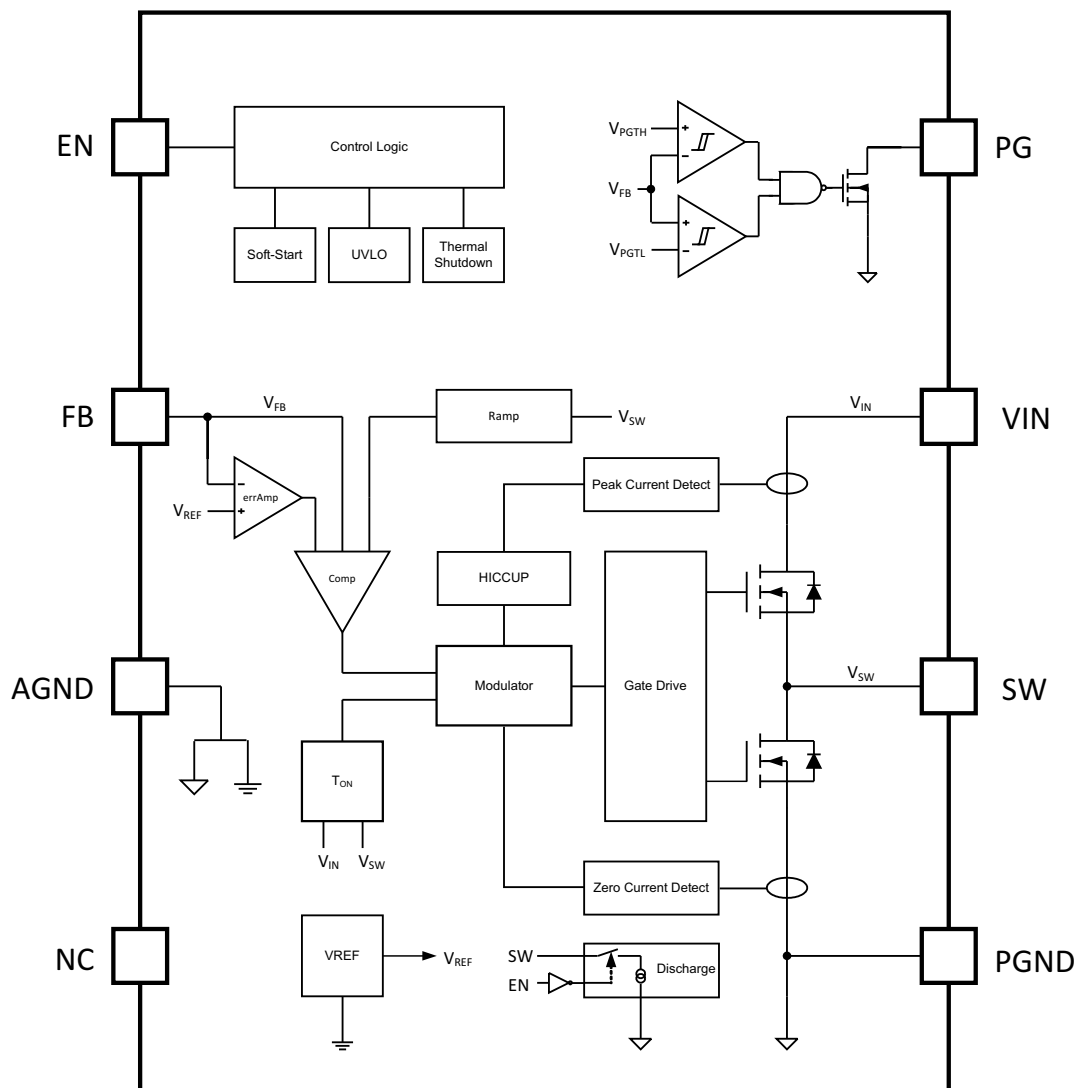

## 8.3 Feature Description

### 8.3.1 Enable / Shutdown and Output Discharge

The device starts operation, when Enable (EN) is set High. The input threshold levels are typically 0.9V for rising and 0.7V for falling signals. Do not leave EN floating. Shutdown is forced if EN is pulled Low with a shutdown current of typically 50nA. During shutdown, the internal power MOSFETs as well as the entire control circuitry are turned off and the output voltage is actively discharged through the SW pin by a current sink. Therefore,  $V_{IN}$  must remain present for the discharge to function.

### 8.3.2 Soft-Start

About 250 $\mu$ s after EN goes High, the internal soft-start circuitry controls the output voltage during startup. This avoids excessive inrush current and ensures a controlled output voltage rise time of about 1ms. It also prevents unwanted voltage drops from high-impedance power sources or batteries. TPS6282x can start into a pre-biased output.

### 8.3.3 Power Good (PG)

The TPS6282x has a built in power good (PG) function. The PG pin goes high impedance, when the output voltage has reached its nominal value. Otherwise, including when disabled, in UVLO or in thermal shutdown, PG is Low (see [Table 1](#)). The PG function is formed with a window comparator, which has an upper and lower voltage threshold (see [Electrical Characteristics](#)). The PG pin is an open drain output that requires a pull-up resistor and can sink up to 1mA. If not used, the PG pin can be left floating or connected to GND.

**Table 1. Power Good Pin Logic**

| Device State         |   | PG Logic Status |     |
|----------------------|---|-----------------|-----|
|                      |   | High Impedance  | Low |
| Enable (EN=High)     | $V_{FB} \geq V_{PGTL}$ and $V_{FB} \leq V_{PGTH}$ | √               |     |
|                      | $V_{FB} \leq V_{PGTL}$ or $V_{FB} \geq V_{PGTH}$  |                 | √   |
| Shutdown (EN=Low)    |   |                 | √   |
| UVLO                 | $0.7\text{ V} < V_{IN} < V_{UVLO}$                |                 | √   |
| Thermal Shutdown     | $T_J > T_{SD}$                                    |                 | √   |
| Power Supply Removal | $V_{IN} < 0.7\text{ V}$                           | √               |     |

At startup, PG transitions from low to floating about 100 $\mu$ s after the output voltage has reached regulation. Once in operation, PG has a deglitch delay of about 20 $\mu$ s before going low. When the output voltage returns to regulation, the same 100 $\mu$ s delay occurs.

### 8.3.4 Undervoltage Lockout (UVLO)

The undervoltage lockout (UVLO) function prevents misoperation of the device, if the input voltage drops below the UVLO threshold. It is set to about 2.2V with a hysteresis of typically 160mV.

### 8.3.5 Thermal Shutdown

The junction temperature ( $T_J$ ) of the device is monitored by an internal temperature sensor. If  $T_J$  exceeds 150°C (typ.), the device goes in thermal shutdown with a hysteresis of typically 20°C. Once the  $T_J$  has decreased enough, the device resumes normal operation.

## 8.4 Device Functional Modes

### 8.4.1 Pulse Width Modulation (PWM) Operation

At load currents larger than half the inductor ripple current, the device operates in pulse width modulation in continuous conduction mode (CCM).

The PWM operation is based on an adaptive constant on-time control with stabilized switching frequency. To achieve a stable switching frequency in a steady state condition, the on-time is calculated as:



## Device Functional Modes (continued)

$$T_{ON} = \frac{V_{OUT}}{V_{IN}} \cdot 450ns \quad (1)$$

With that, the typical switching frequency is about 2.2MHz.

### 8.4.2 Power Save Mode (PSM) Operation

To maintain high efficiency at light loads, the device enters power save mode (PSM) at the boundary to discontinuous conduction mode (DCM). This happens when the output current becomes smaller than half of the inductor's ripple current. The device operates now with a fixed on-time and the switching frequency further decreases proportional to the load current. It can be calculated as:

$$f_{PSM} = \frac{2 \cdot I_{OUT}}{T_{ON}^2 \cdot \frac{V_{IN}}{V_{OUT}} \left[ \frac{V_{IN} - V_{OUT}}{L} \right]} \quad (2)$$

In PSM, the output voltage rises slightly above the nominal target, which can be minimized using larger output capacitance. At duty cycles larger than 90%, the device may not enter PSM. The device maintains output regulation in PWM mode.

### 8.4.3 Minimum Duty Cycle and 100% Mode Operation

There is no limitation for small duty cycles, since even at very low duty cycles the switching frequency is reduced as needed to always ensure a proper regulation.

If the output voltage level comes close to the input voltage, the device enters 100% mode. While the high-side switch is constantly turned on, the low-side switch is switched off. The difference between  $V_{IN}$  and  $V_{OUT}$  is determined by the voltage drop across the high-side FET and the dc resistance of the inductor. The minimum  $V_{IN}$  that is needed to maintain a specific  $V_{OUT}$  value is estimated as:

$$V_{IN(min)} = V_{OUT} + I_{OUT} (R_{DS(on)} + R_{DC(L)}) \quad (3)$$

### 8.4.4 Current Limit and Short Circuit Protection

The peak switch current of TPS6282x is internally limited, cycle by cycle, to a maximum dc value as specified in [Electrical Characteristics](#). This prevents the device from drawing excessive current in case of externally caused over current or short circuit condition. Due to an internal propagation delay of about 60ns, the actual ac peak current can exceed the static current limit during that time.

If the current limit threshold is reached, the device delivers its maximum output current. Detecting this condition for 32 switching cycles (about 13µs), the device turns off the high-side MOSFET for about 100µs which allows the inductor current to decrease through the low-side MOSFET's body diode and then restarts again with a soft start cycle. As long as the overload condition is present, the device hiccups that way, limiting the output power.

## 9 Application and Implementation

### NOTE

Information in the following applications sections is not part of the TI component specification, and TI does not warrant its accuracy or completeness. TI's customers are responsible for determining suitability of components for their purposes. Customers should validate and test their design implementation to confirm system functionality.

### 9.1 Application Information

The TPS6282x is a switched mode step-down converter, able to convert a 2.4-V to 5.5-V input voltage into a lower 0.6-V to 4-V output voltage, providing up to 3A continuous output current (TPS62823). It needs a very low amount of external components. Apart from the inductor and the output and input capacitors, additional parts are only needed to set the output voltage and to enable the Power Good (PG) feature.

### 9.2 Typical Application

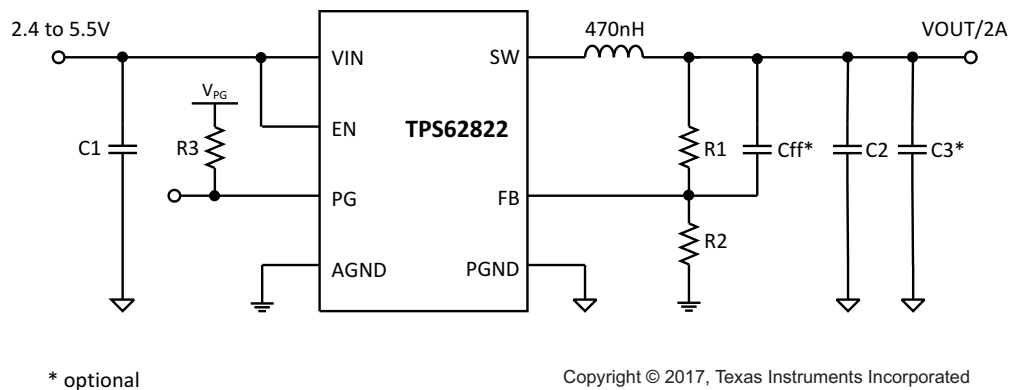

Figure 7. A typical 2.4 to 5.5-V, 2-A Power Supply

#### 9.2.1 Design Requirements

The following design guideline provides a range for the component selection to operate within the recommended operating conditions. Table 2 shows the components selection that was used for the measurements shown in the [Application Curves](#).

Table 2. List of Components

| REFERENCE | DESCRIPTION   | MANUFACTURER                   |
|-----------|---|--------------------------------|
| IC        | 5.5-V, step-down converter                            | TPS6282xDLC, Texas Instruments |
| L1        | 470 nH $\pm 20\%$ , 7.6m $\Omega$ DCR, 6.6A $I_{SAT}$ | XFL4015-471MEB, Coilcraft      |
| C1        | 4.7 $\mu$ F $\pm 20\%$ , 6.3V, ceramic, 0603, X7R     | JMK107BB7475MA-T, Taiyo Yuden  |
| C2, C3    | 10 $\mu$ F $\pm 20\%$ , 10V, ceramic, 0603, X7R       | GRM188Z71A106MA73D, MuRata     |
| Cff       | 120pF $\pm 5\%$ , 50V, 0603                           | GRM1885C1H121JA01D, MuRata     |
| R1, R2    | Depending on VOUT, chip, 0603                         | Standard                       |
| R3        | 100-k $\Omega$ , chip, 0603, 0.1W, 1%                 | Standard                       |

## 9.2.2 Detailed Design Procedure

### 9.2.2.1 Custom Design With WEBENCH® Tools

[Click here](#) to create a custom design using the TPS62822 device with the WEBENCH® Power Designer.

1. Start by entering the input voltage ( $V_{IN}$ ), output voltage ( $V_{OUT}$ ), and output current ( $I_{OUT}$ ) requirements.
2. Optimize the design for key parameters such as efficiency, footprint, and cost using the optimizer dial.
3. Compare the generated design with other possible solutions from Texas Instruments.

The WEBENCH Power Designer provides a customized schematic along with a list of materials with real-time pricing and component availability.

In most cases, these actions are available:

- Run electrical simulations to see important waveforms and circuit performance
- Run thermal simulations to understand board thermal performance
- Export customized schematic and layout into popular CAD formats
- Print PDF reports for the design, and share the design with colleagues

Get more information about WEBENCH tools at [www.ti.com/WEBENCH](http://www.ti.com/WEBENCH).

### 9.2.2.2 Setting the Adjustable Output Voltage

Choose resistors  $R_1$  and  $R_2$  to set the output voltage within a range of 0.6V to 4V, according to [Equation 4](#). To keep the feedback (FB) net robust from noise, set  $R_2$  equal to or lower than 120k $\Omega$  to have at least 5 $\mu$ A of current in the voltage divider. Lower values of FB resistors achieve better noise immunity, and lower light load efficiency, as explained in [SLYT469](#).

$$R1 = R2 \times \left( \frac{V_{OUT}}{V_{FB}} - 1 \right) = R2 \times \left( \frac{V_{OUT}}{0.6V} - 1 \right) \quad (4)$$

### 9.2.2.3 Feed-forward Capacitor Selection

A feedforward capacitor ( $C_{FF}$ ) is recommended in parallel with  $R_1$ . [Equation 5](#) calculates the  $C_{FF}$  value. For the recommended 100k value for  $R_2$ , a 120 pF feed forward capacitor is used.

$$C_{ff} = \frac{12\mu s}{R_2} \quad (5)$$

[Figure 47](#) and [Figure 48](#) show the results of a frequency domain analysis for both use cases, with and without a feed-forward capacitor. The larger unity gain frequency, caused by the feed forward capacitor, results in a significant improvement of the transient response.

### 9.2.2.4 Output Filter Selection

The TPS6282x is internally compensated and optimized for a range of output filter component values, which is specified in [Table 3](#). Using these values simplifies the output filter component selection. Checked cells represent combinations that are proven for stability by simulation and lab test. Further combinations are possible, but should be checked for each individual application.

**Table 3. Recommended LC Output Filter Combinations<sup>(1)</sup>**

|              | 4.7 $\mu$ F | 10 $\mu$ F | 2 x 10 $\mu$ F or 22 $\mu$ F | 47 $\mu$ F       | 100 $\mu$ F      | 150 $\mu$ F |
|--------------|-------------|------------|------------------------------|------------------|------------------|-------------|
| 0.33 $\mu$ H |             |            |                              |                  |                  |             |
| 0.47 $\mu$ H |             | √          | √ <sup>(2)</sup>             | √                | √ <sup>(3)</sup> |             |
| 1.0 $\mu$ H  |             | √          | √                            | √ <sup>(3)</sup> | √ <sup>(3)</sup> |             |
| 1.5 $\mu$ H  |             |            |                              |                  |                  |             |

- (1) The values in the table are the nominal values of inductors and ceramic capacitors. The effective capacitance can vary depending on package size, voltage rating and dielectric material (typical variations are from +20% to -50%).
- (2) This combination is recommended as the standard value for most of all applications.
- (3)  $C_{ff}$  is recommended for large  $C_{OUT}$  values.

### 9.2.2.5 Inductor Selection

The TPS6282x is designed to work with inductors of 470nH nominal and can be used with 1 $\mu$ H inductors as well. The inductor has to be selected for adequate saturation current and a low dc resistance (DCR). The minimum inductor current rating, that is needed under static load conditions is calculated using [Equation 6](#) and [Equation 7](#).

$$I_{peak(max)} = I_{L(min)} = I_{OUT(max)} + \frac{\Delta I_{L(max)}}{2} \quad (6)$$

$$\Delta I_{L(max)} = V_{OUT} \left( \frac{1 - \frac{V_{OUT}}{V_{IN}}}{L_{(min)} \cdot f_{SW}} \right) \quad (7)$$

This calculation gives the minimum saturation current of the inductor needed and an additional margin is recommended to cover dynamic overshoot due to startup or load transients. Inductors are available in different dimensions. Choosing the smallest size might result in less efficiency due to larger DCR and ac losses. The following inductors have been tested with the TPS6282x:

**Table 4. List of Recommended Inductors**

| TYPE                 | Nominal<br>INDUCTANCE <sup>(1)</sup> | Saturation Current and DC<br>Resistance |                             | Dimensions [mm] | Manufacturer <sup>(2)</sup> |
|----------------------|--------------------------------------|---|-----------------------------|-----------------|-----------------------------|
|                      |                                      | max. $I_{SAT}$ [A] <sup>(3)</sup>       | max. $R_{DC}$ [m $\Omega$ ] |                 |                             |
| HTEN20161T-R47MDR    | 0.47                                 | 4.8                                     | 32                          | 2.0 x 1.6 x 1.0 | Cyntec                      |
| HTEH20121T-R47MSR    | 0.47                                 | 4.6                                     | 25                          | 2.0 x 1.2 x 1.0 | Cyntec                      |
| DFE201610E - R47M    | 0.47                                 | 4.8                                     | 32                          | 2.0 x 1.6 x 1.0 | muRata                      |
| DFE201210S - R47M    | 0.47                                 | 4.8                                     | 32                          | 2.0 x 1.2 x 1.0 | muRata                      |
| TFM201610ALM-R47MTAA | 0.47                                 | 5.1                                     | 34                          | 2.0 x 1.6 x 1.0 | TDK                         |
| TFM201610ALC-R47MTAA | 0.47                                 | 5.2                                     | 25                          | 2.0 x 1.6 x 1.0 | TDK                         |
| XFL4015-471ME        | 0.47                                 | 6.6                                     | 8.36                        | 4.0 x 4.0 x 1.6 | Coilcraft                   |

- (1) Inductance Tolerance  $\pm$ 20%
- (2) See [Third-party Products](#) disclaimer.
- (3)  $\Delta L/L \approx$ 30%

### 9.2.2.6 Output Capacitor Selection

The output voltage range of TPS6282x is 0.6V to 4V. While stability is a first criteria for the output filter selection (L and  $C_{OUT}$ ), the output capacitor value also determines transient response behavior and ripple of  $V_{OUT}$ . The recommended typical value for the output capacitor is 2x10 $\mu$ F (or 1x 22 $\mu$ F) and can be small ceramic capacitors with low equivalent series resistance (ESR). For lower  $V_{OUT}$  ( $V_{OUT} \leq 2V$ ) and where only moderate load transients are present, 10 $\mu$ F can be sufficient. In either case a minimum effective output capacitance of 5 $\mu$ F should be present.

To keep low resistance and to get a narrow capacitance variation with temperature, it is recommended to use X7R or X5R dielectric. Using an even higher value has advantages like smaller voltage ripple and tighter output voltage accuracy in PSM.

### 9.2.2.7 Input Capacitor Selection

For typical application, an input capacitor of 4.7 $\mu$ F is sufficient and recommended. A larger value reduces input current ripple further. The input capacitor buffers the input voltage for transient events and also decouples the converter from the supply. A low ESR ceramic capacitor is recommended for best filtering and should be placed between VIN and PGND as close as possible to those pins. In either case a minimum effective input capacitance of 3 $\mu$ F should be present.

### 9.2.3 Application Curves

$V_{IN}=5V$ ,  $V_{OUT}=1.8V$ ,  $T_A=25^{\circ}C$ , BOM = [Table 2](#), (unless otherwise noted)

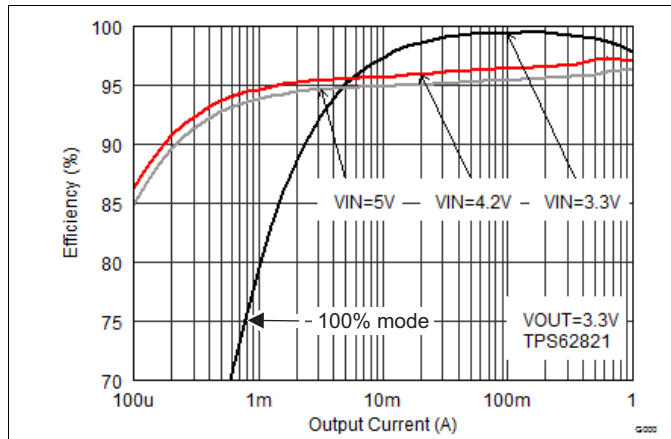

**Figure 8. Efficiency TPS62821 at VOUT=3.3V**

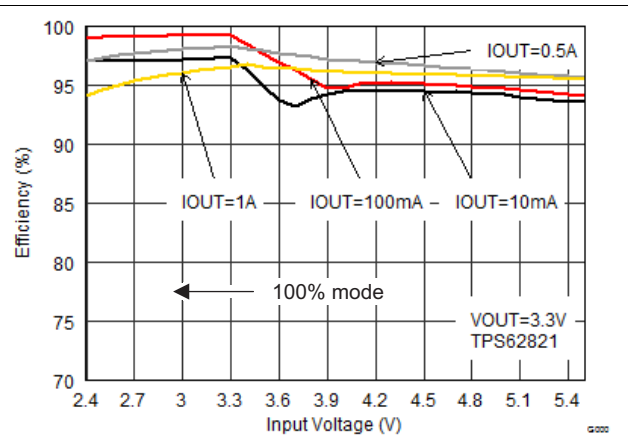

**Figure 9. Efficiency TPS62821 at VOUT=3.3V**

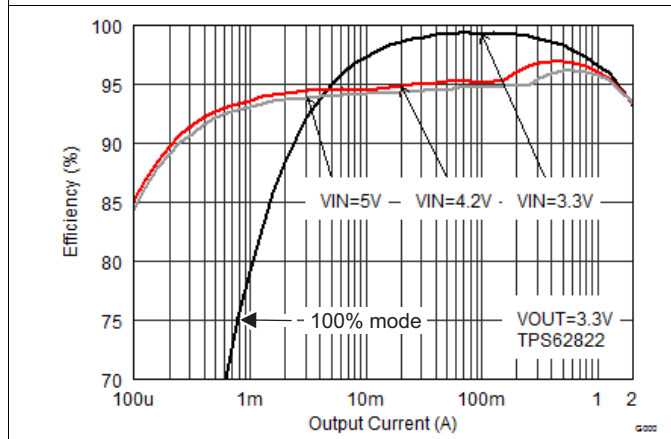

**Figure 10. Efficiency TPS62822 at VOUT=3.3V**

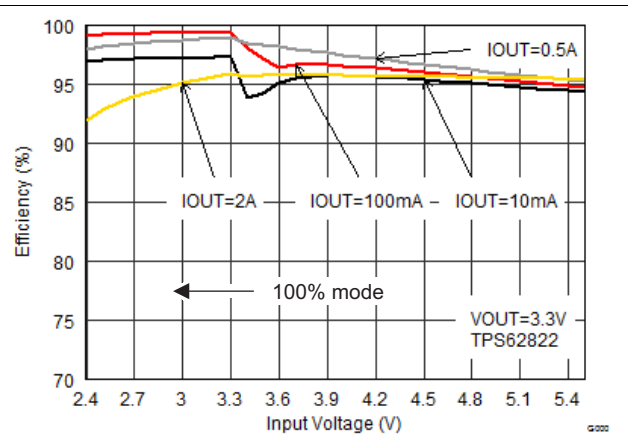

**Figure 11. Efficiency TPS62822 at VOUT=3.3V**

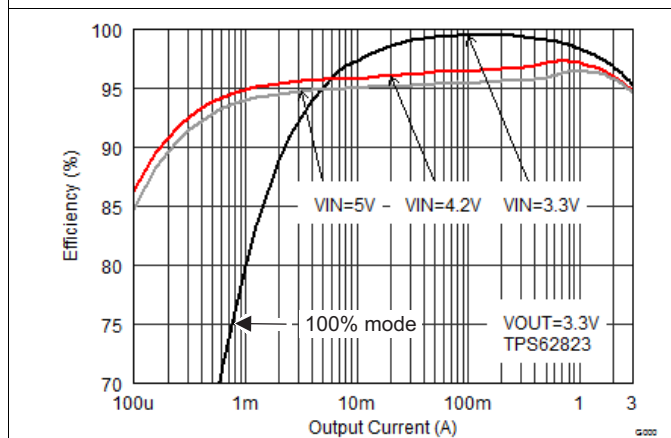

**Figure 12. Efficiency TPS62823 at VOUT=3.3V**

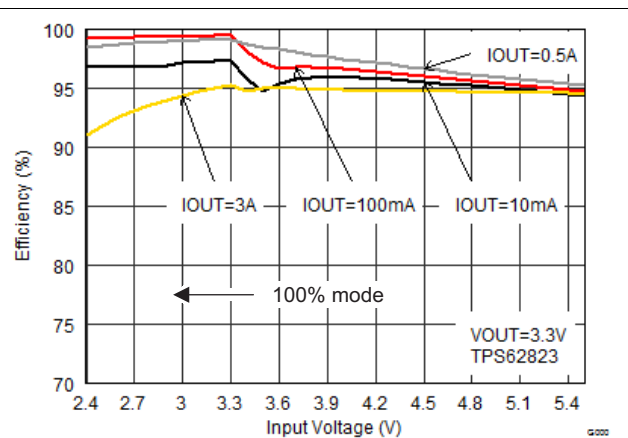

**Figure 13. Efficiency TPS62823 at VOUT=3.3V**

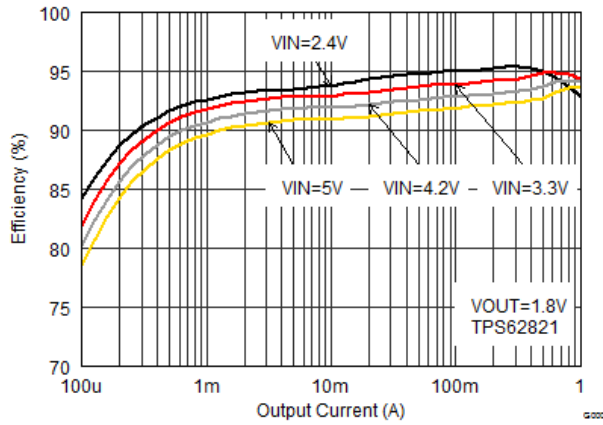

Figure 14. Efficiency TPS62821 at VOUT=1.8V

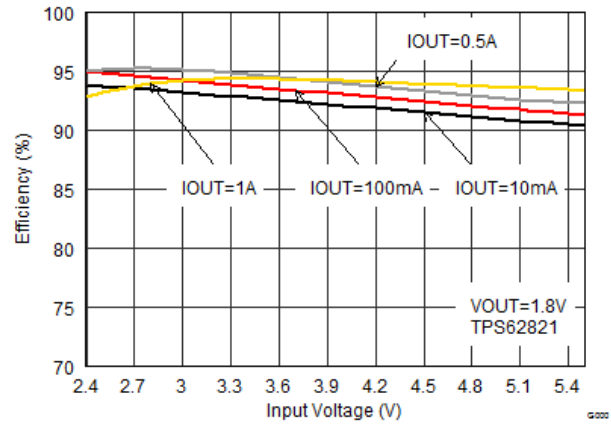

Figure 15. Efficiency TPS62821 at VOUT=1.8V

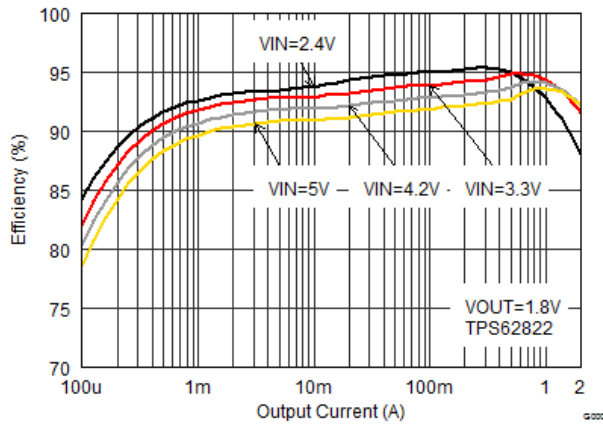

Figure 16. Efficiency TPS62822 at VOUT=1.8V

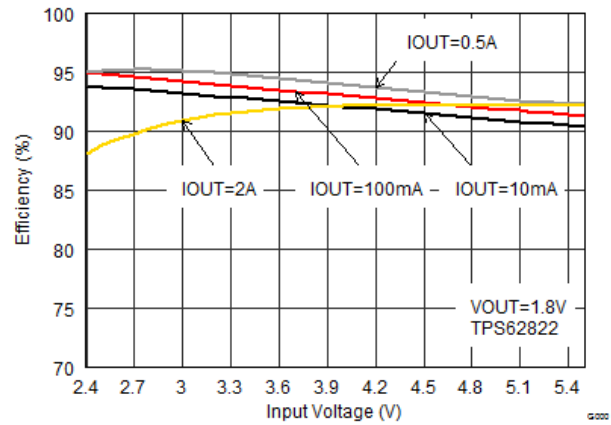

Figure 17. Efficiency TPS62822 at VOUT=1.8V

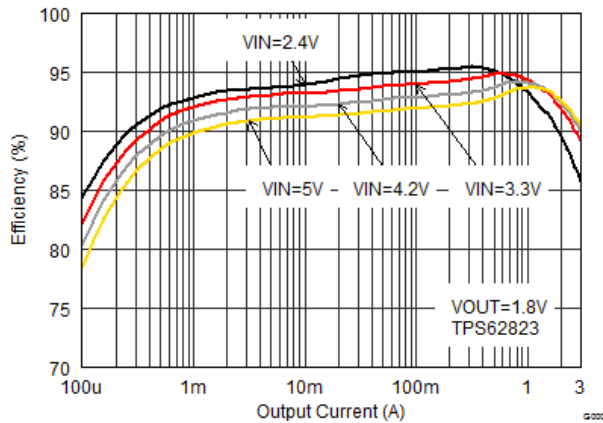

Figure 18. Efficiency TPS62823 at VOUT=1.8V

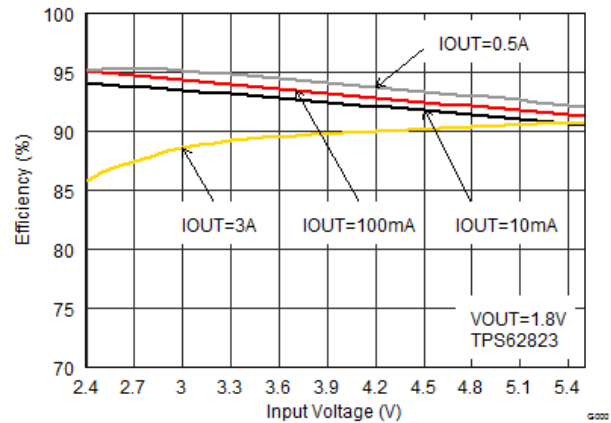

Figure 19. Efficiency TPS62823 at VOUT=1.8V

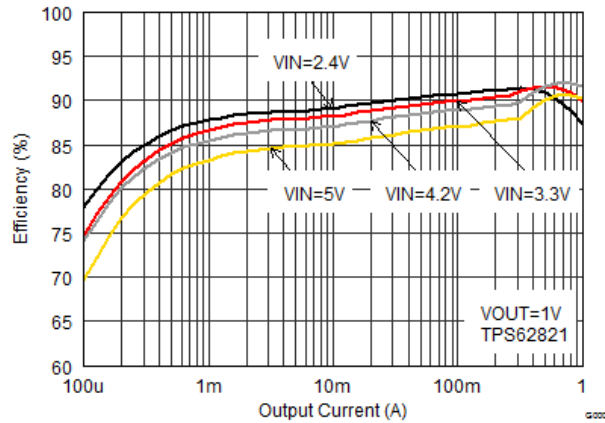

Figure 20. Efficiency TPS62821 at VOUT=1V

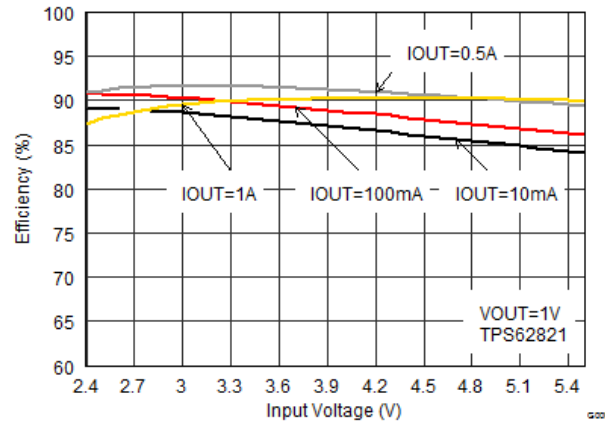

Figure 21. Efficiency TPS62821 at VOUT=1V

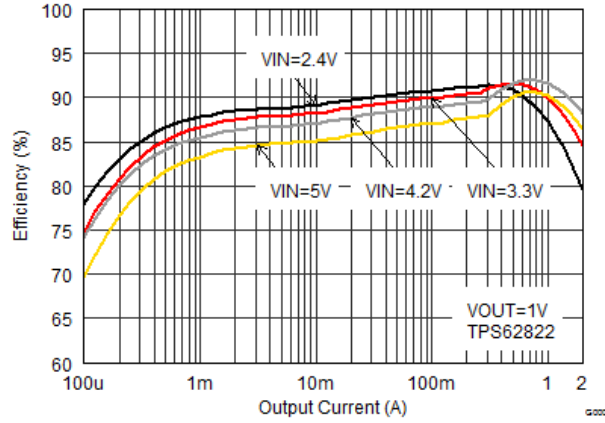

Figure 22. Efficiency TPS62822 at VOUT=1V

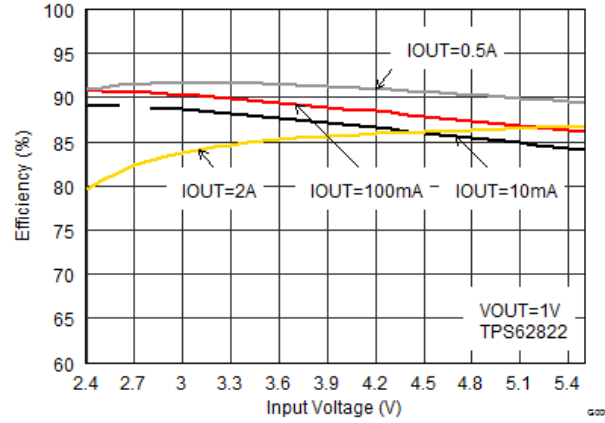

Figure 23. Efficiency TPS62822 at VOUT=1V

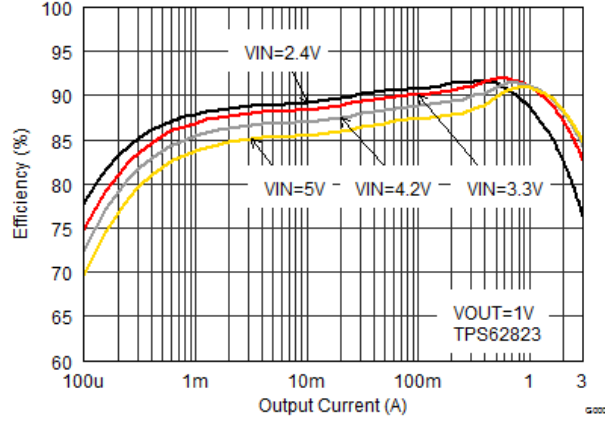

Figure 24. Efficiency TPS62823 at VOUT=1V

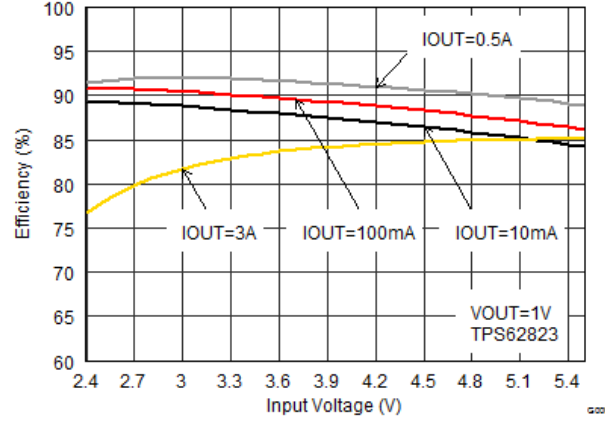

Figure 25. Efficiency TPS62823 at VOUT=1V



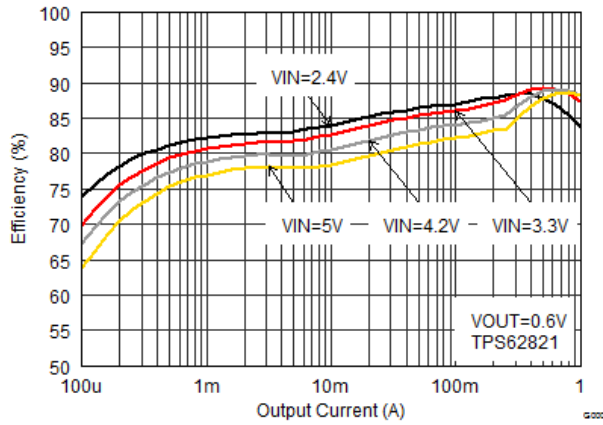

Figure 26. Efficiency TPS62821 at VOUT=0.6V

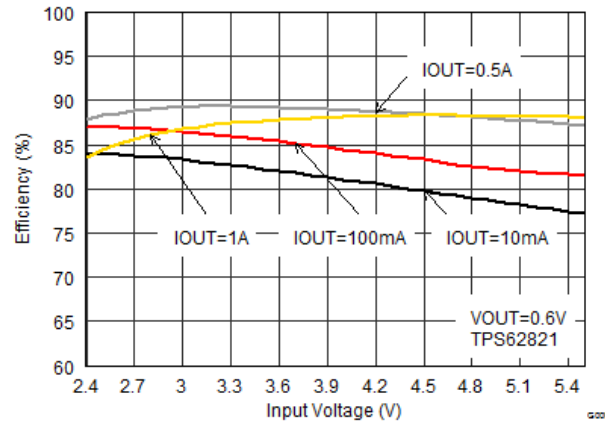

Figure 27. Efficiency TPS62821 at VOUT=0.6V

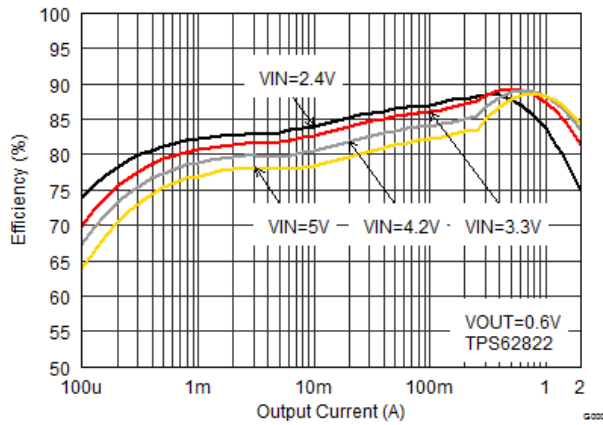

Figure 28. Efficiency TPS62822 at VOUT=0.6V

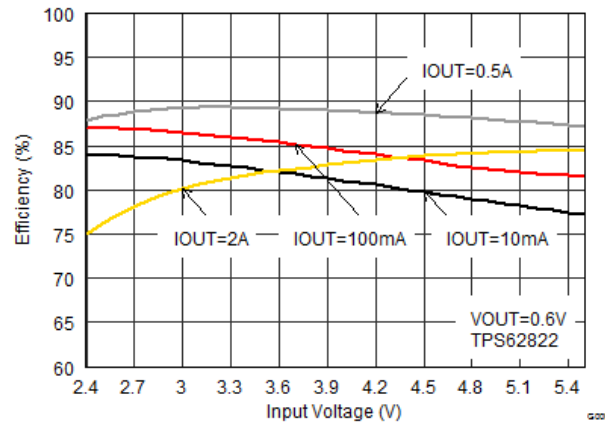

Figure 29. Efficiency TPS62822 at VOUT=0.6V

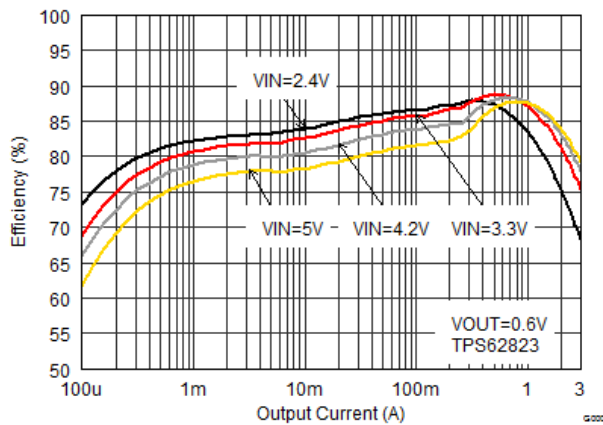

Figure 30. Efficiency TPS62823 at VOUT=0.6V

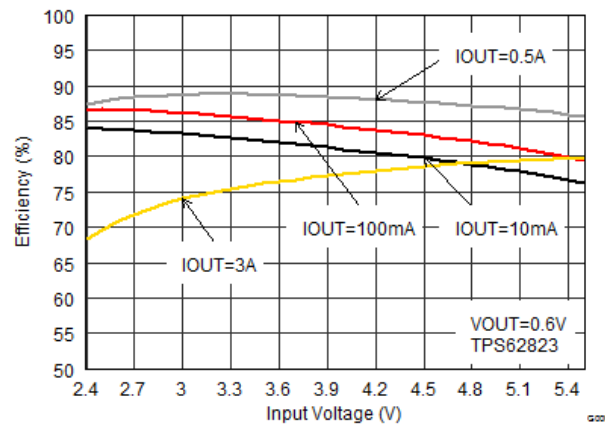

Figure 31. Efficiency TPS62823 at VOUT=0.6V

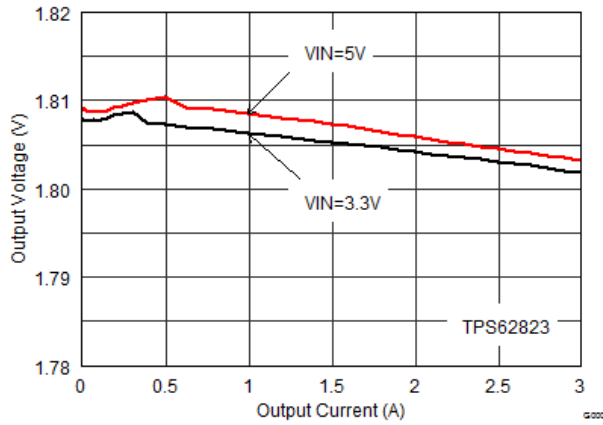

Figure 32. Output Voltage Accuracy (Load Regulation)

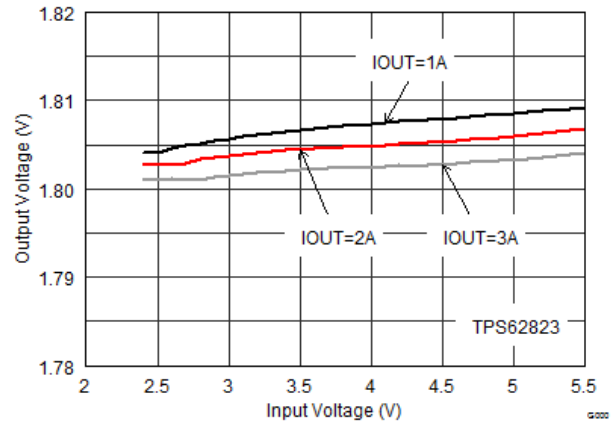

Figure 33. Output Voltage Accuracy (Line Regulation)

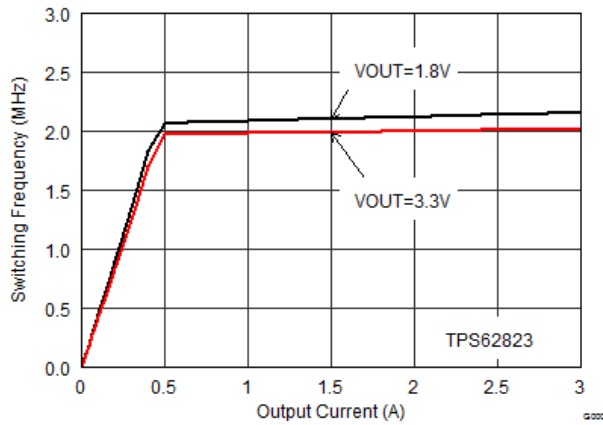

Figure 34. Switching Frequency vs Output Current

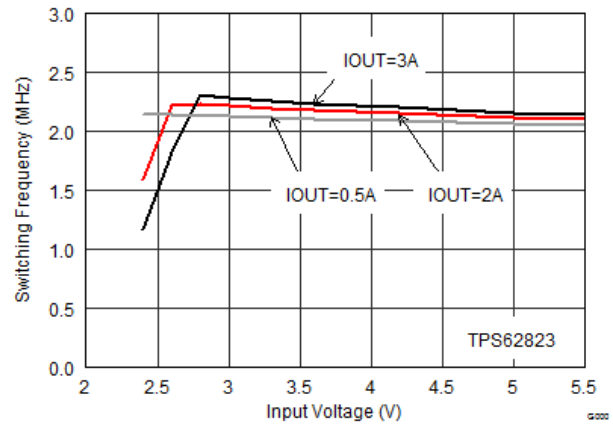

Figure 35. Switching Frequency vs Input Voltage

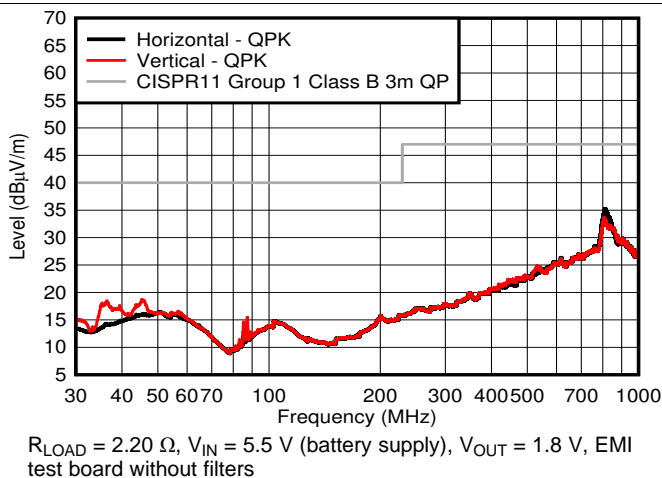

Figure 36. TPS62821 Radiated Emission

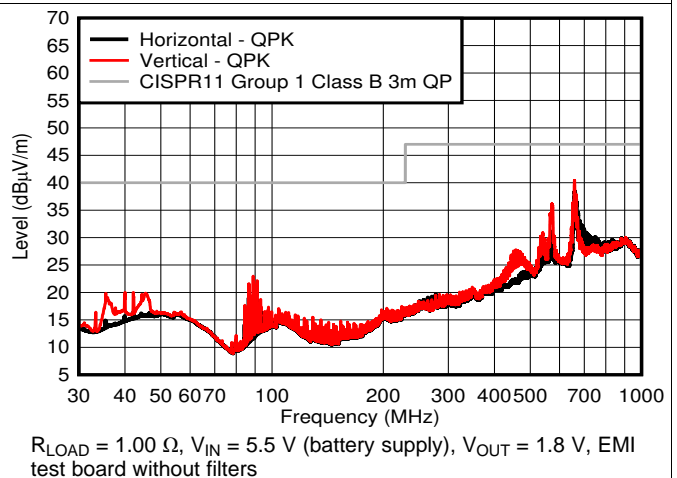

Figure 37. TPS62822 Radiated Emission

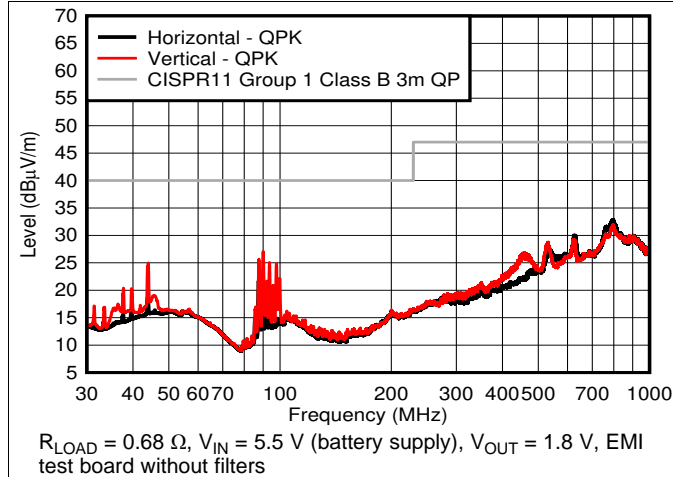

Figure 38. TPS62823 Radiated Emission

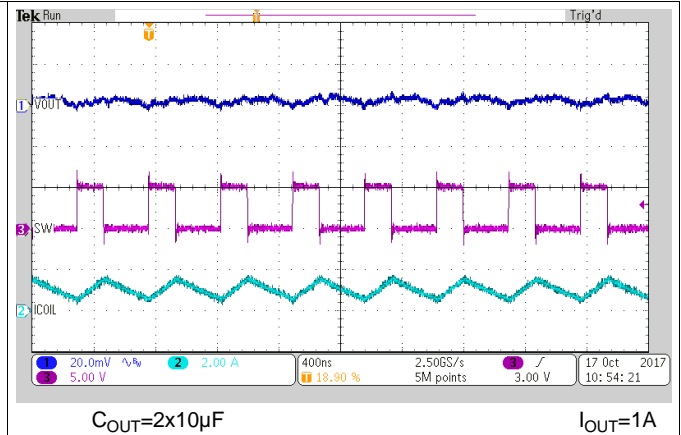

Figure 39. Typical Operation PWM

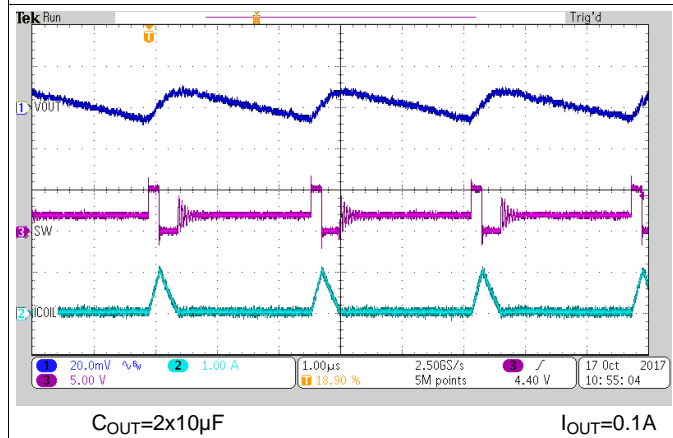

Figure 40. Typical Operation PSM

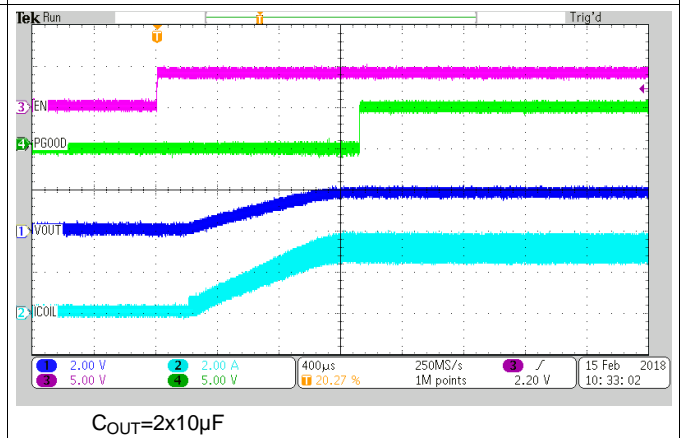

Figure 41. Startup into 0.6-Ohm (TPS62823)

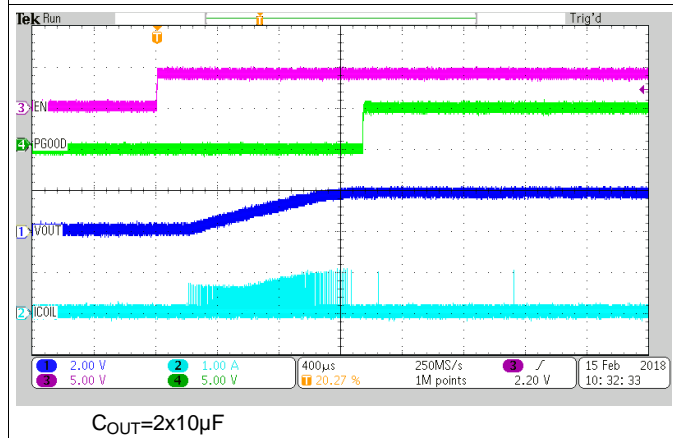

Figure 42. Startup at No Load

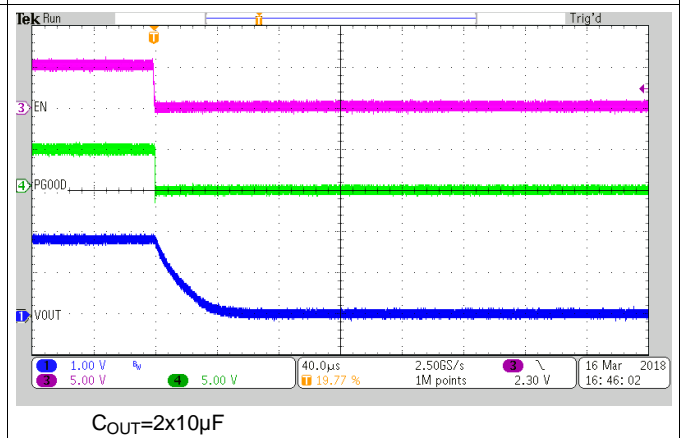
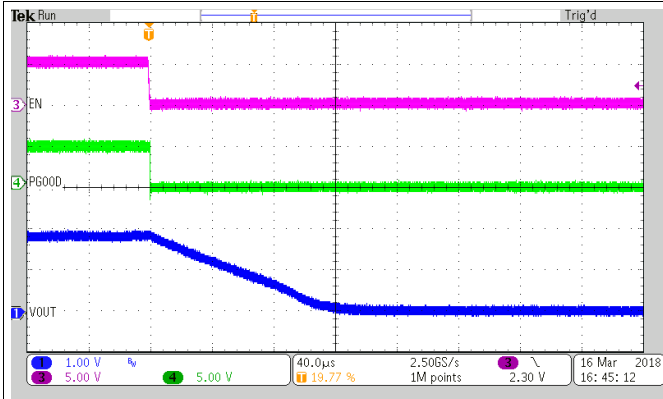
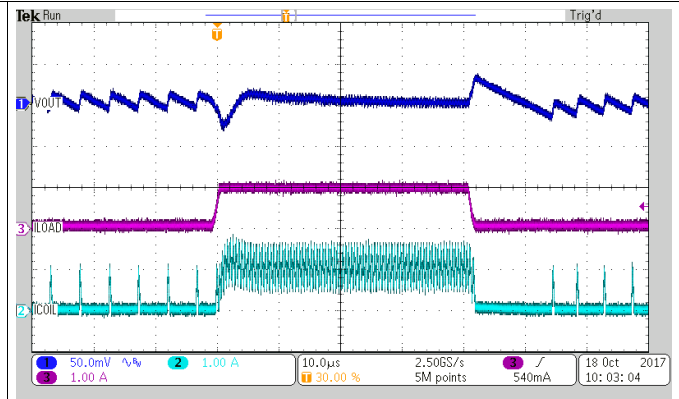

Figure 43. Active Output Discharge at load 1.8-Ohm



$C_{OUT}=2 \times 10 \mu F$

Figure 44. Active Output Discharge at No Load



$C_{OUT}=2 \times 10 \mu F$

$C_{ff}=120 pF$

Figure 45. Load Transient Response, 50mA to 1A, TPS62822

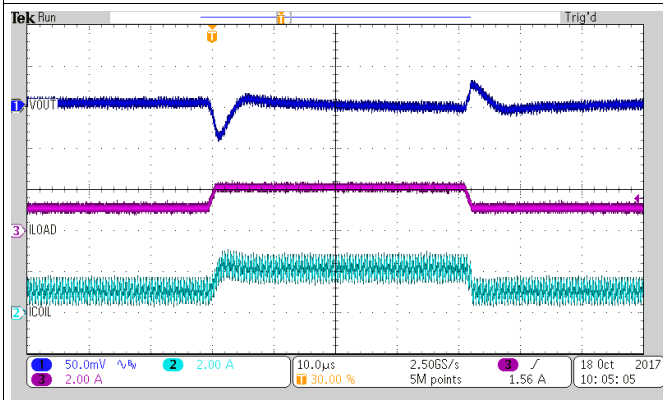

$C_{OUT}=2 \times 10 \mu F$

$C_{ff}=120 pF$

Figure 46. Load Transient Response, 1A to 2A, TPS62822

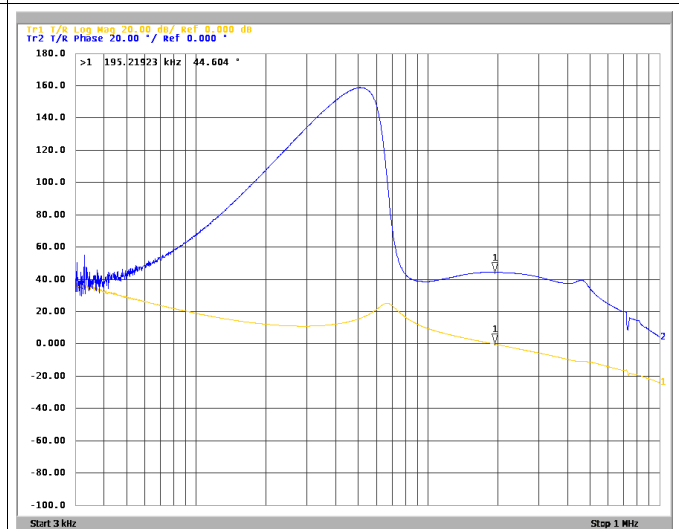

$C_{OUT}=2 \times 10 \mu F$

no  $C_{FF}$

Figure 47. Frequency Response (TPS62823), IOUT=3A

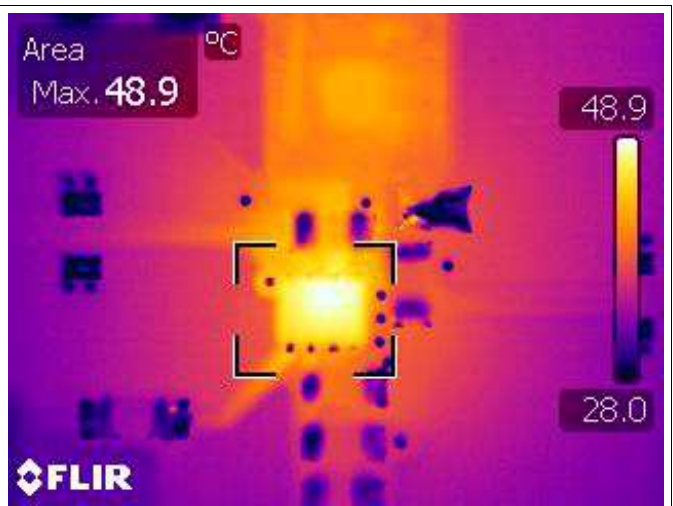
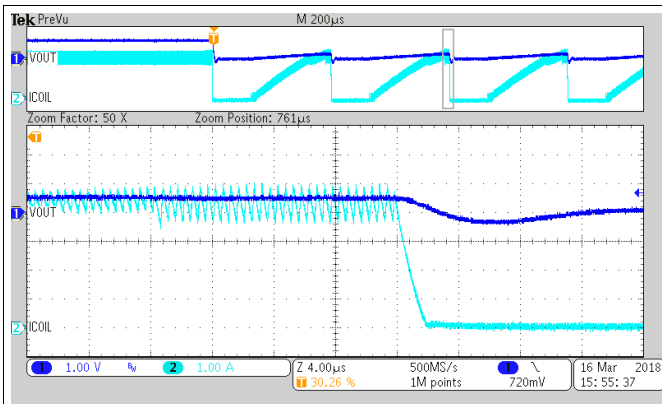
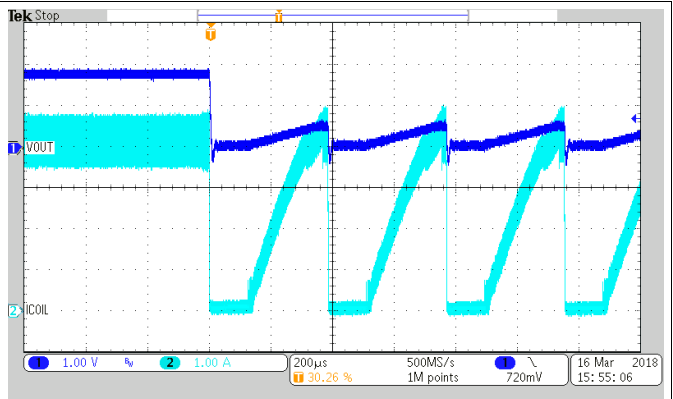
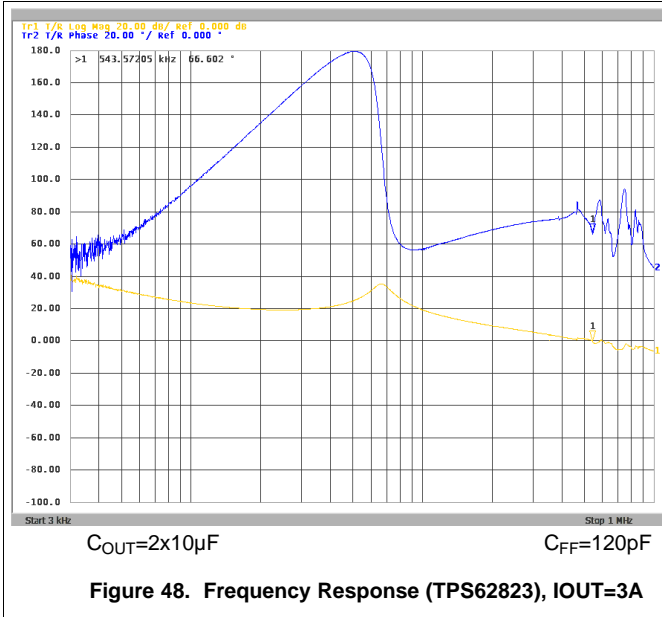

## 10 Power Supply Recommendations

The TPS6282x is designed to operate from a 2.4-V to 5.5-V input voltage supply. The input power supply's output current needs to be rated according to the output voltage and the output current of the power rail application.

## 11 Layout

### 11.1 Layout Guidelines

The recommended PCB layout for the TPS6282x is shown below. It ensures best electrical and optimized thermal performance considering the following important topics:

- The input capacitor(s) must be placed as close as possible to the VIN and PGND pins of the device. This provides low resistive and inductive paths for the high di/dt input current.
- The SW node connection from the IC to the inductor conducts alternating high currents. It should be kept short.

### Layout Guidelines (continued)

- The  $V_{OUT}$  regulation loop is closed with  $C_{OUT}$  and its ground connection. To avoid load regulation and EMI noise, the loop should be kept short.
- The FB node is sensitive to  $dv/dt$  signals. Therefore the resistive divider should be placed close to the FB and AGND pins.

For more detailed information about the actual EVM solution, see the [EVM users guide](#).

### 11.2 Layout Example

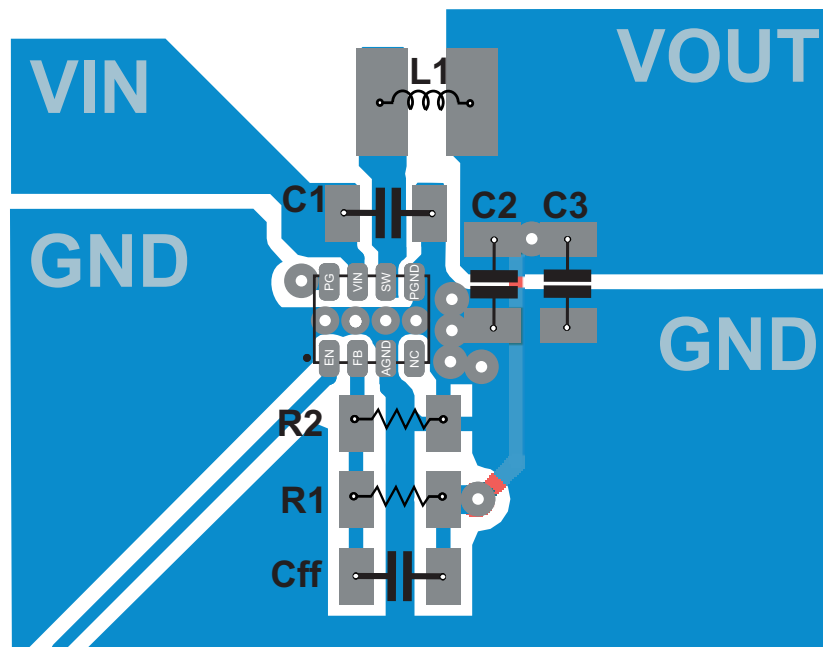

Figure 52. TPS6282x Board Layout

## 12 Device and Documentation Support

### 12.1 Device Support

#### 12.1.1 Third-Party Products Disclaimer

TI'S PUBLICATION OF INFORMATION REGARDING THIRD-PARTY PRODUCTS OR SERVICES DOES NOT CONSTITUTE AN ENDORSEMENT REGARDING THE SUITABILITY OF SUCH PRODUCTS OR SERVICES OR A WARRANTY, REPRESENTATION OR ENDORSEMENT OF SUCH PRODUCTS OR SERVICES, EITHER ALONE OR IN COMBINATION WITH ANY TI PRODUCT OR SERVICE.

### 12.2 Related Links

The table below lists quick access links. Categories include technical documents, support and community resources, tools and software, and quick access to order now.

**Table 5. Related Links**

| PARTS    | PRODUCT FOLDER             | ORDER NOW                  | TECHNICAL DOCUMENTS        | TOOLS & SOFTWARE           | SUPPORT & COMMUNITY        |
|----------|----------------------------|----------------------------|----------------------------|----------------------------|----------------------------|
| TPS62821 | <a href="#">Click here</a> | <a href="#">Click here</a> | <a href="#">Click here</a> | <a href="#">Click here</a> | <a href="#">Click here</a> |
| TPS62822 | <a href="#">Click here</a> | <a href="#">Click here</a> | <a href="#">Click here</a> | <a href="#">Click here</a> | <a href="#">Click here</a> |
| TPS62823 | <a href="#">Click here</a> | <a href="#">Click here</a> | <a href="#">Click here</a> | <a href="#">Click here</a> | <a href="#">Click here</a> |

### 12.3 Receiving Notification of Documentation Updates

To receive notification of documentation updates, navigate to the device product folder on ti.com. In the upper right corner, click on *Alert me* to register and receive a weekly digest of any product information that has changed. For change details, review the revision history included in any revised document.

### 12.4 Community Resources

[TI E2E™ support forums](#) are an engineer's go-to source for fast, verified answers and design help — straight from the experts. Search existing answers or ask your own question to get the quick design help you need.

Linked content is provided "AS IS" by the respective contributors. They do not constitute TI specifications and do not necessarily reflect TI's views; see TI's [Terms of Use](#).

### 12.5 Trademarks

DCS-Control, E2E are trademarks of Texas Instruments.  
All other trademarks are the property of their respective owners.

### 12.6 Electrostatic Discharge Caution



This integrated circuit can be damaged by ESD. Texas Instruments recommends that all integrated circuits be handled with appropriate precautions. Failure to observe proper handling and installation procedures can cause damage.

ESD damage can range from subtle performance degradation to complete device failure. Precision integrated circuits may be more susceptible to damage because very small parametric changes could cause the device not to meet its published specifications.

### 12.7 Glossary

[SLYZ022](#) — *TI Glossary*.

This glossary lists and explains terms, acronyms, and definitions.

## 13 Mechanical, Packaging, and Orderable Information

The following pages include mechanical, packaging, and orderable information. This information is the most current data available for the designated devices. This data is subject to change without notice and revision of this document. For browser-based versions of this data sheet, refer to the left-hand navigation.

**PACKAGING INFORMATION**

| Orderable Device | Status<br>(1) | Package Type | Package Drawing | Pins | Package Qty | Eco Plan<br>(2) | Lead finish/<br>Ball material<br>(6) | MSL Peak Temp<br>(3) | Op Temp (°C) | Device Marking<br>(4/5) | Samples                 |
|------------------|---------------|--------------|-----------------|------|-------------|-----------------|--------------------------------------|----------------------|--------------|-------------------------|-------------------------|
| TPS62821DLCR     | ACTIVE        | VSON-HR      | DLC             | 8    | 3000        | RoHS & Green    | Call TI   SN                         | Level-1-260C-UNLIM   | -40 to 125   | A1                      | <a href="#">Samples</a> |
| TPS62821DLCT     | ACTIVE        | VSON-HR      | DLC             | 8    | 250         | RoHS & Green    | Call TI   SN                         | Level-1-260C-UNLIM   | -40 to 125   | A1                      | <a href="#">Samples</a> |
| TPS62822DLCR     | ACTIVE        | VSON-HR      | DLC             | 8    | 3000        | RoHS & Green    | Call TI   SN                         | Level-1-260C-UNLIM   | -40 to 125   | A2                      | <a href="#">Samples</a> |
| TPS62822DLCT     | ACTIVE        | VSON-HR      | DLC             | 8    | 250         | RoHS & Green    | Call TI   SN                         | Level-1-260C-UNLIM   | -40 to 125   | A2                      | <a href="#">Samples</a> |
| TPS62823DLCR     | ACTIVE        | VSON-HR      | DLC             | 8    | 3000        | RoHS & Green    | Call TI   SN                         | Level-1-260C-UNLIM   | -40 to 125   | A3                      | <a href="#">Samples</a> |
| TPS62823DLCT     | ACTIVE        | VSON-HR      | DLC             | 8    | 250         | RoHS & Green    | Call TI   SN                         | Level-1-260C-UNLIM   | -40 to 125   | A3                      | <a href="#">Samples</a> |

(1) The marketing status values are defined as follows:

**ACTIVE:** Product device recommended for new designs.

**LIFEBUY:** TI has announced that the device will be discontinued, and a lifetime-buy period is in effect.

**NRND:** Not recommended for new designs. Device is in production to support existing customers, but TI does not recommend using this part in a new design.

**PREVIEW:** Device has been announced but is not in production. Samples may or may not be available.

**OBSELETE:** TI has discontinued the production of the device.

(2) **RoHS:** TI defines "RoHS" to mean semiconductor products that are compliant with the current EU RoHS requirements for all 10 RoHS substances, including the requirement that RoHS substance do not exceed 0.1% by weight in homogeneous materials. Where designed to be soldered at high temperatures, "RoHS" products are suitable for use in specified lead-free processes. TI may reference these types of products as "Pb-Free".

**RoHS Exempt:** TI defines "RoHS Exempt" to mean products that contain lead but are compliant with EU RoHS pursuant to a specific EU RoHS exemption.

**Green:** TI defines "Green" to mean the content of Chlorine (Cl) and Bromine (Br) based flame retardants meet JS709B low halogen requirements of <=1000ppm threshold. Antimony trioxide based flame retardants must also meet the <=1000ppm threshold requirement.

(3) MSL, Peak Temp. - The Moisture Sensitivity Level rating according to the JEDEC industry standard classifications, and peak solder temperature.

(4) There may be additional marking, which relates to the logo, the lot trace code information, or the environmental category on the device.

(5) Multiple Device Markings will be inside parentheses. Only one Device Marking contained in parentheses and separated by a "~" will appear on a device. If a line is indented then it is a continuation of the previous line and the two combined represent the entire Device Marking for that device.

(6) Lead finish/Ball material - Orderable Devices may have multiple material finish options. Finish options are separated by a vertical ruled line. Lead finish/Ball material values may wrap to two lines if the finish value exceeds the maximum column width.



**Important Information and Disclaimer:** The information provided on this page represents TI's knowledge and belief as of the date that it is provided. TI bases its knowledge and belief on information provided by third parties, and makes no representation or warranty as to the accuracy of such information. Efforts are underway to better integrate information from third parties. TI has taken and continues to take reasonable steps to provide representative and accurate information but may not have conducted destructive testing or chemical analysis on incoming materials and chemicals. TI and TI suppliers consider certain information to be proprietary, and thus CAS numbers and other limited information may not be available for release.

In no event shall TI's liability arising out of such information exceed the total purchase price of the TI part(s) at issue in this document sold by TI to Customer on an annual basis.

## GENERIC PACKAGE VIEW

**DLC 8**

**VSON-HR - 1 mm max height**

**2.0 x 1.5 mm, 0.5 mm pitch**

PLASTIC SMALL OUTLINE - NO LEAD

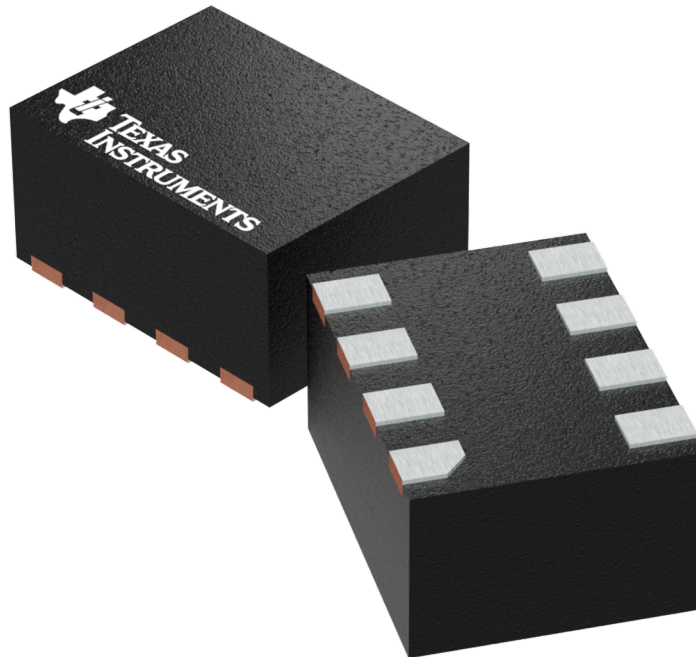

Images above are just a representation of the package family, actual package may vary.  
Refer to the product data sheet for package details.

4224379/A

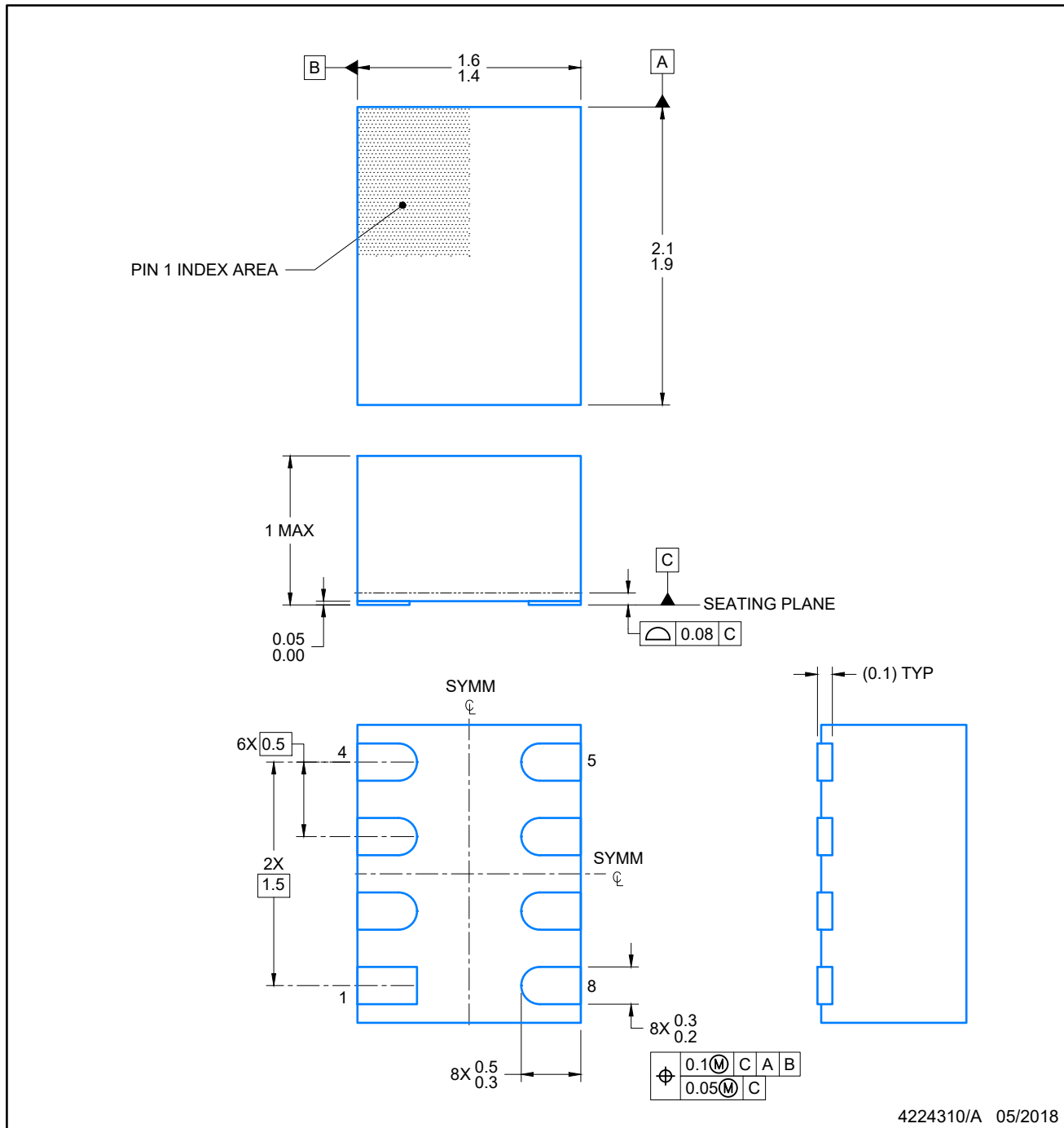

NOTES:

1. All linear dimensions are in millimeters. Any dimensions in parenthesis are for reference only. Dimensioning and tolerancing per ASME Y14.5M.
2. This drawing is subject to change without notice.

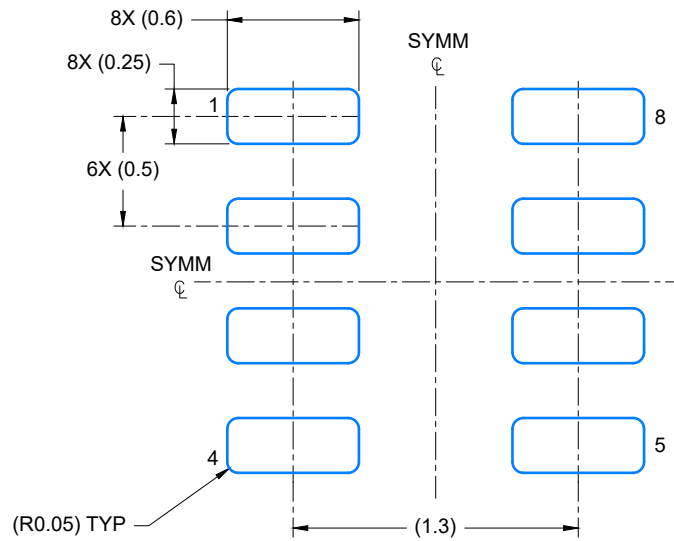

LAND PATTERN EXAMPLE  
EXPOSED METAL SHOWN  
SCALE: 30X

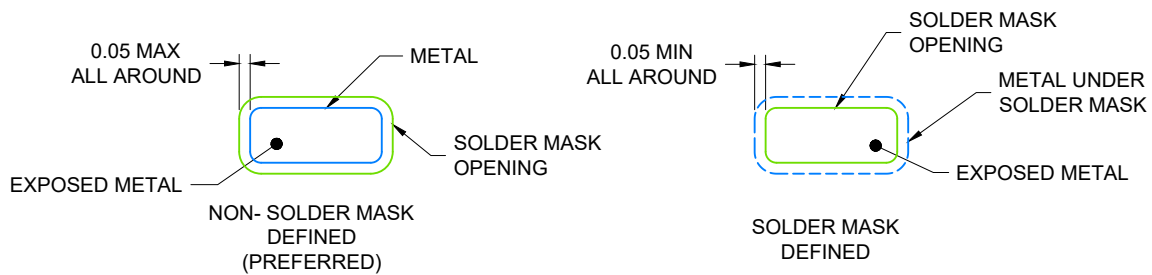

SOLDER MASK DETAILS

4224310/A 05/2018

NOTES: (continued)

- For more information, see Texas Instruments literature number SLUA271 ([www.ti.com/lit/sl原因271](http://www.ti.com/lit/sl原因271)).

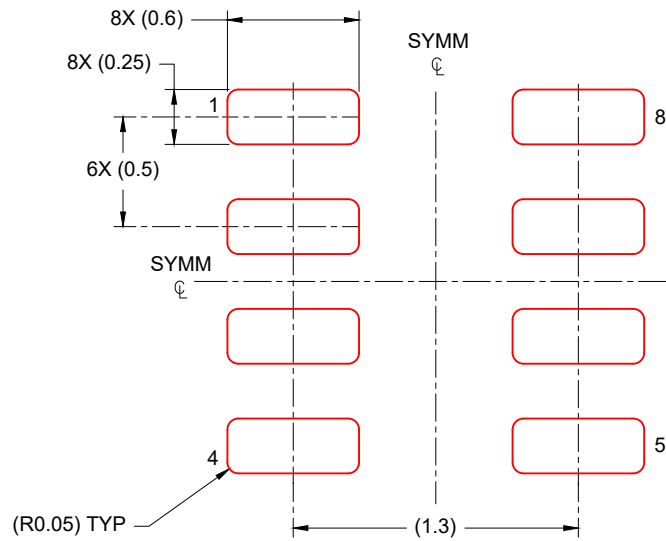

SOLDER PASTE EXAMPLE  
BASED ON 0.1 mm THICK STENCIL  
SCALE: 30X

4224310/A 05/2018

NOTES: (continued)

- 4. Laser cutting apertures with trapezoidal walls and rounded corners may offer better paste release. IPC-7525 may have alternate design recommendations.

## IMPORTANT NOTICE AND DISCLAIMER

TI PROVIDES TECHNICAL AND RELIABILITY DATA (INCLUDING DATA SHEETS), DESIGN RESOURCES (INCLUDING REFERENCE DESIGNS), APPLICATION OR OTHER DESIGN ADVICE, WEB TOOLS, SAFETY INFORMATION, AND OTHER RESOURCES "AS IS" AND WITH ALL FAULTS, AND DISCLAIMS ALL WARRANTIES, EXPRESS AND IMPLIED, INCLUDING WITHOUT LIMITATION ANY IMPLIED WARRANTIES OF MERCHANTABILITY, FITNESS FOR A PARTICULAR PURPOSE OR NON-INFRINGEMENT OF THIRD PARTY INTELLECTUAL PROPERTY RIGHTS.

These resources are intended for skilled developers designing with TI products. You are solely responsible for (1) selecting the appropriate TI products for your application, (2) designing, validating and testing your application, and (3) ensuring your application meets applicable standards, and any other safety, security, regulatory or other requirements.

These resources are subject to change without notice. TI grants you permission to use these resources only for development of an application that uses the TI products described in the resource. Other reproduction and display of these resources is prohibited. No license is granted to any other TI intellectual property right or to any third party intellectual property right. TI disclaims responsibility for, and you will fully indemnify TI and its representatives against, any claims, damages, costs, losses, and liabilities arising out of your use of these resources.

TI's products are provided subject to [TI's Terms of Sale](#) or other applicable terms available either on [ti.com](https://www.ti.com) or provided in conjunction with such TI products. TI's provision of these resources does not expand or otherwise alter TI's applicable warranties or warranty disclaimers for TI products.

TI objects to and rejects any additional or different terms you may have proposed.

Mailing Address: Texas Instruments, Post Office Box 655303, Dallas, Texas 75265  
Copyright © 2024, Texas Instruments Incorporated