

TPS621x0 Buck Converter Evaluation Module User's Guide



ABSTRACT

This user's guide describes the characteristics, operation, and use of the Texas Instruments TPS62160 and TPS62170 evaluation modules (EVM). These EVMs are designed to help the user easily evaluate and test the operation and functionality of the TPS62160 and TPS62170. This user's guide includes setup instructions for the hardware, printed-circuit board layouts for the EVMs, a schematic diagram, a bill of materials, and test results for the EVMs.

Table of Contents

1 Introduction	2
1.1 Background.....	2
1.2 Performance Specification.....	2
1.3 Modifications.....	2
2 Setup	4
2.1 Input/Output Connector Descriptions.....	4
2.2 Setup.....	4
3 TPS621x0EVM-627 Test Results	5
4 Board Layout	11
5 Schematic and Bill of Materials	13
5.1 Schematic.....	13
5.2 Bill of Materials.....	14
6 Revision History	14

List of Figures

Figure 1-1. Loop Response Measurement Modification.....	3
Figure 3-1. Efficiency.....	5
Figure 3-2. Load Regulation.....	5
Figure 3-3. Line Regulation With $I_{out} = 0.5\text{ A}$	5
Figure 3-4. Loop Response With $V_{in} = 12\text{ V}$ and $I_{out} = 0.5\text{ A}$	6
Figure 3-5. Input Voltage Ripple With $V_{in} = 12\text{ V}$ and $I_{out} = 1\text{ A}$	6
Figure 3-6. Output Voltage Ripple With $V_{in} = 12\text{ V}$ and $I_{out} = 1\text{ A}$	7
Figure 3-7. Load Transient Response With $V_{in} = 12\text{ V}$	7
Figure 3-8. Start-Up on V_{in} With 0.5-A Load.....	8
Figure 3-9. Start-Up on EN with 0.5-A Load.....	8
Figure 3-10. Shutdown on EN With 0.5-A Load.....	9
Figure 3-11. Prebias Start-Up and Shutdown on EN With 0.5-A Load.....	9
Figure 3-12. Thermal Performance With $V_{in} = 12\text{ V}$ and $I_{out} = 1\text{ A}$	10
Figure 4-1. Assembly Layer.....	11
Figure 4-2. Top Layer Routing.....	11
Figure 4-3. Bottom Layer Routing.....	12
Figure 5-1. TPS621x0EVM-627 Schematic.....	13

List of Tables

Table 1-1. Performance Specification Summary.....	2
Table 5-1. TPS621x0EVM-627 Bill of Materials.....	14

1 Introduction

The TPS62160 is a 1-A, synchronous, step-down converter in a 2x2-mm, 8-pin WSON package. Both fixed and adjustable output voltage units are available.

The TPS62170 is a 0.5-A, synchronous, step-down converter in a 2x2-mm, 8-pin WSON package. Both fixed and adjustable output voltage units are available.

1.1 Background

The TPS62160EVM-627 (HPA627-001) uses the TPS62160 adjustable version and is set to a 3.3-V output. The EVM operates with full-rated performance with an input voltage between 3.7 V and 17 V.

The TPS62170EVM-627 (HPA627-002) uses the TPS62170 adjustable version and is set to a 3.3-V output. The EVM operates with full-rated performance with an input voltage between 3.7 V and 17 V.

1.2 Performance Specification

[Table 1-1](#) provides a summary of the TPS621x0EVM-627 performance specifications. All specifications are given for an ambient temperature of 25°C.

Table 1-1. Performance Specification Summary

Specification	Test Conditions	Min	Typ	Max	Unit
Input Voltage		3.7		17	V
Output Voltage	PWM Mode of Operation	3.227	3.327	3.427	V
Output Current	TPS62160EVM-627	0		1000	mA
	TPS62170EVM-627	0		500	mA
Peak Efficiency			93.1%		
Soft-Start Time			180		μs

1.3 Modifications

The printed-circuit board (PCB) for this EVM is designed to accommodate both the fixed and adjustable voltage versions of this integrated circuit (IC). Additional input and output capacitors can also be added. Finally, the loop response of the IC can be measured.

1.3.1 Fixed Output Operation

U1 can be replaced with the fixed-voltage version of the IC for evaluation. For fixed-voltage version operation, replace R2 with a 0-Ω resistor and remove R1.

1.3.2 Input and Output Capacitors

C4 is provided for an additional input capacitor. This capacitor is not required for proper operation but can be used to reduce the input voltage ripple.

C3 is provided for an additional output capacitor. This capacitor is not required for proper operation but can be used to reduce the output voltage ripple and to improve the load transient response. The total output capacitance must remain within the recommended range in the data sheet for proper operation.

1.3.3 Loop Response Measurement

The loop response of the TPS621x0EVM-627 can be measured with two simple changes to the circuitry. First, install a 10-Ω resistor across the pads in the middle of the back of the PCB. The pads are spaced to allow installation of 0805- or 0603-sized resistors. Second, cut the short section of trace between the via on the output voltage and the trace that connects to the VOS pin via. These changes are shown in [Figure 1-1](#). With these changes, an ac signal (10-mV, peak-to-peak amplitude recommended) can be injected into the control loop across the added resistor.

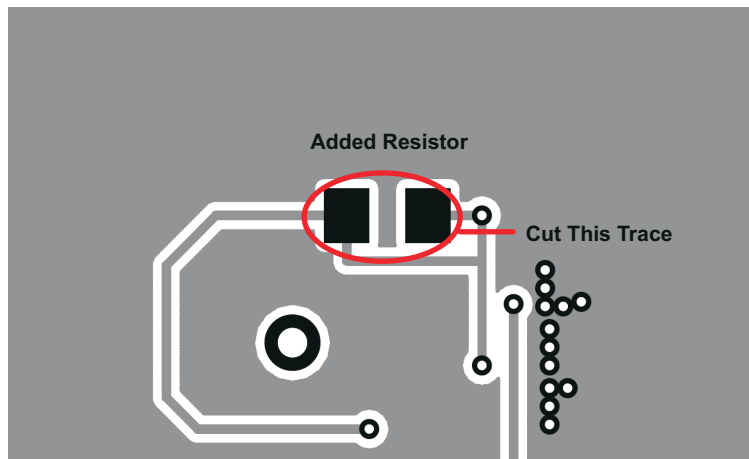

Figure 1-1. Loop Response Measurement Modification

2 Setup

This section describes how to properly use the TPS621x0EVM-627.

2.1 Input/Output Connector Descriptions

J1 – VIN	Positive input connection from the input supply for the EVM.
J2 – S+/S-	Input voltage sense connections. Measure the input voltage at this point.
J3 – GND	Return connection from the input supply for the EVM.
J4 – VOUT	Output voltage connection.
J5 – S+/S-	Output voltage sense connections. Measure the output voltage at this point.
J6 – GND	Output return connection.
J7 – PG/GND	The PG output appears on pin 1 of this header with a convenient ground on pin 2.
JP1 – EN	EN pin input jumper. Place the supplied jumper across ON and EN to turn on the IC. Place the jumper across OFF and EN to turn off the IC.
JP2 – PG Pullup Voltage	PG pin pullup voltage jumper. Place the supplied jumper on JP2 to connect the PG pin pullup resistor to Vout. Alternatively, the jumper can be removed and a different voltage can be supplied on pin 1 to pull up the PG pin to a different level. This externally applied voltage must remain below 7 V.

2.2 Setup

To operate the EVM, set jumpers JP1 through JP2 to the desired positions per [Section 2.1](#). Connect the input supply to J1 and J3 and connect the load to J4 and J6.

3 TPS621x0EVM-627 Test Results

This section provides test results of the TPS621x0EVM-627.

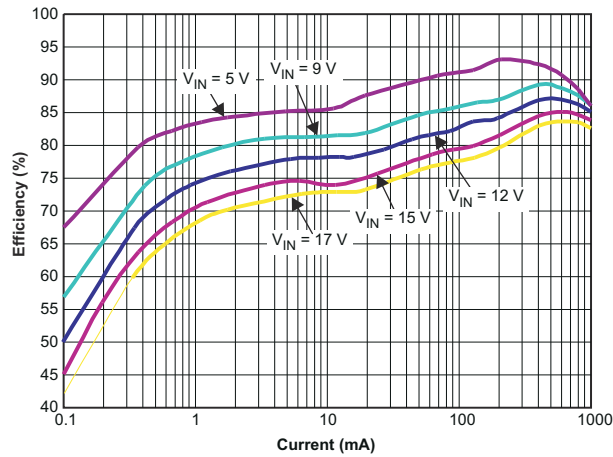

Figure 3-1. Efficiency

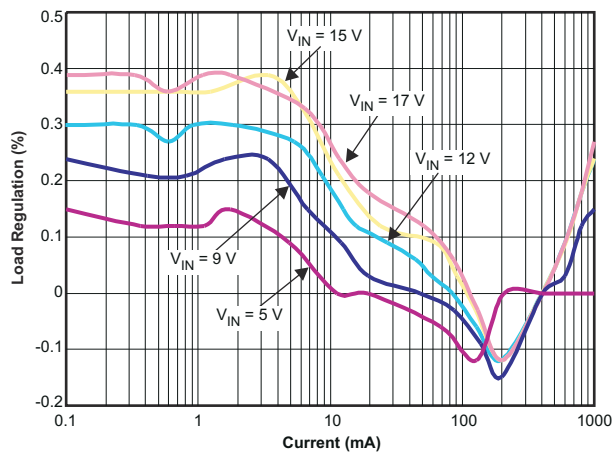

Figure 3-2. Load Regulation

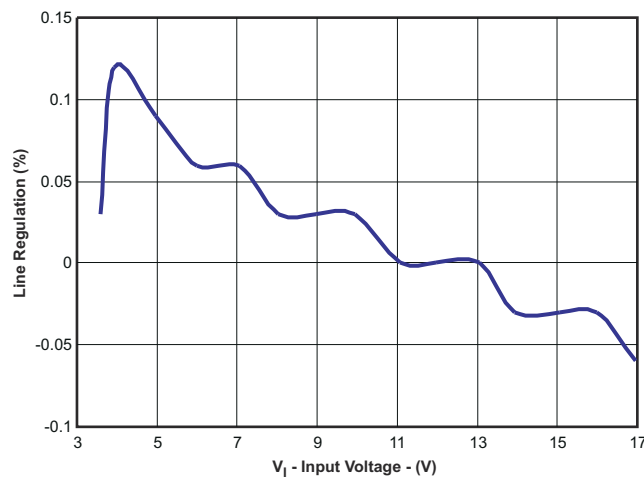

Figure 3-3. Line Regulation With I_{out} = 0.5 A

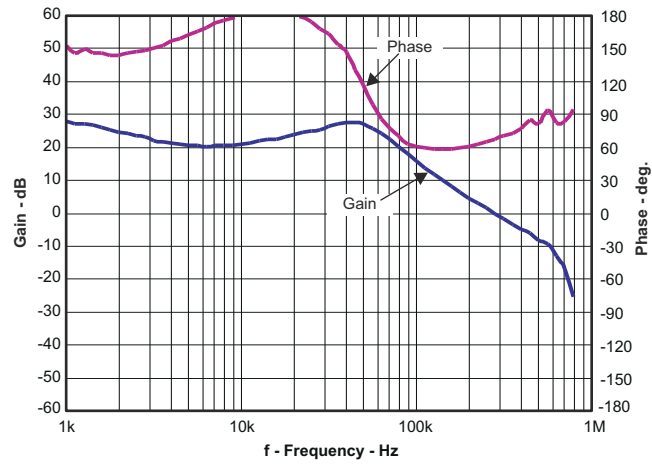

Figure 3-4. Loop Response With $V_{in} = 12\text{ V}$ and $I_{out} = 0.5\text{ A}$

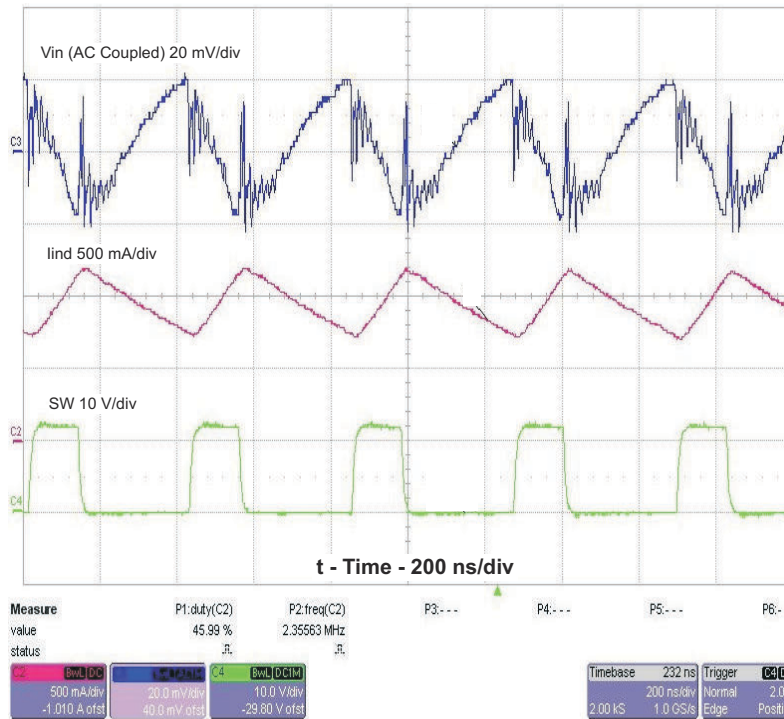

Figure 3-5. Input Voltage Ripple With $V_{in} = 12\text{ V}$ and $I_{out} = 1\text{ A}$

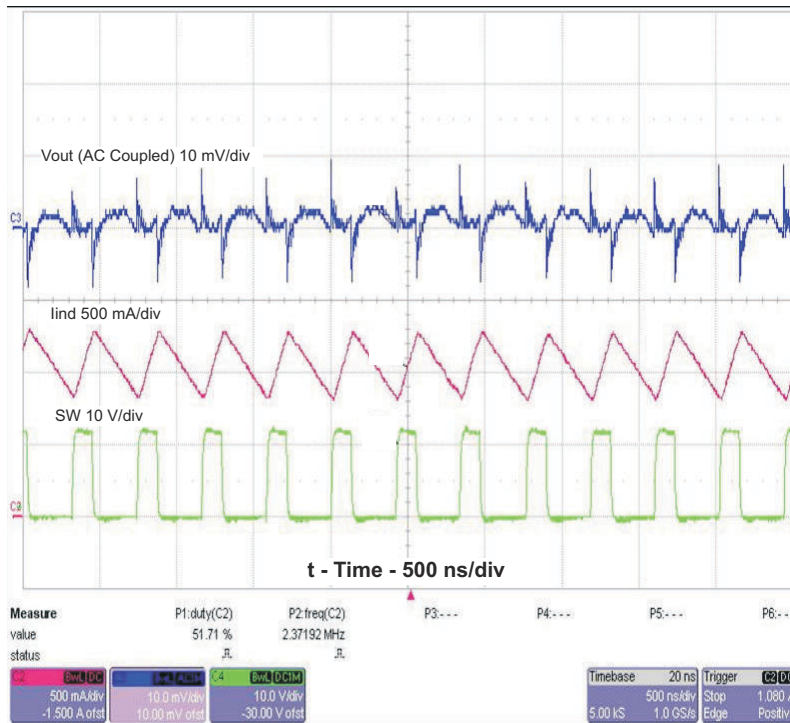

Figure 3-6. Output Voltage Ripple With $V_{in} = 12\text{ V}$ and $I_{out} = 1\text{ A}$

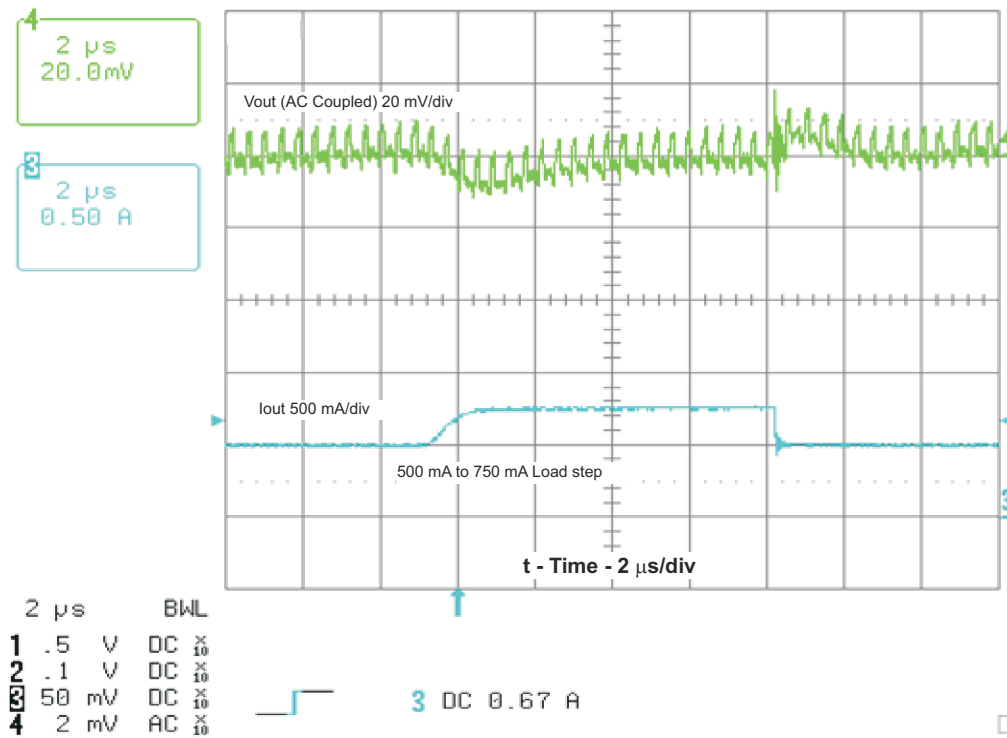

Figure 3-7. Load Transient Response With $V_{in} = 12\text{ V}$

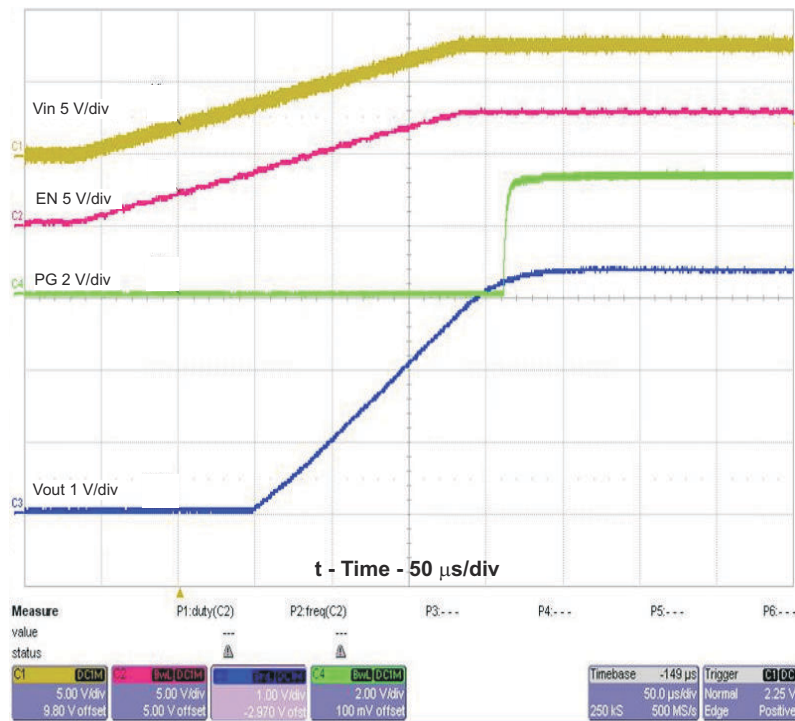

Figure 3-8. Start-Up on Vin With 0.5-A Load

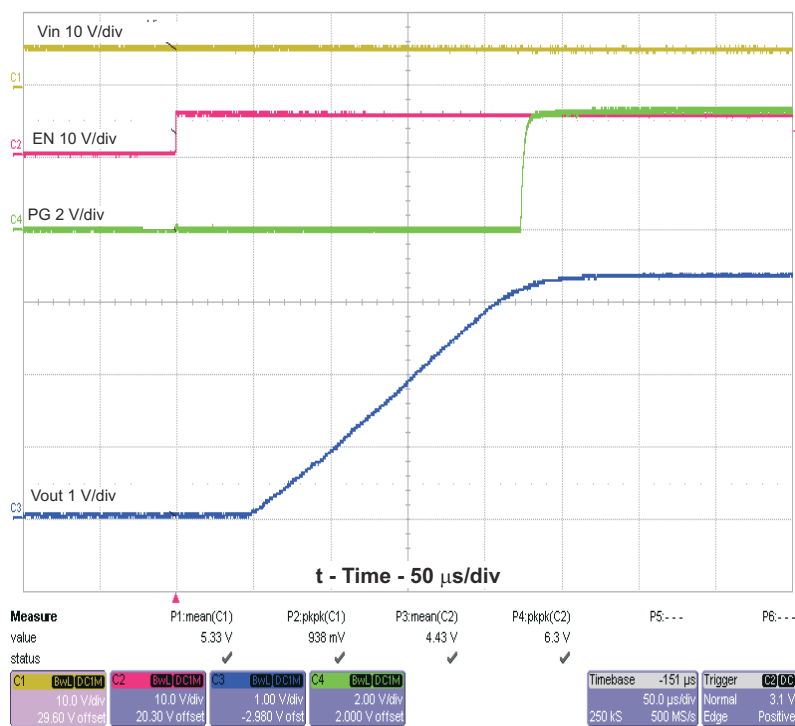

Figure 3-9. Start-Up on EN with 0.5-A Load

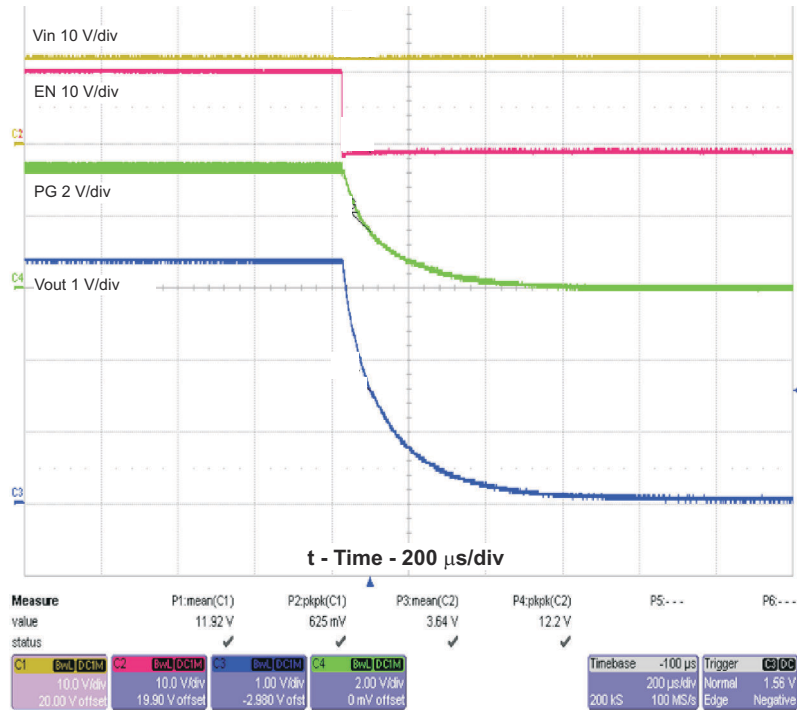

Figure 3-10. Shutdown on EN With 0.5-A Load

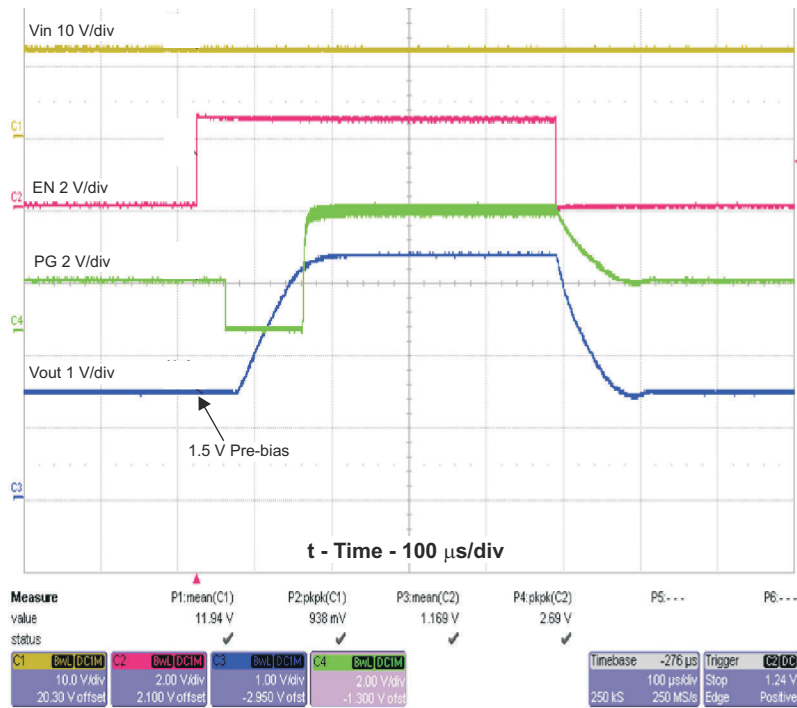

Figure 3-11. Prebias Start-Up and Shutdown on EN With 0.5-A Load

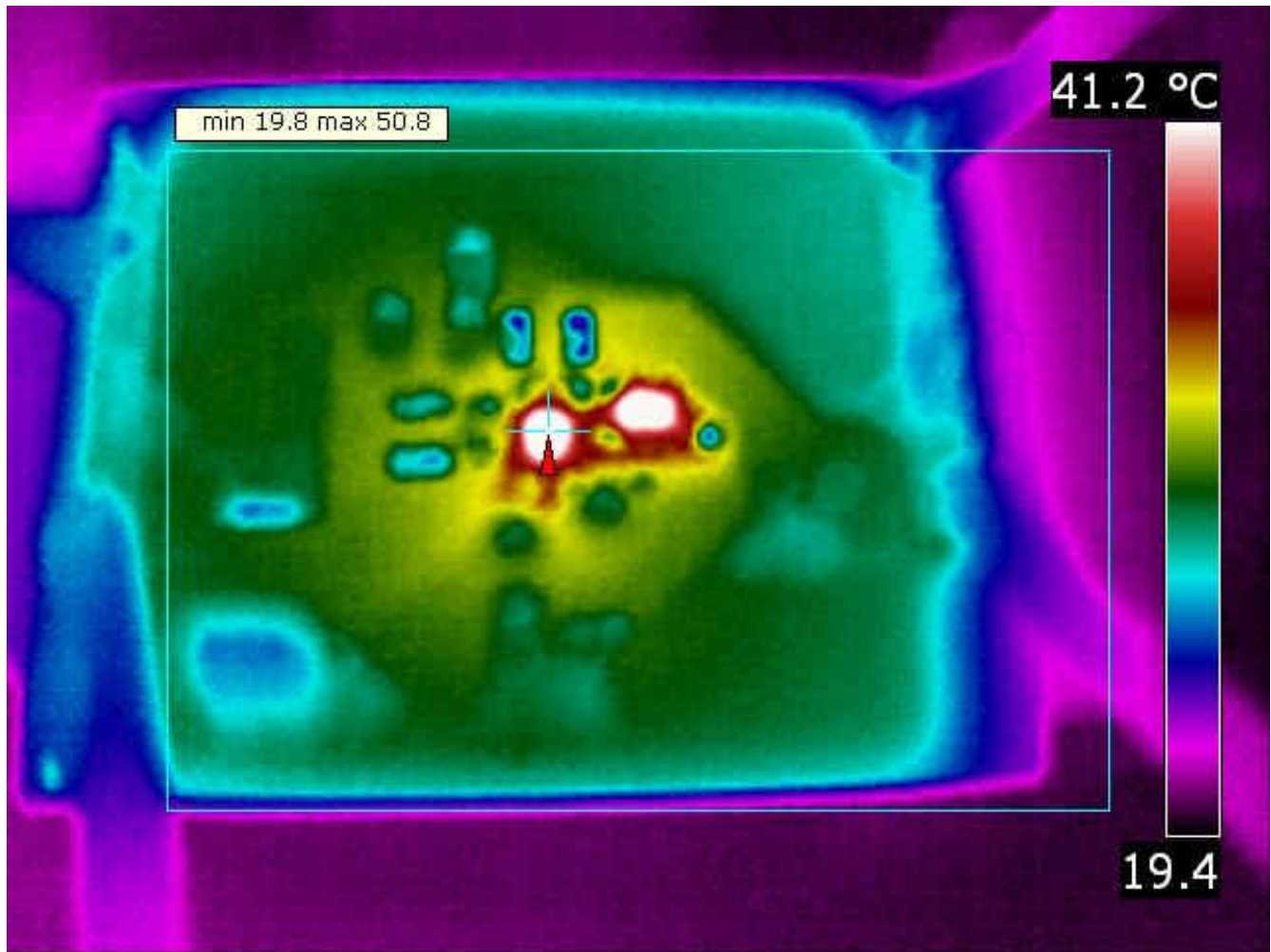

Figure 3-12. Thermal Performance With $V_{in} = 12\text{ V}$ and $I_{out} = 1\text{ A}$

4 Board Layout

This section provides the TPS621x0EVM-627 board layout and illustrations.

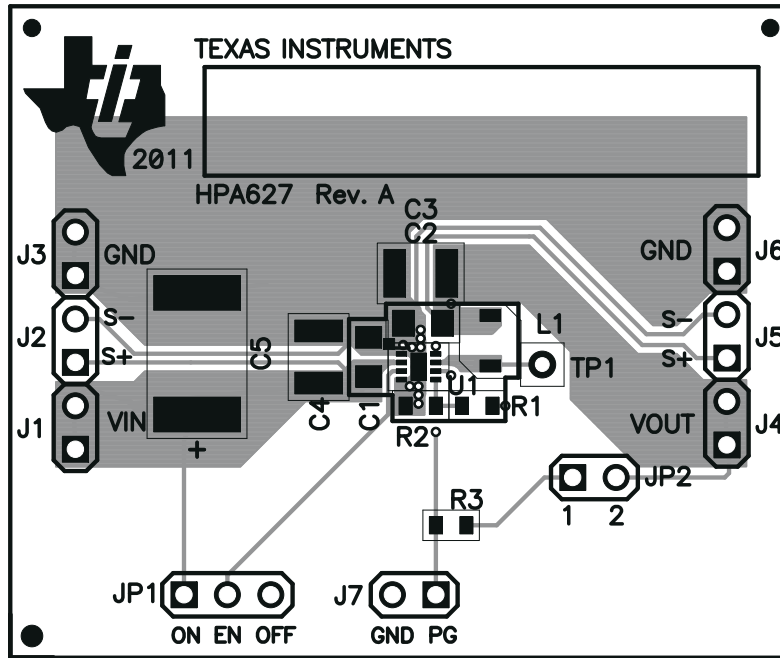

Figure 4-1. Assembly Layer

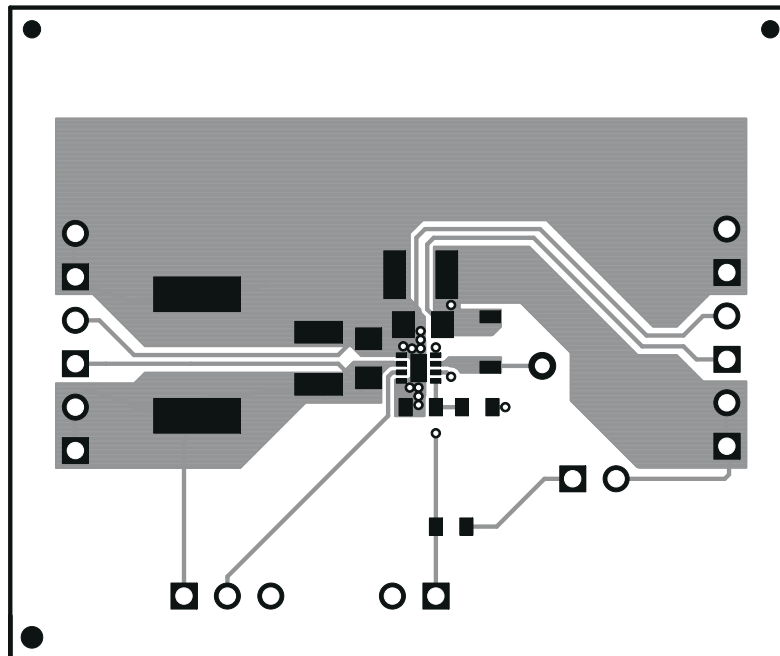

Figure 4-2. Top Layer Routing

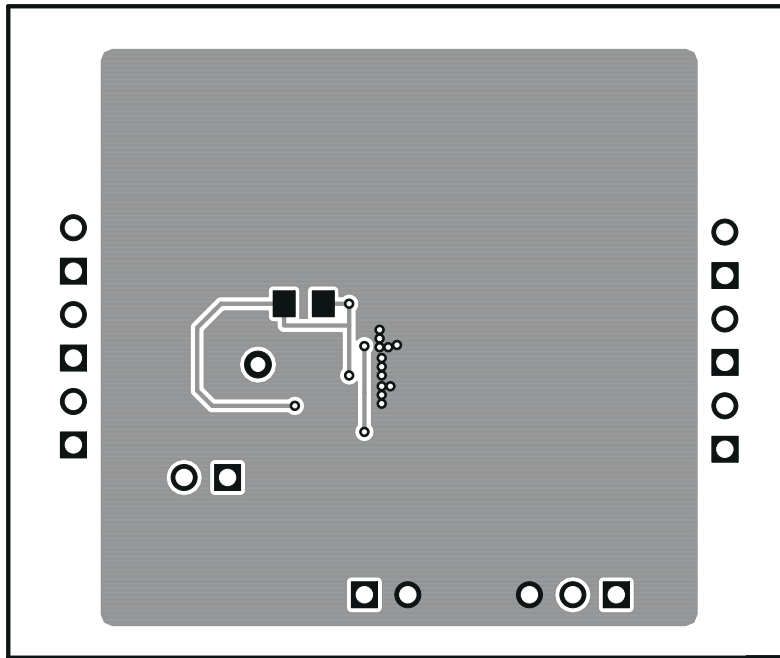

Figure 4-3. Bottom Layer Routing

5 Schematic and Bill of Materials

This section provides the TPS621x0EVM-627 schematic and bill of materials.

5.1 Schematic

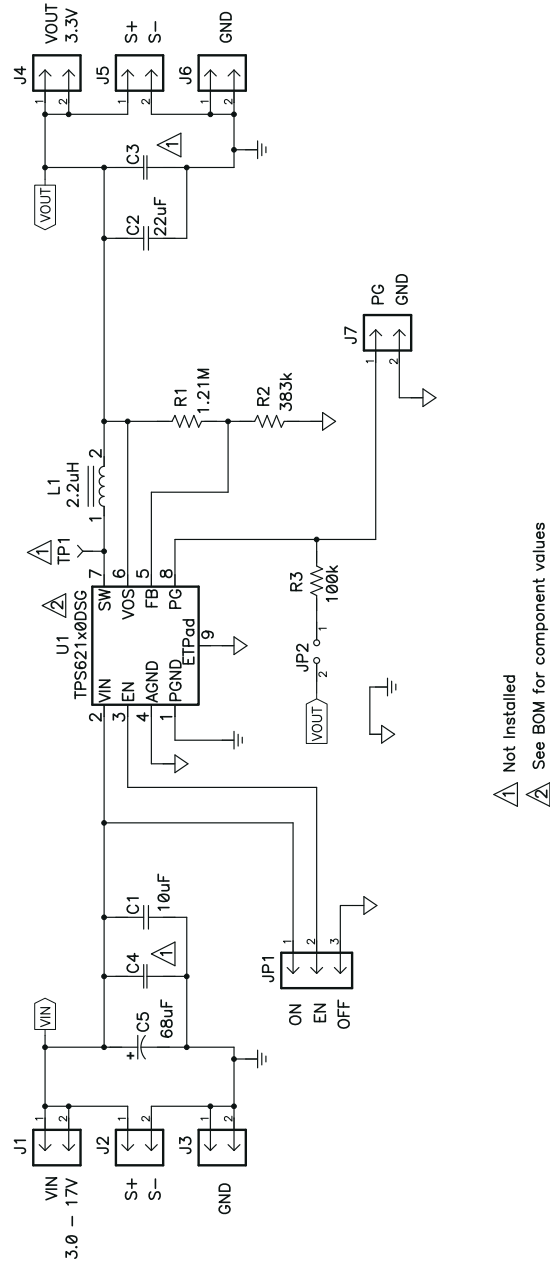

Figure 5-1. TPS621x0EVM-627 Schematic

5.2 Bill of Materials

Table 5-1. TPS621x0EVM-627 Bill of Materials

Count		RefDes	Value	Description	Size	Part Number	MFR
-001	-002						
1	1	C1	10 μ F	Capacitor, Ceramic, 25V, X5R, 20%	0805	Std	Std
1	1	C2	22 μ F	Capacitor, Ceramic, 6.3V, X5R, 20%	0805	Std	Std
1	1	C5	68 μ F	Capacitor, Tantalum, 35V, 68 μ F, \pm 20%	7361[V]	TPSV686M035R0150	AVX
1	1	L1	2.2 μ H	Inductor, SMT, 2.2 uH, 1.4A, 60-milliohm	2.80 X 3.00 mm	VLF3012ST-2R2M1R4	TDK
1	1	R1	1.21M	Resistor, Chip, 1/16W, 1%	0603	Std	Std
1	1	R2	383k	Resistor, Chip, 1/16W, 1%	0603	Std	Std
1	1	R3	100k	Resistor, Chip, 1/16W, 1%	0603	Std	Std
1	0	U1	TPS62160DSG	IC, 17V 1A Buck Converter	2 x 2 mm WSON	TPS62160DSG	TI
0	1	U1	TPS62170DSG	IC, 17V 0.5A Buck Converter	2 x 2 mm WSON	TPS62170DSG	TI

6 Revision History

NOTE: Page numbers for previous revisions may differ from page numbers in the current version.

Changes from Revision * (October 2011) to Revision A (June 2021) Page

- Updated user's guide title..... 2
- Updated the numbering format for tables, figures, and cross-references throughout the document.2

IMPORTANT NOTICE AND DISCLAIMER

TI PROVIDES TECHNICAL AND RELIABILITY DATA (INCLUDING DATA SHEETS), DESIGN RESOURCES (INCLUDING REFERENCE DESIGNS), APPLICATION OR OTHER DESIGN ADVICE, WEB TOOLS, SAFETY INFORMATION, AND OTHER RESOURCES "AS IS" AND WITH ALL FAULTS, AND DISCLAIMS ALL WARRANTIES, EXPRESS AND IMPLIED, INCLUDING WITHOUT LIMITATION ANY IMPLIED WARRANTIES OF MERCHANTABILITY, FITNESS FOR A PARTICULAR PURPOSE OR NON-INFRINGEMENT OF THIRD PARTY INTELLECTUAL PROPERTY RIGHTS.

These resources are intended for skilled developers designing with TI products. You are solely responsible for (1) selecting the appropriate TI products for your application, (2) designing, validating and testing your application, and (3) ensuring your application meets applicable standards, and any other safety, security, regulatory or other requirements.

These resources are subject to change without notice. TI grants you permission to use these resources only for development of an application that uses the TI products described in the resource. Other reproduction and display of these resources is prohibited. No license is granted to any other TI intellectual property right or to any third party intellectual property right. TI disclaims responsibility for, and you will fully indemnify TI and its representatives against, any claims, damages, costs, losses, and liabilities arising out of your use of these resources.

TI's products are provided subject to [TI's Terms of Sale](#) or other applicable terms available either on ti.com or provided in conjunction with such TI products. TI's provision of these resources does not expand or otherwise alter TI's applicable warranties or warranty disclaimers for TI products.

TI objects to and rejects any additional or different terms you may have proposed.

Mailing Address: Texas Instruments, Post Office Box 655303, Dallas, Texas 75265
Copyright © 2022, Texas Instruments Incorporated