

bq50002 Wireless Power TX EVM

The bqTESLA™ wireless power transmitter evaluation module from Texas Instruments is a high-performance, easy-to-use development module for the design of wireless power solutions. The bq50002 evaluation module (EVM) provides all the basic functions of a Qi-compliant, wireless charger pad. The 5-V input, single coil transmitter enables designers to speed the development of their end-applications. The EVM supports both the Qi WPC 1.0, WPC 1.1, and WPC 1.2 receivers and will support output power up to 5 W.

Contents

1	Applications.....	2
2	bq50002EVM-607 Electrical Performance Specifications	2
3	Modifications.....	3
4	Connector and Test Point Descriptions	3
	4.1 Input/Output Connections.....	3
	4.2 Test Point Descriptions	4
5	Schematic and Bill of Materials	8
6	Test Setup.....	11
	6.1 Equipment.....	11
	6.2 Equipment Setup	12
	6.3 EVM Procedure.....	13
7	bq50002EVM-607 Assembly Drawings and Layout	18
8	Reference	20

List of Figures

1	bq50002EVM-607 Schematic	8
2	Connections of the EV2400 kit	13
3	bqStudio Window.....	14
4	Device ID	14
5	Efficiency vs Power, bq50002EVM-607 TX and bq51013BEVM-764 Receiver.....	16
6	Start Up.....	16
7	Thermal Performance.....	17
8	Assembly Top.....	18
9	Inner Layer 1	19
10	Inner Layer 2.....	19
11	Bottom Layer.....	20

List of Tables

1	bq50002EVM-607 Electrical Performance Specifications	2
2	Bill of Materials	9

1 Applications

The bq50002EVM-607 evaluation module demonstrates the transmitter portion of the bqTESLA™ wireless power system. This transmitter EVM is a complete transmitter-side solution that powers a bqTESLA receiver. The EVM requires a single 5-V power supply capable of up to 2.0 A to operate and combines the transmitter electronics, input power circuit, LED indicators, and the transmitting coil on the single printed-circuit board (PCB). The open design allows easy access to key points of the electrical schematic.

This EVM has the following features:

- Qi-Certified WPC 1.2 solution for 5-W operation
- 5-V input and fixed operation voltage
- Enhanced Foreign Object Detection (FOD)
- WPC 1.2 FOD
- Transmitter-coil mounting pad providing the correct receiver interface
- Highly-integrated analog front end including LDO, FETs, drivers, current sense amplifier, and demodulation circuit
- Standard WPC A11-type transmitter coil with no magnet
- LED and audio indication of power transfer

2 bq50002EVM-607 Electrical Performance Specifications

Table 1 provides a summary of the EVM performance specifications. All specifications are given for an ambient temperature of 25°C.

Table 1. bq50002EVM-607 Electrical Performance Specifications

Parameter		Notes and Conditions	Min	Typ	Max	Unit
Input Characteristics						
V_{IN}	Input voltage		4.5	5	5.5	V
I_{IN}	Input current	$V_{IN} = \text{Nom}$, $I_{OUT} = 1 \text{ A}$ at 5 V		1.4		A
	Input no-load current	$V_{IN} = \text{Nom}$, $I_{OUT} = 0 \text{ A}$		165		mA
	Input stand-by current	$V_{IN} = \text{Nom}$		4		mA
Output Characteristics – Receiver bq51013BEVM-764						
V_{OUT}	Output voltage	$V_{IN} = \text{Nom}$, $I_{OUT} = 1 \text{ A}$, $V_{OUT} = 5 \text{ V}$	4.95	5.00	5.04	V
	Output ripple	$V_{IN} = \text{Nom}$, $I_{OUT} = 1.0 \text{ A}$, $V_{OUT} = 5 \text{ V}$			200	mV _{PP}
I_{OUT}	$V_{IN} = \text{Min to Max}$	$V_{IN} = \text{Min to Max}$, $V_{OUT} = 5 \text{ V}$	0		1.5	A
Systems Characteristics						
F_s	Switching frequency	During power transfer	110		205	kHz
η_{pk}	Peak efficiency	$V_{IN} = \text{Nom}$, P Out RX = 3 W		74		%
η	Full-load efficiency	$V_{IN} = \text{Nom}$, $I_{OUT} = \text{Max}$		71		%

3 Modifications

See the datasheet ([SLUSBW1](#)) when changing components.
FOD – R27 threshold and R26 FOD_Cal (see [Section 6.3.9](#))

4 Connector and Test Point Descriptions

4.1 Input/Output Connections

The connection points are described in [Section 4.1.1](#) through [Section 4.1.4](#).

4.1.1 J1 – V_{IN}

Input power 5 V \pm 500 mV, return at J3.

4.1.2 J2 – USB Input

USB input connection.

4.1.3 J3 –GND

Return for input power, input at J1.

4.1.4 J4 – Serial Interface

I²C interface connection to communicate with the IC. Used with bqStudio tool to monitor behavior

4.2 Test Point Descriptions

The test points are described in [Section 4.2.1](#) through [Section 4.2.56](#).

4.2.1 TP1 – CS+

Current sense amplifier positive input.

4.2.2 TP2 – CS–

Current sense amplifier negative input.

4.2.3 TP3 – V_{IN}

Input power, 5 V ±500 mV.

4.2.4 TP4 – GND

Return for input power.

4.2.5 TP5 –DMIN1

Modulation signal input from coil for DEMOD Channel 1.

4.2.6 TP6 –SW1

Switch node of the half bridge MOSFETs.

4.2.7 TP7 – GND

Low-noise ground test point (TP).

4.2.8 TP8 –Low-Noise Analog Ground

Low-noise ground TP.

4.2.9 TP9 – GND

Low-noise ground TP.

4.2.10 TP10 – GND

Low-noise ground TP.

4.2.11 TP11 – PGND

Return for SW1.

4.2.12 TP12 – DMIN2

Modulation signal input from coil for DEMOD Channel 2.

4.2.13 TP13 – PEAK

Peak detection.

4.2.14 TP14 – SW2

Switch node of the half-bridge MOSFETs.

4.2.15 TP15 – BP3

Output of 3-V LDO.

4.2.16 TP16 – TANK

Coil signal at junction between transmitter coil and resonant capacitors.

4.2.17 TP17 – PGND

Return for SW2.

4.2.18 TP18 – PWM1/CLK

Input to control half-bridge MOSFETs connected to SW1 when PWM_CTRL is high. The operating frequency/pulse width changes up or down depending on every rising edge of this periodic signal when PWM_CTRL is low.

4.2.19 TP19 – PWM2/UPDN

Input to control half-bridge MOSFETs connected to SW2 when PWM_CTRL is high. Increase or decrease power transfer when PWM_CTRL is low.

4.2.20 TP20 – CSO

Output of the current sense amplifier.

4.2.21 TP21 – DMOUT1

Demodulated 2-kHz bit stream from demodulation channel 1.

4.2.22 TP22 – DMOUT2

Demodulated 2-kHz bit stream from demodulation channel 2.

4.2.23 TP23 – BUZZ

DC output when power transfer is started. Can be used to drive a DC style buzzer or LED. See data sheet for more information.

4.2.24 TP24 – LED_B

Status indication, typically RED.

4.2.25 TP25 – LED_A

Status indication, typically GREEN.

4.2.26 TP26 – LED_C

Status indication, typically ORANGE.

4.2.27 TP27 – LED_MODE

LED mode selection.

4.2.28 TP28 – T_SENSE

Temperature sensing for safety shutdown.

4.2.29 TP29 – FOD_CAL

FOD calibration.

4.2.30 TP30 – FOD_THR

FOD threshold.

4.2.31 TP31 – V_SENSE

Input voltage sense.

4.2.32 TP32 – FLIM

Leave floating to conform to WPC specification 205-kHz maximum operating frequency.

4.2.33 TP33 – ILIM

ILIM can be used to restrict the input current in order to operate with a limited input voltage source. Leave this pin open if no fixed current limit should be used.

4.2.34 TP34 – Reserved IC Pin 5

Unused.

4.2.35 TP35 – Unused IC Pin 7

Leave this pin open.

4.2.36 TP36 – Unused IC Pin 25

Leave this pin open.

4.2.37 TP37 – Unused IC Pin 27

Leave this pin open.

4.2.38 TP38 - Unused IC Pin 17

Leave this pin open.

4.2.39 TP39 - Unused IC Pin 6

Leave this pin open.

4.2.40 TP40 - Unused IC Pin 24

Leave this pin open.

4.2.41 TP41 - Unused IC Pin 26

Leave this pin open.

4.2.42 TP42 - Unused IC Pin 18

Leave this pin open.

4.2.43 TP43 – CLK_IN

CLK_OUT signal from the internal oscillator of the bq50002.

4.2.44 TP44 – MODE

Control of frequency/pulse width of the internal generated oscillator signal.

4.2.45 TP45 – SDA

I²C data.

4.2.46 TP46 – SCL

I²C clock.

4.2.47 TP47 – 3-V Rail Resistor Divider**4.2.48 TP49 – Floating Test Point****4.2.49 TP50 – Floating Test Point****4.2.50 TP51 – GND****4.2.51 TP52 - Floating Test Point****4.2.52 TP53 - Floating Test Point****4.2.53 TP54 – GND****4.2.54 TP55 – Floating Test Point****4.2.55 TP56 – Floating Test Point****4.2.56 TP57 – GND**

5 Schematic and Bill of Materials

This section includes the schematics and bill of materials for the EVM.

Figure 1 illustrates the schematics for this EVM.

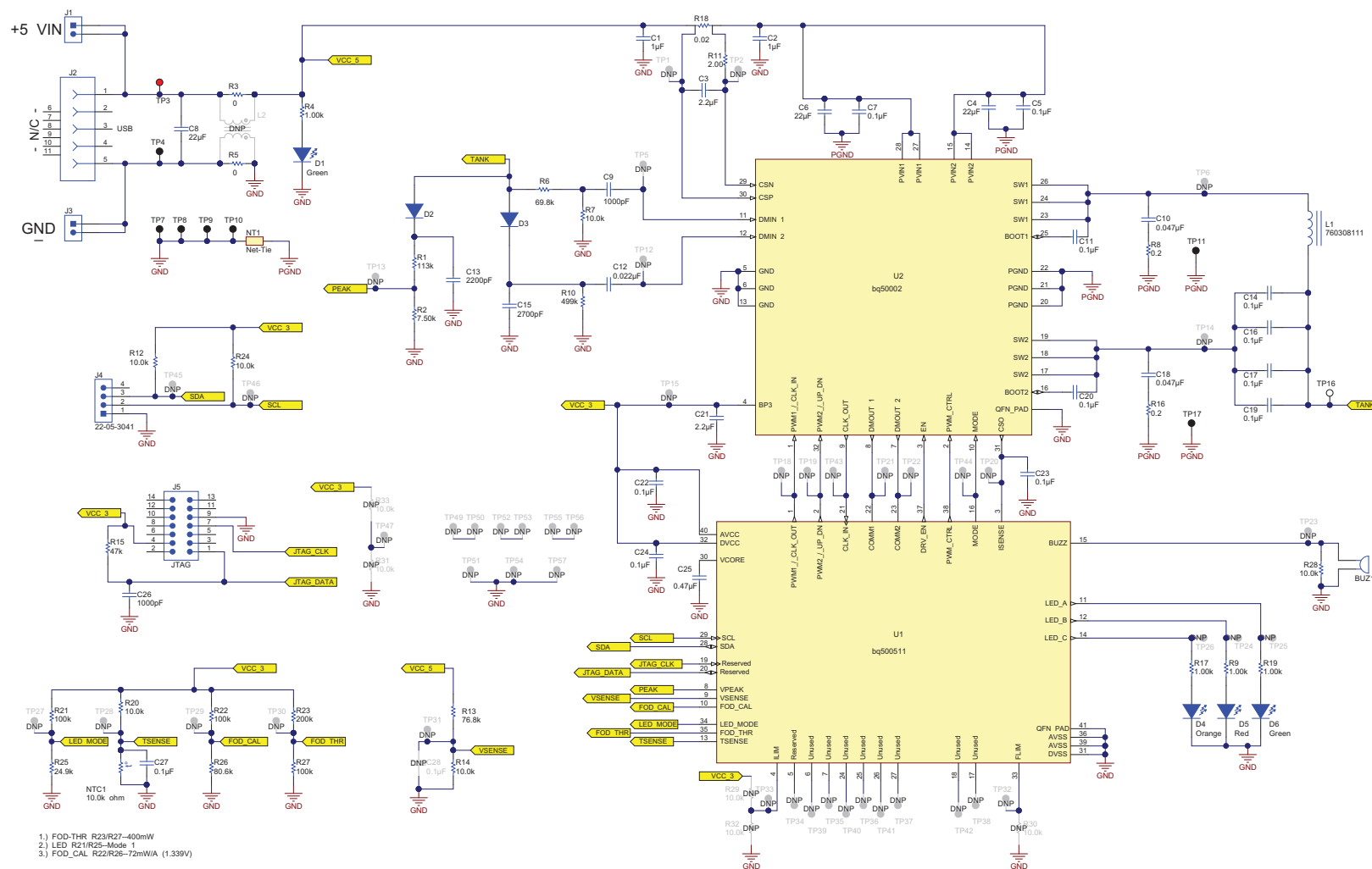

Figure 1. bq50002EVM-607 Schematic

Table 2 contains the BOM for this EVM.

Table 2. Bill of Materials⁽¹⁾

Designator	Qty	Value	Description	Package Reference	Part Number	Manufacturer	Alternate Part Number	Alternate Manufacturer
!PCB1	1		Printed Circuit Board		PWR607	Any	-	-
BUZ1	1		Buzzer, Piezo, 4kHz, 12.2mm, TH	12.2x4.0mm	PS1240P02CT3	TDK		
C1, C2	2	1uF	CAP, CERM, 1 µF, 25 V, +/- 10%, X7R, 0603	0603	GRM188R71E105KA12D	MuRata		
C3	1	2.2uF	CAP, CERM, 2.2 µF, 10 V, +/- 10%, X7R, 0603	0603	GRM188R71A225KE15D	MuRata		
C4, C6	2	22uF	CAP, CERM, 22uF, 25V, +/-20%, X5R, 0805	0805	GRM21BR61E226ME44	MuRata		
C5, C7, C11, C20, C22, C23, C24, C27	8	0.1uF	CAP, CERM, 0.1uF, 25V, +/-10%, X7R, 0603	0603	C1608X7R1E104K	TDK		
C8	1	22uF	CAP, CERM, 22uF, 25V, +/-10%, X7R, 1210	1210	GRM32ER71E226KE15L	MuRata		
C9, C26	2	1000pF	CAP, CERM, 1000pF, 50V, +/-5%, C0G/NP0, 0603	0603	C1608C0G1H102J	TDK		
C10, C18	2	0.047uF	CAP, CERM, 0.047uF, 50V, +/-10%, X7R, 0603	0603	C1608X7R1H473K	TDK		
C12	1	0.022uF	CAP, CERM, 0.022 µF, 50 V, +/- 10%, X7R, 0603	0603	C1608X7R1H223K	TDK		
C13	1	2200pF	CAP, CERM, 2200 pF, 50 V, +/- 10%, X7R, 0603	0603	GRM188R71H222KA01D	MuRata		
C14, C16, C17, C19	4	0.1uF	CAP, CERM, 0.1 µF, 25 V, +/- 5%, C0G/NP0, 1206	1206	C3216C0G1E104J	TDK		
C15	1	2700pF	CAP, CERM, 2700pF, 50V, +/-5%, C0G/NP0, 0603	0603	C1608C0G1H272J	TDK		
C21	1	2.2uF	CAP, CERM, 2.2uF, 16V, +/-10%, X5R, 0603	0603	GRM188R61C225KE15D	MuRata		
C25	1	0.47uF	CAP, CERM, 0.47uF, 10V, +/-10%, X7R, 0603	0603	GRM188R71A474KA61D	MuRata		
D1, D6	2	Green	LED, Green, SMD	1.6x0.8x0.8mm	LTST-C190KGKT	Lite-On		
D2, D3	2	100V	Diode, Switching, 100V, 0.2A, SOD-323	SOD-323	MMDL914-TP	Micro Commercial Components		
D4	1	Orange	LED, Orange, SMD	1.6x0.8x0.8mm	LTST-C190KFKT	Lite-On		
D5	1	Red	LED, Red, SMD	Red LED, 1.6x0.8x0.8mm	LTST-C190CKT	Lite-On		
H1	1		Cover, Plastic Polycarbonate, 2.75 " Square, 0.93 thick		MCH002	Any	-	-
H2, H5, H8, H11	4		Standoff, Nylon, Female to Male, 4-40 x 1/4"	4-40 x 1/4"	4800	Keystone	-	-
H3, H6, H9, H12, H17, H20	6		Mounting Feet, 0.25" tall		2563	Voltrex		
H4	1		Plate, aluminum 2.0"x2.0"x0.062"		MCH003	Any	-	-
H7	1		Sil-Pad Cut to Size 2.0" Square	See Assy Note ZZ5	GP1500-0.020-00-0816	Bergquist	GP1500-0.020-00-0404	Bergquist
H10	1		Adhesive, Thermally Conductive Silicone	See Assy Note ZZ6	SA-1000	Bergquist	-	-
H13, H15, H18, H21	4		Nut #4-40 Hex Nylon	4-40	NY HN 440	B&F Fastener Supply	-	-
H14, H16, H19, H22	4		Screw, steel zinc, flathead 4-40 machine, 0.250"	4-40 x 1/4"	Any	Any	-	-
J1, J3	2		Header, 100mil, 2x1, Tin, TH	Header, 2 PIN, 100mil, Tin	PEC02SAAN	Sullins Connector Solutions		
J2	1		Receptacle, Micro-USB-B, Right Angle, SMD	Micro USB receptacle	105017-0001	Molex		
J4	1		Header (friction lock), 100mil, 4x1, R/A, TH	4x1 R/A Header	22-05-3041	Molex		
J5	1		Header (shrouded), 100 mil, 7x2, Gold plated, TH	7x2 Shrouded Header	SBH11-PBPC-D07-ST-BK	Sullins Connector Solutions		
L1	1	6.3uH	Inductor, 6.3 µH, 13 A, 0.017 ohm, TH	TH, Dia 53mm, Pin spacing 14.2mm	760308111	Würth Elektronik		

⁽¹⁾ Unless otherwise noted in the Alternate Part Number and/or Alternate Manufacturer columns, all parts may be substituted with equivalents.

Table 2. Bill of Materials⁽¹⁾ (continued)

Designator	Qty	Value	Description	Package Reference	Part Number	Manufacturer	Alternate Part Number	Alternate Manufacturer
NTC1	1	10.0k ohm	Thermistor NTC, 10.0k ohm, 1%, 0603	0603	NTCG163JF103F	TDK		
R1	1	113k	RES, 113 k, 0.1%, 0.1 W, 0603	0603	RG1608P-1133-B-T5	Susumu Co Ltd		
R2	1	7.50k	RES, 7.50 k, 0.1%, 0.1 W, 0603	0603	RT0603BRD077K5L	Yageo America		
R3, R5	2	0	RES, 0 ohm, 5%, 0.25W, 1206	1206	CRCW12060000Z0EA	Vishay-Dale		
R4, R9, R17, R19	4	1.00k	RES, 1.00 k, 1%, 0.1 W, 0603	0603	CRCW06031K00FKEA	Vishay-Dale		
R6	1	69.8k	RES, 69.8k ohm, 1%, 0.1W, 0603	0603	RC0603FR-0769K8L	Yageo America		
R7, R12, R20, R24, R28	5	10.0k	RES, 10.0k ohm, 1%, 0.1W, 0603	0603	RC0603FR-0710KL	Yageo America		
R8, R16	2	0.2	RES, 0.2 ohm, 5%, 0.25W, 0805	0805	ERJ-S6SJR20V	Panasonic		
R10	1	499k	RES, 499k ohm, 1%, 0.1W, 0603	0603	RC0603FR-07499KL	Yageo America		
R11	1	2.00	RES, 2.00, 1%, 0.1 W, 0603	0603	CRCW06032R00FKEA	Vishay-Dale		
R13	1	76.8k	RES, 76.8 k, 0.1%, 0.1 W, 0603	0603	RG1608P-7682-B-T5	Susumu Co Ltd		
R14	1	10.0k	RES, 10.0 k, 0.1%, 0.1 W, 0603	0603	RT0603BRD0710KL	Yageo America		
R15	1	47k	RES, 47k ohm, 5%, 0.1W, 0603	0603	RC0603JR-0747KL	Yageo America		
R18	1	0.02	RES, 0.02, 0.5%, 0.5 W, 1206 sense	1206 sense	LVK12R020DER	Ohmite		
R21, R22, R27	3	100k	RES, 100 k, 1%, 0.1 W, 0603	0603	RC0603FR-07100KL	Yageo America		
R23	1	200k	RES, 200 k, 1%, 0.1 W, 0603	0603	RC0603FR-07200KL	Yageo America		
R25	1	24.9k	RES, 24.9 k, 1%, 0.1 W, 0603	0603	RC0603FR-0724K9L	Yageo America		
R26	1	80.6k	RES, 80.6 k, 1%, 0.1 W, 0603	0603	RC0603FR-0780K6L	Yageo America		
TP3	1	Red	Test Point, Compact, Red, TH	Red Compact Testpoint	5005	Keystone		
TP4, TP7, TP8, TP9, TP10, TP11, TP17	7	Black	Test Point, Multipurpose, Black, TH	Black Multipurpose Testpoint	5011	Keystone		
TP16	1	White	Test Point, Compact, White, TH	White Compact Testpoint	5007	Keystone		
U1	1		BQ500511RHA, RHA0040A	RHA0040A	bq500511	Texas Instruments	BQ500511RHAT	Texas Instruments
U2	1		4.2V to 5.5V Input, 3A Full Bridge, 2 Channel Analog Demodulation Wireless Power TX-Driver for Wireless Charging Applications, RHB0032E	RHB0032E	bq50002	Texas Instruments		None
C28	0	0.1uF	CAP, CERM, 0.1uF, 25V, +/-10%, X7R, 0603	0603	C1608X7R1E104K	TDK		
FID1, FID2, FID3	0		Fiducial mark. There is nothing to buy or mount.	Fiducial	N/A	N/A		
L2	0		Coupled inductor, 2.5 A, 0.034 ohm, SMD	SMD, 5x5mm	DLW5BTM102TQ2K	MuRata		
R29, R30, R31, R32, R33	0	10.0k	RES, 10.0k ohm, 1%, 0.1W, 0603	0603	RC0603FR-0710KL	Yageo America		
TP49, TP52, TP55	0	White	Test Point, Miniature, White, TH	White Miniature Testpoint	5002	Keystone		
TP51, TP54, TP57	0	Black	Test Point, Multipurpose, Black, TH	Black Multipurpose Testpoint	5011	Keystone		

6 Test Setup

6.1 Equipment

6.1.1 bqTESLA™ Receiver

Use the bq51013B-764 (HPA764) or bq51020EVM-520, a low-power Qi-compliant receiver.

6.1.2 Voltage Source

The input voltage source must provide a regulated DC voltage of 5 V and deliver at least 2.0-A continuous load current; current limit must be set to 2 A.

CAUTION

To help assure safety integrity of the system and minimize risk of electrical shock hazard, always use a power supply providing suitable isolation and supplemental insulation (double insulated). Compliance to IEC 61010-1, Safety Requirements for Electrical Equipment for Measurement, Control and Laboratory Use, Part 1, General Requirements, or its equivalent is strongly suggested, including any required regional regulatory compliance certification approvals. Always select a power source that is suitably rated for use with this EVM as referenced in this user manual.

External Power Supply Requirements:

Nom Voltage: 5.0 VDC

Max Current: 2.0 A

Efficiency Level V

External Power Supply Regulatory Compliance Certifications: Recommend selection and use of an external power supply which meets TI's required minimum electrical ratings in addition to complying with applicable regional product regulatory/safety certification requirements such as (by example) UL, CSA, VDE, CCC, PSE, and so forth.

6.1.3 Meters

Monitor the output voltage at the bq51013BEVM-764 test point TP7 with a voltmeter. Monitor the input current into the load with an appropriate ammeter. You can also monitor the transmitter input current and voltage, but the meter must use the averaging function for reducing error, due to communications packets.

6.1.4 Loads

A resistive load box that can be set to 10 k Ω , 10 Ω , and 5 Ω , power rating of at least 5 W; or an electronic load that can be set to 0 mA, 500 mA and 1.0 A at 5 V.

6.1.5 Oscilloscope

Use a dual-channel oscilloscope with appropriate probes to observe the RECT signal at bq51013BEVM-764 TP3 and other signals.

6.1.6 Recommended Wire Gauge

For proper operation, use 22-AWG wire when connecting the EVM to the input supply and the bq51013BEVM-764 to the load.

6.1.7 EV2400 Communication Kit

[EV2400-USB-Based PC Interface Kit.](#)

6.1.8 Software

[BQSTUDIO Battery Management Studio Software](#).

6.2 Equipment Setup

The following sections describe the steps for setting up the equipment.

6.2.1 PWR607 Input Supply

Set the input supply voltage to 5.0 V and current limit to 2.0 A before connecting to the UUT. Turn power supply off.

The input power supply positive lead is connected to J1. The power supply return lead is connected to J2 GND.

6.2.2 Oscilloscopes With Current Probe

Connect current probe to measure input current on positive power lead.

6.2.3 HPA764 Load

The load is connected between J3 OUT and J4 GND of the RX. Set the load resistance to 10-k Ω or 0 mA.

6.2.4 Jumper Settings

Unit Under Test, PWR607-No jumper installed.

bqTesla Receiver

- HPA764-JP1 → EN1 and LOW shorted
- HPA764-JP2 → EN2 and LOW shorted
- HPA764-JP3 → TS and DIS shorted
- HAP764-JP6 → ILIM and FIX shorted
- HPA764 → R3 set to 0, full CCW

6.2.5 Meters

Connect ammeter to measure UUT input current from power supply. Connect voltmeter to UUT and monitor input voltage at J1.

HPA764 connect voltmeter to monitor output voltage at TP7 and voltmeter to measure unregulated voltage at TP12. HPA764 connect current meter to monitor output current to load.

6.2.6 EV2400 Set Up

Connect J4 to EV2400 kit by 4-pin cable. Connect the USB port of the EV2400 kit to the USB port of the computer. The connections are shown in [Figure 2](#).

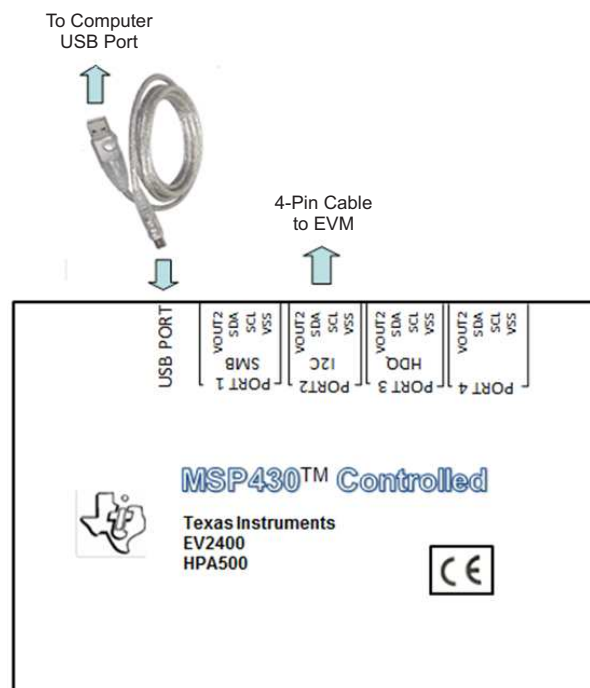

Figure 2. Connections of the EV2400 kit

6.2.7 Connector

A USB mini cable with red (+) and black (-) banana plugs and green/white wires shorted together. Note red lead will connect to pin 1 and black lead will connect to pin 5. Test cable should be 6- to 12-in long.

6.3 EVM Procedure

6.3.1 Set Input Voltage

Verify that the power supply is adjusted and connected according to [Section 6.1.2](#). Verify that the jumper settings are completed according to [Section 6.2.4](#).

6.3.2 bqStudio

Turn on the input power supply, verify the input voltage at J1 is 4.9 V to 5.1 V and the current is less than 100 mA. Turn on the computer and open the bq50002 evaluation software. Select “Charger” and click next. Select charger_1_00_bq50002.bqz and click finish. The main window of the software is shown in Figure 3.

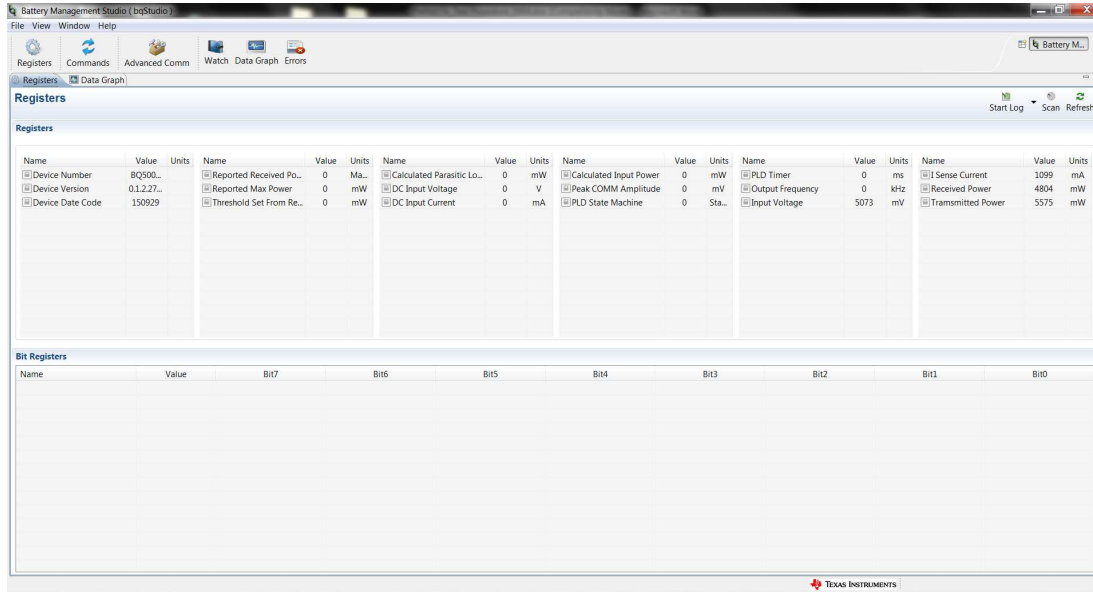

Figure 3. bqStudio Window

Place your mouse on the Device Version Value cell, the device version should be “0.1.2.2745”, as shown in Figure 3.

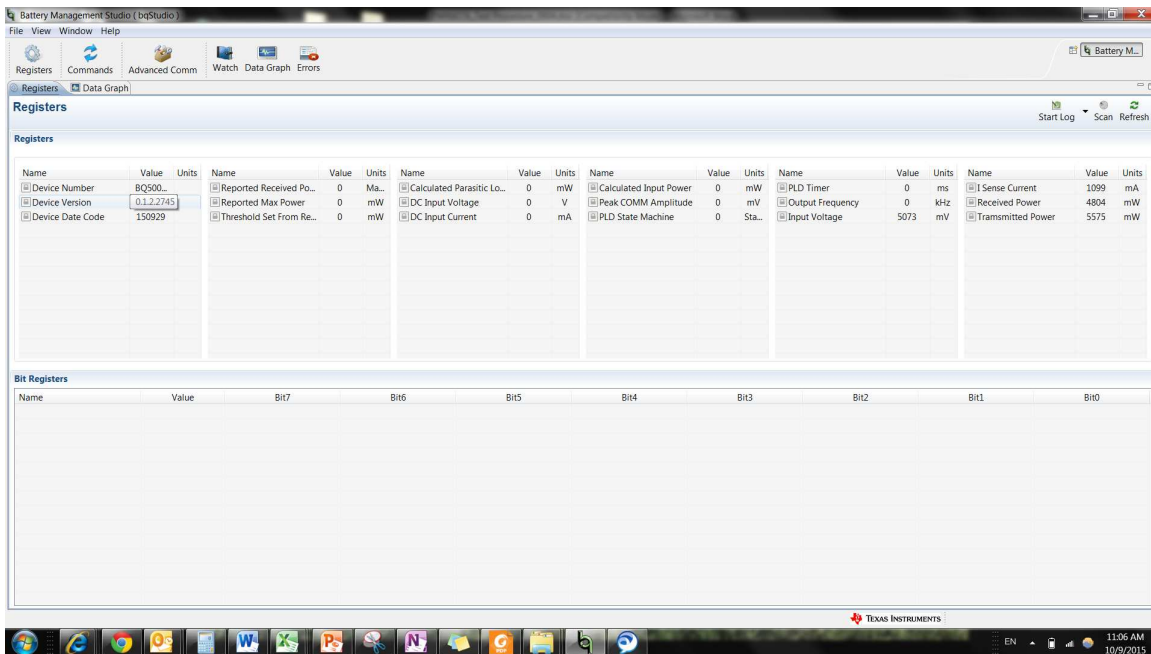

Figure 4. Device ID

Turn off power supply. And disconnect the EV2400 box from the EVM and the computer.

6.3.3 Start-Up No Receiver

Do not place any receiver on PWR607 for this test.

Turn on power supply and observe that:

1. Input voltage at J1 is 4.9 V to 5.1 V and current is less than 100 mA with a high-to-low fluctuation or toggling.
2. On UUT PWR607, Power On green LED D1 is ON
3. On UUT PWR607 LED D4, D5 and D6 are OFF
4. **Using current probe, monitor input current and observe digital pin will occur every 5 s for 70 ms.**

6.3.4 Receiver In Place – No Load

Place HPA764 on PWR607 above the TX Coil, load should be set to 10 k Ω or 0 mA.

Observe that:

1. On HPA764, LED D1 is ON
2. On HPA764, voltage at TP7 should be 4.9 V to 5.1 V
3. On HPA764, voltage at TP12 should be 7.0 V to 7.5 V, voltage will fluctuate.
4. On UUT PWR607 during power transfer (HPA764 D1 ON):
 - (a) LED D6, flashing Green
 - (b) Input current should be less than 300 mA

6.3.5 Receiver In Place – 1.0-A Load

With the HPA764 in place on the PWR607, above TX Coil set output load current to 950 mA to 1050 mA.

Input voltage at UUT J1 should be 4.9 V to 5.1 V, adjust input supply if necessary.

Observe that:

1. On HPA764 LED D1 is ON
2. On HPA764, voltage at TP7 should be 4.9 V to 5.1 V
3. On HPA764, voltage at TP12 should be 5.1 V to 5.3 V
4. On UUT, PWR607 LED D6 Flashing Green
5. On UUT, PWR607 input current should be less than 1700 mA

6.3.6 Efficiency

Measure the system efficiency by measuring the output voltage, output current, input voltage, and input current and calculate efficiency as the ratio of the output power to the input power. Connect voltage meters at the input and output of TX and RX. Average the input current; the comm pulses modulate the input current, distorting the reading. Figure 5 shows efficiency.

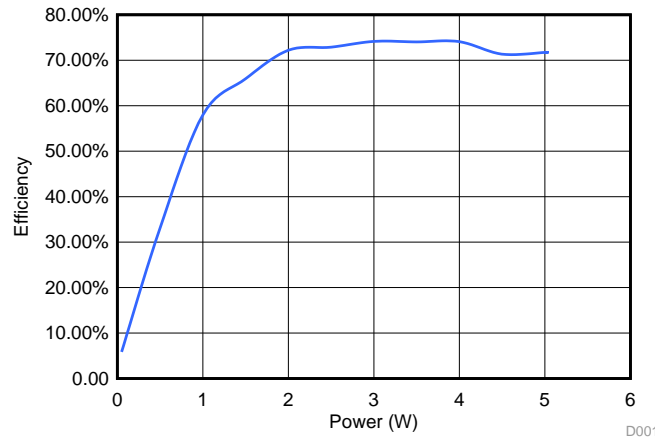

Figure 5. Efficiency vs Power, bq50002EVM-607 TX and bq51013BEVM-764 Receiver

6.3.7 Start Up Receiver Placed on Transmitter

The transmitter will send an analog ping about every 400 ms. If a receiver is present, it will power up and reply then begin power transfer. Figure 6 is a scope capture of the bq50002 EVM beginning a power transfer with the bq51013B EVM.

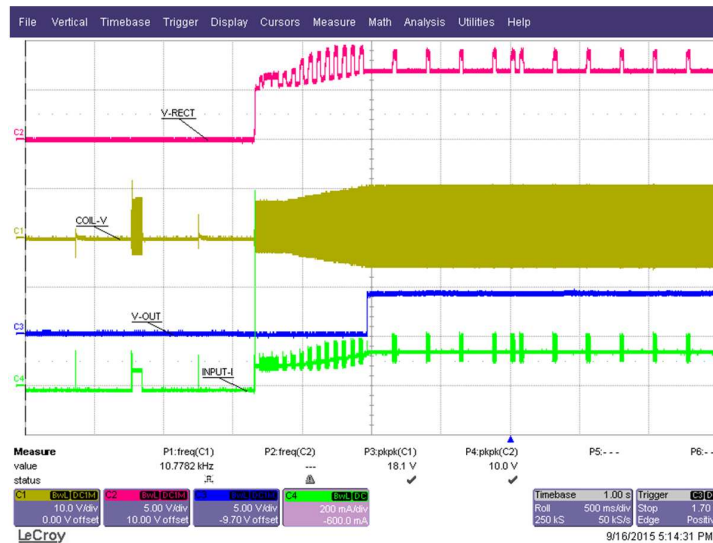

Figure 6. Start Up

6.3.8 TS Fault

With HPA764 and PWR607 operating in the configuration from Section 6.3.5, on the EVM HPA764, adjust R3 to 0 Ω. Next, move the TS Jumper JP3 from TS-DS to TS-EN. UUT PWR607 Red fault LED, D5 should light.

6.3.9 Foreign Object Detection (FOD)

The bq50002 EVM supports FOD in order to meet the requirements of the WPC V1.2 specification. Continuously monitoring input power, known losses, and the value of power reported by the receiver device being charged, the bq500511 can estimate how much power is unaccounted for and presumed lost due to metal objects placed in the wireless power transfer path. If this unexpected loss exceeds the threshold set by the FOD resistors, a fault is indicated and power transfer is halted.

Three key measurements for the TX FOD calculation:

- **Input Power** – Product of input voltage and current. Input voltage is measured at BQ500511 pin 9 through R13 and R14. Input current is measured using sense resistor R18 at BQ50002 pin 29 and 30. Both measurements must be very accurate.
- **Power Loss in Transmitter** – This is an internal calculation based on the operating point of the transmitter. The calculation is adjusted using FOD_CAL resistor, R26. This calculation changes with external component changes in the power path such as resonant capacitors and TX coil. Recalculation of R26 and R27 is required.
- **Receiver Reported Power** – The receiver calculates and reports power it receives in the message packet Received Power Packet.

The FOD threshold on the EVM is set to 400 mW when R27 is set to 100 k Ω . Increasing R27 increases the threshold and reduces the sensitivity to foreign objects. This loss threshold is determined after making a measurement of transmitter performance using a FOD calibration receiver similar to a unit manufactured by Avid® Technology. Contact Texas Instruments for the FOD calibration procedure for the bq50002.

6.3.10 Thermal Performance

This section shows a thermal image of the bq50002EVM-607. A 1000-mA load is used at the receiver output, bq51013BEVM-764. Output power is approximately 5 W, 1 A at 5 V. The highest temperature point in [Figure 7](#) is 35.6°C

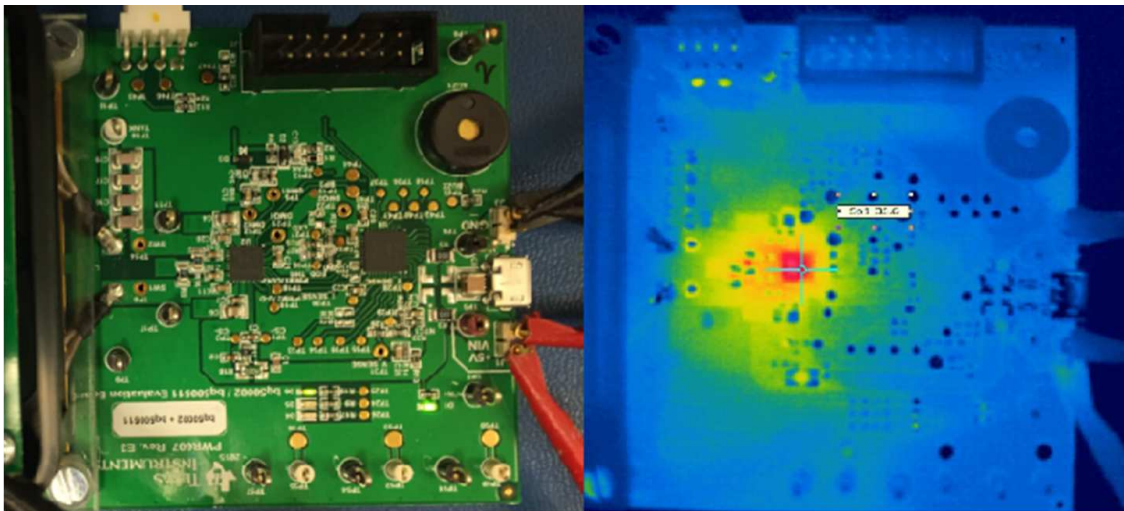

Figure 7. Thermal Performance

7 bq50002EVM-607 Assembly Drawings and Layout

Figure 8 through Figure 11 show the design of the bq50002EVM PCB. The EVM has been designed using a 4-layer, 2-oz, copper-clad circuit board, 13.2 cm x 7.24 cm with all components in a 4.0-cm x 5.0-cm active area on the top side and all active traces on the top and bottom layers to allow the user to easily view, probe, and evaluate bq50002 analog frontend IC and bq500511 control IC in a practical application. Moving components to both sides of the PCB or using additional internal layers offers additional size reduction for space-constrained systems. Gerber files are available for download from the EVM product folder ([bq50002EVM-607](#)).

A 4-layer PCB design is recommended to provide a good low-noise ground plane for all circuits. A 2-layer PCB presents a high risk of poor performance. Grounding between the bq50002 GND pins and filter capacitor returns should be a good low-impedance path.

Coil Grounding – A ground plane area under the coil is recommended to reduce noise coupling into the receiver. The ground plane for the EVM is slightly larger than the coil footprint and grounded at one point back to the circuit area.

Note: The clear plastic cover thickness (0.93 in or 2.4 mm) is the z-gap thickness for the transmitter.

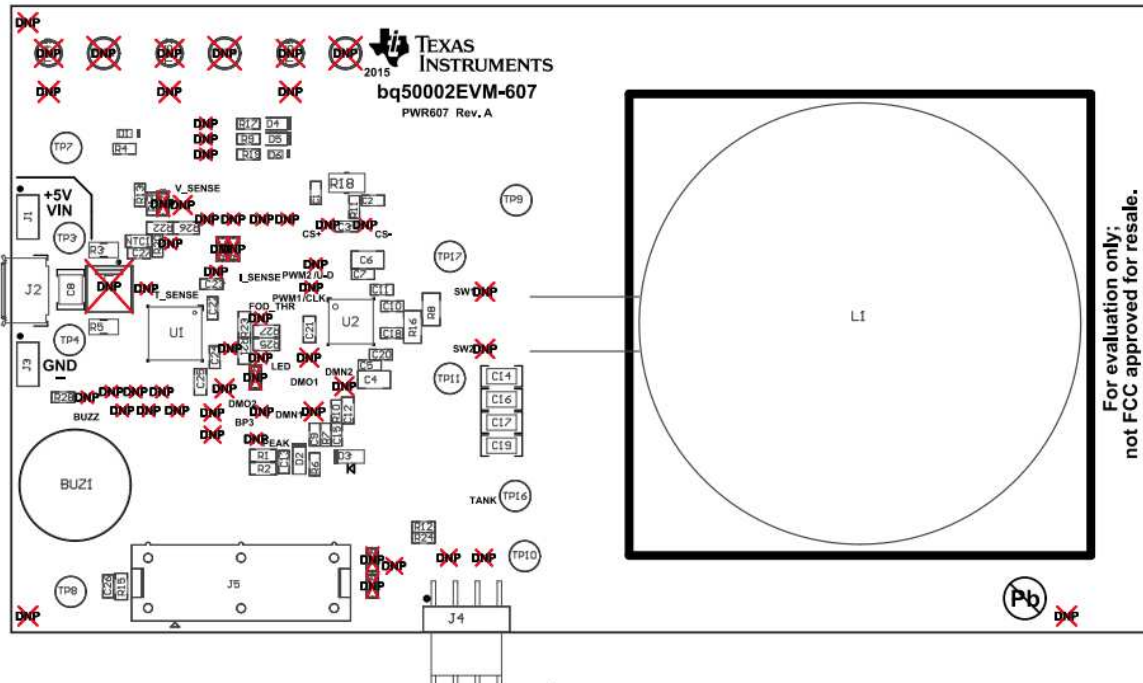

Figure 8. Assembly Top

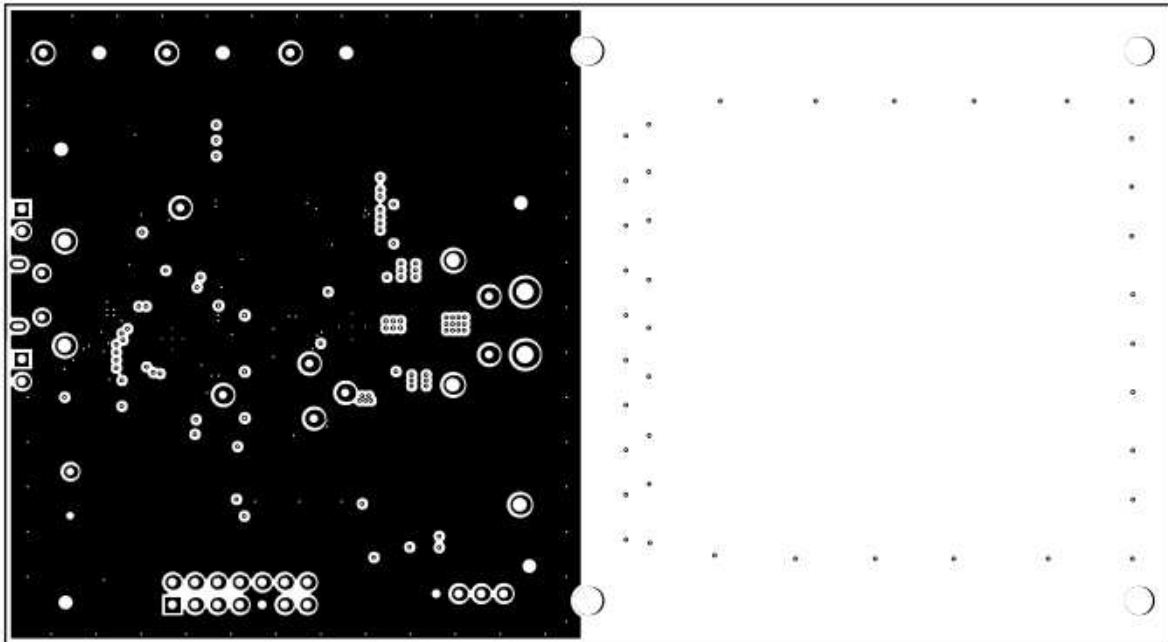

Figure 9. Inner Layer 1

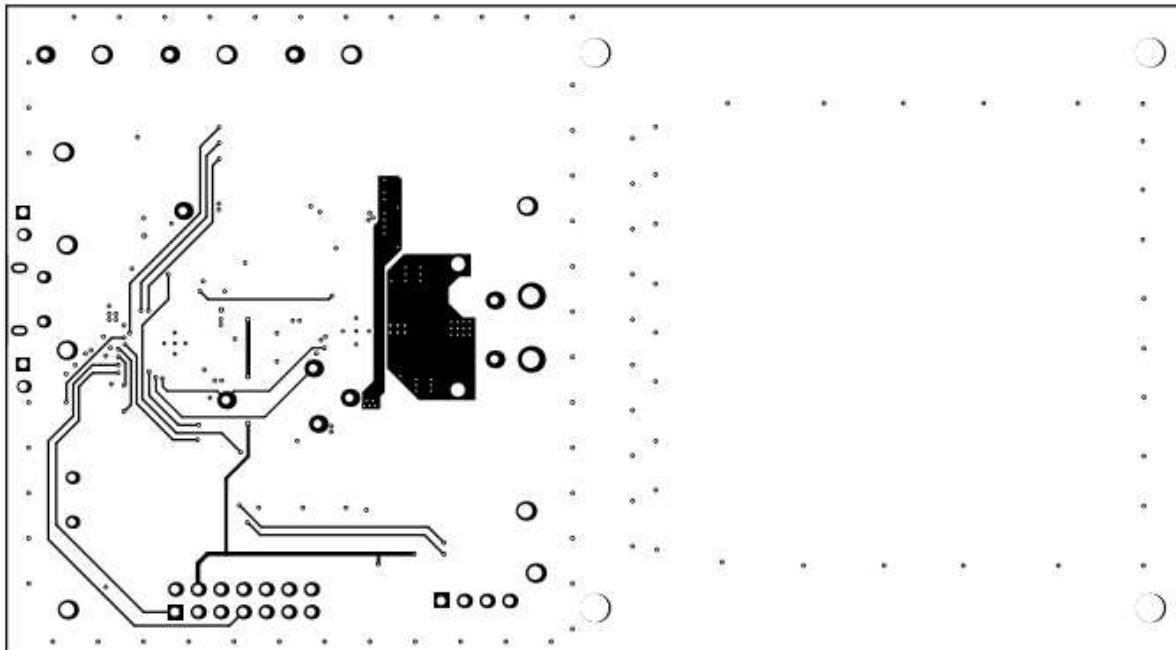

Figure 10. Inner Layer 2

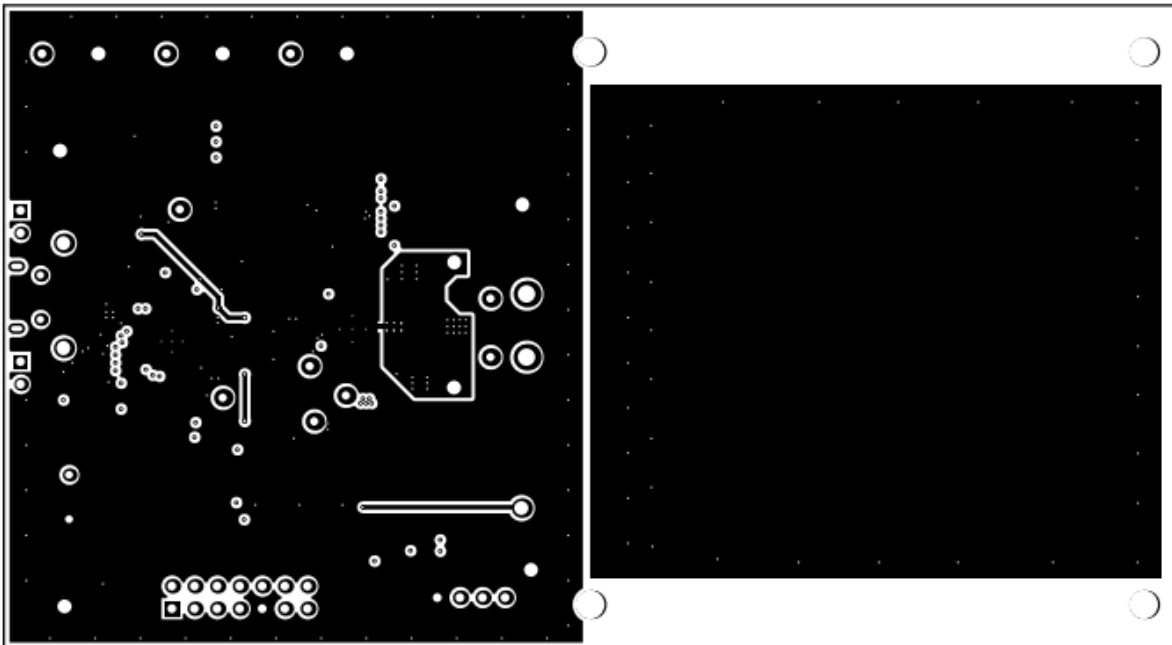

Figure 11. Bottom Layer

8 Reference

For additional information about the bq50002EVM-607 low-power, wireless, power evaluation kit from Texas Instruments, visit the product folder on the TI Web site at <http://www.ti.com/product/bq50002>

STANDARD TERMS AND CONDITIONS FOR EVALUATION MODULES

1. *Delivery:* TI delivers TI evaluation boards, kits, or modules, including any accompanying demonstration software, components, or documentation (collectively, an "EVM" or "EVMs") to the User ("User") in accordance with the terms and conditions set forth herein. Acceptance of the EVM is expressly subject to the following terms and conditions.
 - 1.1 EVMs are intended solely for product or software developers for use in a research and development setting to facilitate feasibility evaluation, experimentation, or scientific analysis of TI semiconductors products. EVMs have no direct function and are not finished products. EVMs shall not be directly or indirectly assembled as a part or subassembly in any finished product. For clarification, any software or software tools provided with the EVM ("Software") shall not be subject to the terms and conditions set forth herein but rather shall be subject to the applicable terms and conditions that accompany such Software
 - 1.2 EVMs are not intended for consumer or household use. EVMs may not be sold, sublicensed, leased, rented, loaned, assigned, or otherwise distributed for commercial purposes by Users, in whole or in part, or used in any finished product or production system.
2. *Limited Warranty and Related Remedies/Disclaimers:*
 - 2.1 These terms and conditions do not apply to Software. The warranty, if any, for Software is covered in the applicable Software License Agreement.
 - 2.2 TI warrants that the TI EVM will conform to TI's published specifications for ninety (90) days after the date TI delivers such EVM to User. Notwithstanding the foregoing, TI shall not be liable for any defects that are caused by neglect, misuse or mistreatment by an entity other than TI, including improper installation or testing, or for any EVMs that have been altered or modified in any way by an entity other than TI. Moreover, TI shall not be liable for any defects that result from User's design, specifications or instructions for such EVMs. Testing and other quality control techniques are used to the extent TI deems necessary or as mandated by government requirements. TI does not test all parameters of each EVM.
 - 2.3 If any EVM fails to conform to the warranty set forth above, TI's sole liability shall be at its option to repair or replace such EVM, or credit User's account for such EVM. TI's liability under this warranty shall be limited to EVMs that are returned during the warranty period to the address designated by TI and that are determined by TI not to conform to such warranty. If TI elects to repair or replace such EVM, TI shall have a reasonable time to repair such EVM or provide replacements. Repaired EVMs shall be warranted for the remainder of the original warranty period. Replaced EVMs shall be warranted for a new full ninety (90) day warranty period.
3. *Regulatory Notices:*
 - 3.1 *United States*
 - 3.1.1 *Notice applicable to EVMs not FCC-Approved:*

This kit is designed to allow product developers to evaluate electronic components, circuitry, or software associated with the kit to determine whether to incorporate such items in a finished product and software developers to write software applications for use with the end product. This kit is not a finished product and when assembled may not be resold or otherwise marketed unless all required FCC equipment authorizations are first obtained. Operation is subject to the condition that this product not cause harmful interference to licensed radio stations and that this product accept harmful interference. Unless the assembled kit is designed to operate under part 15, part 18 or part 95 of this chapter, the operator of the kit must operate under the authority of an FCC license holder or must secure an experimental authorization under part 5 of this chapter.
 - 3.1.2 *For EVMs annotated as FCC – FEDERAL COMMUNICATIONS COMMISSION Part 15 Compliant:*

CAUTION

This device complies with part 15 of the FCC Rules. Operation is subject to the following two conditions: (1) This device may not cause harmful interference, and (2) this device must accept any interference received, including interference that may cause undesired operation.

Changes or modifications not expressly approved by the party responsible for compliance could void the user's authority to operate the equipment.

FCC Interference Statement for Class A EVM devices

NOTE: This equipment has been tested and found to comply with the limits for a Class A digital device, pursuant to part 15 of the FCC Rules. These limits are designed to provide reasonable protection against harmful interference when the equipment is operated in a commercial environment. This equipment generates, uses, and can radiate radio frequency energy and, if not installed and used in accordance with the instruction manual, may cause harmful interference to radio communications. Operation of this equipment in a residential area is likely to cause harmful interference in which case the user will be required to correct the interference at his own expense.

FCC Interference Statement for Class B EVM devices

NOTE: This equipment has been tested and found to comply with the limits for a Class B digital device, pursuant to part 15 of the FCC Rules. These limits are designed to provide reasonable protection against harmful interference in a residential installation. This equipment generates, uses and can radiate radio frequency energy and, if not installed and used in accordance with the instructions, may cause harmful interference to radio communications. However, there is no guarantee that interference will not occur in a particular installation. If this equipment does cause harmful interference to radio or television reception, which can be determined by turning the equipment off and on, the user is encouraged to try to correct the interference by one or more of the following measures:

- Reorient or relocate the receiving antenna.
- Increase the separation between the equipment and receiver.
- Connect the equipment into an outlet on a circuit different from that to which the receiver is connected.
- Consult the dealer or an experienced radio/TV technician for help.

3.2 Canada

3.2.1 For EVMs issued with an Industry Canada Certificate of Conformance to RSS-210

Concerning EVMs Including Radio Transmitters:

This device complies with Industry Canada license-exempt RSS standard(s). Operation is subject to the following two conditions: (1) this device may not cause interference, and (2) this device must accept any interference, including interference that may cause undesired operation of the device.

Concernant les EVMs avec appareils radio:

Le présent appareil est conforme aux CNR d'Industrie Canada applicables aux appareils radio exempts de licence. L'exploitation est autorisée aux deux conditions suivantes: (1) l'appareil ne doit pas produire de brouillage, et (2) l'utilisateur de l'appareil doit accepter tout brouillage radioélectrique subi, même si le brouillage est susceptible d'en compromettre le fonctionnement.

Concerning EVMs Including Detachable Antennas:

Under Industry Canada regulations, this radio transmitter may only operate using an antenna of a type and maximum (or lesser) gain approved for the transmitter by Industry Canada. To reduce potential radio interference to other users, the antenna type and its gain should be so chosen that the equivalent isotropically radiated power (e.i.r.p.) is not more than that necessary for successful communication. This radio transmitter has been approved by Industry Canada to operate with the antenna types listed in the user guide with the maximum permissible gain and required antenna impedance for each antenna type indicated. Antenna types not included in this list, having a gain greater than the maximum gain indicated for that type, are strictly prohibited for use with this device.

Concernant les EVMs avec antennes détachables

Conformément à la réglementation d'Industrie Canada, le présent émetteur radio peut fonctionner avec une antenne d'un type et d'un gain maximal (ou inférieur) approuvé pour l'émetteur par Industrie Canada. Dans le but de réduire les risques de brouillage radioélectrique à l'intention des autres utilisateurs, il faut choisir le type d'antenne et son gain de sorte que la puissance isotrope rayonnée équivalente (p.i.r.e.) ne dépasse pas l'intensité nécessaire à l'établissement d'une communication satisfaisante. Le présent émetteur radio a été approuvé par Industrie Canada pour fonctionner avec les types d'antenne énumérés dans le manuel d'usage et ayant un gain admissible maximal et l'impédance requise pour chaque type d'antenne. Les types d'antenne non inclus dans cette liste, ou dont le gain est supérieur au gain maximal indiqué, sont strictement interdits pour l'exploitation de l'émetteur.

3.3 Japan

3.3.1 *Notice for EVMs delivered in Japan:* Please see http://www.tij.co.jp/lstds/ti_ja/general/eStore/notice_01.page 日本国内に輸入される評価用キット、ボードについては、次のところをご覧ください。
http://www.tij.co.jp/lstds/ti_ja/general/eStore/notice_01.page

3.3.2 *Notice for Users of EVMs Considered "Radio Frequency Products" in Japan:* EVMs entering Japan may not be certified by TI as conforming to Technical Regulations of Radio Law of Japan.

If User uses EVMs in Japan, not certified to Technical Regulations of Radio Law of Japan, User is required by Radio Law of Japan to follow the instructions below with respect to EVMs:

1. Use EVMs in a shielded room or any other test facility as defined in the notification #173 issued by Ministry of Internal Affairs and Communications on March 28, 2006, based on Sub-section 1.1 of Article 6 of the Ministry's Rule for Enforcement of Radio Law of Japan,
2. Use EVMs only after User obtains the license of Test Radio Station as provided in Radio Law of Japan with respect to EVMs, or
3. Use of EVMs only after User obtains the Technical Regulations Conformity Certification as provided in Radio Law of Japan with respect to EVMs. Also, do not transfer EVMs, unless User gives the same notice above to the transferee. Please note that if User does not follow the instructions above, User will be subject to penalties of Radio Law of Japan.

【無線電波を送信する製品の開発キットをお使いになる際の注意事項】 開発キットの中には技術基準適合証明を受けていないものがあります。技術適合証明を受けていないものご使用に際しては、電波法遵守のため、以下のいずれかの措置を取っていただく必要がありますのでご注意ください。

1. 電波法施行規則第6条第1項第1号に基づく平成18年3月28日総務省告示第173号で定められた電波暗室等の試験設備でご使用いただく。
2. 実験局の免許を取得後ご使用いただく。
3. 技術基準適合証明を取得後ご使用いただく。

なお、本製品は、上記の「ご使用にあたっての注意」を譲渡先、移転先に通知しない限り、譲渡、移転できないものとします。

上記を遵守頂けない場合は、電波法の罰則が適用される可能性があることをご留意ください。日本テキサス・インスツルメンツ株式会社
東京都新宿区西新宿 6 丁目 2 4 番 1 号
西新宿三井ビル

3.3.3 *Notice for EVMs for Power Line Communication:* Please see http://www.tij.co.jp/llds/ti_ja/general/eStore/notice_02.page
電力線搬送波通信についての開発キットをお使いになる際の注意事項については、次のところをご覧ください。http://www.tij.co.jp/llds/ti_ja/general/eStore/notice_02.page

4 *EVM Use Restrictions and Warnings:*

4.1 EVMS ARE NOT FOR USE IN FUNCTIONAL SAFETY AND/OR SAFETY CRITICAL EVALUATIONS, INCLUDING BUT NOT LIMITED TO EVALUATIONS OF LIFE SUPPORT APPLICATIONS.

4.2 User must read and apply the user guide and other available documentation provided by TI regarding the EVM prior to handling or using the EVM, including without limitation any warning or restriction notices. The notices contain important safety information related to, for example, temperatures and voltages.

4.3 *Safety-Related Warnings and Restrictions:*

4.3.1 User shall operate the EVM within TI's recommended specifications and environmental considerations stated in the user guide, other available documentation provided by TI, and any other applicable requirements and employ reasonable and customary safeguards. Exceeding the specified performance ratings and specifications (including but not limited to input and output voltage, current, power, and environmental ranges) for the EVM may cause personal injury or death, or property damage. If there are questions concerning performance ratings and specifications, User should contact a TI field representative prior to connecting interface electronics including input power and intended loads. Any loads applied outside of the specified output range may also result in unintended and/or inaccurate operation and/or possible permanent damage to the EVM and/or interface electronics. Please consult the EVM user guide prior to connecting any load to the EVM output. If there is uncertainty as to the load specification, please contact a TI field representative. During normal operation, even with the inputs and outputs kept within the specified allowable ranges, some circuit components may have elevated case temperatures. These components include but are not limited to linear regulators, switching transistors, pass transistors, current sense resistors, and heat sinks, which can be identified using the information in the associated documentation. When working with the EVM, please be aware that the EVM may become very warm.

4.3.2 EVMs are intended solely for use by technically qualified, professional electronics experts who are familiar with the dangers and application risks associated with handling electrical mechanical components, systems, and subsystems. User assumes all responsibility and liability for proper and safe handling and use of the EVM by User or its employees, affiliates, contractors or designees. User assumes all responsibility and liability to ensure that any interfaces (electronic and/or mechanical) between the EVM and any human body are designed with suitable isolation and means to safely limit accessible leakage currents to minimize the risk of electrical shock hazard. User assumes all responsibility and liability for any improper or unsafe handling or use of the EVM by User or its employees, affiliates, contractors or designees.

4.4 User assumes all responsibility and liability to determine whether the EVM is subject to any applicable international, federal, state, or local laws and regulations related to User's handling and use of the EVM and, if applicable, User assumes all responsibility and liability for compliance in all respects with such laws and regulations. User assumes all responsibility and liability for proper disposal and recycling of the EVM consistent with all applicable international, federal, state, and local requirements.

5. *Accuracy of Information:* To the extent TI provides information on the availability and function of EVMs, TI attempts to be as accurate as possible. However, TI does not warrant the accuracy of EVM descriptions, EVM availability or other information on its websites as accurate, complete, reliable, current, or error-free.

6. *Disclaimers:*
- 6.1 EXCEPT AS SET FORTH ABOVE, EVMS AND ANY WRITTEN DESIGN MATERIALS PROVIDED WITH THE EVM (AND THE DESIGN OF THE EVM ITSELF) ARE PROVIDED "AS IS" AND "WITH ALL FAULTS." TI DISCLAIMS ALL OTHER WARRANTIES, EXPRESS OR IMPLIED, REGARDING SUCH ITEMS, INCLUDING BUT NOT LIMITED TO ANY IMPLIED WARRANTIES OF MERCHANTABILITY OR FITNESS FOR A PARTICULAR PURPOSE OR NON-INFRINGEMENT OF ANY THIRD PARTY PATENTS, COPYRIGHTS, TRADE SECRETS OR OTHER INTELLECTUAL PROPERTY RIGHTS.
- 6.2 EXCEPT FOR THE LIMITED RIGHT TO USE THE EVM SET FORTH HEREIN, NOTHING IN THESE TERMS AND CONDITIONS SHALL BE CONSTRUED AS GRANTING OR CONFERRING ANY RIGHTS BY LICENSE, PATENT, OR ANY OTHER INDUSTRIAL OR INTELLECTUAL PROPERTY RIGHT OF TI, ITS SUPPLIERS/LICENSORS OR ANY OTHER THIRD PARTY, TO USE THE EVM IN ANY FINISHED END-USER OR READY-TO-USE FINAL PRODUCT, OR FOR ANY INVENTION, DISCOVERY OR IMPROVEMENT MADE, CONCEIVED OR ACQUIRED PRIOR TO OR AFTER DELIVERY OF THE EVM.
7. *USER'S INDEMNITY OBLIGATIONS AND REPRESENTATIONS.* USER WILL DEFEND, INDEMNIFY AND HOLD TI, ITS LICENSORS AND THEIR REPRESENTATIVES HARMLESS FROM AND AGAINST ANY AND ALL CLAIMS, DAMAGES, LOSSES, EXPENSES, COSTS AND LIABILITIES (COLLECTIVELY, "CLAIMS") ARISING OUT OF OR IN CONNECTION WITH ANY HANDLING OR USE OF THE EVM THAT IS NOT IN ACCORDANCE WITH THESE TERMS AND CONDITIONS. THIS OBLIGATION SHALL APPLY WHETHER CLAIMS ARISE UNDER STATUTE, REGULATION, OR THE LAW OF TORT, CONTRACT OR ANY OTHER LEGAL THEORY, AND EVEN IF THE EVM FAILS TO PERFORM AS DESCRIBED OR EXPECTED.
8. *Limitations on Damages and Liability:*
- 8.1 *General Limitations.* IN NO EVENT SHALL TI BE LIABLE FOR ANY SPECIAL, COLLATERAL, INDIRECT, PUNITIVE, INCIDENTAL, CONSEQUENTIAL, OR EXEMPLARY DAMAGES IN CONNECTION WITH OR ARISING OUT OF THESE TERMS AND CONDITIONS OR THE USE OF THE EVMS PROVIDED HEREUNDER, REGARDLESS OF WHETHER TI HAS BEEN ADVISED OF THE POSSIBILITY OF SUCH DAMAGES. EXCLUDED DAMAGES INCLUDE, BUT ARE NOT LIMITED TO, COST OF REMOVAL OR REINSTALLATION, ANCILLARY COSTS TO THE PROCUREMENT OF SUBSTITUTE GOODS OR SERVICES, RETESTING, OUTSIDE COMPUTER TIME, LABOR COSTS, LOSS OF GOODWILL, LOSS OF PROFITS, LOSS OF SAVINGS, LOSS OF USE, LOSS OF DATA, OR BUSINESS INTERRUPTION. NO CLAIM, SUIT OR ACTION SHALL BE BROUGHT AGAINST TI MORE THAN ONE YEAR AFTER THE RELATED CAUSE OF ACTION HAS OCCURRED.
- 8.2 *Specific Limitations.* IN NO EVENT SHALL TI'S AGGREGATE LIABILITY FROM ANY WARRANTY OR OTHER OBLIGATION ARISING OUT OF OR IN CONNECTION WITH THESE TERMS AND CONDITIONS, OR ANY USE OF ANY TI EVM PROVIDED HEREUNDER, EXCEED THE TOTAL AMOUNT PAID TO TI FOR THE PARTICULAR UNITS SOLD UNDER THESE TERMS AND CONDITIONS WITH RESPECT TO WHICH LOSSES OR DAMAGES ARE CLAIMED. THE EXISTENCE OF MORE THAN ONE CLAIM AGAINST THE PARTICULAR UNITS SOLD TO USER UNDER THESE TERMS AND CONDITIONS SHALL NOT ENLARGE OR EXTEND THIS LIMIT.
9. *Return Policy.* Except as otherwise provided, TI does not offer any refunds, returns, or exchanges. Furthermore, no return of EVM(s) will be accepted if the package has been opened and no return of the EVM(s) will be accepted if they are damaged or otherwise not in a resalable condition. If User feels it has been incorrectly charged for the EVM(s) it ordered or that delivery violates the applicable order, User should contact TI. All refunds will be made in full within thirty (30) working days from the return of the components(s), excluding any postage or packaging costs.
10. *Governing Law:* These terms and conditions shall be governed by and interpreted in accordance with the laws of the State of Texas, without reference to conflict-of-laws principles. User agrees that non-exclusive jurisdiction for any dispute arising out of or relating to these terms and conditions lies within courts located in the State of Texas and consents to venue in Dallas County, Texas. Notwithstanding the foregoing, any judgment may be enforced in any United States or foreign court, and TI may seek injunctive relief in any United States or foreign court.

Mailing Address: Texas Instruments, Post Office Box 655303, Dallas, Texas 75265
Copyright © 2015, Texas Instruments Incorporated

IMPORTANT NOTICE

Texas Instruments Incorporated and its subsidiaries (TI) reserve the right to make corrections, enhancements, improvements and other changes to its semiconductor products and services per JESD46, latest issue, and to discontinue any product or service per JESD48, latest issue. Buyers should obtain the latest relevant information before placing orders and should verify that such information is current and complete. All semiconductor products (also referred to herein as "components") are sold subject to TI's terms and conditions of sale supplied at the time of order acknowledgment.

TI warrants performance of its components to the specifications applicable at the time of sale, in accordance with the warranty in TI's terms and conditions of sale of semiconductor products. Testing and other quality control techniques are used to the extent TI deems necessary to support this warranty. Except where mandated by applicable law, testing of all parameters of each component is not necessarily performed.

TI assumes no liability for applications assistance or the design of Buyers' products. Buyers are responsible for their products and applications using TI components. To minimize the risks associated with Buyers' products and applications, Buyers should provide adequate design and operating safeguards.

TI does not warrant or represent that any license, either express or implied, is granted under any patent right, copyright, mask work right, or other intellectual property right relating to any combination, machine, or process in which TI components or services are used. Information published by TI regarding third-party products or services does not constitute a license to use such products or services or a warranty or endorsement thereof. Use of such information may require a license from a third party under the patents or other intellectual property of the third party, or a license from TI under the patents or other intellectual property of TI.

Reproduction of significant portions of TI information in TI data books or data sheets is permissible only if reproduction is without alteration and is accompanied by all associated warranties, conditions, limitations, and notices. TI is not responsible or liable for such altered documentation. Information of third parties may be subject to additional restrictions.

Resale of TI components or services with statements different from or beyond the parameters stated by TI for that component or service voids all express and any implied warranties for the associated TI component or service and is an unfair and deceptive business practice. TI is not responsible or liable for any such statements.

Buyer acknowledges and agrees that it is solely responsible for compliance with all legal, regulatory and safety-related requirements concerning its products, and any use of TI components in its applications, notwithstanding any applications-related information or support that may be provided by TI. Buyer represents and agrees that it has all the necessary expertise to create and implement safeguards which anticipate dangerous consequences of failures, monitor failures and their consequences, lessen the likelihood of failures that might cause harm and take appropriate remedial actions. Buyer will fully indemnify TI and its representatives against any damages arising out of the use of any TI components in safety-critical applications.

In some cases, TI components may be promoted specifically to facilitate safety-related applications. With such components, TI's goal is to help enable customers to design and create their own end-product solutions that meet applicable functional safety standards and requirements. Nonetheless, such components are subject to these terms.

No TI components are authorized for use in FDA Class III (or similar life-critical medical equipment) unless authorized officers of the parties have executed a special agreement specifically governing such use.

Only those TI components which TI has specifically designated as military grade or "enhanced plastic" are designed and intended for use in military/aerospace applications or environments. Buyer acknowledges and agrees that any military or aerospace use of TI components which have **not** been so designated is solely at the Buyer's risk, and that Buyer is solely responsible for compliance with all legal and regulatory requirements in connection with such use.

TI has specifically designated certain components as meeting ISO/TS16949 requirements, mainly for automotive use. In any case of use of non-designated products, TI will not be responsible for any failure to meet ISO/TS16949.

Products

Audio	www.ti.com/audio
Amplifiers	amplifier.ti.com
Data Converters	dataconverter.ti.com
DLP® Products	www.dlp.com
DSP	dsp.ti.com
Clocks and Timers	www.ti.com/clocks
Interface	interface.ti.com
Logic	logic.ti.com
Power Mgmt	power.ti.com
Microcontrollers	microcontroller.ti.com
RFID	www.ti-rfid.com
OMAP Applications Processors	www.ti.com/omap
Wireless Connectivity	www.ti.com/wirelessconnectivity

Applications

Automotive and Transportation	www.ti.com/automotive
Communications and Telecom	www.ti.com/communications
Computers and Peripherals	www.ti.com/computers
Consumer Electronics	www.ti.com/consumer-apps
Energy and Lighting	www.ti.com/energy
Industrial	www.ti.com/industrial
Medical	www.ti.com/medical
Security	www.ti.com/security
Space, Avionics and Defense	www.ti.com/space-avionics-defense
Video and Imaging	www.ti.com/video

TI E2E Community

e2e.ti.com