

EVM User's Guide: TPS631012/3

TPS631012/3 Evaluation Module



Description

The TPS631012/3 is a highly efficiency, single-inductor, internally compensated buck-boost converter in a 8-pin, 0.9-mm × 1.8-mm DSBGA package. The output voltage is programmable from 1.0V to 5.5V in 25mV steps via I2C. The EVM is based on TPS631012, in which the power-up value of the ENABLE bit is 0. The only difference between TPS631012 and TPS631013 is the ENABLE bit.

Features

- Output current 1.5 A ($V_{in} > 2.7\text{ V}$ to $V_{out} = 3.3\text{ V}$)
- Over 92% efficiency $V_{in}=3.6\text{ V}$ to $V_{out}=3.3\text{ V}$ $I_{out}=1\text{ A}$
- 8 μA operating quiescent current
- I2C configurable
- Fixed frequency operation (2.0 MHz)
- Auto PFM / Forced PWM mode selectable

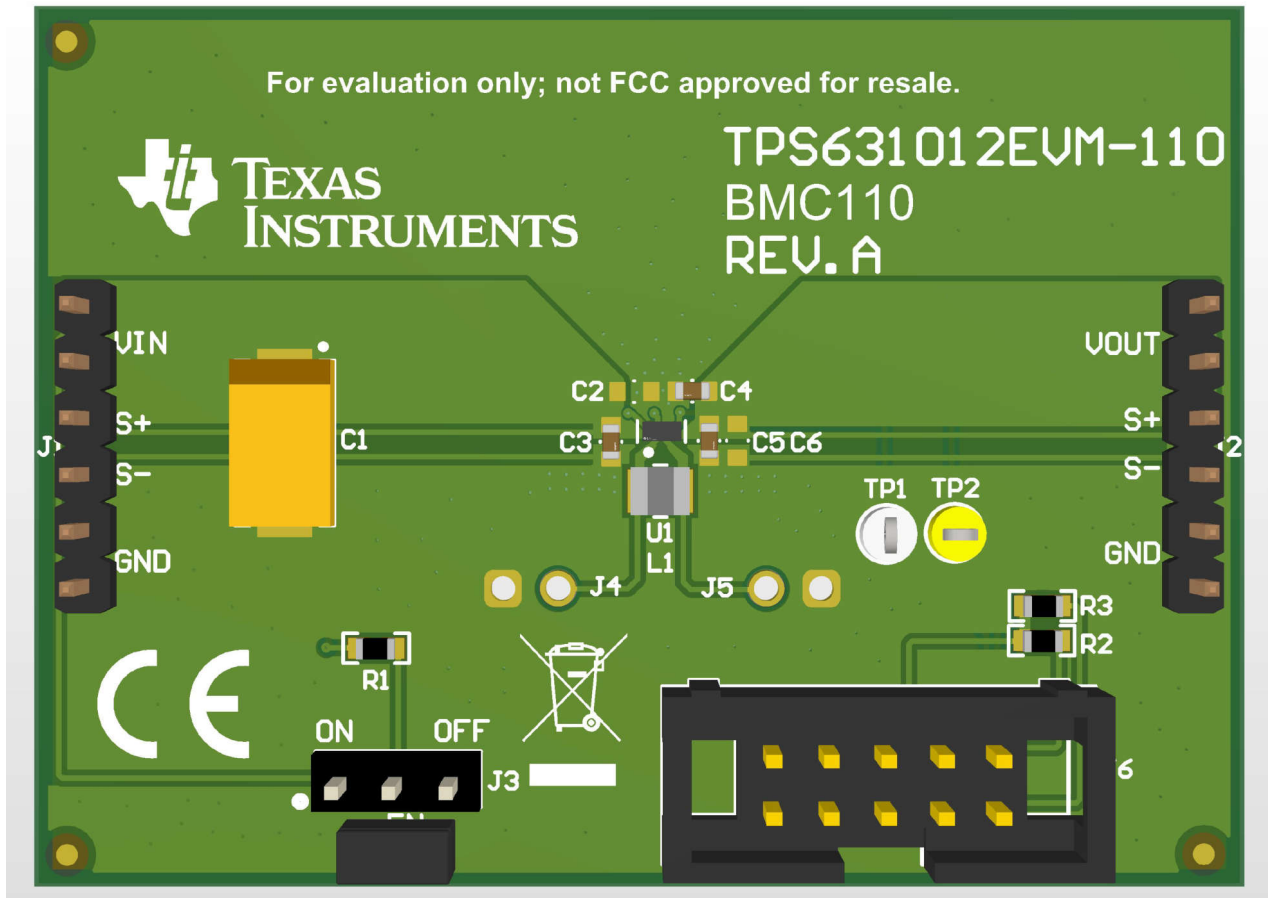

TPS631012/3 EVM

1 Evaluation Module Overview

1.1 Introduction

This user's guide describes the operation and use of the TPS631012/3EVM. The EVM is designed to help users easily evaluate and test the operation and functionality of the TPS631012/3 buck-boost converter family. The EVM has the output voltage set to 3.3 V. The output voltage can be programmed via I²C interface between 1.0 V and 5.5 V. The EVM operates with an input voltage between 1.6 V and 5.5 V and the output current can go up to 1.5 A when $V_{in} \geq 2.7V$. This document includes setup instructions for the hardware, together with the schematic and the PCB layout of the EVM. Throughout this document, the abbreviations EVM, TPS631012/3EVM, and the term evaluation module are synonymous with the TPS631012/3, unless otherwise noted.

1.2 Kit Contents

Table 1-1. Kit List

Designator	Quantity	Description	Material Type	Packaging
PCB1	1	TPS631012EVM; Circuit Board;	EEE	Bag, ESD
BOX1	1	Box, Cardboard	Cardboard	Box
FM1	2	Foam, Antistatic	Plastic	Foam
LBL1	1	Label, Small & Large standard labels	Paper/card stock	Paper
LIT1	1	Literature, EVM Disclaimer Read Me	Paper/card stock	Paper
LIT2	1	Literature, EVM Disclaimer Read Me	Paper/card stock	Paper

1.3 Specification

Table 1-2. Performance Specification Summary

SPECIFICATION	SPECIFICATION	MIN	TYP	MAX	UNIT
Input voltage		1.6		5.5	V
Start-up input voltage		1.65		5.5	V
Output voltage		1.0		5.5	V
Output current	$V_{in} \geq 2.7V, V_{out} = 3.3V$	0		1500	mA

1.4 Device Information

The TPS631012 and TPS631013 are constant frequency peak current mode control buck-boost converters in tiny wafer chip scale package. The TPS631012 and TPS631013 have a 3-A peak current limit (typical) and 1.6-V to 5.5-V input voltage range, and provide a power supply for system pre-regulators and voltage stabilizers.

2 Hardware

2.1 Background

The TPS631012/3EVM uses the TPS631012/3 integrated circuit (IC) , and is set to 3.3 V output voltage. The EVM operates with an input voltage between 1.6 V and 5.5 V.

2.2 Setup

This section describes how to properly use the TPS631012/3EVM.

2.3 Input and Output Connectors, Test Points, and Headers Description

2.3.1 J1, Pin 1 and 2 – VIN

Positive input voltage connection from the input power supply for the EVM.

2.3.2 J1, Pin 3 and 4 – S+/S-

Input voltage sense connections. Measure the input voltage at this point.

2.3.3 J1, Pin 5 and 6 – GND

Input voltage GND return connection from the input power supply for the EVM, common with J2 GND connection

2.3.4 J2, Pin 1 and 2 – VOUT

Positive output voltage connection

2.3.5 J2, Pin 3 and 4 – S+/S-

Output voltage sense connections. Measure the output voltage at this point.

2.3.6 J2, Pin 5 and 6 – GND

Output voltage GND return connection, common with J1 GND connection

2.3.7 Test Points

2.3.7.1 J4, J5

Test points connected to L1 and L2 switch node pins of the TPS631012/3

2.3.7.2 TP1, TP2

Test points connected to SDA and SCL pins of the TPS631012/3

2.3.8 Header Information

2.3.8.1 J6– I2C

10-pin header used to connect the USB2ANY adapter to the EVM

2.3.9 Jumper Information

2.3.9.1 JP1 – ENABLE

Placing a jumper across pins EN and ON enables the device. Placing a jumper across pins EN and OFF disables the device.

2.4 Setup

To operate the EVM, connect a power supply with the positive lead to J1 VIN pins and the negative lead to J1 GND pins. Connect a load with the positive lead to J2 VOUT pins and the negative lead to J2 GND pins. Place a jumper across EN and ON pins on J3 to enable the device.

2.5 Modifications

The printed-circuit board (PCB) for the EVM is designed to accommodate the TPS631012/3. Extra positions are available for additional input and output capacitors and I²C pullup resistors.

2.5.1 IC U1 Operation

This EVM requires an appropriate I²C interface, such as the TI USB2ANY, to reconfigure the TPS631012/3. The output voltage can be chosen between two I²C-programmable values by using an on-board jumper. See [Section 3.4](#) for the available output voltage values.

3 Software

3.1 Software Setup

A graphical user interface (GUI) is available from ti.com ([TPS631012](#)), which allows simple and convenient programming of the device through the TI USB2ANY (<http://www.ti.com/tool/USB2ANY>) device. Alternatively, the user can use any I²C-standardized programming tool or I²C host to configure the device. Be mindful of the I²C pins specification, such as timing parameters and proper pullup resistors.

3.2 Interface Hardware Setup

Connect the USB2ANY adapter to your PC using the supplied USB cable. Connect the EVM connector J3 to the USB2ANY adapter using the supplied 10-pin ribbon cable. The connectors on the ribbon cable are keyed to prevent incorrect installation.

[Figure 3-1](#) shows a quick adapter connection overview.

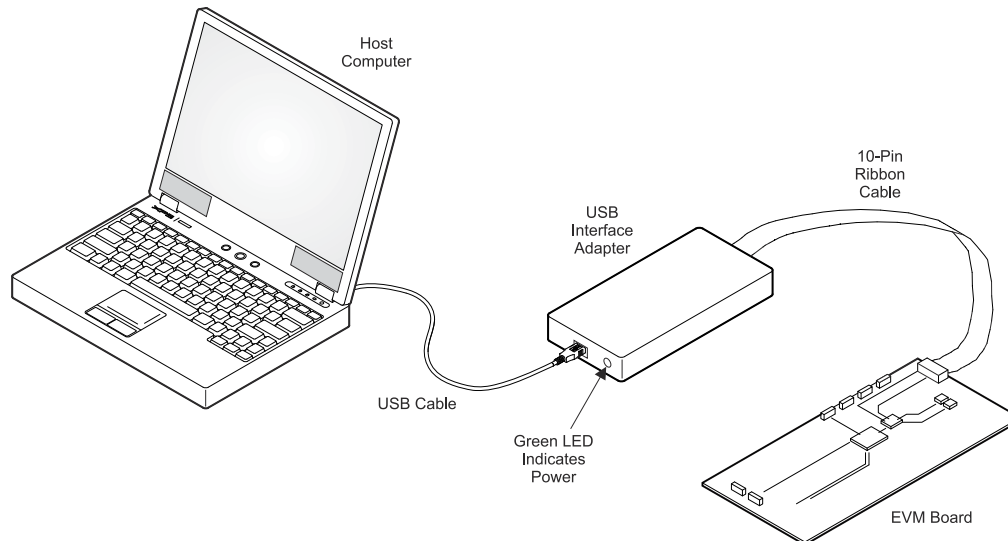

Figure 3-1. Quick Connection Overview

3.3 User Interface Operation

Upon start-up, the GUI automatically connects to the EVM. If not, then click on the *Connect* button in the lower left corner of the GUI window. The following sections give short overview of the three main GUI screens.

3.3.1 Home Screen

The Home screen gives a short overview of the TPS631012/3 devices. To start evaluating the device, click on the *Start* button or on the *Settings* or *Register Map* icons on the left side of the GUI window.

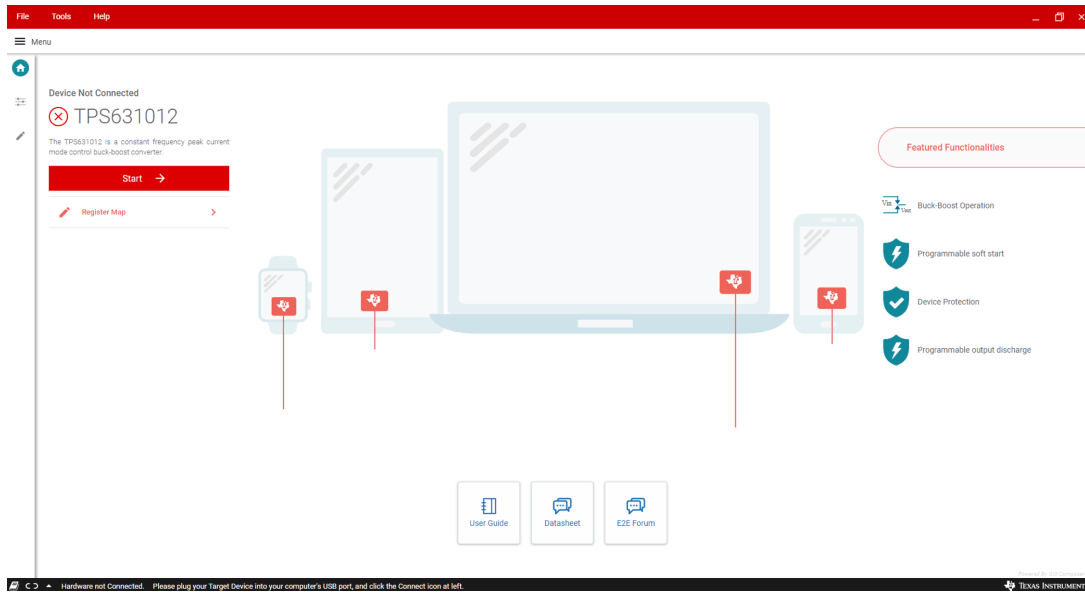

Figure 3-2. GUI Home Screen

3.3.2 Settings Screen

The *Settings* screen provides control over the output voltage and operating modes of the TPS631012/3.

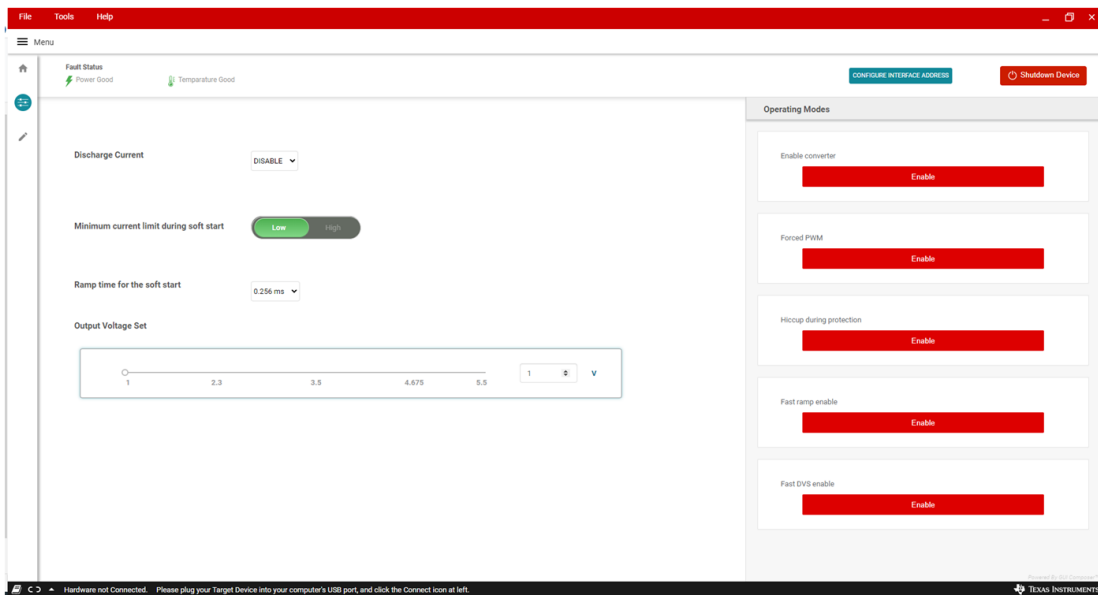

Figure 3-3. GUI Settings Screen

3.3.3 Register Map Screen

The Register Map screen shows a register-wise view of all parameters. Here, single registers can be read or written to the device (if applicable). Refer to [Section 3.4](#) for a detailed description of the TPS631012/3 registers.

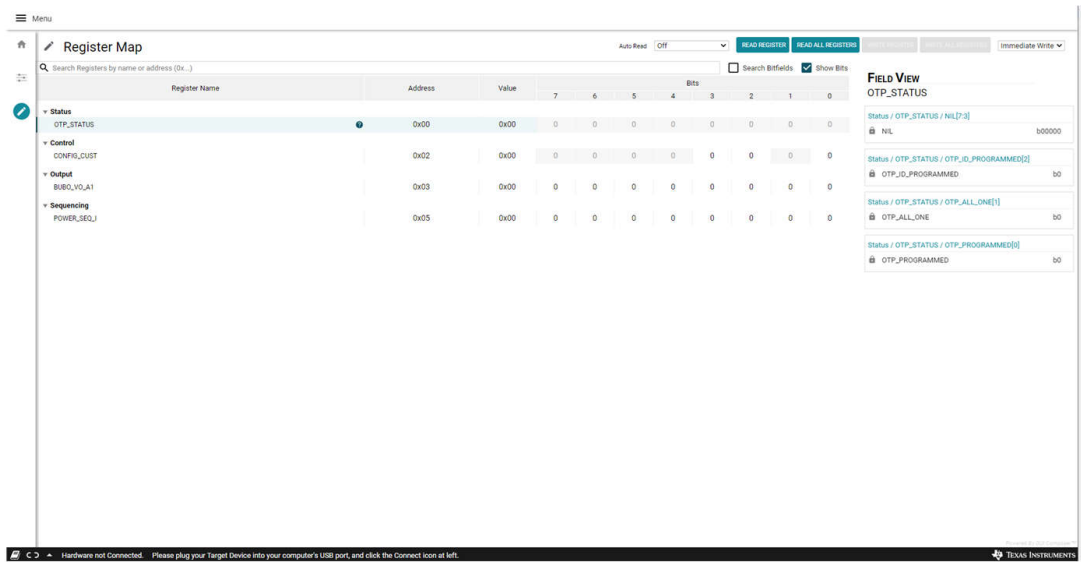

Figure 3-4. GUI Register Map Screen

3.4 Register Map

Table 3-1 lists the memory-mapped registers for the Device registers. All register offset addresses not listed in Table 3-1 must be considered as reserved locations and the register contents must not be modified.

Table 3-1. Device Registers

Address	Acronym	Register Name	Section
0X02	CONTROL1	Control 1 Register	Go
0X03	VOUT	VOUT Register	Go
0X05	CONTROL2	Control 2 Register	Go

3.4.1 Register CONTROL1 (Target Address: 0x2A; Register Address: 0x02; Default: 0x08)

Table 3-2 shows the CONTROL1 register.

Return to [Section 3.4](#).

This register configures the device. This register is volatile, so the register loses contents if the voltage on the VIN pin becomes less than the UVLO threshold or a low logic level is applied to the EN pin.

Table 3-2. CONTROL1 Register Field Descriptions

Bit	Field	Type	Reset	Description
7:4	RESERVED	R	0b0000	Not used. During write operations data for these bits are ignored. During read operations 0 is returned
3	EN_FAST_DVS	R/W	0b0	Sets DVS to fast mode 0 : DISABLE, 1 : ENABLE
2	EN_SCP	R/W	0b0	Enable short circuit hiccup protection 0 : DISABLE, 1 : ENABLE
1	NIL	R	0b0	Not used
0	CONVERTER_EN	R/W	0b0_TPS631012	Enable Converter ('AND'ed with EN-pin) 0 : DISABLE, 1 : ENABLE
			0b1_TPS631013	

3.4.2 Register VOUT (Target Address: 0x2A; Register Address: 0x03; Default: 0x5C)

Table 3-3 shows the STATUS register.

Return to [Section 3.4](#).

This register contains the device status. A read operation to this register clears the status bits. This register is volatile, so the register loses contents if the voltage on the VIN pin becomes less than the UVLO threshold or a low logic level is applied to the EN pin.

Table 3-3. Register VOUT Field Descriptions

Bit	Field	Type	Reset	Description
7:0	VOUT[7:0]	R/W	0X5C	These bits set the output voltage Output voltage = 1.000 + (VOUT[7 :0] × 0.025) V when 0x00<=VOUT[7 :0]<=0xB4; Output voltage = 5.5 V when 0xB5<=VOUT[7 :0]<=0xFF

3.4.3 Register CONTROL2 (Target Address: 0x2A; Register Address: 0x05; Default:0x45)

Table 3-4 shows the CONTROL2 register.

Return to [Section 3.4](#).

This register identifies the die revision of the device.

Table 3-4. Register CONTROL2 Field Descriptions

Bit	Field	Type	Reset	Description
7	FPWM	R/W	0b0	Force PWM operation 0 : DISABLE, 1 : ENABLE
6	FAST_RAMP_EN	R/W	0b1	Device can start-up faster then VOUT ramp 0 : DISABLE, 1 : ENABLE
5:4	EN_DISCH_VOUT[1:0]	R/W	0b00	Enable of BUBO Vout Discharge 00 : DISABLE 01 : SLOW (34mA) 10 : MEDIUM (67mA) 11 : FAST (100mA)
3	CL_RAMP_MIN	R/W	0b0	Define the minimum current limit during the soft start ramp 0 : Low (500mA) 1 : High (2x Low)
2:0	TD_RAMP[2:0]	R/W	0b101	Defines the ramp time for the Vo soft start ramp 000: 0.256ms 001: 0.512ms 010: 1.024ms 011: 1.920ms 100: 3.584ms 101: 7.552ms 110: 9.600ms 111: 24.320ms

4 Hardware Design Files

4.1 Schematic

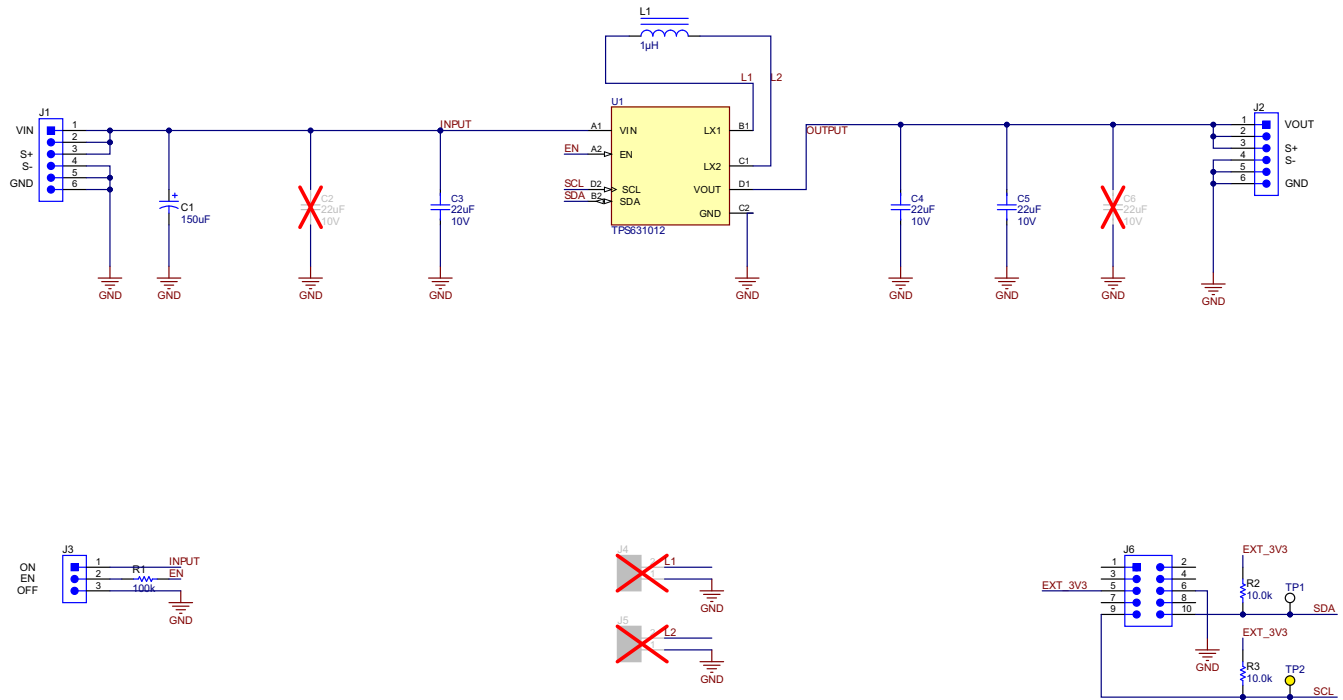

Figure 4-1. TPS631012/3EVM Schematic

4.2 Board Layout

This section provides the TPS631012/3EVM board layout and illustrations.

Figure 4-2 and Figure 4-3 show the component placement and PCB layout of the TPS631012/3EVM.

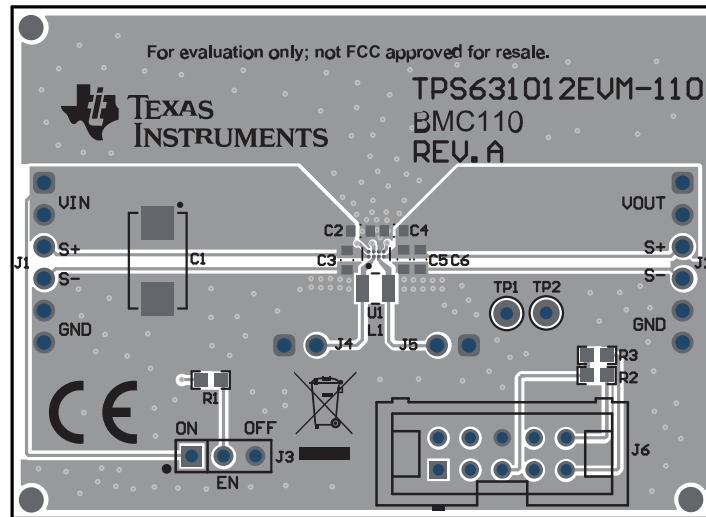

Figure 4-2. TPS631012/3EVM PCB - Top Layer

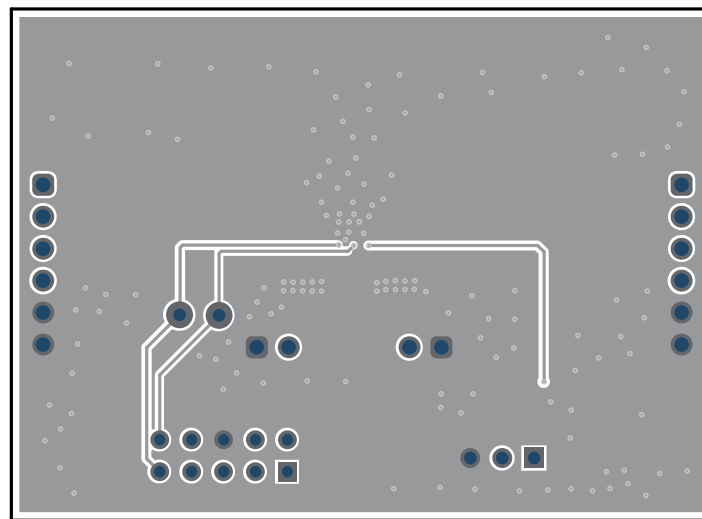

Figure 4-3. TPS631012/3EVM PCB - Bottom Layer (Top View)

4.3 Bill of Materials

Table 4-1. TPS631012/3EVM Bill of Materials

DESIGNATOR	QTY	VALUE	DESCRIPTION	SIZE	PART NUMBER	MANUFACTURER
C1	1	150uF	CAP, Tantalum Polymer, 150 uF, 10 V, +/- 20%, 0.005 ohm, 7343-31 SMD	7343-31	T530D157M010ATE005	Kemet
C3, C4, C5	3	22 µF	Multi-Layer Ceramic Capacitor 22 uF 10 V X5R ±20% 0603 Paper T/R	603	GRT188R61A226ME13D	Murata
L1	1	1uH	Inductor, Shielded, Metal Composite, 1 µH, 3.2 A, 0.042 ohm, SMD	1008	DFE252012P-1R0M=P2	MuRata
R1	1	100k	RES, 100 k, 5%, 0.1 W, 0603	603	CRCW0603100KJNEAC	Vishay-Dale
R2, R3	2	10.0k	RES, 10.0 k, 1%, 0.1 W, 0603	603	RC0603FR-0710KL	Yageo
U1	1	N/A	1.5-A Output Current, High Power Density Buck-Boost Converter With I2C Interface	WCSP8	TPS631012	Texas Instruments

5 Additional Information

5.1 Trademarks

All trademarks are the property of their respective owners.

STANDARD TERMS FOR EVALUATION MODULES

1. *Delivery:* TI delivers TI evaluation boards, kits, or modules, including any accompanying demonstration software, components, and/or documentation which may be provided together or separately (collectively, an "EVM" or "EVMs") to the User ("User") in accordance with the terms set forth herein. User's acceptance of the EVM is expressly subject to the following terms.
 - 1.1 EVMs are intended solely for product or software developers for use in a research and development setting to facilitate feasibility evaluation, experimentation, or scientific analysis of TI semiconductor products. EVMs have no direct function and are not finished products. EVMs shall not be directly or indirectly assembled as a part or subassembly in any finished product. For clarification, any software or software tools provided with the EVM ("Software") shall not be subject to the terms and conditions set forth herein but rather shall be subject to the applicable terms that accompany such Software
 - 1.2 EVMs are not intended for consumer or household use. EVMs may not be sold, sublicensed, leased, rented, loaned, assigned, or otherwise distributed for commercial purposes by Users, in whole or in part, or used in any finished product or production system.
2. *Limited Warranty and Related Remedies/Disclaimers:*
 - 2.1 These terms do not apply to Software. The warranty, if any, for Software is covered in the applicable Software License Agreement.
 - 2.2 TI warrants that the TI EVM will conform to TI's published specifications for ninety (90) days after the date TI delivers such EVM to User. Notwithstanding the foregoing, TI shall not be liable for a nonconforming EVM if (a) the nonconformity was caused by neglect, misuse or mistreatment by an entity other than TI, including improper installation or testing, or for any EVMs that have been altered or modified in any way by an entity other than TI, (b) the nonconformity resulted from User's design, specifications or instructions for such EVMs or improper system design, or (c) User has not paid on time. Testing and other quality control techniques are used to the extent TI deems necessary. TI does not test all parameters of each EVM. User's claims against TI under this Section 2 are void if User fails to notify TI of any apparent defects in the EVMs within ten (10) business days after delivery, or of any hidden defects with ten (10) business days after the defect has been detected.
 - 2.3 TI's sole liability shall be at its option to repair or replace EVMs that fail to conform to the warranty set forth above, or credit User's account for such EVM. TI's liability under this warranty shall be limited to EVMs that are returned during the warranty period to the address designated by TI and that are determined by TI not to conform to such warranty. If TI elects to repair or replace such EVM, TI shall have a reasonable time to repair such EVM or provide replacements. Repaired EVMs shall be warranted for the remainder of the original warranty period. Replaced EVMs shall be warranted for a new full ninety (90) day warranty period.

WARNING

Evaluation Kits are intended solely for use by technically qualified, professional electronics experts who are familiar with the dangers and application risks associated with handling electrical mechanical components, systems, and subsystems.

User shall operate the Evaluation Kit within TI's recommended guidelines and any applicable legal or environmental requirements as well as reasonable and customary safeguards. Failure to set up and/or operate the Evaluation Kit within TI's recommended guidelines may result in personal injury or death or property damage. Proper set up entails following TI's instructions for electrical ratings of interface circuits such as input, output and electrical loads.

NOTE:

EXPOSURE TO ELECTROSTATIC DISCHARGE (ESD) MAY CAUSE DEGRADATION OR FAILURE OF THE EVALUATION KIT; TI RECOMMENDS STORAGE OF THE EVALUATION KIT IN A PROTECTIVE ESD BAG.

3 Regulatory Notices:

3.1 United States

3.1.1 Notice applicable to EVMs not FCC-Approved:

FCC NOTICE: This kit is designed to allow product developers to evaluate electronic components, circuitry, or software associated with the kit to determine whether to incorporate such items in a finished product and software developers to write software applications for use with the end product. This kit is not a finished product and when assembled may not be resold or otherwise marketed unless all required FCC equipment authorizations are first obtained. Operation is subject to the condition that this product not cause harmful interference to licensed radio stations and that this product accept harmful interference. Unless the assembled kit is designed to operate under part 15, part 18 or part 95 of this chapter, the operator of the kit must operate under the authority of an FCC license holder or must secure an experimental authorization under part 5 of this chapter.

3.1.2 For EVMs annotated as FCC – FEDERAL COMMUNICATIONS COMMISSION Part 15 Compliant:

CAUTION

This device complies with part 15 of the FCC Rules. Operation is subject to the following two conditions: (1) This device may not cause harmful interference, and (2) this device must accept any interference received, including interference that may cause undesired operation.

Changes or modifications not expressly approved by the party responsible for compliance could void the user's authority to operate the equipment.

FCC Interference Statement for Class A EVM devices

NOTE: This equipment has been tested and found to comply with the limits for a Class A digital device, pursuant to part 15 of the FCC Rules. These limits are designed to provide reasonable protection against harmful interference when the equipment is operated in a commercial environment. This equipment generates, uses, and can radiate radio frequency energy and, if not installed and used in accordance with the instruction manual, may cause harmful interference to radio communications. Operation of this equipment in a residential area is likely to cause harmful interference in which case the user will be required to correct the interference at his own expense.

FCC Interference Statement for Class B EVM devices

NOTE: This equipment has been tested and found to comply with the limits for a Class B digital device, pursuant to part 15 of the FCC Rules. These limits are designed to provide reasonable protection against harmful interference in a residential installation. This equipment generates, uses and can radiate radio frequency energy and, if not installed and used in accordance with the instructions, may cause harmful interference to radio communications. However, there is no guarantee that interference will not occur in a particular installation. If this equipment does cause harmful interference to radio or television reception, which can be determined by turning the equipment off and on, the user is encouraged to try to correct the interference by one or more of the following measures:

- Reorient or relocate the receiving antenna.
- Increase the separation between the equipment and receiver.
- Connect the equipment into an outlet on a circuit different from that to which the receiver is connected.
- Consult the dealer or an experienced radio/TV technician for help.

3.2 Canada

3.2.1 For EVMs issued with an Industry Canada Certificate of Conformance to RSS-210 or RSS-247

Concerning EVMs Including Radio Transmitters:

This device complies with Industry Canada license-exempt RSSs. Operation is subject to the following two conditions:

(1) this device may not cause interference, and (2) this device must accept any interference, including interference that may cause undesired operation of the device.

Concernant les EVMs avec appareils radio:

Le présent appareil est conforme aux CNR d'Industrie Canada applicables aux appareils radio exempts de licence. L'exploitation est autorisée aux deux conditions suivantes: (1) l'appareil ne doit pas produire de brouillage, et (2) l'utilisateur de l'appareil doit accepter tout brouillage radioélectrique subi, même si le brouillage est susceptible d'en compromettre le fonctionnement.

Concerning EVMs Including Detachable Antennas:

Under Industry Canada regulations, this radio transmitter may only operate using an antenna of a type and maximum (or lesser) gain approved for the transmitter by Industry Canada. To reduce potential radio interference to other users, the antenna type and its gain should be so chosen that the equivalent isotropically radiated power (e.i.r.p.) is not more than that necessary for successful communication. This radio transmitter has been approved by Industry Canada to operate with the antenna types listed in the user guide with the maximum permissible gain and required antenna impedance for each antenna type indicated. Antenna types not included in this list, having a gain greater than the maximum gain indicated for that type, are strictly prohibited for use with this device.

Concernant les EVMs avec antennes détachables

Conformément à la réglementation d'Industrie Canada, le présent émetteur radio peut fonctionner avec une antenne d'un type et d'un gain maximal (ou inférieur) approuvé pour l'émetteur par Industrie Canada. Dans le but de réduire les risques de brouillage radioélectrique à l'intention des autres utilisateurs, il faut choisir le type d'antenne et son gain de sorte que la puissance isotrope rayonnée équivalente (p.i.r.e.) ne dépasse pas l'intensité nécessaire à l'établissement d'une communication satisfaisante. Le présent émetteur radio a été approuvé par Industrie Canada pour fonctionner avec les types d'antenne énumérés dans le manuel d'usage et ayant un gain admissible maximal et l'impédance requise pour chaque type d'antenne. Les types d'antenne non inclus dans cette liste, ou dont le gain est supérieur au gain maximal indiqué, sont strictement interdits pour l'exploitation de l'émetteur.

3.3 Japan

3.3.1 *Notice for EVMs delivered in Japan:* Please see http://www.tij.co.jp/lstds/ti_ja/general/eStore/notice_01.page 日本国内に輸入される評価用キット、ボードについては、次のところをご覧ください。

<https://www.ti.com/ja-jp/legal/notice-for-evaluation-kits-delivered-in-japan.html>

3.3.2 *Notice for Users of EVMs Considered "Radio Frequency Products" in Japan:* EVMs entering Japan may not be certified by TI as conforming to Technical Regulations of Radio Law of Japan.

If User uses EVMs in Japan, not certified to Technical Regulations of Radio Law of Japan, User is required to follow the instructions set forth by Radio Law of Japan, which includes, but is not limited to, the instructions below with respect to EVMs (which for the avoidance of doubt are stated strictly for convenience and should be verified by User):

1. Use EVMs in a shielded room or any other test facility as defined in the notification #173 issued by Ministry of Internal Affairs and Communications on March 28, 2006, based on Sub-section 1.1 of Article 6 of the Ministry's Rule for Enforcement of Radio Law of Japan,
2. Use EVMs only after User obtains the license of Test Radio Station as provided in Radio Law of Japan with respect to EVMs, or
3. Use of EVMs only after User obtains the Technical Regulations Conformity Certification as provided in Radio Law of Japan with respect to EVMs. Also, do not transfer EVMs, unless User gives the same notice above to the transferee. Please note that if User does not follow the instructions above, User will be subject to penalties of Radio Law of Japan.

【無線電波を送信する製品の開発キットをお使いになる際の注意事項】 開発キットの中には技術基準適合証明を受けていないものがあります。技術適合証明を受けていないものご使用に際しては、電波法遵守のため、以下のいずれかの措置を取っていただく必要がありますのでご注意ください。

1. 電波法施行規則第6条第1項第1号に基づく平成18年3月28日総務省告示第173号で定められた電波暗室等の試験設備でご使用いただく。
2. 実験局の免許を取得後ご使用いただく。
3. 技術基準適合証明を取得後ご使用いただく。

なお、本製品は、上記の「ご使用にあたっての注意」を譲渡先、移転先に通知しない限り、譲渡、移転できないものとします。

上記を遵守頂けない場合は、電波法の罰則が適用される可能性があることをご留意ください。日本テキサス・イ

ンスツルメンツ株式会社

東京都新宿区西新宿 6 丁目 2 4 番 1 号

西新宿三井ビル

3.3.3 *Notice for EVMs for Power Line Communication:* Please see http://www.tij.co.jp/lstds/ti_ja/general/eStore/notice_02.page

電力線搬送波通信についての開発キットをお使いになる際の注意事項については、次のところをご覧ください。 <https://www.ti.com/ja-jp/legal/notice-for-evaluation-kits-for-power-line-communication.html>

3.4 European Union

3.4.1 *For EVMs subject to EU Directive 2014/30/EU (Electromagnetic Compatibility Directive):*

This is a class A product intended for use in environments other than domestic environments that are connected to a low-voltage power-supply network that supplies buildings used for domestic purposes. In a domestic environment this product may cause radio interference in which case the user may be required to take adequate measures.

-
- 4 *EVM Use Restrictions and Warnings:*
 - 4.1 EVMS ARE NOT FOR USE IN FUNCTIONAL SAFETY AND/OR SAFETY CRITICAL EVALUATIONS, INCLUDING BUT NOT LIMITED TO EVALUATIONS OF LIFE SUPPORT APPLICATIONS.
 - 4.2 User must read and apply the user guide and other available documentation provided by TI regarding the EVM prior to handling or using the EVM, including without limitation any warning or restriction notices. The notices contain important safety information related to, for example, temperatures and voltages.
 - 4.3 *Safety-Related Warnings and Restrictions:*
 - 4.3.1 User shall operate the EVM within TI's recommended specifications and environmental considerations stated in the user guide, other available documentation provided by TI, and any other applicable requirements and employ reasonable and customary safeguards. Exceeding the specified performance ratings and specifications (including but not limited to input and output voltage, current, power, and environmental ranges) for the EVM may cause personal injury or death, or property damage. If there are questions concerning performance ratings and specifications, User should contact a TI field representative prior to connecting interface electronics including input power and intended loads. Any loads applied outside of the specified output range may also result in unintended and/or inaccurate operation and/or possible permanent damage to the EVM and/or interface electronics. Please consult the EVM user guide prior to connecting any load to the EVM output. If there is uncertainty as to the load specification, please contact a TI field representative. During normal operation, even with the inputs and outputs kept within the specified allowable ranges, some circuit components may have elevated case temperatures. These components include but are not limited to linear regulators, switching transistors, pass transistors, current sense resistors, and heat sinks, which can be identified using the information in the associated documentation. When working with the EVM, please be aware that the EVM may become very warm.
 - 4.3.2 EVMs are intended solely for use by technically qualified, professional electronics experts who are familiar with the dangers and application risks associated with handling electrical mechanical components, systems, and subsystems. User assumes all responsibility and liability for proper and safe handling and use of the EVM by User or its employees, affiliates, contractors or designees. User assumes all responsibility and liability to ensure that any interfaces (electronic and/or mechanical) between the EVM and any human body are designed with suitable isolation and means to safely limit accessible leakage currents to minimize the risk of electrical shock hazard. User assumes all responsibility and liability for any improper or unsafe handling or use of the EVM by User or its employees, affiliates, contractors or designees.
 - 4.4 User assumes all responsibility and liability to determine whether the EVM is subject to any applicable international, federal, state, or local laws and regulations related to User's handling and use of the EVM and, if applicable, User assumes all responsibility and liability for compliance in all respects with such laws and regulations. User assumes all responsibility and liability for proper disposal and recycling of the EVM consistent with all applicable international, federal, state, and local requirements.
 5. *Accuracy of Information:* To the extent TI provides information on the availability and function of EVMs, TI attempts to be as accurate as possible. However, TI does not warrant the accuracy of EVM descriptions, EVM availability or other information on its websites as accurate, complete, reliable, current, or error-free.
 6. *Disclaimers:*
 - 6.1 EXCEPT AS SET FORTH ABOVE, EVMS AND ANY MATERIALS PROVIDED WITH THE EVM (INCLUDING, BUT NOT LIMITED TO, REFERENCE DESIGNS AND THE DESIGN OF THE EVM ITSELF) ARE PROVIDED "AS IS" AND "WITH ALL FAULTS." TI DISCLAIMS ALL OTHER WARRANTIES, EXPRESS OR IMPLIED, REGARDING SUCH ITEMS, INCLUDING BUT NOT LIMITED TO ANY EPIDEMIC FAILURE WARRANTY OR IMPLIED WARRANTIES OF MERCHANTABILITY OR FITNESS FOR A PARTICULAR PURPOSE OR NON-INFRINGEMENT OF ANY THIRD PARTY PATENTS, COPYRIGHTS, TRADE SECRETS OR OTHER INTELLECTUAL PROPERTY RIGHTS.
 - 6.2 EXCEPT FOR THE LIMITED RIGHT TO USE THE EVM SET FORTH HEREIN, NOTHING IN THESE TERMS SHALL BE CONSTRUED AS GRANTING OR CONFERRING ANY RIGHTS BY LICENSE, PATENT, OR ANY OTHER INDUSTRIAL OR INTELLECTUAL PROPERTY RIGHT OF TI, ITS SUPPLIERS/LICENSORS OR ANY OTHER THIRD PARTY, TO USE THE EVM IN ANY FINISHED END-USER OR READY-TO-USE FINAL PRODUCT, OR FOR ANY INVENTION, DISCOVERY OR IMPROVEMENT, REGARDLESS OF WHEN MADE, CONCEIVED OR ACQUIRED.
 7. *USER'S INDEMNITY OBLIGATIONS AND REPRESENTATIONS.* USER WILL DEFEND, INDEMNIFY AND HOLD TI, ITS LICENSORS AND THEIR REPRESENTATIVES HARMLESS FROM AND AGAINST ANY AND ALL CLAIMS, DAMAGES, LOSSES, EXPENSES, COSTS AND LIABILITIES (COLLECTIVELY, "CLAIMS") ARISING OUT OF OR IN CONNECTION WITH ANY HANDLING OR USE OF THE EVM THAT IS NOT IN ACCORDANCE WITH THESE TERMS. THIS OBLIGATION SHALL APPLY WHETHER CLAIMS ARISE UNDER STATUTE, REGULATION, OR THE LAW OF TORT, CONTRACT OR ANY OTHER LEGAL THEORY, AND EVEN IF THE EVM FAILS TO PERFORM AS DESCRIBED OR EXPECTED.
-

8. *Limitations on Damages and Liability:*

8.1 *General Limitations.* IN NO EVENT SHALL TI BE LIABLE FOR ANY SPECIAL, COLLATERAL, INDIRECT, PUNITIVE, INCIDENTAL, CONSEQUENTIAL, OR EXEMPLARY DAMAGES IN CONNECTION WITH OR ARISING OUT OF THESE TERMS OR THE USE OF THE EVMS , REGARDLESS OF WHETHER TI HAS BEEN ADVISED OF THE POSSIBILITY OF SUCH DAMAGES. EXCLUDED DAMAGES INCLUDE, BUT ARE NOT LIMITED TO, COST OF REMOVAL OR REINSTALLATION, ANCILLARY COSTS TO THE PROCUREMENT OF SUBSTITUTE GOODS OR SERVICES, RETESTING, OUTSIDE COMPUTER TIME, LABOR COSTS, LOSS OF GOODWILL, LOSS OF PROFITS, LOSS OF SAVINGS, LOSS OF USE, LOSS OF DATA, OR BUSINESS INTERRUPTION. NO CLAIM, SUIT OR ACTION SHALL BE BROUGHT AGAINST TI MORE THAN TWELVE (12) MONTHS AFTER THE EVENT THAT GAVE RISE TO THE CAUSE OF ACTION HAS OCCURRED.

8.2 *Specific Limitations.* IN NO EVENT SHALL TI'S AGGREGATE LIABILITY FROM ANY USE OF AN EVM PROVIDED HEREUNDER, INCLUDING FROM ANY WARRANTY, INDEMNITY OR OTHER OBLIGATION ARISING OUT OF OR IN CONNECTION WITH THESE TERMS, , EXCEED THE TOTAL AMOUNT PAID TO TI BY USER FOR THE PARTICULAR EVM(S) AT ISSUE DURING THE PRIOR TWELVE (12) MONTHS WITH RESPECT TO WHICH LOSSES OR DAMAGES ARE CLAIMED. THE EXISTENCE OF MORE THAN ONE CLAIM SHALL NOT ENLARGE OR EXTEND THIS LIMIT.

9. *Return Policy.* Except as otherwise provided, TI does not offer any refunds, returns, or exchanges. Furthermore, no return of EVM(s) will be accepted if the package has been opened and no return of the EVM(s) will be accepted if they are damaged or otherwise not in a resalable condition. If User feels it has been incorrectly charged for the EVM(s) it ordered or that delivery violates the applicable order, User should contact TI. All refunds will be made in full within thirty (30) working days from the return of the components(s), excluding any postage or packaging costs.

10. *Governing Law:* These terms and conditions shall be governed by and interpreted in accordance with the laws of the State of Texas, without reference to conflict-of-laws principles. User agrees that non-exclusive jurisdiction for any dispute arising out of or relating to these terms and conditions lies within courts located in the State of Texas and consents to venue in Dallas County, Texas. Notwithstanding the foregoing, any judgment may be enforced in any United States or foreign court, and TI may seek injunctive relief in any United States or foreign court.

Mailing Address: Texas Instruments, Post Office Box 655303, Dallas, Texas 75265
Copyright © 2023, Texas Instruments Incorporated

IMPORTANT NOTICE AND DISCLAIMER

TI PROVIDES TECHNICAL AND RELIABILITY DATA (INCLUDING DATA SHEETS), DESIGN RESOURCES (INCLUDING REFERENCE DESIGNS), APPLICATION OR OTHER DESIGN ADVICE, WEB TOOLS, SAFETY INFORMATION, AND OTHER RESOURCES "AS IS" AND WITH ALL FAULTS, AND DISCLAIMS ALL WARRANTIES, EXPRESS AND IMPLIED, INCLUDING WITHOUT LIMITATION ANY IMPLIED WARRANTIES OF MERCHANTABILITY, FITNESS FOR A PARTICULAR PURPOSE OR NON-INFRINGEMENT OF THIRD PARTY INTELLECTUAL PROPERTY RIGHTS.

These resources are intended for skilled developers designing with TI products. You are solely responsible for (1) selecting the appropriate TI products for your application, (2) designing, validating and testing your application, and (3) ensuring your application meets applicable standards, and any other safety, security, regulatory or other requirements.

These resources are subject to change without notice. TI grants you permission to use these resources only for development of an application that uses the TI products described in the resource. Other reproduction and display of these resources is prohibited. No license is granted to any other TI intellectual property right or to any third party intellectual property right. TI disclaims responsibility for, and you will fully indemnify TI and its representatives against, any claims, damages, costs, losses, and liabilities arising out of your use of these resources.

TI's products are provided subject to [TI's Terms of Sale](#) or other applicable terms available either on [ti.com](https://www.ti.com) or provided in conjunction with such TI products. TI's provision of these resources does not expand or otherwise alter TI's applicable warranties or warranty disclaimers for TI products.

TI objects to and rejects any additional or different terms you may have proposed.

Mailing Address: Texas Instruments, Post Office Box 655303, Dallas, Texas 75265
Copyright © 2023, Texas Instruments Incorporated