

Using Ultrasonic Sensing to Monitor Level in Tanks

Matthew Minasi

ABSTRACT

Ultrasonic sensing Time Of Flight (TOF) measurement techniques can be utilized to measure fluid levels in tanks. Those measurements can either be done from inside or outside the wall of the tank. In automotive, industrial and even medical applications the ability to perform non-invasive measurements is driven from the target fluid's corrosiveness and/or sterile requirements. This application note describes how to utilize the TDC1000 and piezoelectric ultrasonic transducer to perform highly accurate fluid level measurements on a tank externally.

Topic	Page
1 System Requirements	2
2 Approach	3
3 Implementation	4
4 Conclusion	27
5 Tools and Resources	27

1 System Requirements

The requirements are:

1. Measure water level non-invasively (for corrosive or sterile fluids) in a container
2. Tank material: plastic or metalized plastic
3. Maximum height: 20cm
4. Minimum height: 2cm
5. Accuracy: 1mm
6. Frequency of measurement: 10 samples per sec
7. No moving parts
8. High reliability to environmental factors

2 Approach

There are several methods for noninvasive level measurement. However only ultrasonic TOF techniques can measure tank levels from outside conductive tank walls, which is the case for metalized plastic. Ultrasound has no moving parts and using a 1 MHz transducer will yield sub-mm accuracy. Ultrasound also isn't affected by external electric field changes which can be an issue with other sensing technologies.

Ultrasonic TOF level measurement works by using a single piezoelectric transducer to create a pulse from the bottom of a tank. That pulse travels through the tank wall, through the fluid in the tank until it reaches the fluid surface. At the fluid surface (fluid to air interface) an echo is created. Measuring how long it takes for the echo to return is referred to as TOF (Time Of Flight) measurement.

At the highest level an ultrasonic level measuring system consists of a signal transmitter, signal receiver and signal transmission path. The signal that needs to be detected reliably is the ultrasonic echo that is created at the acoustic boundary between the material level we are measuring (liquid) and the lack of it (air etc.). The ultrasonic TOF measurement system will have 3 parts (as shown in Figure 1), the piezo electric transducer, the analog front end (AFE) which interfaces between the transducer and the microprocessor. The AFE drives the transducer and converts the analog echo signals into digital signals that represent the beginning (START) and end (STOP) of the TOF measurement. The microprocessor controls the analog interface, measures the time delta between the Start and Stop signals and processes the TOF information created by the AFE into a liquid level value.

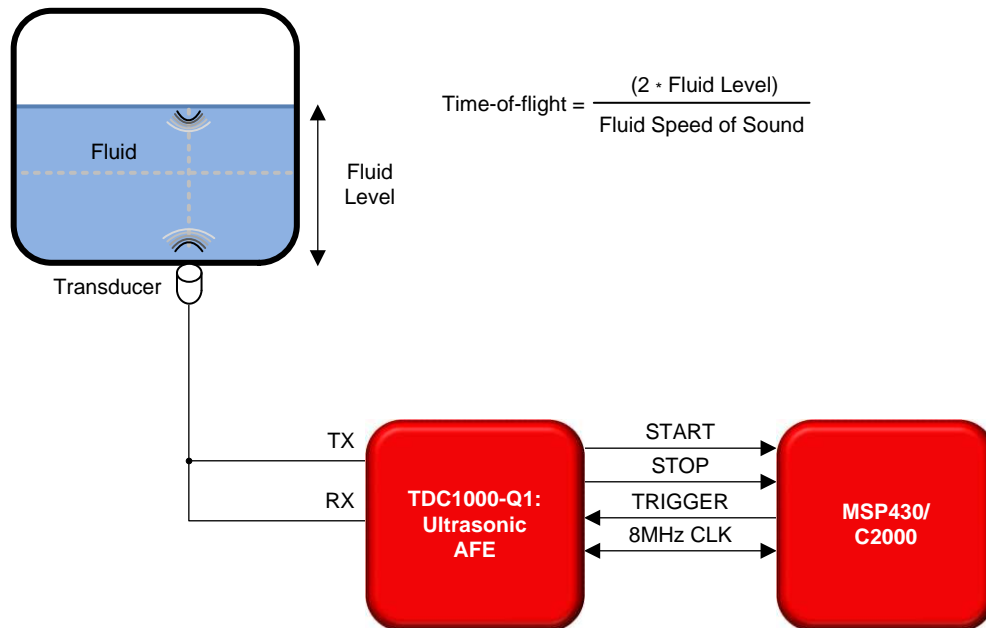

Figure 1. Ultrasonic Level Block Diagram

3 Implementation

System Design Challenges

Section 3 describes the challenges regarding architecture choices in designing an ultrasonic level system. Those tradeoffs are: transducer selection (what size) , TDC1000 configuration (transmit and receive configuration), high or low voltage excitation, single or resonant excitation and finally physical tank features that can help performance.

3.1 Transducer Selection

When selecting a transducer the parameters that determine which is right for the application are: resonant frequency, transducer diameter, and packaging.

Transducer diameter has the largest impact as it is both the transmitter and the receiver for our signal chain. In general use the largest transducer that fits your application.

For this fluid measurement application, external to the tank, the lowest cost solution is to choose an unsealed transducer, with a 1Mhz resonant frequency to yield easy sub-mm level resolution. Three transducer diameters tested were 7mm, 10mm and 15mm.

They are the following:

Dia (mm)	Model Number	Website
7	BPU-P7-1000B-W200	www.bestartech.com
10	SMD10T2R111WL	https://www.steminc.com/PZT/en/piezo-ceramic-disc-10x2mm-r-215-khz-wire-leads-smd10t2r111wl
15	SMD15T21R111WL	https://www.steminc.com/PZT/en/piezo-ceramic-disc-1-mhz

3.2 Transducer Mounting

The transducers were mounted as described in App note [How to Select and Mount Transducers in Ultrasonic Sensing for Level Sensing and Fluid ID](#) on the bottom of the tank.

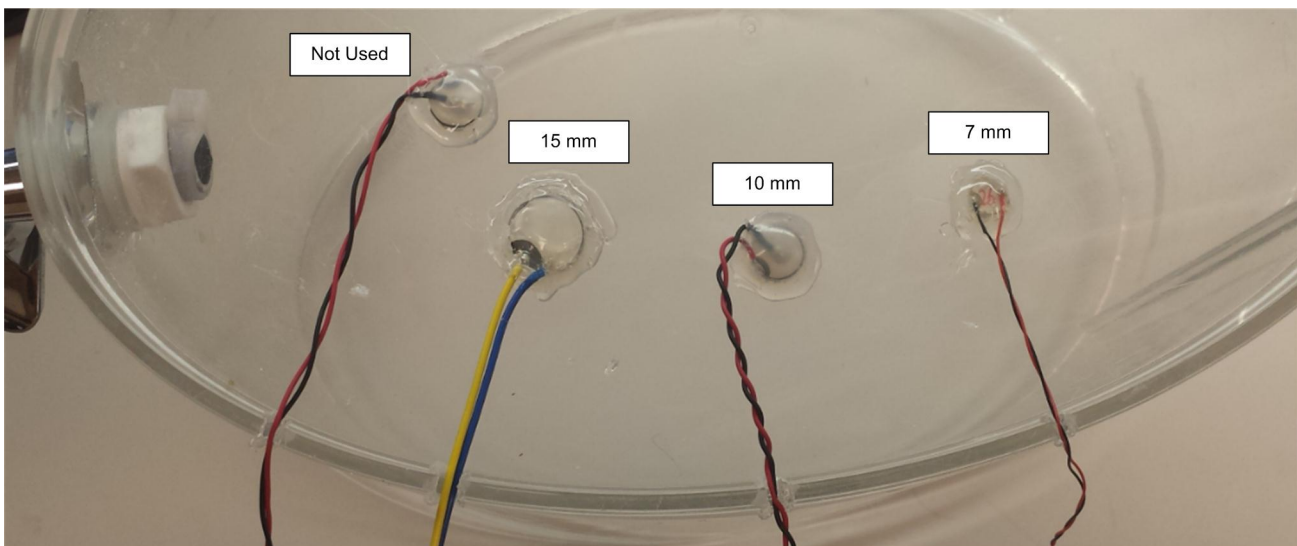

3.3 Making Measurements

Measurements were taken with approximately 3cm of water in the tank. Using our test container and TDC1000-C2000EVM the default configuration and resulting signals are described below.

3.3.1 TDC1000 Configuration

The TDC1000 platform used here is the TDC1000-C2000 EVM. To properly configure the TDC1000, an oscilloscope is required to measure echo amplitudes (COMPIN_BUF), START and STOP pulse creation. For our testing the setup is as follows:



TDC1000 signals connected as follows: START(TP23):(Ch1), STOP(TP22):(Ch2), COMPIN_BUF(TP21):Ch3.

Transducer is connected to TX1/RX2 J5-pins 10 and 9.

3.3.2 Default Settings

The default settings for the TDC1000-C2000 EVM are set for the 10mm transducer in the list. A 3cm level is a good place to start to access the performance of your transducer. The TDC1000 needs to start measurements before the waveforms can be seen on the oscilloscope. To do this, toggle the switch on the GUI as shown below to turn it green.

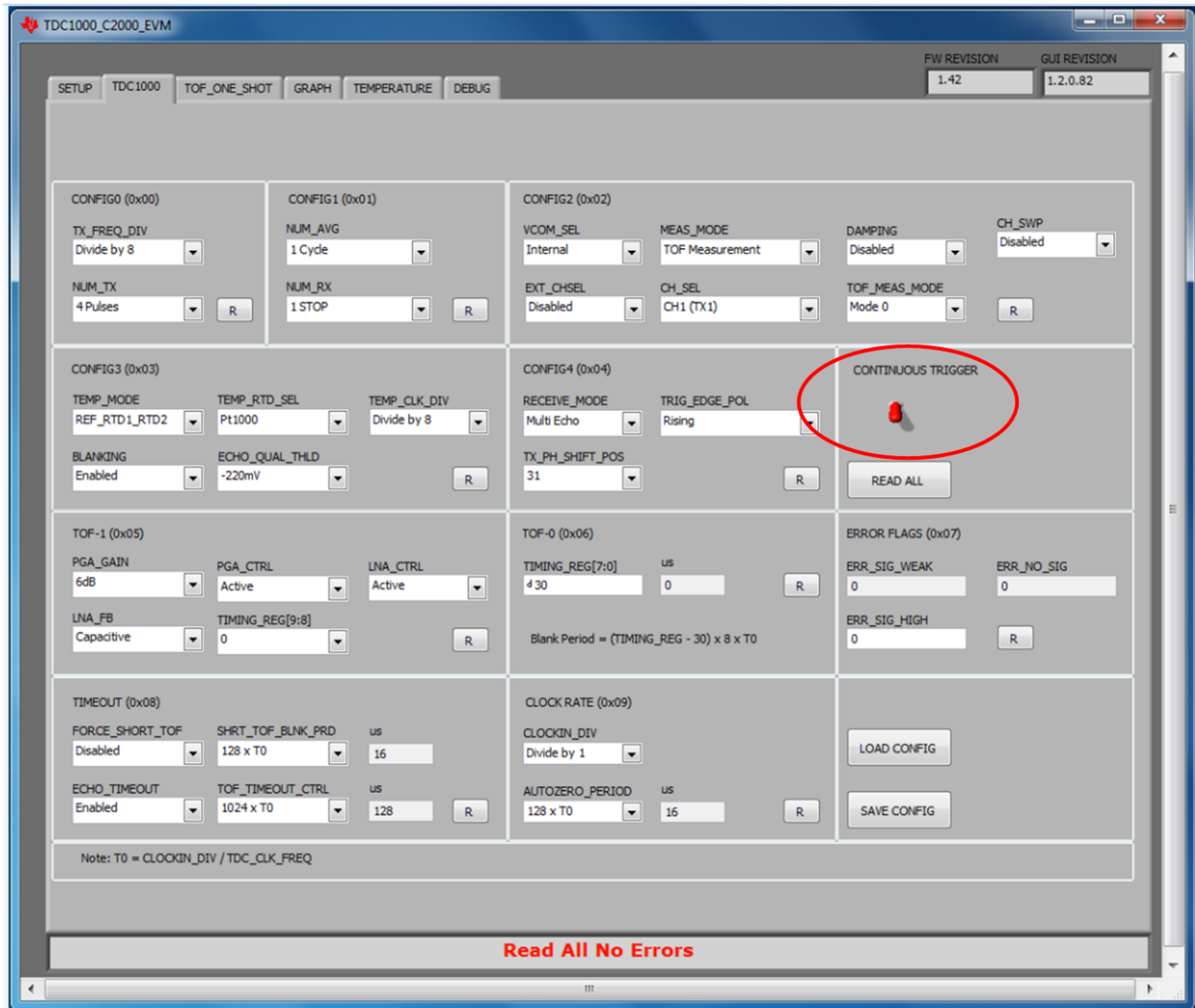

Below is an oscilloscope picture showing the TDC1000 signals once the EVM is in continuous measurement mode.

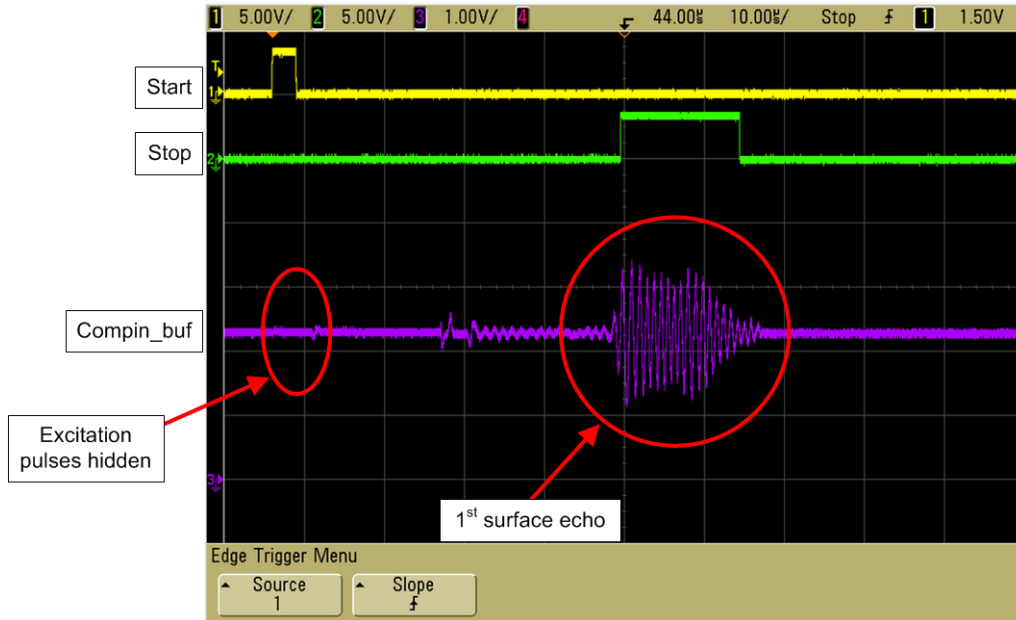

TDC1000 signals are connected as follows: START(TP23):(Ch1), STOP(TP22):(Ch2), COMPIN_BUF(TP21):Ch3

Note the timing relationship from Start to Stop with respect to the amplified echo on CH3. In the default mode the TDC1000 will create a Stop pulse that lasts for the duration of the echo such that the amplitude of the echo is greater than the programmed Voltage threshold. For more detail, see the TDC1000 data sheet ([TDC1000: Ultrasonic Analog-Front-End](#)) section 8.4.4.2.

3.3.3 Transducer Ringdown

Now that a working echo is seen the next step is to understand how much the ringdown our transducer has as it can be a limiting factor on signal detection on the low side and high side of the level measurement. Ringdown is the mechanical “ringing” of the transducer even after the TDC1000 has stopped exciting it. Piezoelectric transducers can be viewed as very specific RLC resonant filters and as such once they are “excited” or stimulated via an external voltage pulse it will take a specific amount of time to stop. With the single transducer topology (as used in level applications) the transducer is the speaker as well as the microphone and the ringdown needs to stop or reduce in order for the transducer to “hear” an echo. The transducers ringdown is the largest factor to defining minimum level detectable.

Setting the following configuration registers as shown will enable this to be measured.

TDC1000 tab with changed registers highlighted here.

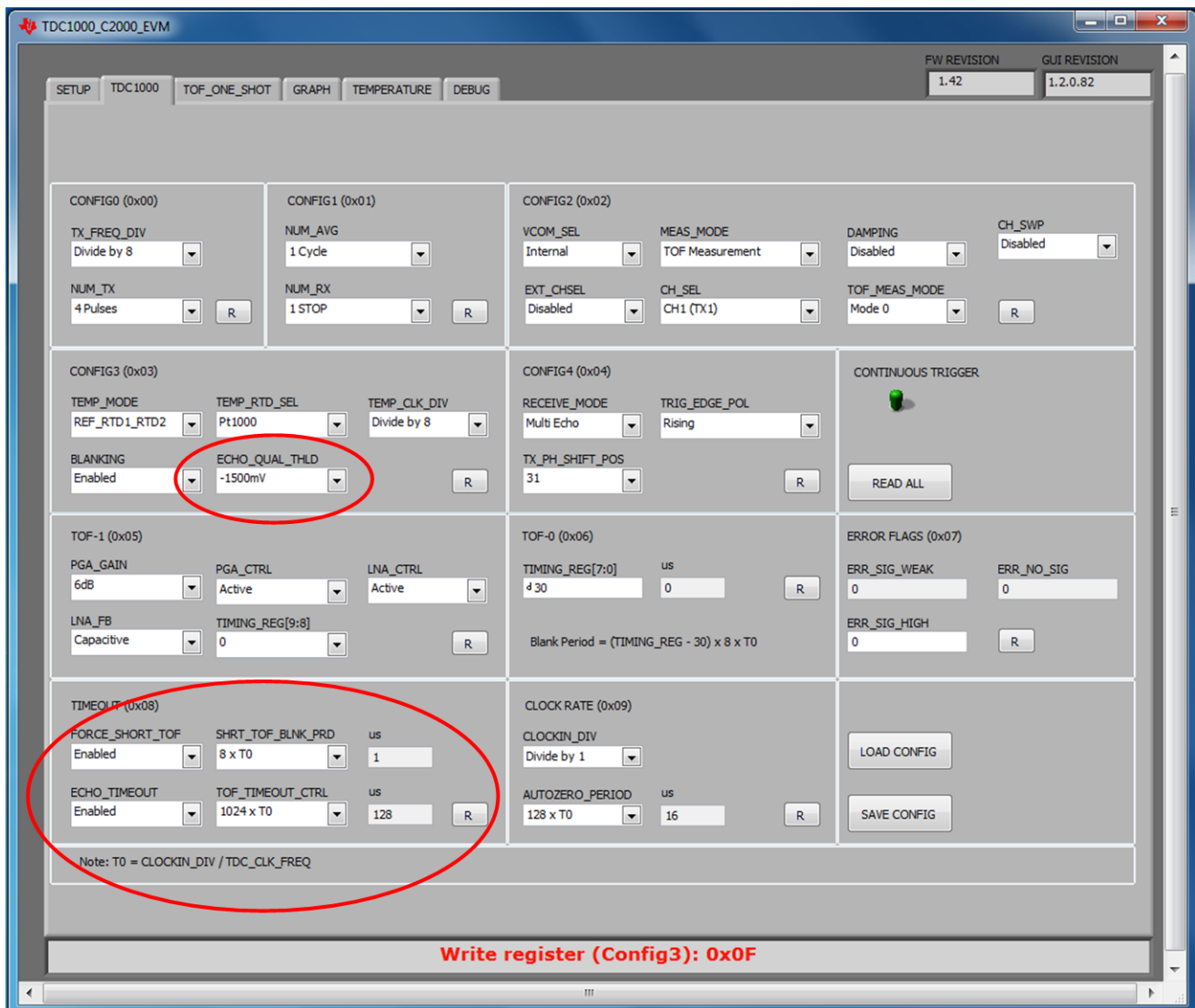

3.3.4 Timeout Register

The specific fields changed are “Enable Short TOF and ShortTOF Blanking = 1us. These changes allow the receive channel to observe and respond to the echo 1us after the “excitation phase” is completed. In terms of distance, this means echos that are less than 1mm in front of the transducer. For this example this is unusable but can be used to illustrate the behavior of the transducer.

3.3.5 Config3 Register

The specific bit field changed was “Echo_Qual_Thld” which determines the minimum voltage level for the echo that will trigger the STOP pulse creation. Here it has been increased to -1500mv which disables Stop pulse creation. It is useful to do this as depending on other register settings the receive circuit can be turned off after the echo has been detected and the Stop pulse created. This can also be achieved by setting the Config1 register “Num_rx” bit field to “No RX Event count”.

Below is a scope picture showing the TDC1000 signals.

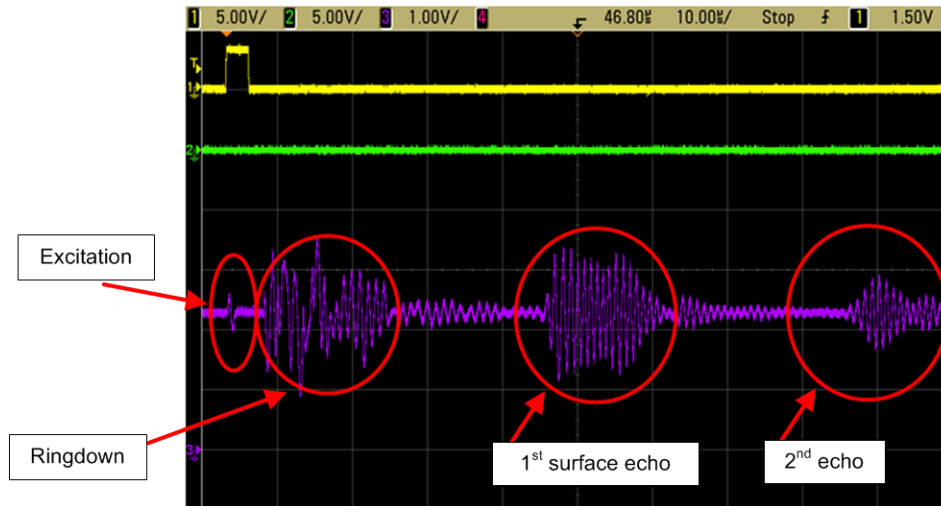

Note the ringdown section of the waveform occurs right after excitation completes.

Now that we’ve seen “ringdown” is seen you can reduce it for any given transducer is by using mechanical dampening techniques and/or reducing the excitation time. The result of additional dampening will be a less efficient, less sensitive transducer that will stop “ringing” sooner. The “excitation time” for the above example was 4us or 4 pulses from the TDC1000. See below:

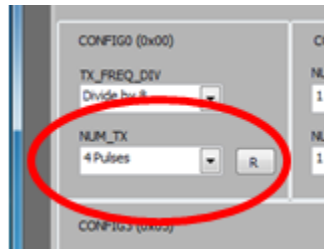

We can reduce the number of pulses to shorten the ringdown but that can also reduce our transmit signal amplitude (see section TX below). To get the shortest ringdown reducing the number of TX pulses to 1 which yields the following waveform:

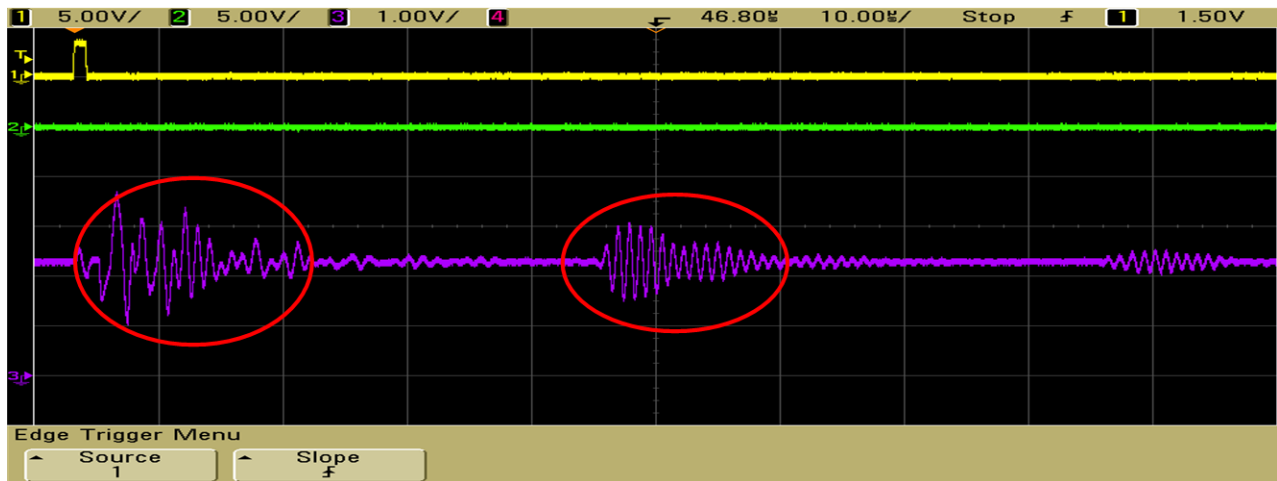

To illustrate ringdown versus echo reducing the water level down to 1cm shows the relative size of the water surface echo versus ringdown.

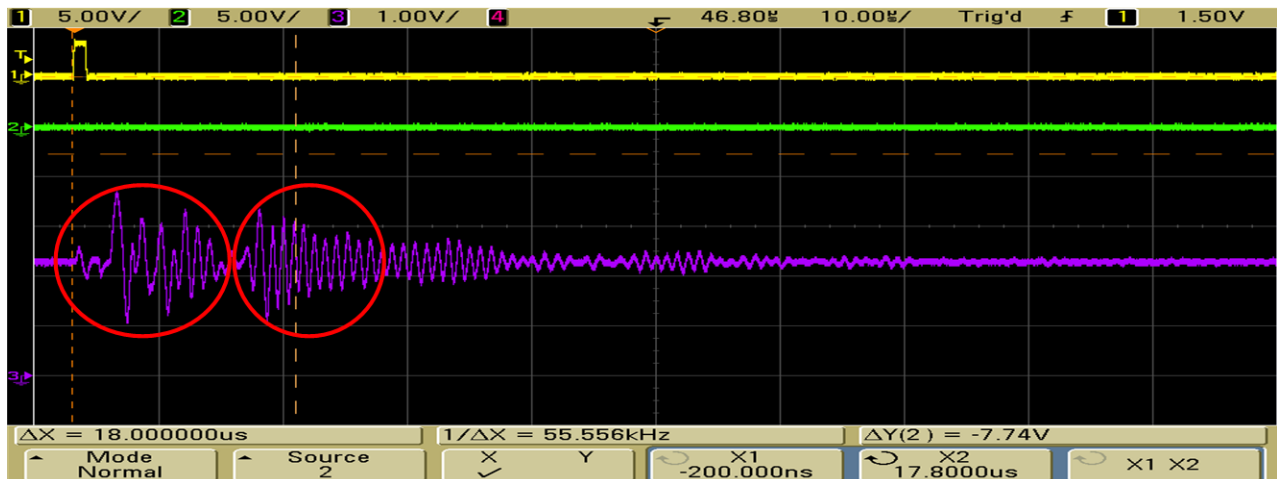

Another approach with the TDC1000 is to use “autozero” to electronically “blank out” a programmable time period after the START pulse when the TDC1000 will “ignore” the echo. This method limits how close to “tank empty scenario” that can be measured. To maximize low level sensitivity “blanking time” should be minimized. However, the downside to this approach is as the level increases in taller tanks the echo amplitude at max level approaches the “ringdown amplitude” and therefore makes it difficult to distinguish between the two. This is what is referred to as a “false echo”. So it will be a tradeoff between low level sensing and maximum level sensing.

3.3.6 Autozero in Practice

This section illustrates how to use “Autozero” to set the lowest detection level for this system. Without changing Gain settings the following Figures 2-4 demonstrate the effect of Autozero on the echo. Note how as the Autozero time is increased the ringdown amplitude is reduced.

In Figure 5 $V_{threshold}$ was reduced to re-enable STOP pulse creation. In Figure 6 the water level was then reduced to illustrate the lowest level detectable. Register settings for this are shown in Figure 7.

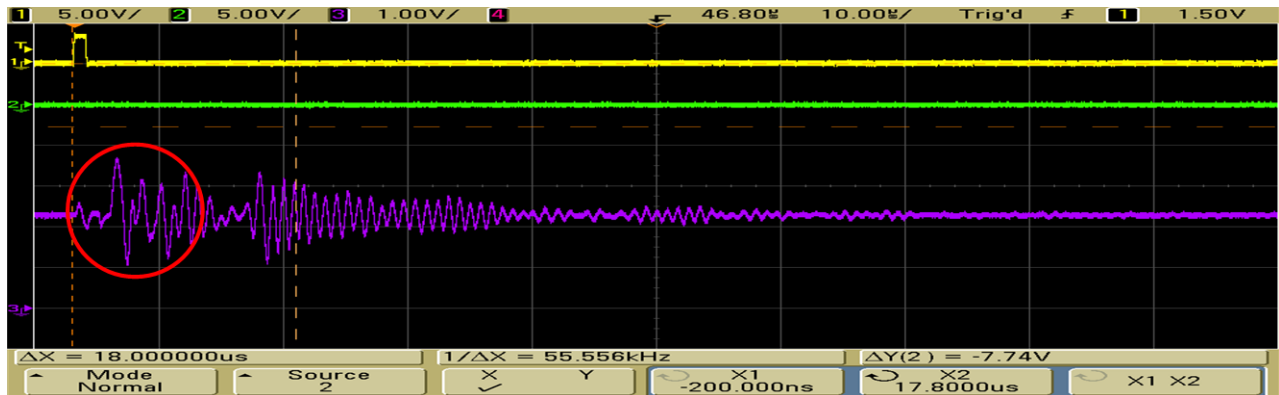

Figure 2. Autozero @ 2us

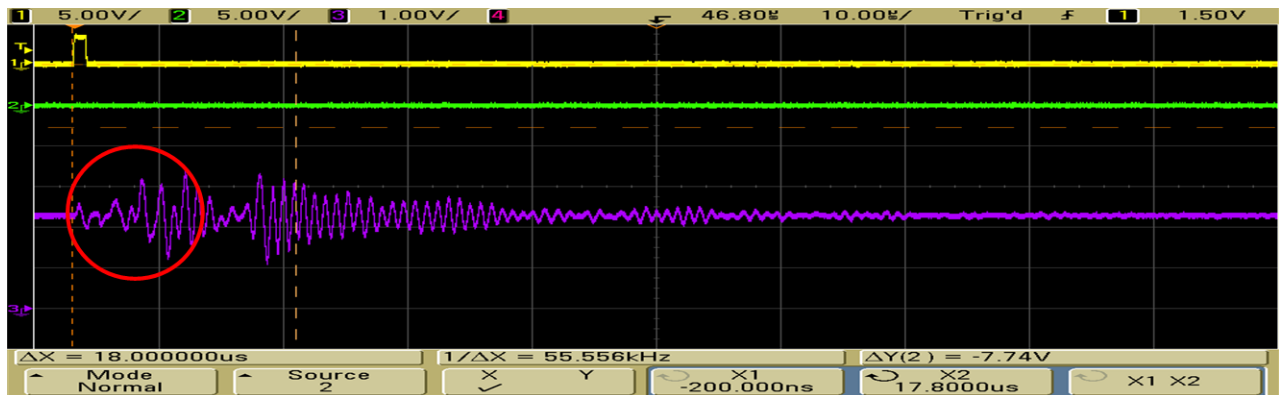

Figure 3. Autozero @ 4us

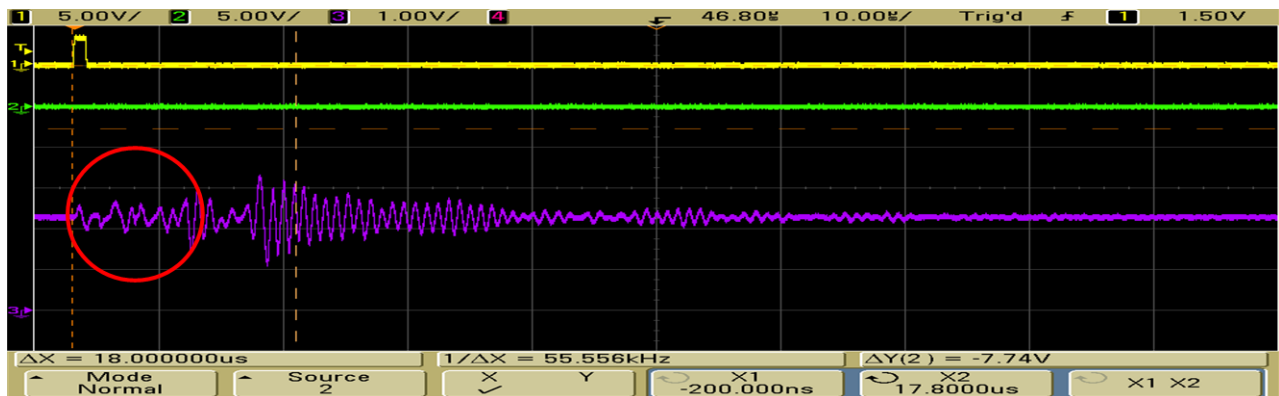

Figure 4. Autozero @ 8us

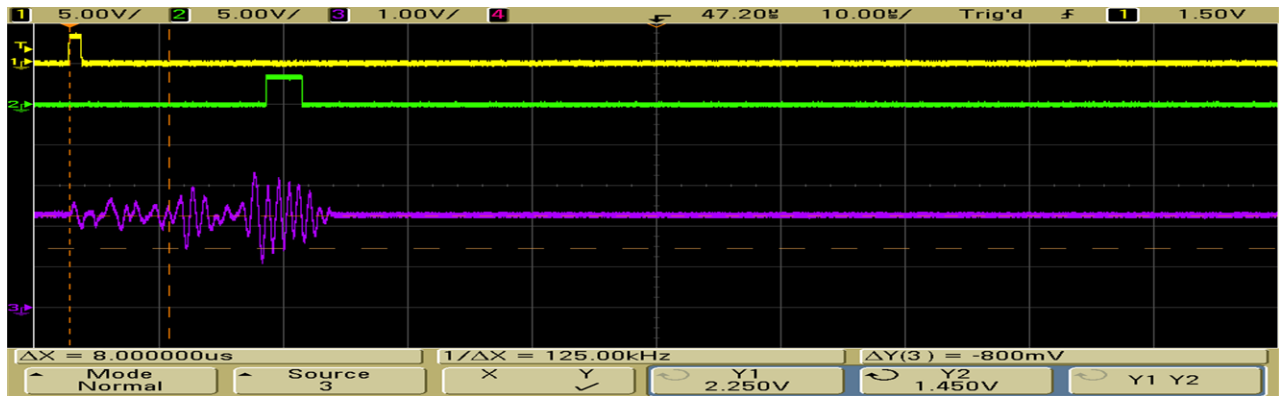

Figure 5. VThreshold Reduced to Enable STOP Pulse

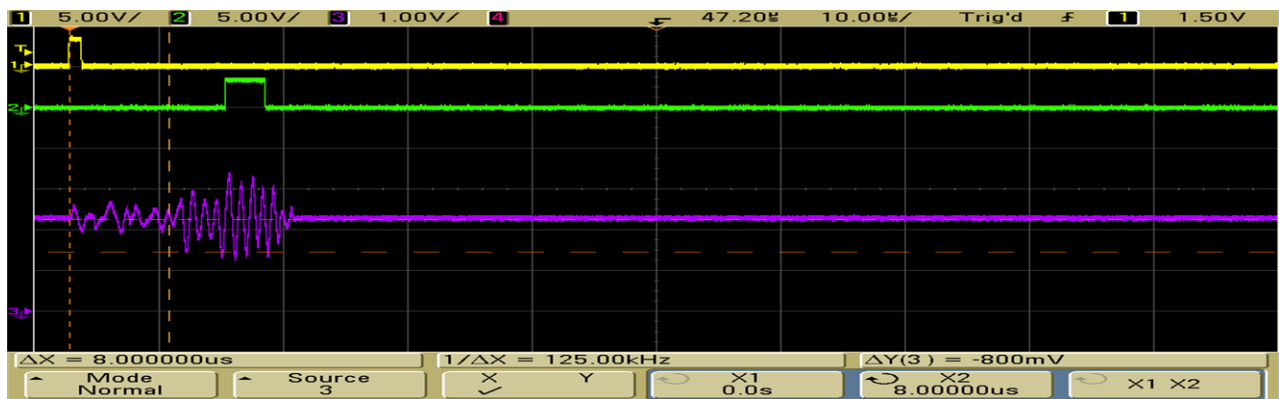

Figure 6. Water Level Reduced to Show Echo and Ringdown Mixing (Lowest Measurable Level)

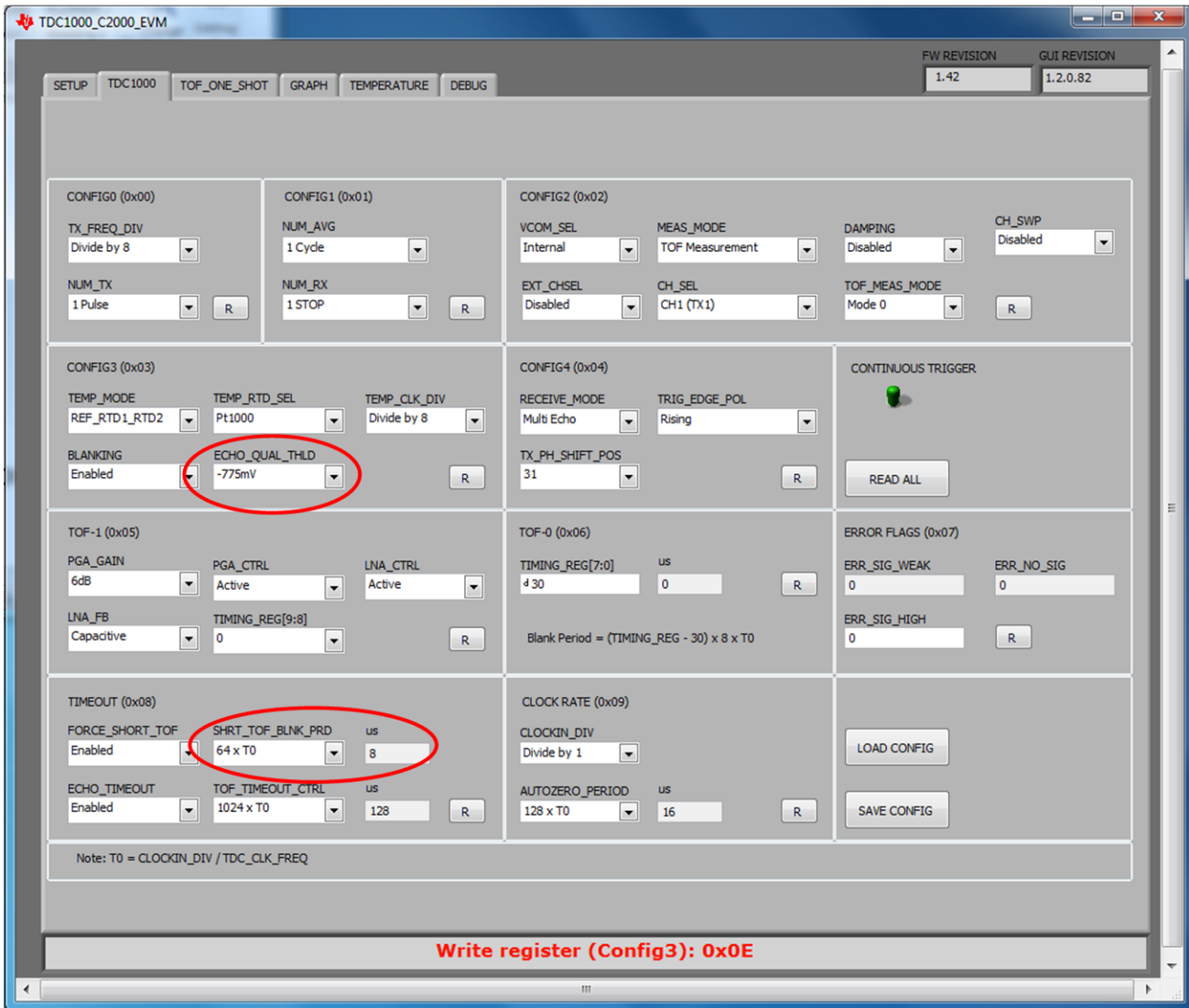

Figure 7. GUI Settings for Above

NOTE: By using ShortTOF, 8us blanking and -775mV Echo_qual_thld sub-1cm level detection is possible.

The following scope picture is from the same setup as above with only the $V_{threshold}$ lower (-410). This configuration would yield Stop pulses that do not show the correct level. Note that the STOP pulse is occurring during ringdown.

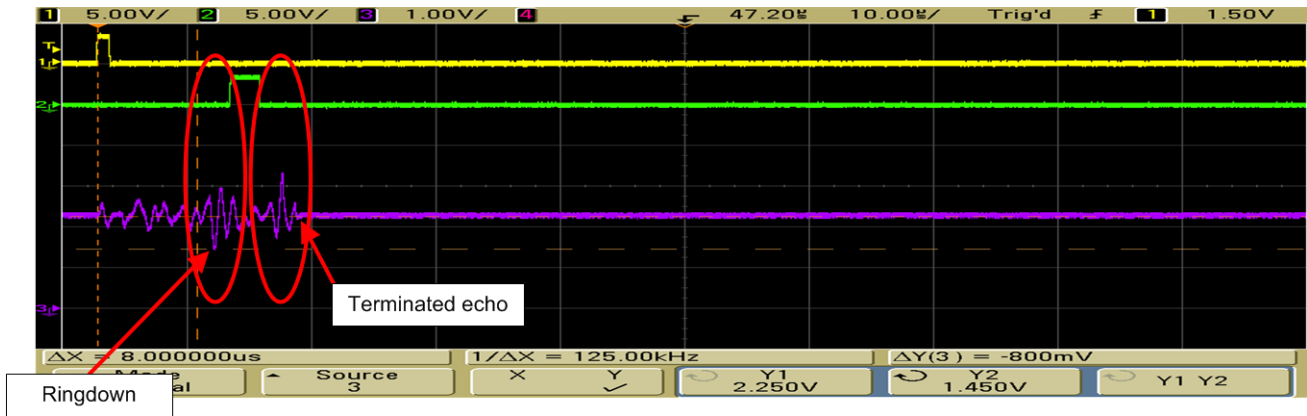

Figure 8. False Echos

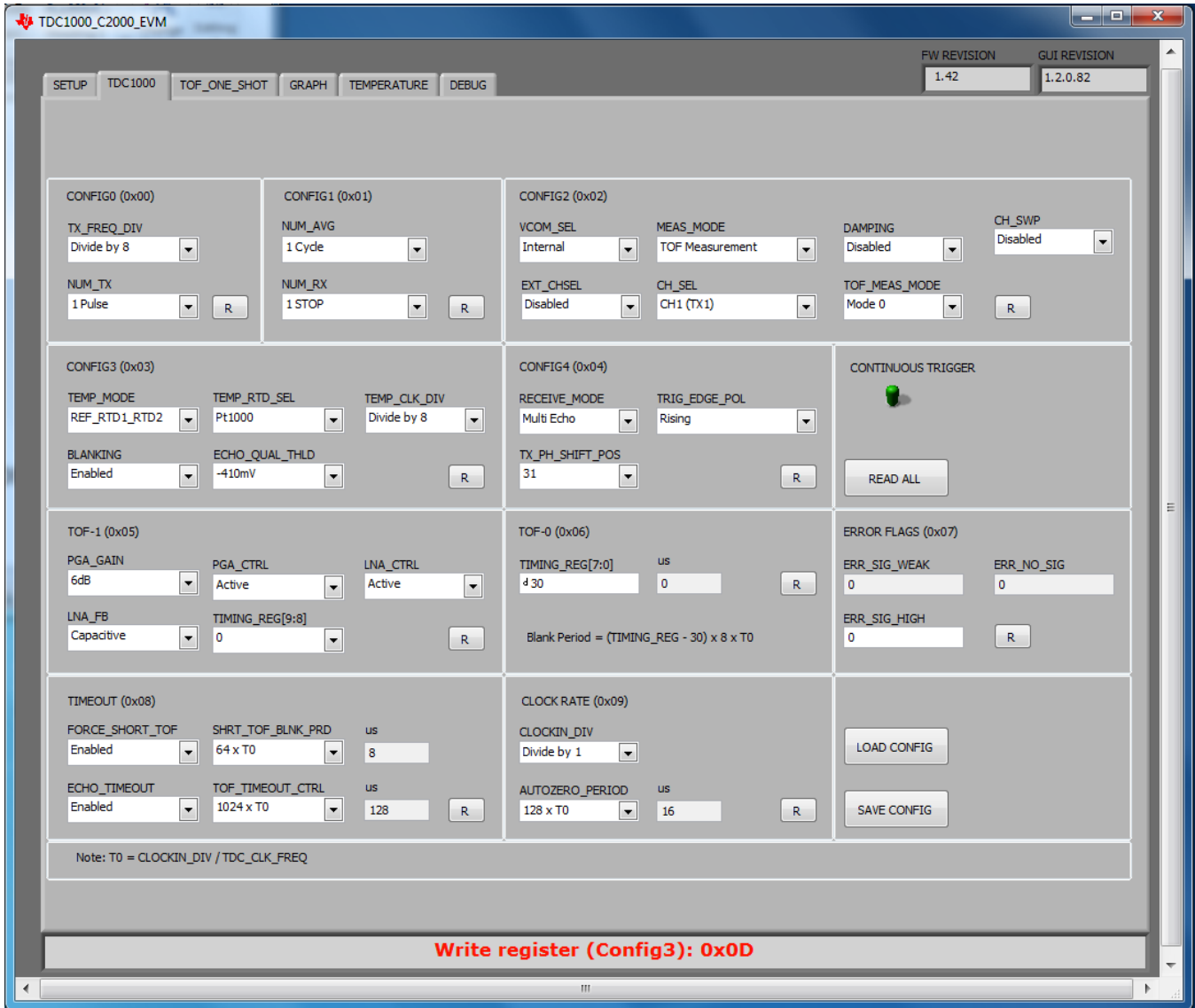

Figure 9. False Echo GUI Settings

In the “false echo” case above, the STOP pulse circuitry triggered on the ringdown and then shutoff as the NUM_RX was set to one. This shows the importance of choosing the correct threshold and blanking to filter out false echoes from transducer ringdown.

3.3.7 Ringdown for Different Size Transducers for the Same Settings

The following three measurements were acquired using the exact same TDC1000 register settings using three different sized transducers.

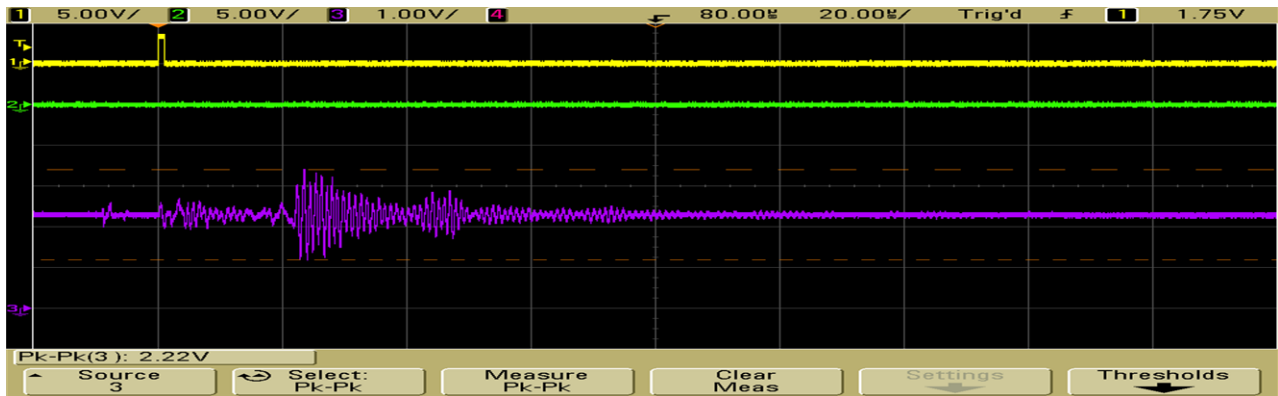

Figure 10. With the 15cm Transducer

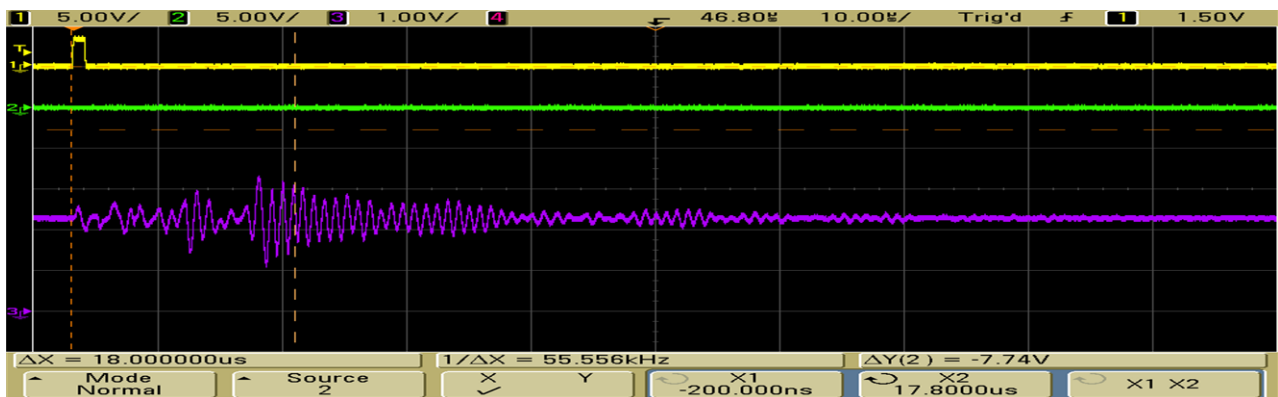

Figure 11. With the 10mm Transducer

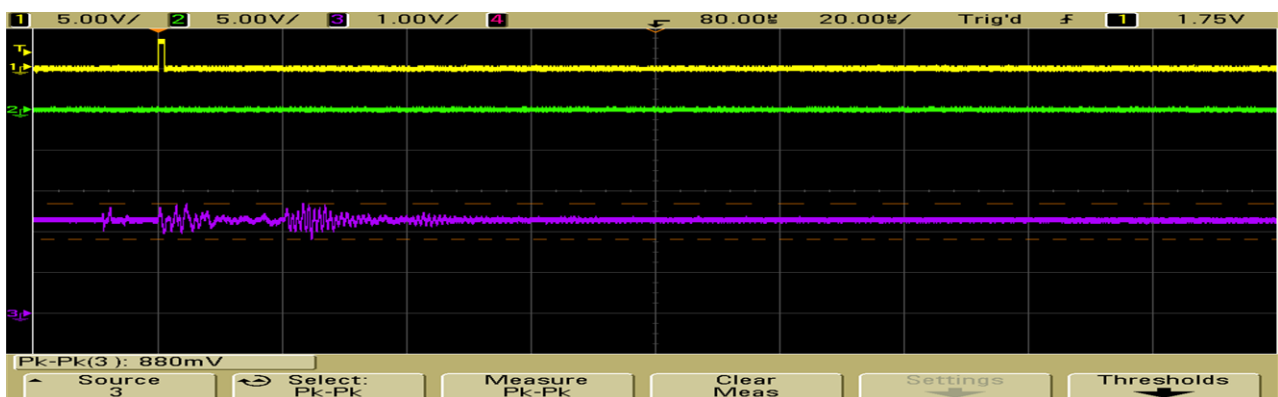

Figure 12. With a 7mm Transducer

Looking at the three scope pictures in Figs 10-12 it can be observed that as the transducer size increases so too does the desired signal (the echo) versus the ringdown. Thus the signal to noise ratio increases with transducer size.

3.3.8 Looking Beyond the Low End Measurement and Ringdown

ShortTOF mode was utilized in the previous section to observe transducer ringdown and how it can be controlled. However ShortTOF mode will limit the maximum range the TOF measurement can take. A TDC1000 with an 8Mhz input clock, in ShortTOF mode can only measure up to 128us for a TOF measurement. Level measurements NOT requiring ShortTOF mode enables the TDC1000 to measure TOFs up to approximately 2ms.

As most level applications have these requirements this section describes the register setting changes to enable those longer TOF measurements.

3.3.9 Setting the GUI for Non-ShortTOF Measurements

The GUI settings below are for typical level applications where a minimum level of 1.5cm up to 20cm are required.

Note the changes are to the following registers:

- Config3: Blanking disabled: as blanking doesn't apply to this application since the echo will need to be detected anywhere from 1.5 to 20cm.
- TOF-1: TimingREG[9:8] = 3
- TOF-1: TimingREG[7:0] = 255 These 10 bits determine the maximum amount of time the TDC1000 will allow for the echo to be detected before an error is set in the ERROR_FLAGS register. In this case I've maximized the time to 993us as the GUI calculates.
- Timeout: ShortTOF is disabled
- Clockrate: Autozero period has been set to 16us to blank out ringdown allowing me to increase Gain as needed to detect the echo from the maximum tank level. At this setting the earliest echo should be at approximately 1.1cm in front of the transducer. $(1480 \text{ m/s}) * (16e-6 \text{ s}) / 2 = .0118 \text{ m}$

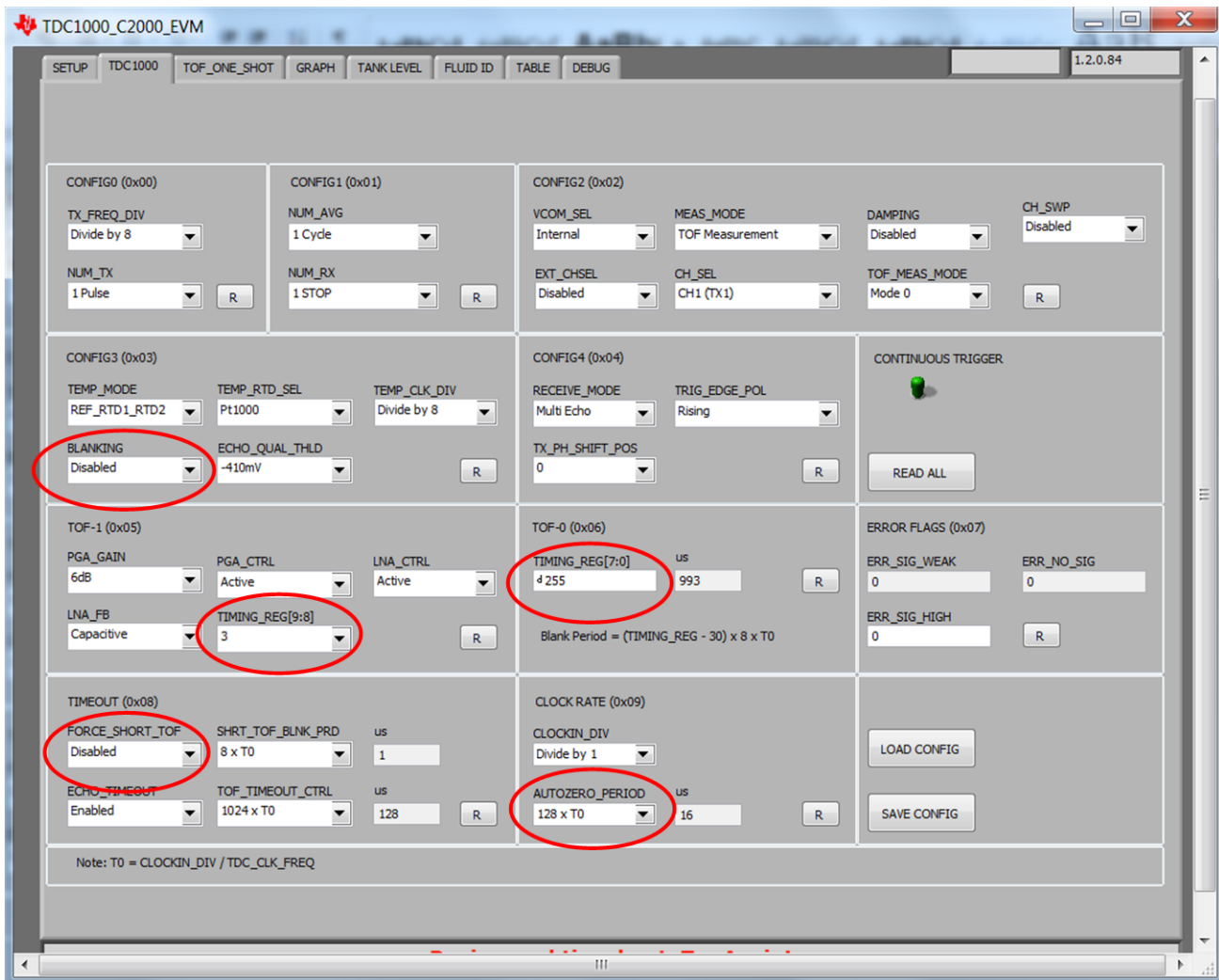

3.3.10 Level Detection on the High End

Thus far the focus has been on the low end of level detection. This section focuses on how to maximize the signal to noise ratio for the TDC1000 to detect echoes on the maximum height end. The challenge so far has been how to deal with transducer ringdown and how it affects the ability to distinguish between real echoes and false ones. There are two ways to increase the output signal for a transducer. The transducer can be excited “harder” by using greater excitation voltage or the transducer can be excited resonantly. The following slides show the effects of both options for all three of the transducer sizes we’ve looked at so far.

3.3.11 The Effect of Resonant Excitation

The slides that follow show the resultant echo with the 10mm transducer while increasing the number of excitation pulses sequentially. The water level was increased to 7cm and all transducers' performance were measured at the same water level.

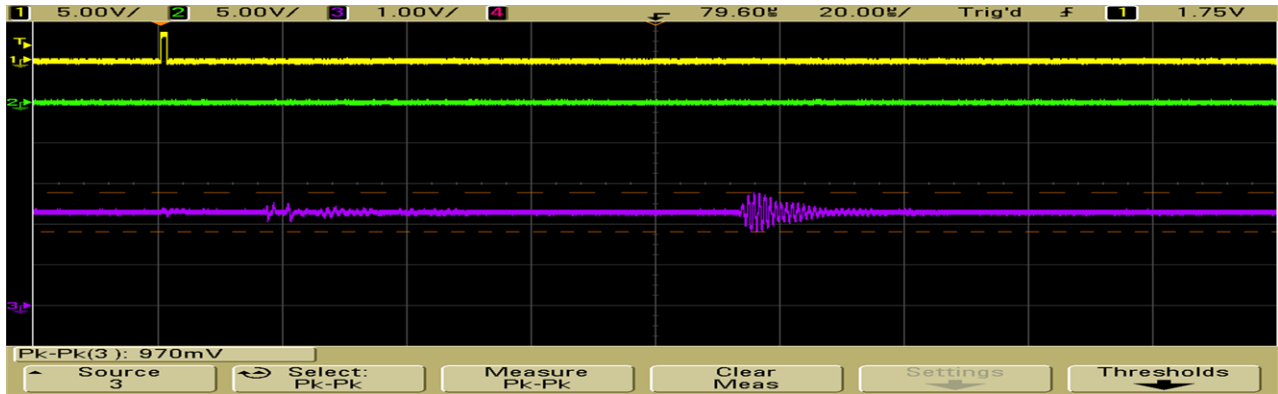

Figure 13. 10mm Transducer with 1 Pulse

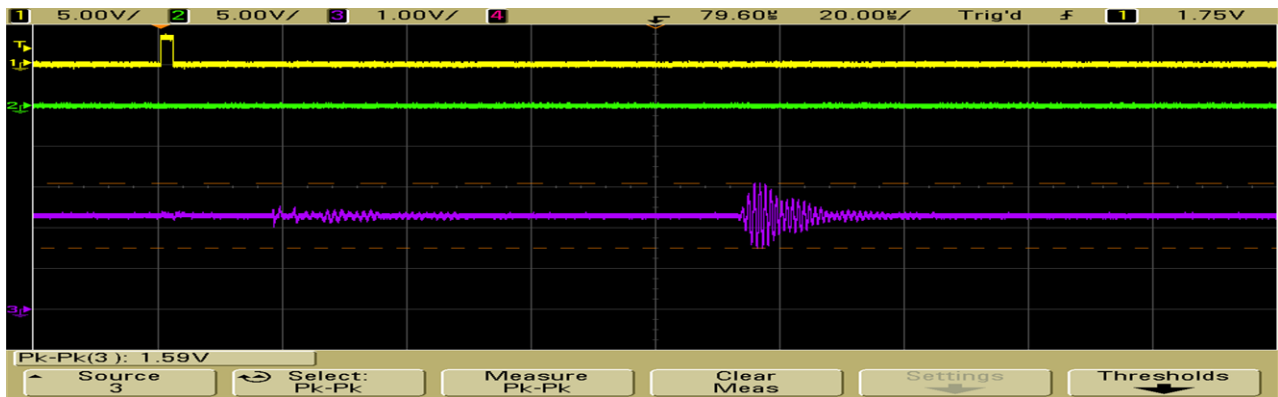

Figure 14. 10mm Transducer with 2 Pulses

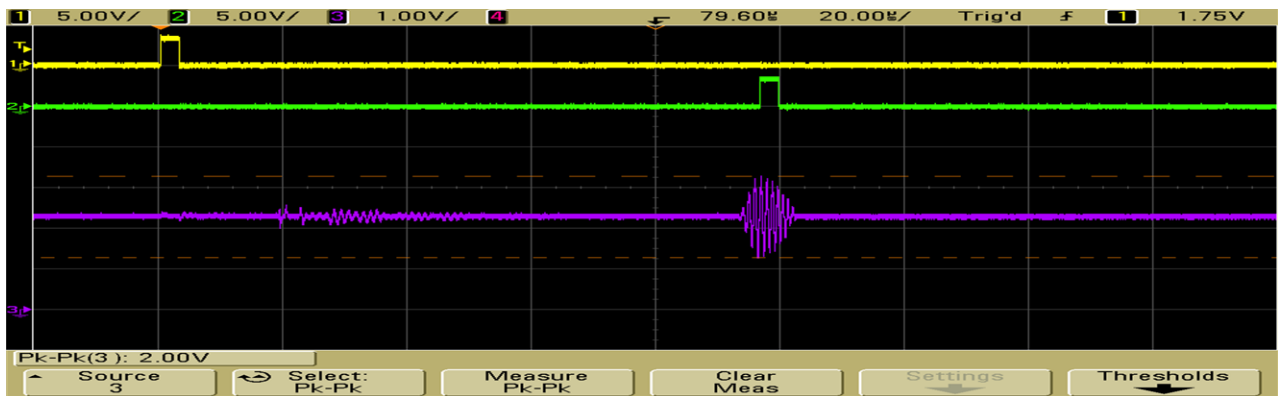

Figure 15. 10mm Transducer with 3 Pulses

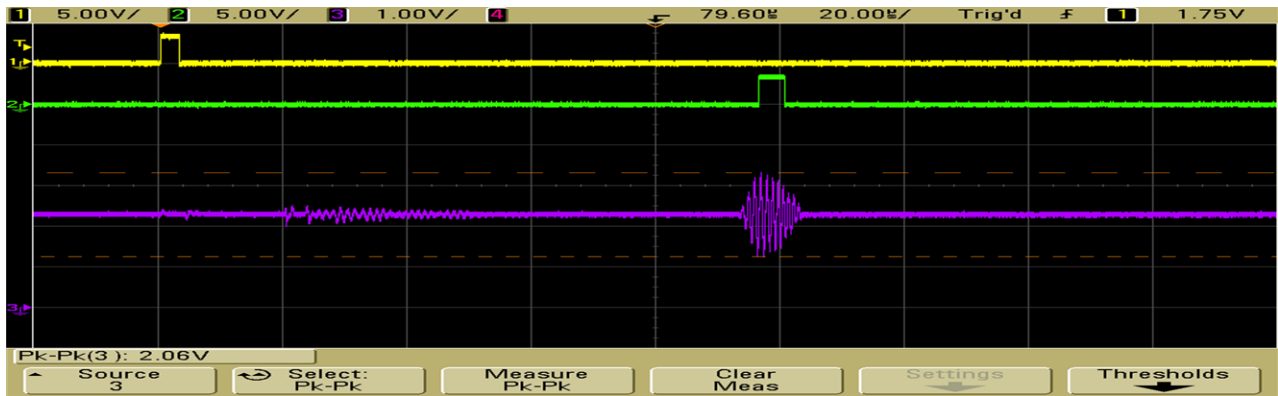

Figure 16. 10mm Transducer with 4 Pulses

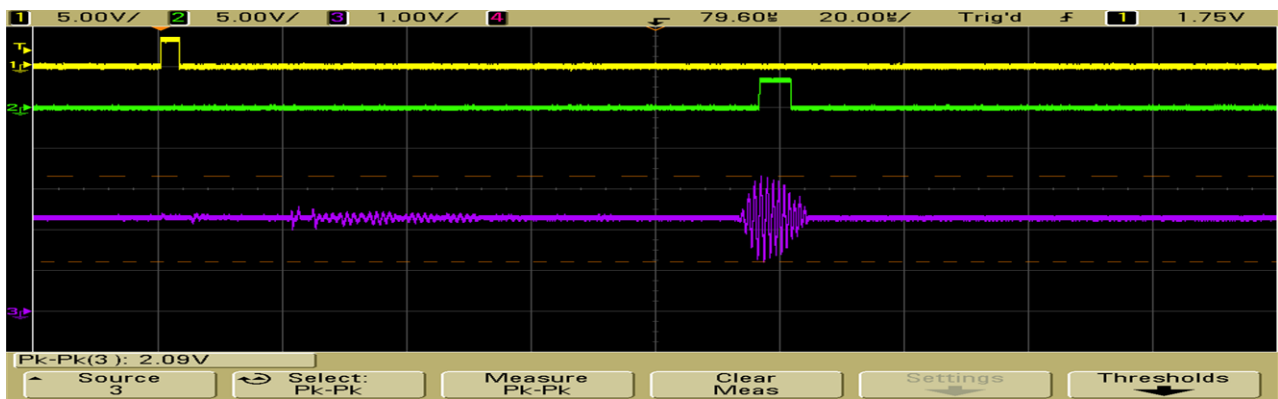

Figure 17. 10mm Transducer with 5 Pulses

As the number of pulses increases, note the amplitude reaches a maximum at 4 pulses. Additional pulses just extend the echo length without significantly increasing the echo amplitude.

Table 1. Excitation Pulses vs. Echo Amplitude for 10mm Transducer

Number of Pulses	Echo (V)
1	.97
2	1.59
3	2.0
4	2.06
5	2.09

Performing the same experiment with the 7mm and 15mm transducers yielded the following results.

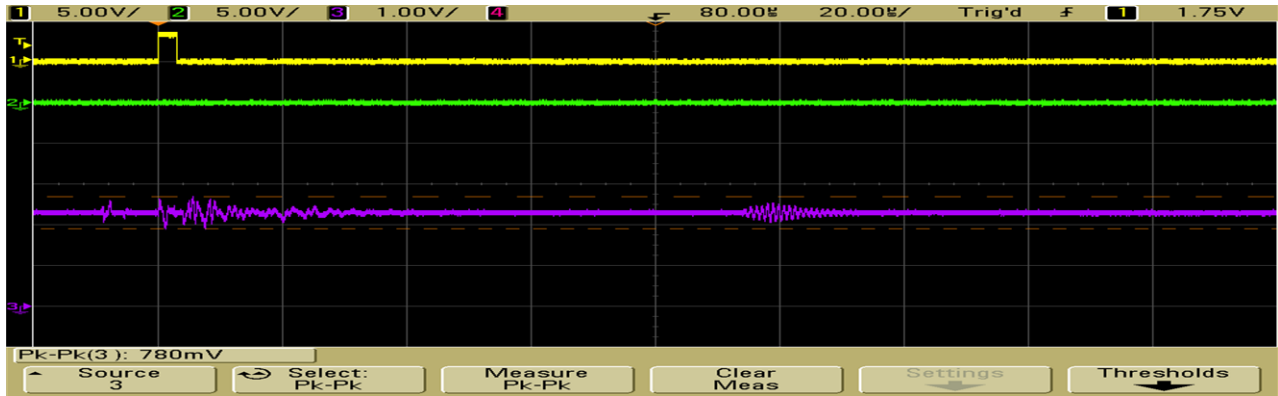

Figure 18. 7mm Transducer: Max Signal at 5 Pulses

Table 2. Excitation Pulses vs. Echo Amplitude for 7mm Transducer

Number of Pulses	Echo (V)
1	.25
5	.5

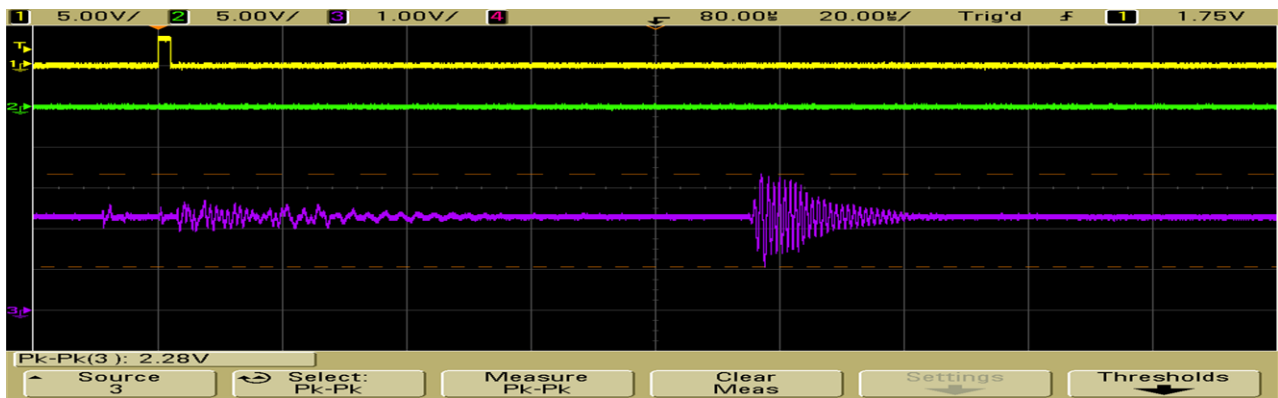

Figure 19. Excitation Pulses vs. Echo Amplitude for 15mm Transducer

Table 3. Excitation Pulses vs. Echo Amplitude for 15mm Transducer

Number of Pulses	Echo (V)
1	2.0
2	2.28

3.3.12 The Effect of Voltage Excitation vs. Echo Amplitude

The slides that follow show the resultant echo with the 10mm transducer while increasing the excitation voltage to 30V using the TIDA00322 TI design PCB. The TIDA00322 is functionally equivalent to TDC1000-C2000 EVM used up to this point excepting it has a 30V boost supply and circuitry to voltage level shift the TDC1000 5V excitation up to 30V. The transducer performance was measured at 20cm (maximum) water level.

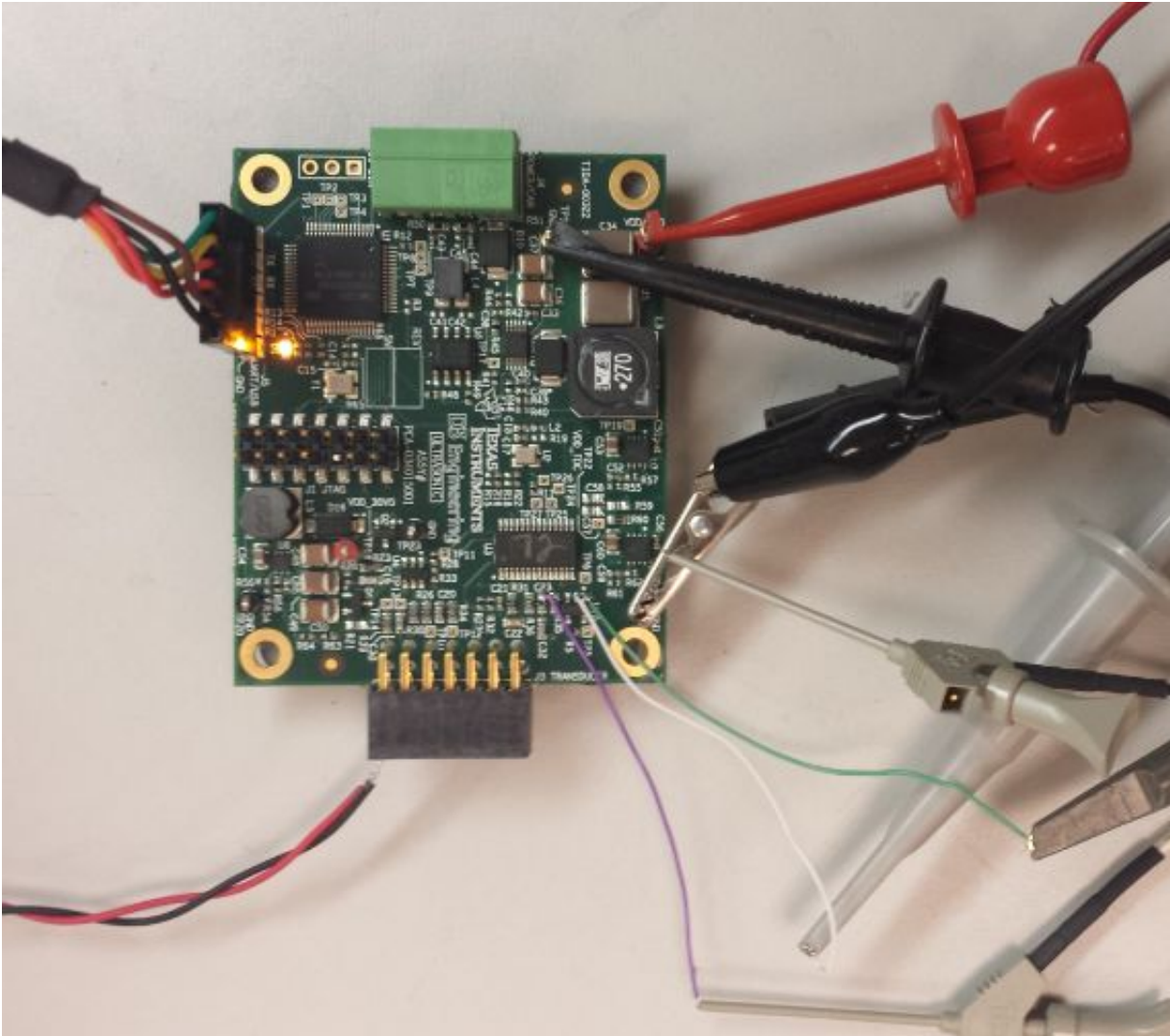

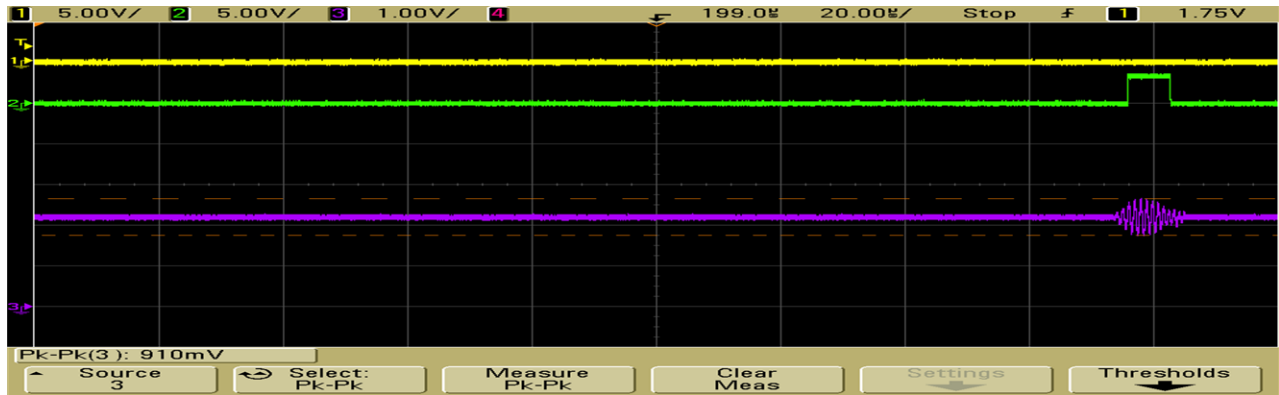

Figure 20. 5V Drive at 20cm Water Height

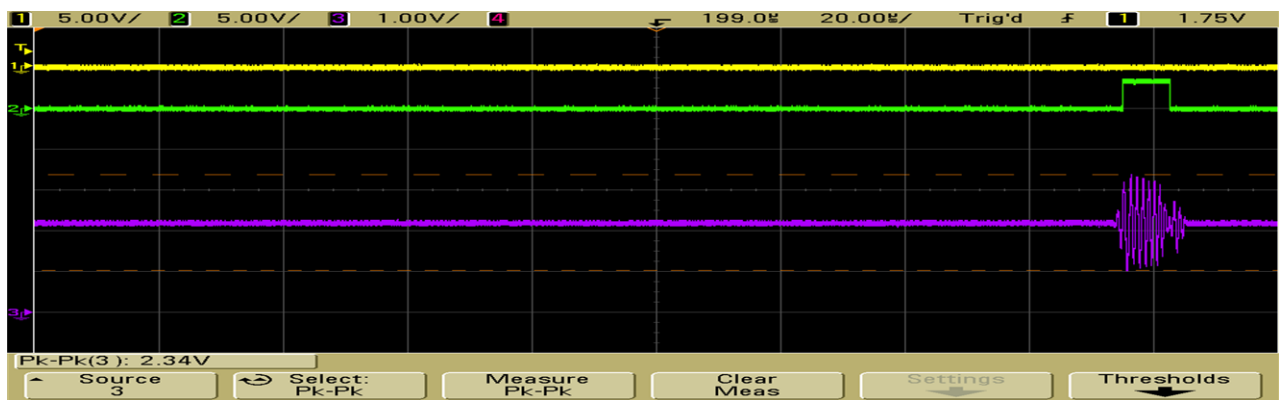

Figure 21. 30V Drive 20cm Water Height

Table 4. Excitation Pulses Voltage vs. Echo Amplitude for 10mm Transducer at 20cm

Excitation Voltage (V)	Echo (V)
5	.910
30	2.34

Why use higher voltage excitation? This question is best illustrated in the 7mm transducer example below. The question becomes why add the cost and complexity of a boost DC-DC and level shift circuit if a user could just increase the gain of the receive chain.

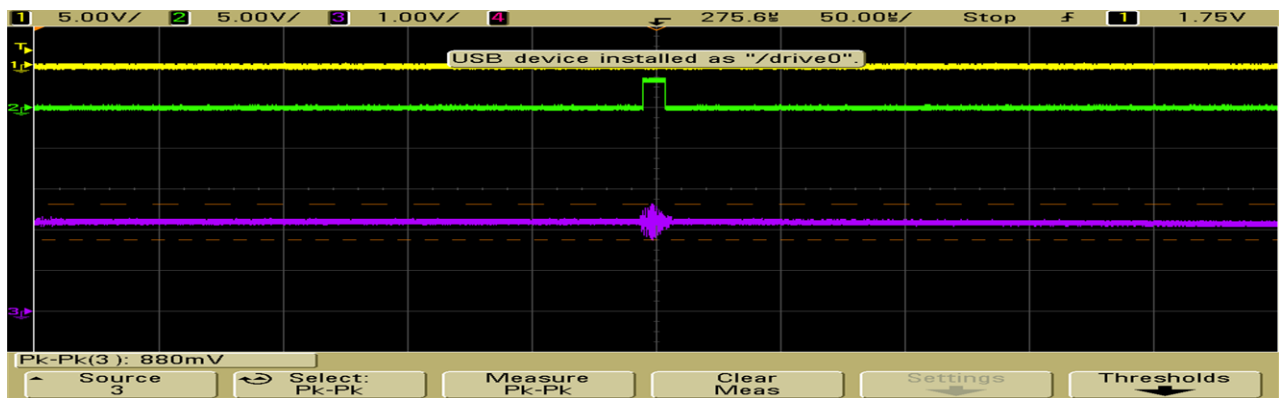

Figure 22. 7mm Transducer at 20cm Water Height at 9db Gain with 30V Excitation: Echo Amplitude: 0.81V

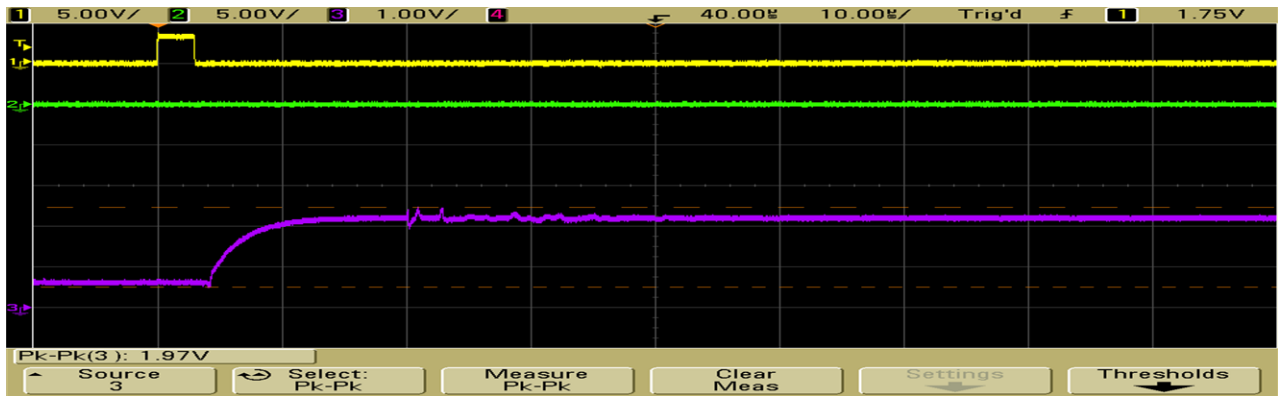

Figure 23. Ringdown Amplitude: $\sim .25V$ at 9db Gain with 30V Excitation

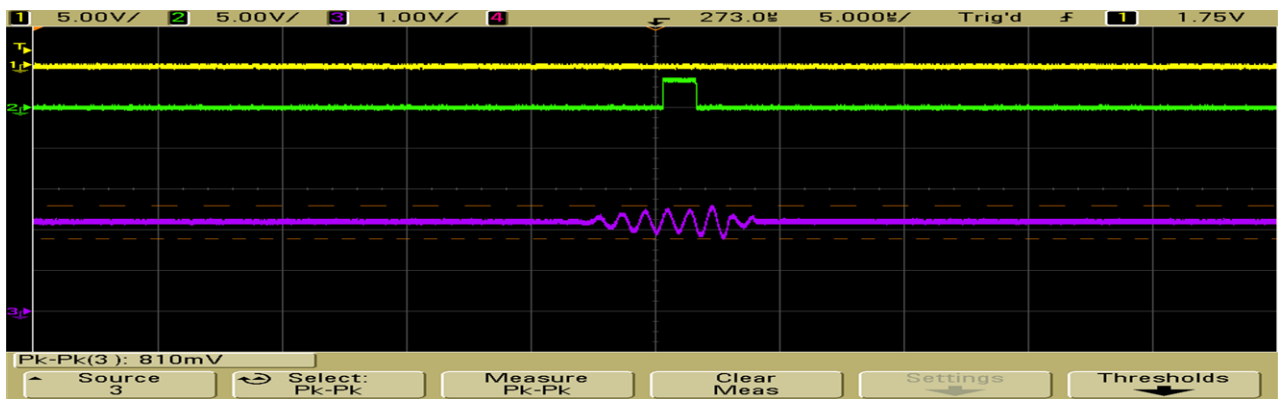

Figure 24. 7mm Transducer at 20cm Water Height at 21db Gain with 5V Excitation: Echo Amplitude

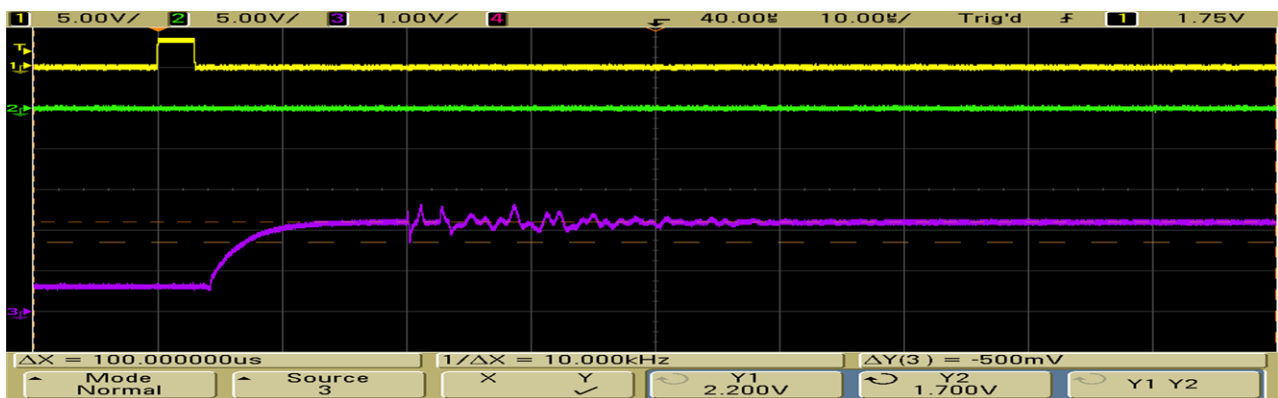

Figure 25. Ringdown Amplitude: $\sim 1.0V$ at 21db Gain with 5V Excitation

Results: If low fluid level ($<35\mu s$) is required then high voltage excitation will be required. Otherwise the user can maximize the TDC1000 gain and use blanking to filter out the ringdown echoes.

3.3.13 Final System Configuration

After all of the analysis of the different size transducers and different excitation voltages, what are the best choices of transducers and register configuration for the original system requirement?

1. ShortTOF or not? Due to the 2cm low level requirement this isn't required. So non-ShortTOF is best.
2. Transducer size? 10mm will be chosen for cost considerations.
3. High voltage or not? At 20cm only the 10mm and 15mm transducers were capable of creating a large enough echo with a minimum of ringdown so the low level requirement could be met. In either case the high voltage wasn't required. However, in some circumstances where the container is in motion (automotive etc.) the high voltage can guarantee a return echo in the presence of surface perturbations as the echoes may be reduced in amplitude and how frequently they can be observed. The 10mm is cheaper than the 15mm so it was selected.
4. Register Configuration: See [Figure 26](#):

The following are the results for the 10mm transducer at 20cm (15db, Vthreshld 410, autozero 8us, 5V excitation)

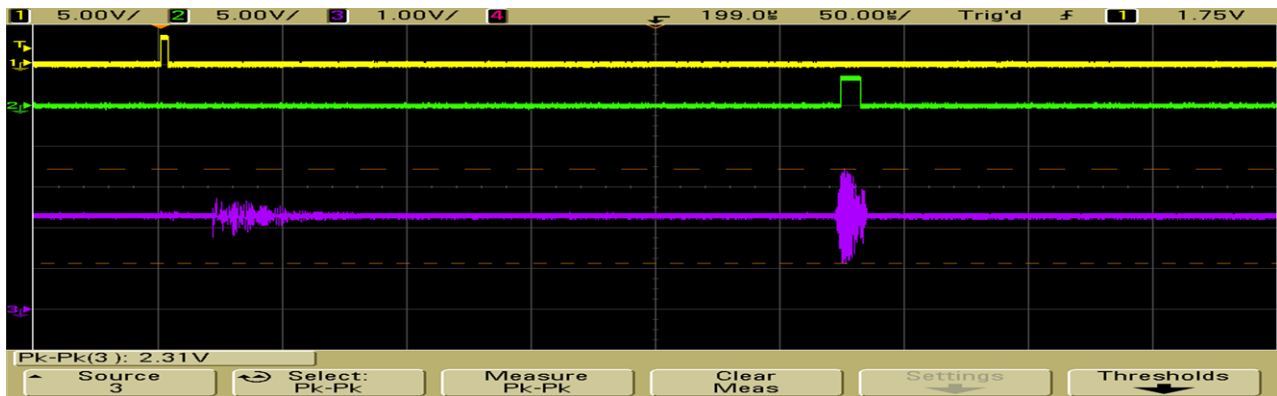

And at 2cm Level (15db, Vthreshld 410, autozero 8us, 5V excitation)

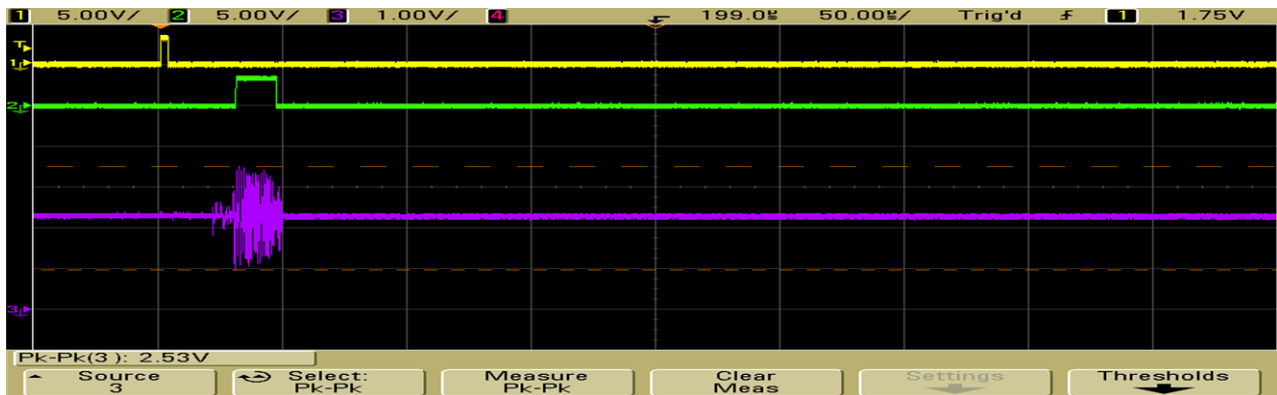

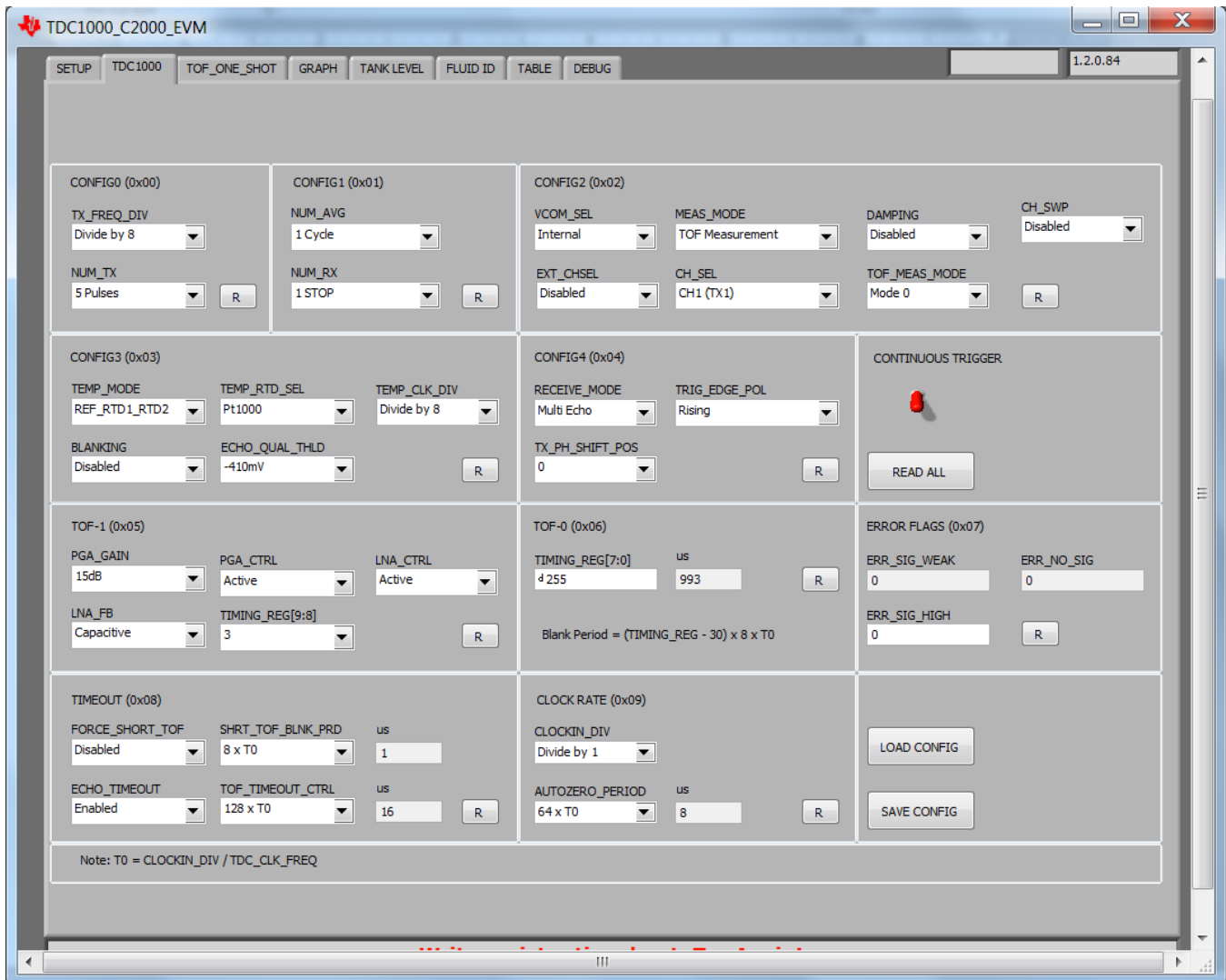

Figure 26. Final Register Settings

3.3.14 Tank Features

There are several factors in tank construction that can affect level measurements. The single best physical advantage to increase distance (level) measurement and reduce measurement filtering is using a level waveguide. A level waveguide is a vertical tube within the tank with multiple inlets that allow the fluid level in it to be the same as in the main tank. Using a waveguide aids level measurements by increasing level height measurement capability for a given electronic system as it increases the signal to noise ratio for the transducer. It does this by reducing the amount of signal loss due to the transducer beam spreading. In essence it confines the acoustic beam so less signal is lost due to transducer beam spreading and aids measurements by acting as a physical low pass filter for surface perturbations. Lastly, the waveguide helps reduce echo signal loss due to container tilting. If a container is not kept level, the surface is no longer parallel to the tank bottom, which translates into less efficient signal transmission back to the transducer.

4 Conclusion

Given a specific set of system requirements the TDC1000 can enable a variety of solutions for any given level measurement problem due to its high level of programmability. We have demonstrated in this application note how to measure level of liquid in a specific container. The TDC1000's high degree of programmability enables the systems designer to build a sub-mm accurate, non-invasive, level sensing solution that is both flexible and low cost. Ultrasonic level measurement has the added advantage to operating through conductive (metallic) tanks.

5 Tools and Resources

Further information:

- TDC1000-TDC7200 EVM (<http://www.ti.com/tool/tdc1000-tdc7200evm>)
- TDC1000-C2000 EVM (<http://www.ti.com/tool/tdc1000-c2000evm>)
- Automotive Ultrasonic Fluid Level/Quality Measurement Reference Design TIDA-00322 (<http://www.ti.com/tool/TIDA-00322>)
- Application Note: How to Select and Mount Transducers in Ultrasonic Sensing for Level Sensing and Fluid ID (<http://www.ti.com/lit/an/snaa266/snaa266.pdf>)
- Application Note: Ultrasonic Sensing for Fluid Identification and Contamination (<http://www.ti.com/lit/pdf/snaa265.pdf>)
- Videos and other information (<http://www.ti.com/ultrasonic>)

Revision History

DATE	REVISION	NOTES
July 2015	*	Initial release.

IMPORTANT NOTICE

Texas Instruments Incorporated and its subsidiaries (TI) reserve the right to make corrections, enhancements, improvements and other changes to its semiconductor products and services per JESD46, latest issue, and to discontinue any product or service per JESD48, latest issue. Buyers should obtain the latest relevant information before placing orders and should verify that such information is current and complete. All semiconductor products (also referred to herein as "components") are sold subject to TI's terms and conditions of sale supplied at the time of order acknowledgment.

TI warrants performance of its components to the specifications applicable at the time of sale, in accordance with the warranty in TI's terms and conditions of sale of semiconductor products. Testing and other quality control techniques are used to the extent TI deems necessary to support this warranty. Except where mandated by applicable law, testing of all parameters of each component is not necessarily performed.

TI assumes no liability for applications assistance or the design of Buyers' products. Buyers are responsible for their products and applications using TI components. To minimize the risks associated with Buyers' products and applications, Buyers should provide adequate design and operating safeguards.

TI does not warrant or represent that any license, either express or implied, is granted under any patent right, copyright, mask work right, or other intellectual property right relating to any combination, machine, or process in which TI components or services are used. Information published by TI regarding third-party products or services does not constitute a license to use such products or services or a warranty or endorsement thereof. Use of such information may require a license from a third party under the patents or other intellectual property of the third party, or a license from TI under the patents or other intellectual property of TI.

Reproduction of significant portions of TI information in TI data books or data sheets is permissible only if reproduction is without alteration and is accompanied by all associated warranties, conditions, limitations, and notices. TI is not responsible or liable for such altered documentation. Information of third parties may be subject to additional restrictions.

Resale of TI components or services with statements different from or beyond the parameters stated by TI for that component or service voids all express and any implied warranties for the associated TI component or service and is an unfair and deceptive business practice. TI is not responsible or liable for any such statements.

Buyer acknowledges and agrees that it is solely responsible for compliance with all legal, regulatory and safety-related requirements concerning its products, and any use of TI components in its applications, notwithstanding any applications-related information or support that may be provided by TI. Buyer represents and agrees that it has all the necessary expertise to create and implement safeguards which anticipate dangerous consequences of failures, monitor failures and their consequences, lessen the likelihood of failures that might cause harm and take appropriate remedial actions. Buyer will fully indemnify TI and its representatives against any damages arising out of the use of any TI components in safety-critical applications.

In some cases, TI components may be promoted specifically to facilitate safety-related applications. With such components, TI's goal is to help enable customers to design and create their own end-product solutions that meet applicable functional safety standards and requirements. Nonetheless, such components are subject to these terms.

No TI components are authorized for use in FDA Class III (or similar life-critical medical equipment) unless authorized officers of the parties have executed a special agreement specifically governing such use.

Only those TI components which TI has specifically designated as military grade or "enhanced plastic" are designed and intended for use in military/aerospace applications or environments. Buyer acknowledges and agrees that any military or aerospace use of TI components which have **not** been so designated is solely at the Buyer's risk, and that Buyer is solely responsible for compliance with all legal and regulatory requirements in connection with such use.

TI has specifically designated certain components as meeting ISO/TS16949 requirements, mainly for automotive use. In any case of use of non-designated products, TI will not be responsible for any failure to meet ISO/TS16949.

Products

Audio	www.ti.com/audio
Amplifiers	amplifier.ti.com
Data Converters	dataconverter.ti.com
DLP® Products	www.dlp.com
DSP	dsp.ti.com
Clocks and Timers	www.ti.com/clocks
Interface	interface.ti.com
Logic	logic.ti.com
Power Mgmt	power.ti.com
Microcontrollers	microcontroller.ti.com
RFID	www.ti-rfid.com
OMAP Applications Processors	www.ti.com/omap
Wireless Connectivity	www.ti.com/wirelessconnectivity

Applications

Automotive and Transportation	www.ti.com/automotive
Communications and Telecom	www.ti.com/communications
Computers and Peripherals	www.ti.com/computers
Consumer Electronics	www.ti.com/consumer-apps
Energy and Lighting	www.ti.com/energy
Industrial	www.ti.com/industrial
Medical	www.ti.com/medical
Security	www.ti.com/security
Space, Avionics and Defense	www.ti.com/space-avionics-defense
Video and Imaging	www.ti.com/video

TI E2E Community

e2e.ti.com