

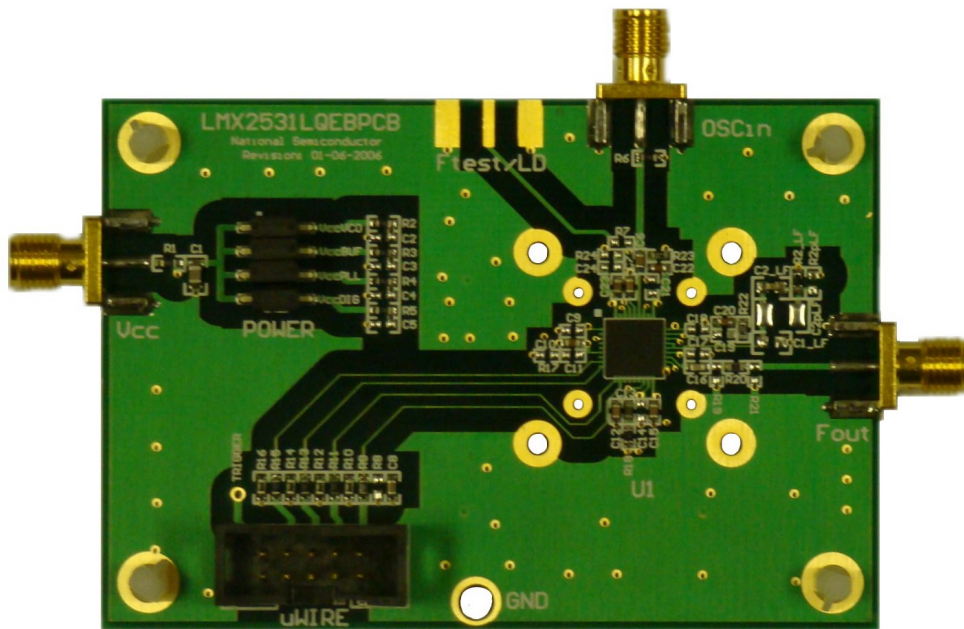

LMX2531LQ1226E

Evaluation Board Operating Instructions



National Semiconductor Corporation
Timing Devices Business Group

10333 North Meridian
Suite 400
Indianapolis, IN 46290

LMX2531LQ1226EFPEB Rev 3.31.2008

Table of Contents

TABLE OF CONTENTS	2
LOOP FILTER	3
QUICK SETUP	3
TROUBLESHOOTING	4
PHASE NOISE	5
FREE-RUNNING VCO PHASE NOISE (INTERNAL DIVIDE BY 2 DISABLED)	6
FREE-RUNNING VCO PHASE NOISE (INTERNAL DIVIDE BY 2 ENABLED)	7
FRACTIONAL SPURS (INTERNAL DIVIDE BY 2 DISABLED)	8
FRACTIONAL SPURS (INTERNAL DIVIDE BY 2 ENABLED)	9
INTEGER SPURS (INTERNAL DIVIDE BY 2 DISABLED)	10
INTEGER SPURS (INTERNAL DIVIDE BY 2 ENABLED)	11
CODELOADER SETTINGS	12
SCHEMATIC	17
BILL OF MATERIALS	18
TOP LAYER	19
MID LAYER 1 "GROUND PLANE"	20
MID LAYER 2 "POWER"	21
BOTTOM LAYER "SIGNAL"	22
TOP BUILD DIAGRAM	23

Loop Filter

Loop Bandwidth	8.0 kHz	Kϕ	1440 μ A (16X)
Phase Margin	61.3 deg	F_{comp}	10 MHz
Crystal Frequency	10 MHz	Output Frequency	1184 – 1268 MHz (DIV2=0) 592 - 634 MHz (DIV2=1)
Supply Voltage	3.0 Volts	VCO Gain	3 - 6 MHz/Volt

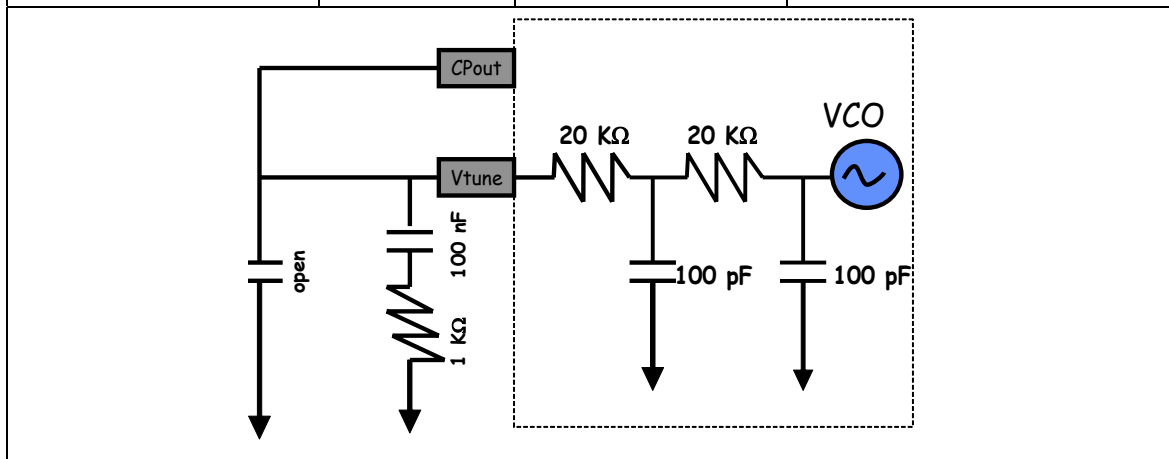

Quick Setup

- Install the CodeLoader software which is available at www.national.com/timing.
- Attach the parallel , or USB to parallel, port cable to the computer and the evaluation board.
- Connect 3.0 volts to the **Vcc** connector
- Connect the **Fout** connector to a spectrum analyzer or phase noise analyzer
- Connect a clean 10 MHz source to the **OSCin** pin. Typically, the 10 MHz output from the back of the RF test equipment is a good source. Signal generators tend to be very noisy and should be used with caution. If a signal generator is used, the signal generator phase noise contribution can be reduced by setting the signal to 80 MHz and dividing this down to a phase detector frequency of 10 MHz.
- Set up the CodeLoader software
 - Select the proper part from the menu as Select Part->PLL+VCO->LMX2531LQ1226E
 - Select the proper mode from the Mode menu
 - Load the part by pressing Ctrl+L or selecting Keyboard Controls->Load Device from the menu
- It is recommended to ensure proper communication with the device
 - Click the REG_RST bit on the bits/pins page and observe the current go to 0 mA
 - Unclick the REG_RST bit AND press Ctrl+L. The current should be approximately 35 mA
 - If device does not respond to this, consult the troubleshooting section
- When using the lower frequency band with divide by 2 enabled (DIV2=1), be aware that the frequency programmed to the VCO is actually twice the output frequency of the device because the VCO frequency is being divided by 2.

Troubleshooting

Problem	Corrective Actions
Software does not communicate with the evaluation boards	<p>All Modes</p> <ul style="list-style-type: none"> • Ensure a valid signal is presented to the OSCin connector. If a signal generator is used, ensure the RF is ON. • Consult the CodeLoader instructions for more detailed information on communication issues <p>LPT Mode (Uses Parallel Port Cable)</p> <ul style="list-style-type: none"> • Ensure that CodeLoader is selected to LPT mode on the Port Setup tab • Ensure the proper port number is selected (LPT1, LPT2, LPT3). CodeLoader does NOT automatically detect this. • Ensure the LPT cable is securely connected to the computer and board. • Exit and Restart CodeLoader • Ensure the parallel port is in the correct mode <ul style="list-style-type: none"> ○ Windows often requires Administrative access to write to the parallel port ○ Ensure that the parallel port is set to “Enabled” in windows device manager ○ A reboot upon installation of CodeLoader is sometimes necessary to get the parallel port to work. ○ Standard mode is the most reliable. This can be set in the BIOS mode of the computer as “Normal”, “Output Only”, or “AT” <p>USB Mode (Uses USB to Parallel Port Converter)</p> <ul style="list-style-type: none"> • On the menu, select USB->Version to verify communication with the board • Ensure the Green LEDs are lit on the USB board • Ensure there are no conflicts with other USB devices and reinstall the board
Part responds to programming, but does not lock to the correct frequency	<ul style="list-style-type: none"> • Ensure that there is a valid signal presented to the OSCin connector. If a signal generator is used, ensure that the RF is set to ON. • If using the lower frequency band (DIV2=1), understand that the VCO frequency in CodeLoader should be twice the frequency at the Fout pin. • Ensure that the VCO FREQUENCY CAL bits on the Bits/Pins tab are correct • Ensure that the loop filter is optimized if the charge pump current, phase detector frequency, or loop filter values have been changed from their original settings. Ensure that the integrated loop filter components on CodeLoader are set to their proper settings
Close-in phase noise is worse than evaluation board instructions show	<ul style="list-style-type: none"> • Ensure the signal presented to OSCin connector is clean. Try another source, or if it is a signal generator, try using a higher frequency and dividing it down to the phase detector frequency. • Ensure the OSCin signal and cable provide sufficient power level. • If the phase detector frequency or charge pump current are lowered from their original settings, the in-band phase noise can be degraded, even if the loop filter is re-designed for the same loop bandwidth. If the loop bandwidth is decreased, in-band phase noise can be degraded
Far-out phase noise is worse than evaluation board instructions show	<ul style="list-style-type: none"> • Ensure the measurement equipment noise floor is not limiting the measurement. For spectrum analyzers, the noise floor at a particular setting can be measured by removing the RF input signal • If the settings are changed from what the board was designed for, ensure the delta-sigma modulator is not increasing the far-out noise. To know this, tune to an integer channel and set the ORDER bit to “Reset Modulator”. The far out phase noise should not decrease. If it does, try a loop filter with more attenuation or select a lower order delta-sigma modulator.

Phase Noise

Output Frequency = 1226 MHz
Internal Divide by 2 Disabled (DIV2=0)

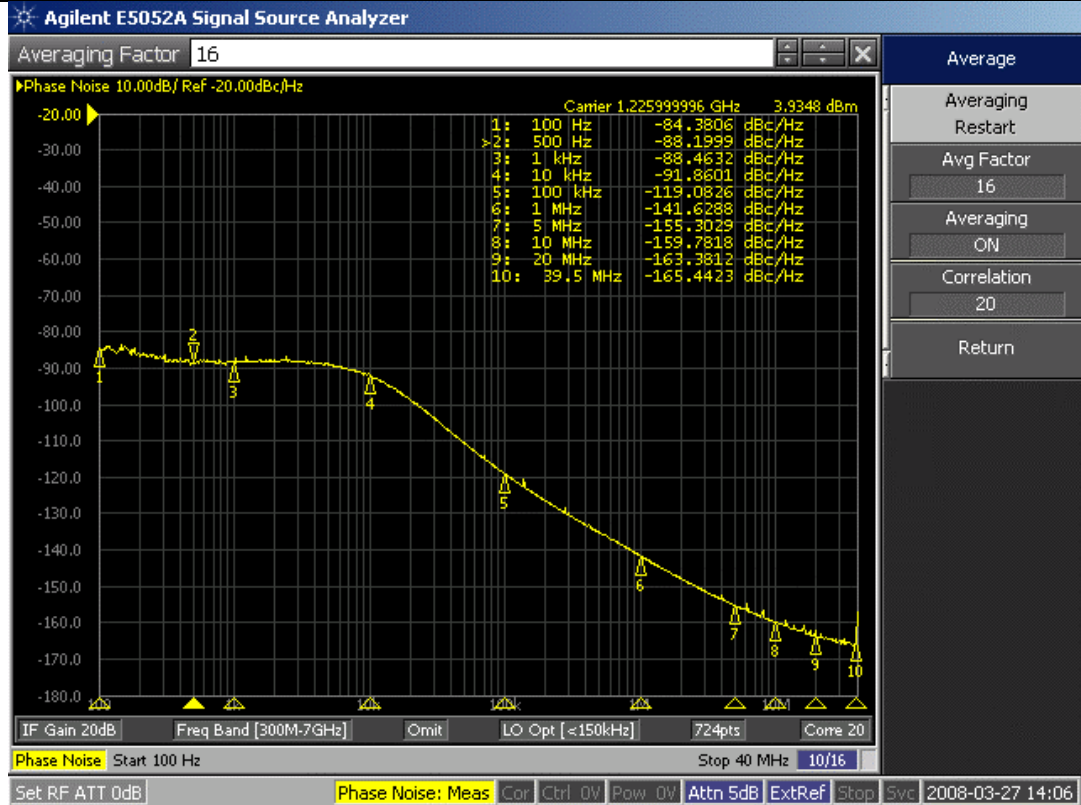

Output Frequency = 613 MHz
Internal Divide by 2 Enabled (DIV2=1)

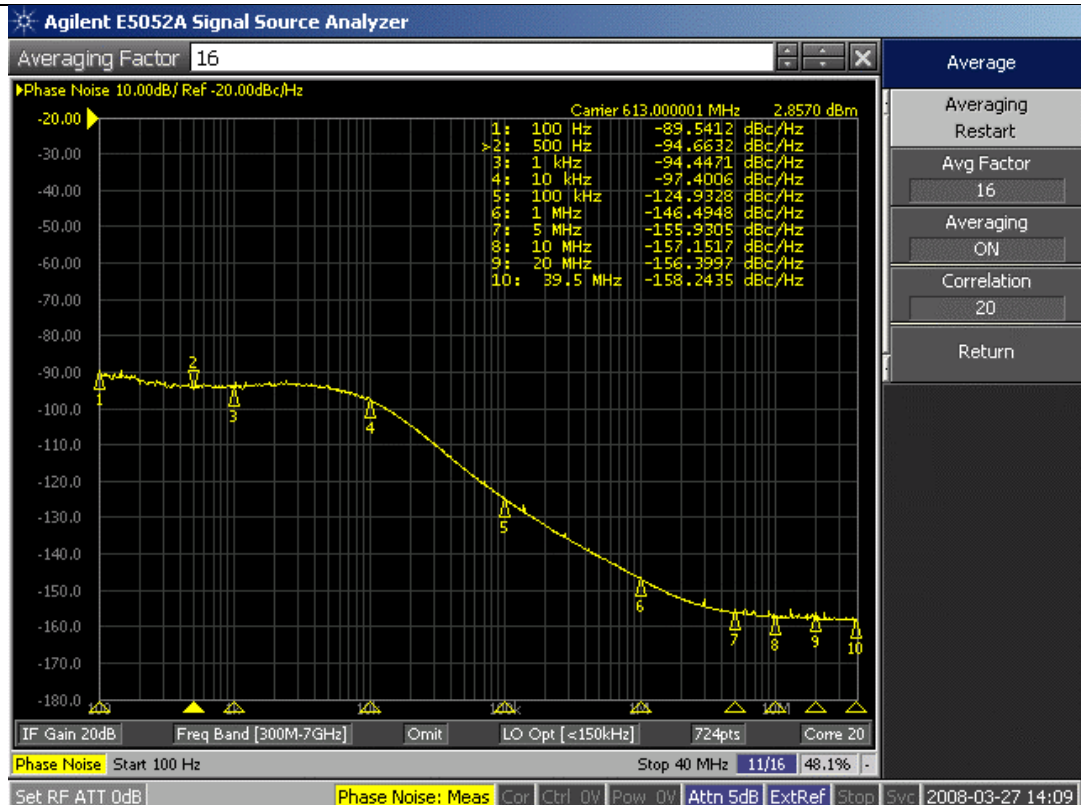

Free-Running VCO Phase Noise (Internal Divide by 2 Disabled)

Fout = 1184 MHz

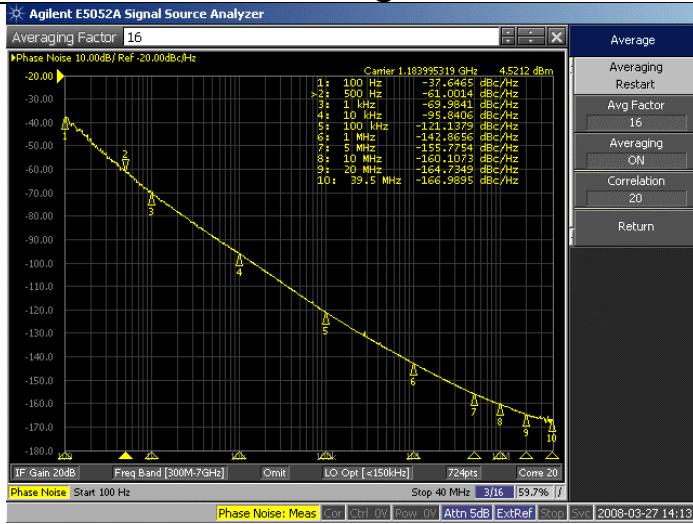

Fout = 1226 MHz

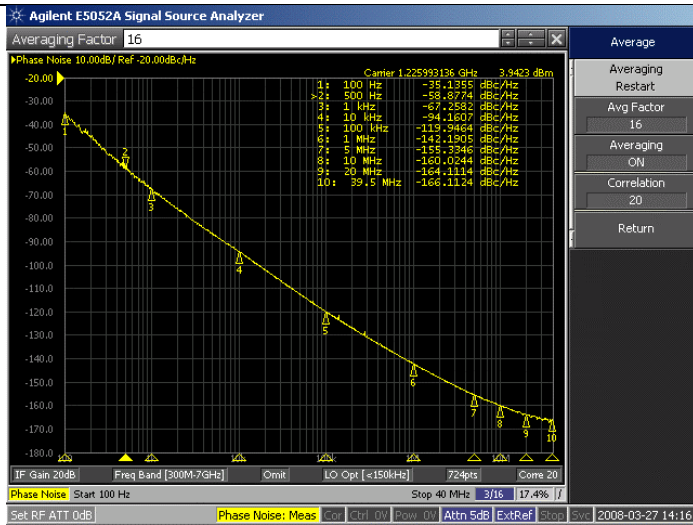

Fout = 1268 MHz

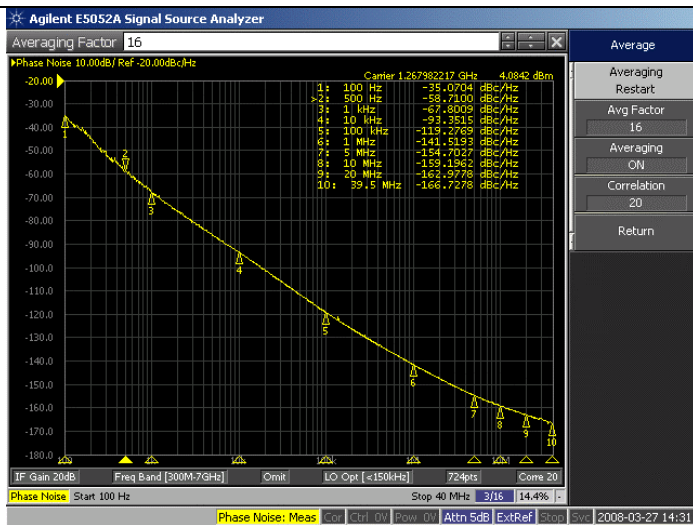

The plots to the left show the true phase noise capability of the VCO. In order to take these plots, the E5052 phase noise analyzer was used. The method was to lock the PLL to the proper frequency, then disable the EN_PLL, EN_PLLLDO1, and EN_PLLLDO2 bits. The equipment needs to be able to track the VCO phase noise to measure in this way, and one can not let the VCO drift too far off in frequency. If this kind of equipment is not available, the VCO phase noise can also be measured by making a very narrow loop bandwidth filter.

Free-Running VCO Phase Noise (Internal Divide by 2 Enabled)

Fout = 592 MHz (1184 MHz/2)

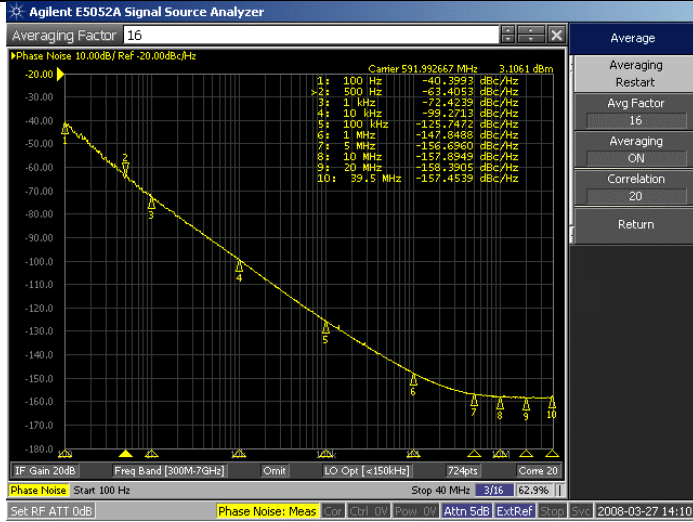

Fout = 613 MHz (1226 MHz/2)

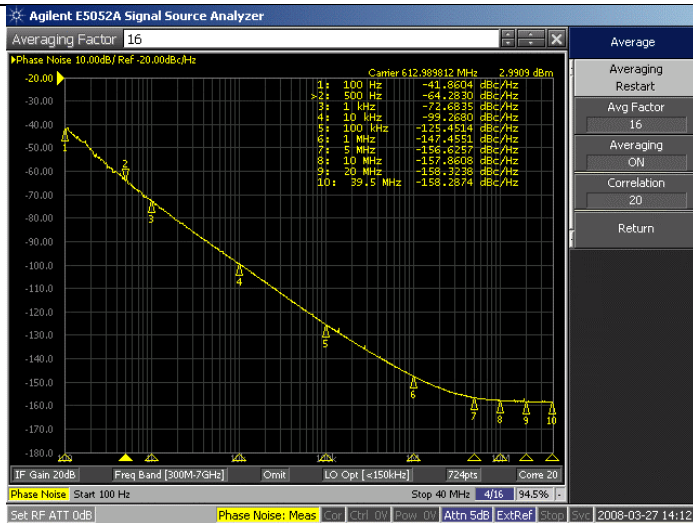

Fout = 634 MHz (1268 MHz/2)

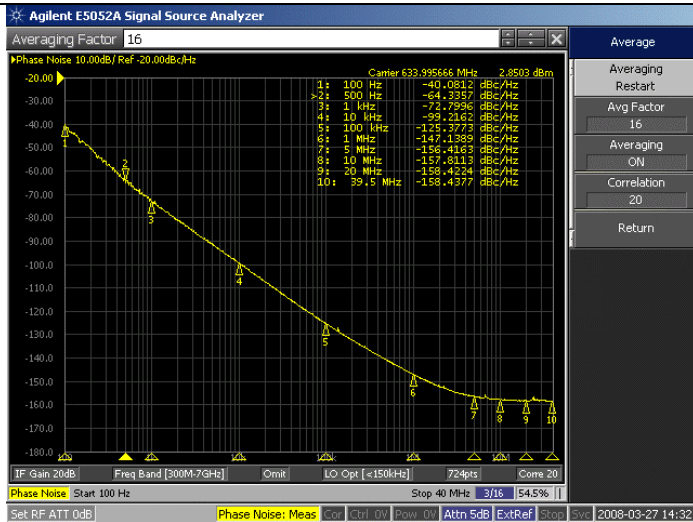

The plots to the left show the true phase noise capability of the VCO. In order to take these plots, the E5052 phase noise analyzer was used. The method was to lock the PLL to the proper frequency, then disable the EN_PLL, EN_PLLLDO1, and EN_PLLLDO2 bits. The equipment needs to be able to track the VCO phase noise to measure in this way, and one can not let the VCO drift too far off in frequency. If this kind of equipment is not available, the VCO phase noise can also be measured by making a very narrow loop bandwidth filter.

When divide by 2 is enabled, the phase noise at lower offsets is about 6 dB better; but at high offsets, the phase noise improvement may be less because the divider noise floor is adding to the phase noise.

Fractional Spurs (Internal Divide by 2 Disabled)

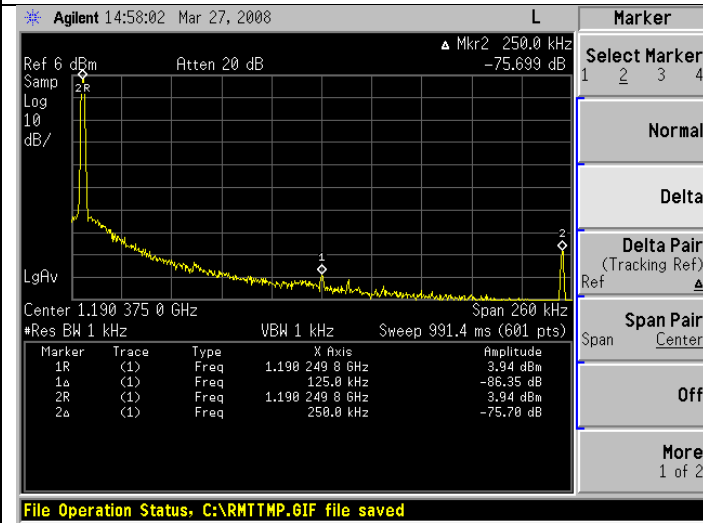

Fractional Spur at 250 kHz offset at a worst case frequency of 1190.25 MHz is -75.7 dBc. Worst case channels occur at exactly one channel spacing above or below a multiple of the crystal frequency. The sub-fractional spur at 125 kHz offset of -86.4 dBc is also visible.

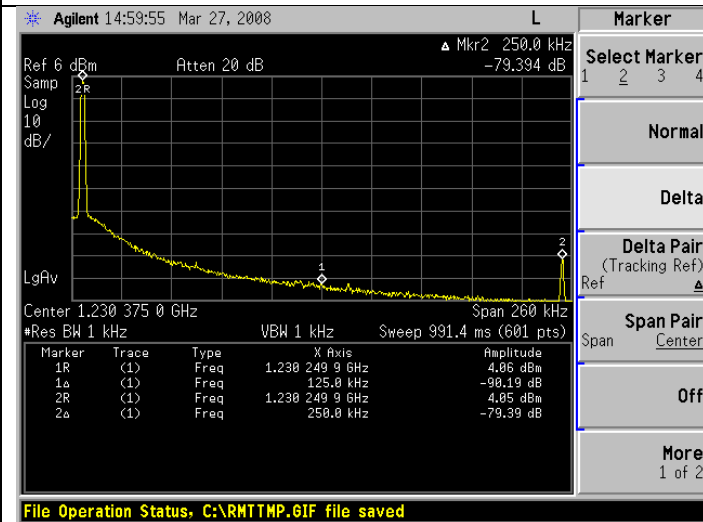

Fractional Spur at 250 kHz offset at a worst case frequency of 1230.25 MHz is -79.4 dBc.

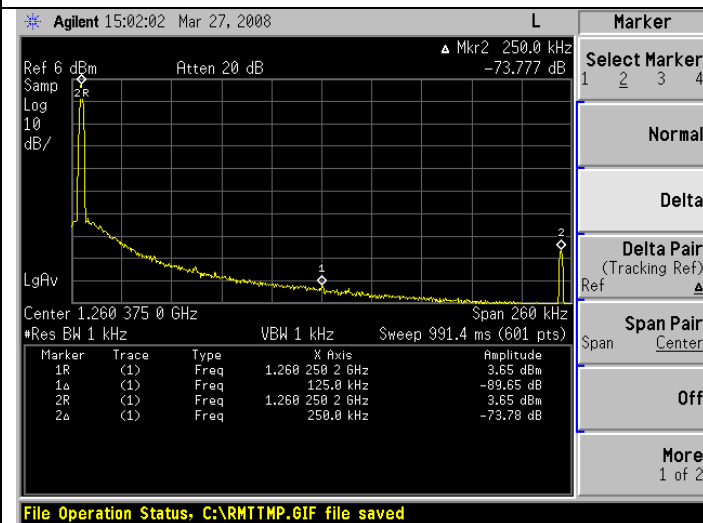

Fractional Spur at 250 kHz offset at a worst case frequency of 1260.25 MHz is -73.8 dBc.

Fractional Spurs (Internal Divide by 2 Enabled)

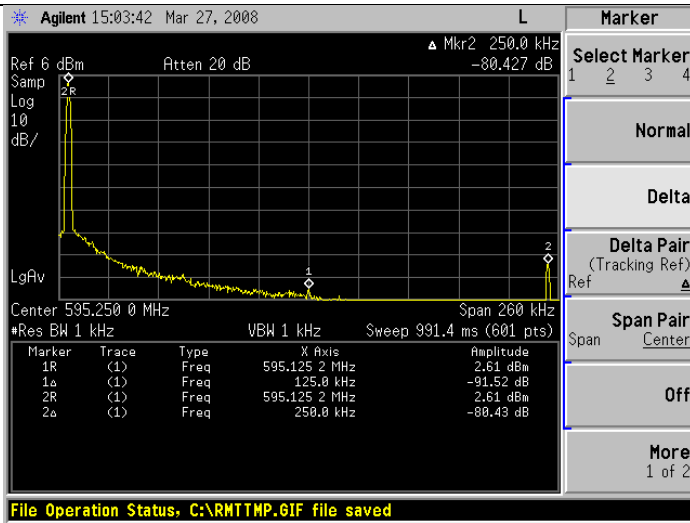

Spur at 250 kHz offset at a frequency of 595.125 MHz is -80.4 dBc. Since this mode uses the divide by 2 mode, the channel spacing here is actually 125 kHz. The spur at 125 kHz could be eliminated by doubling the channel spacing before the divider.

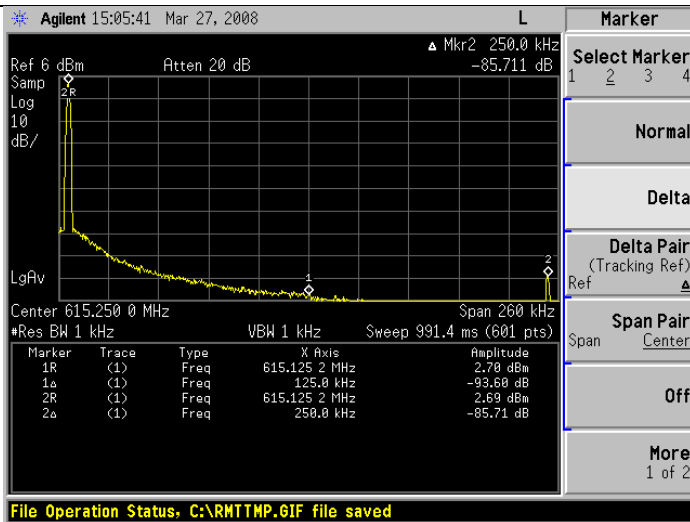

Spur at 250 kHz offset for a frequency of 615.125 MHz is -85.7 dBc.

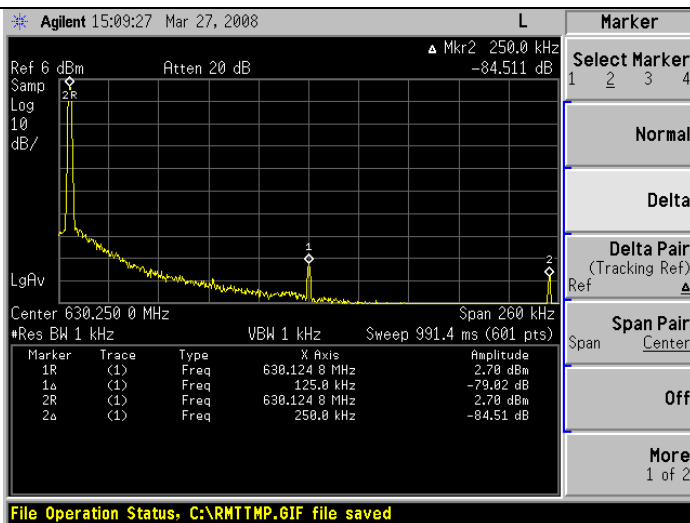

Spur at 250 kHz offset for a frequency of 630.125 MHz is -84.5 dBc. The sub-fractional spur at 125 kHz offset of -79 dBc is also visible.

Integer Spurs (Internal Divide by 2 Disabled)

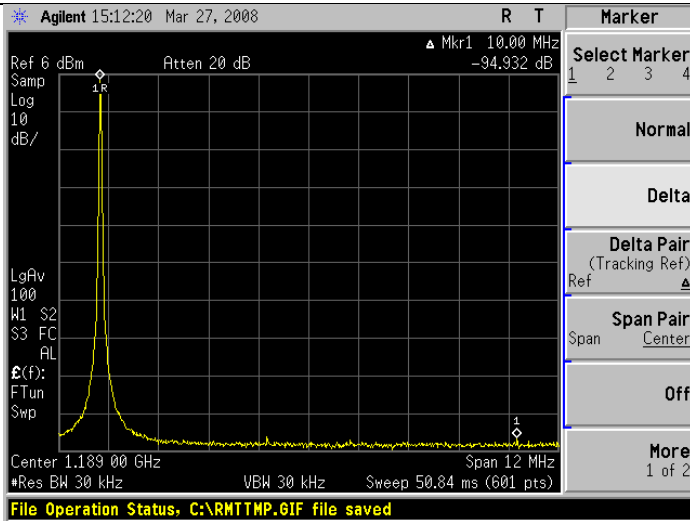

Spur at 10 MHz offset for a frequency of 1184 MHz is below the spectrum analyzer noise floor.

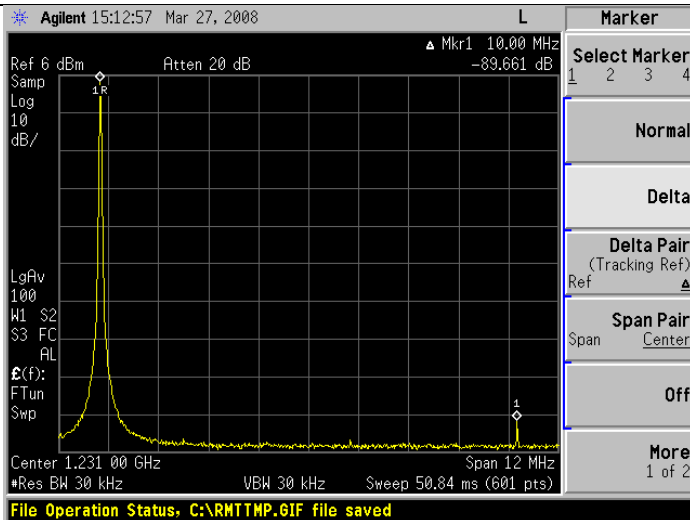

Spur at 10 MHz offset for a frequency of 1226 MHz is -89.7 dBc.

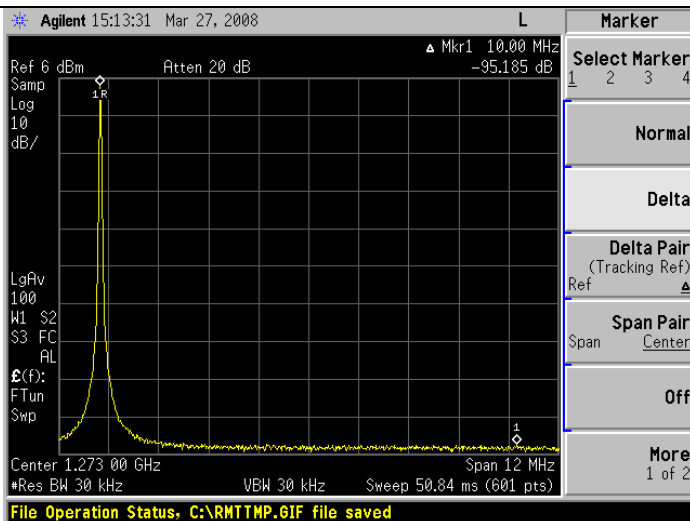

Spur at 10 MHz offset for a frequency of 1268 MHz is below the spectrum analyzer noise floor.

Integer Spurs (Internal Divide by 2 Enabled)

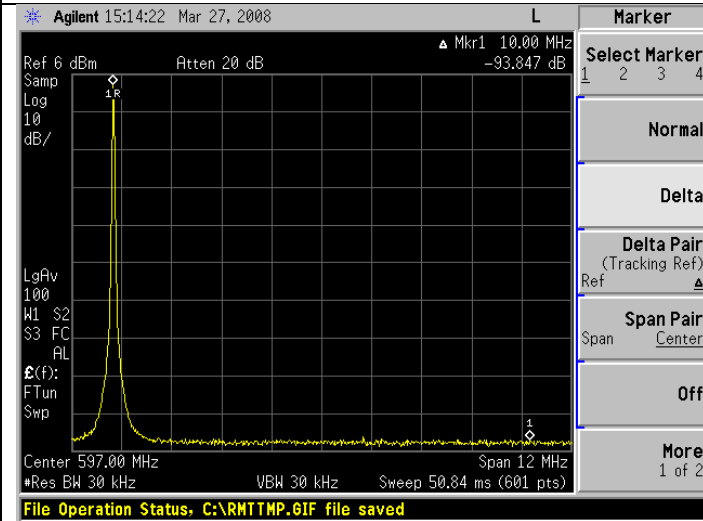

Spur at 10 MHz offset for a frequency of 592 MHz is below the spectrum analyzer noise floor.

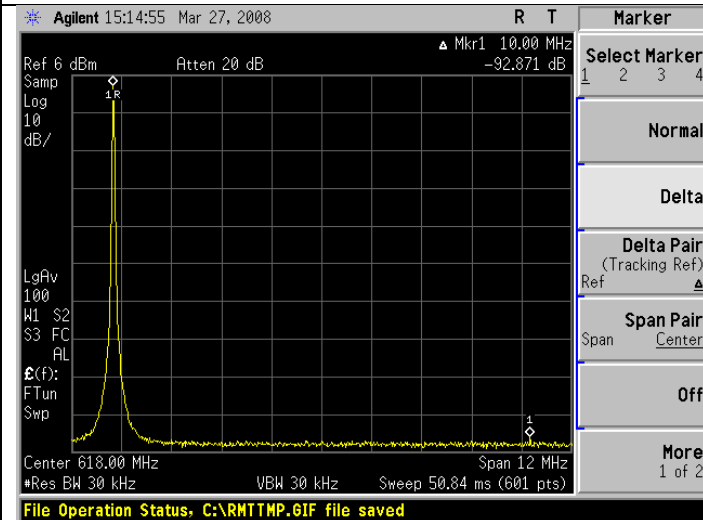

Spur at 10 MHz offset for a frequency of 613 MHz is better than -92.9 dBc, although it could be much better than this since this measurement is so close to the spectrum analyzer noise floor.

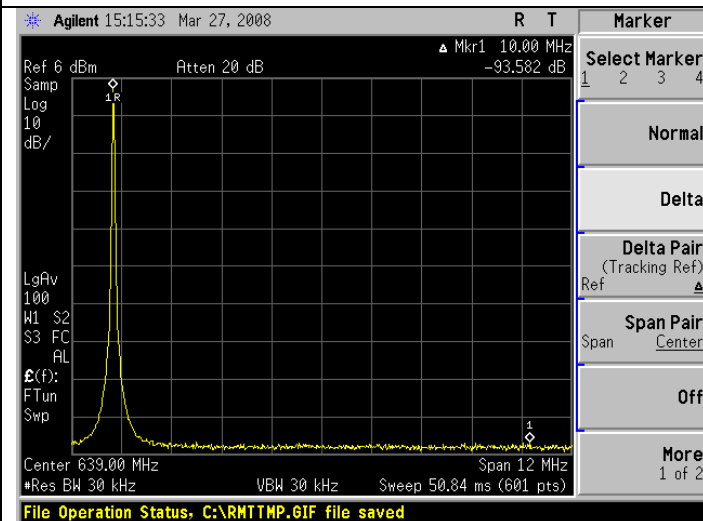

Spur at 10 MHz offset for a frequency of 634 MHz is below the spectrum analyzer noise floor.

CodeLoader Settings

CodeLoader runs many devices. When CodeLoader is first started, it is necessary to select the correct device.

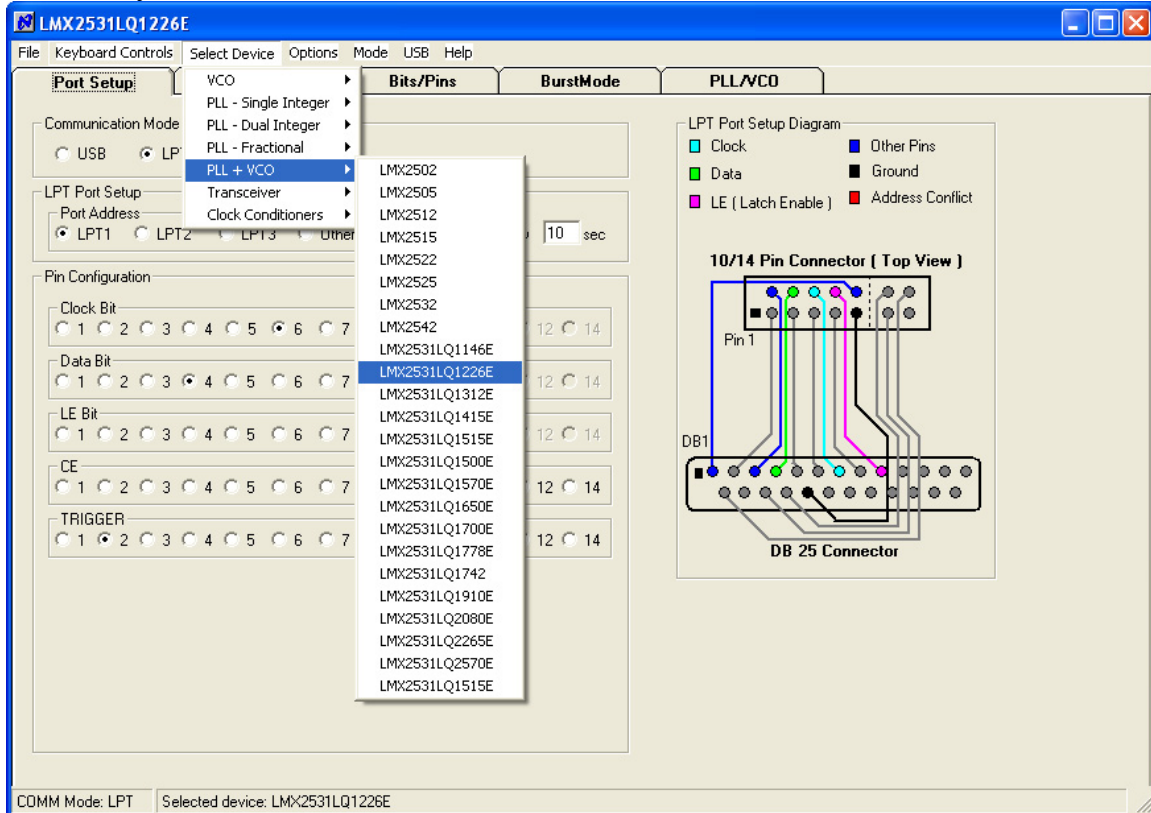

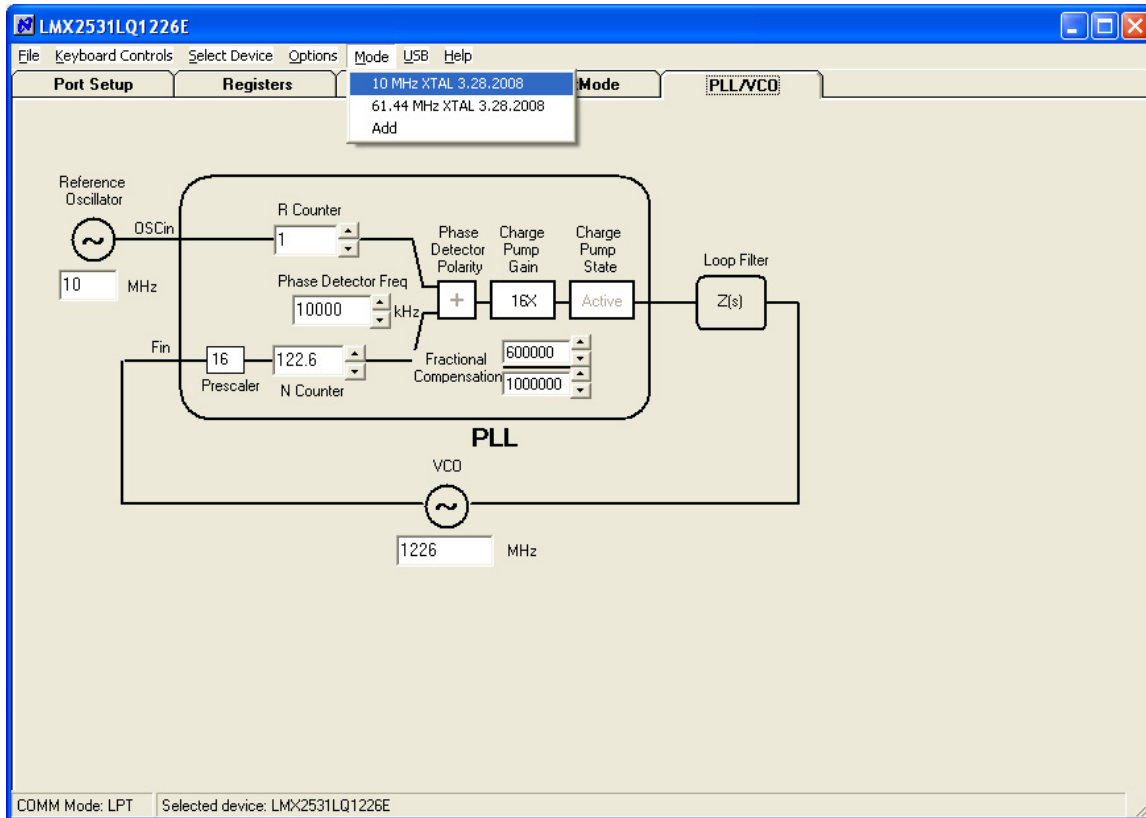

There can be different modes defined for a particular part. A mode can be recalled easily from the menu. This restores bit settings and frequencies, but not the Port Setup information. For the CodeLoader program, the default reference oscillator used for these instructions was 10 MHz, but there is a mode for a 61.44 MHz oscillator as well. If the bits become scrambled, their original state may be recalled by choosing the appropriate mode. If the internal divide by 2 (DIV2) is enabled, the VCO frequency still reflects the VCO frequency before the divide by 2.

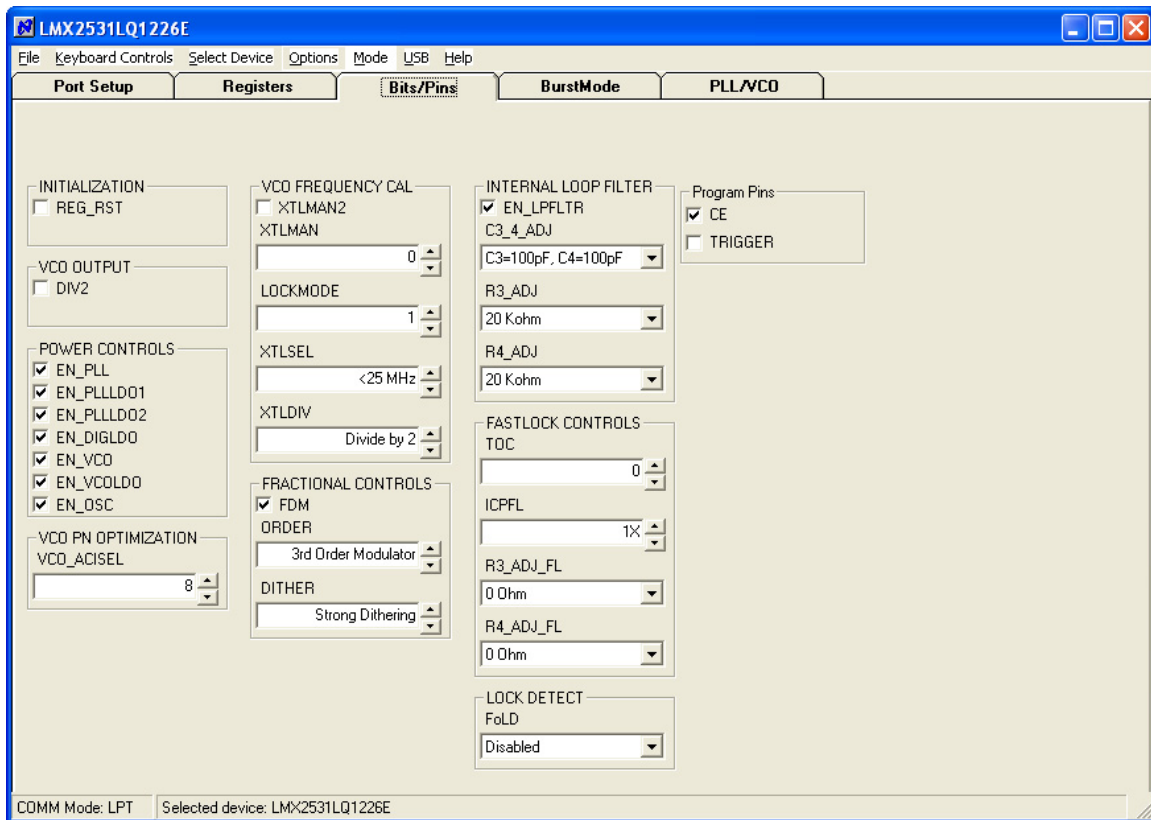

The Bits/Pins tab displays many of the bits used to program the part. Right mouse click any bit to view more information about what this does.

When the DIV2 bit is enabled, the frequency from the part will be half of that shown on the PLL/VCO tab. The frequency on the PLL/VCO tab does not reflect this because the divide by 2 is actually after the VCO. Also be sure to load the device (Ctrl+L) after changing this bit to allow the VCO to calibrate for optimal phase noise performance.

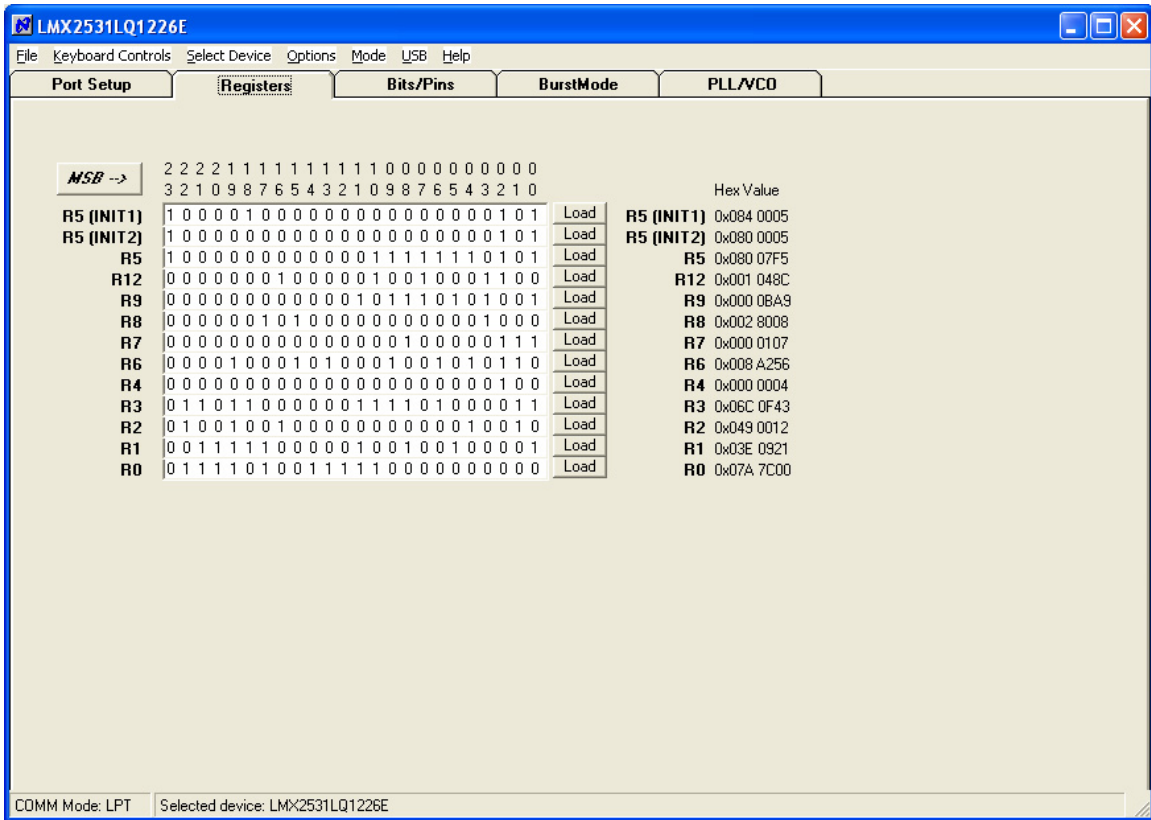

The Registers tab shows the literal bits that are being sent to the part. These are the registers every time the PLL is loaded by using the menu command or Ctrl+L. R5 (INIT1) and R5 (INIT 2) are just the R5 register being used to properly initialize the part. So a single CNT+L will load the part.

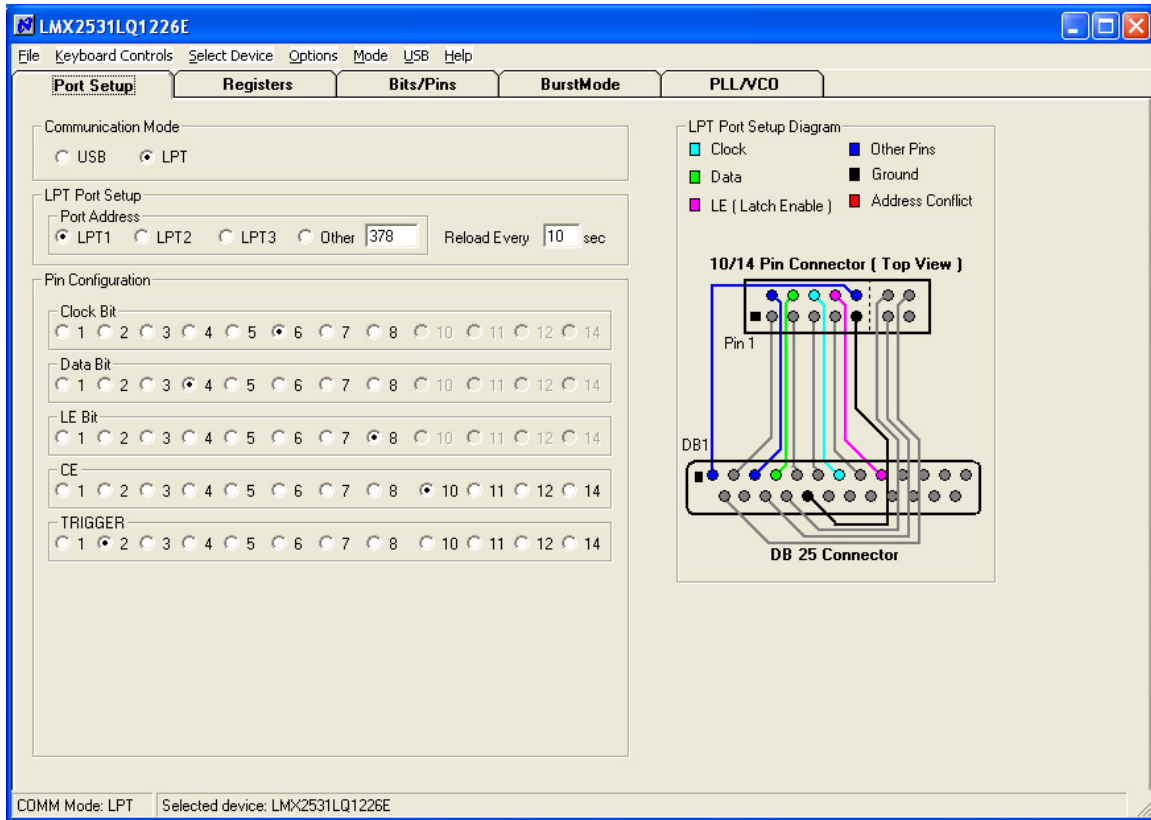

The port setup tells CodeLoader what information goes where. If this is wrong, the part will not program. Although LPT1 is usually correct, CodeLoader does NOT automatically detect the correct port. On some laptops, it may be LPT3.

Schematic

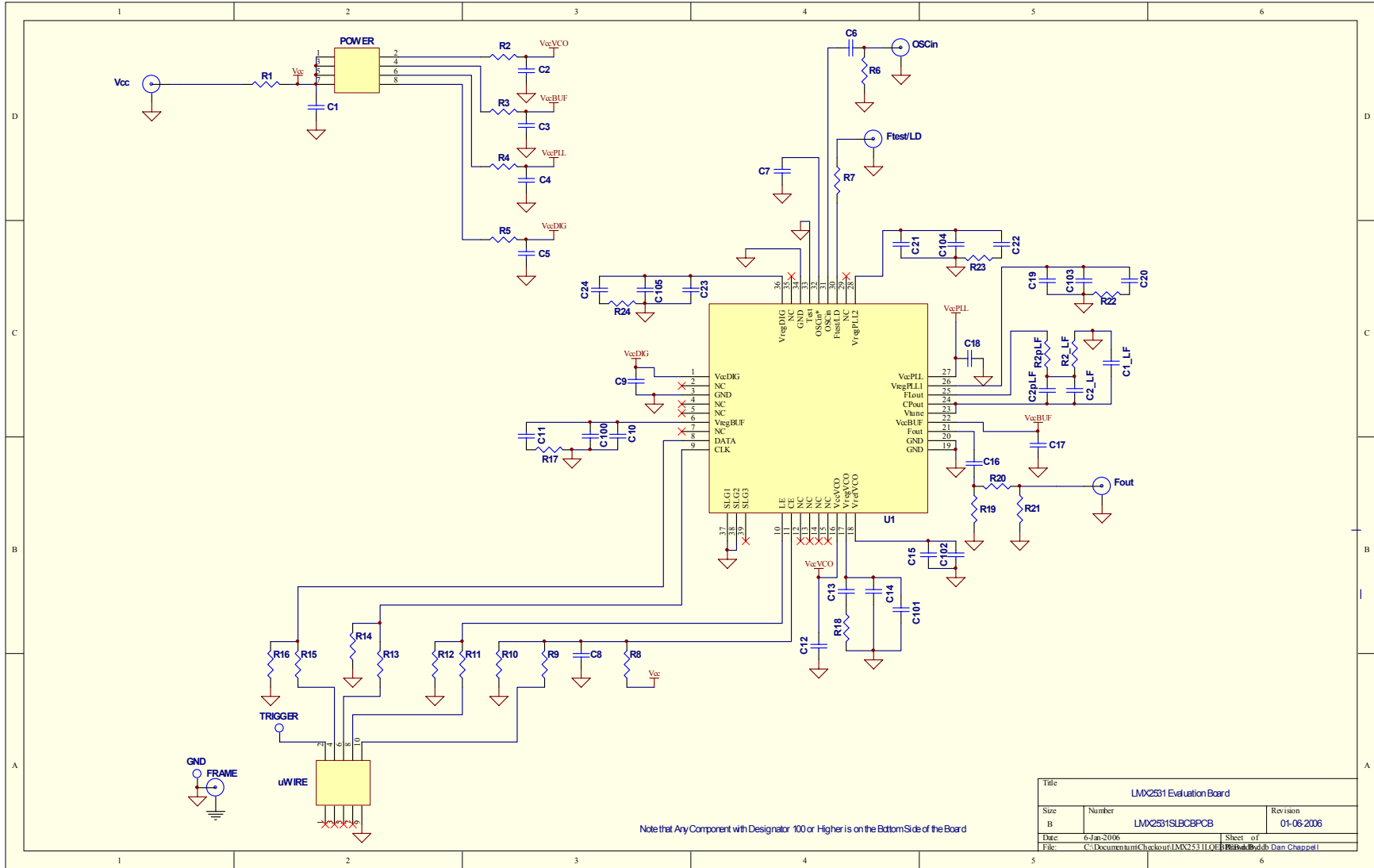

Bill of Materials

Bill of Materials				LMX2531_LF				Revision 3.28.2008	
Item	QTY	Manufacturer	Part #	Size	Tol	Voltage	Material	Value	Designators
0	20	n/a						Open Capacitors	C1_LF, C2pLF, C2, C3, C4, C5, C9, C11, C14, C17, C18, C19, C21, C24, C100, C101, C102, C103, C104, C105
	7							Open Resistors	R2pLF,R7, R8, R17, R19, R21, R24
	1							Open Miscellaneous	Ftest/LD
1	1	Kemet	C0603C101J5GAC	603	5%	50V	C0G	100pF	C16
2	2	Kemet	C0603C103J5RAC	603	5%	50V	X7R	10nF	C10, C23
3	1	Kemet	C0805C104K5RACTU	805	5%	25V	C0G	100nF	C2_LF
4	6	Kemet	C0603C104J3RAC	603	5%	25V	X7R	100nF	C6, C7, C12, C15, C22, C20
5	1	Kemet	C0603C105K4RAC	603	10%	16V	X5R	1uF	C8
6	1	Kemet	C0603C475K9PAC	603	10%	6.3V	X5R	4.7uF	C13
7	1	Kemet	C0805C106K8PAC	805	10%	10V	X5R	10uF	C1
8	1	Vishay	CRCW0603000ZRT1	603	5%	0.1W	Thick Film	0Ω	R20
9	2	Panasonic	P.22AHCT-ND	603	10%	0.1W	Thick Film	0.22Ω	R22, R23
10	2	Vishay	CRCW06033R3JRT1	603	5%	0.1W	Thick Film	3.3Ω	R1, R18
11	4	Vishay	CRCW0603100JRT1	603	5%	0.1W	Thick Film	10Ω	R2, R3, R4, R5
12	1	Vishay	CRCW0603510JRT1	603	5%	0.1W	Thick Film	51Ω	R6
13	1	Vishay	CRCW0603102JRT1	603	5%	0.1W	Thick Film	1KΩ	R2_LF
14	4	Vishay	CRCW0603103JRT1	603	5%	0.1W	Thick Film	10KΩ	R9, R11, R13, R15
15	4	Vishay	CRCW0603123JRT1	603	5%	0.1W	Thick Film	12KΩ	R10, R12, R14, R16
16	1	Comm Con Connectors	HTSM3203-8G2	2X4	n/a	n/a	Metal/Plastic	Header	POWER
17	1	FCI Electronics	52601-S10-8	2X5	n/a	n/a	Metal/Plastic	Header	uWire
18	3	Johnson Components	142-0701-851	SMA	n/a	n/a	Metal	SMA	Fout, OSCin, Vcc
19	1	National Semiconductor	LMX2531LQEBPCB	n/a	n/a	n/a	FR4	PCB Board	n/a
							62 mil Thick	1st Layer 10 mils	
20	1	National Semiconductor	LMX2531	LLP36	n/a	2.7	Silicon	LMX2531	U1
21	4	Com Con Connectors	CCIJ255G	2-Pin	n/a	n/a	Metal/Plastic	Shunt	Place Across:
									POWER: 1-2, 3-4, 5-6, 7-8
22	4	SPC Technology	SPCS-8	0.156"	n/a	n/a	Nylon	Nylon Standoffs	Place in 4 Holes in Corners of Board

Top Layer

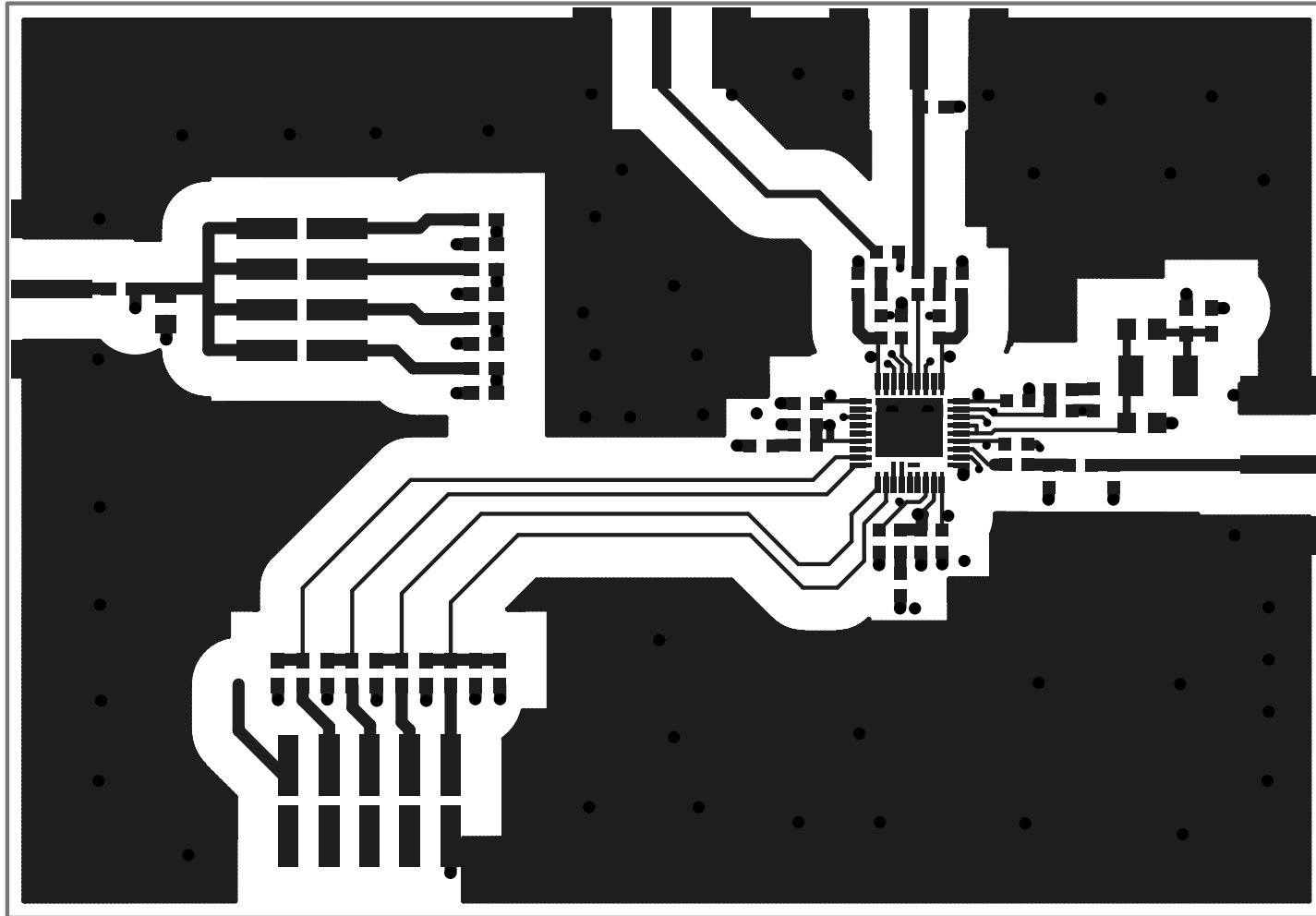

Mid Layer 1 "Ground Plane" (15 Mils Down FR4)

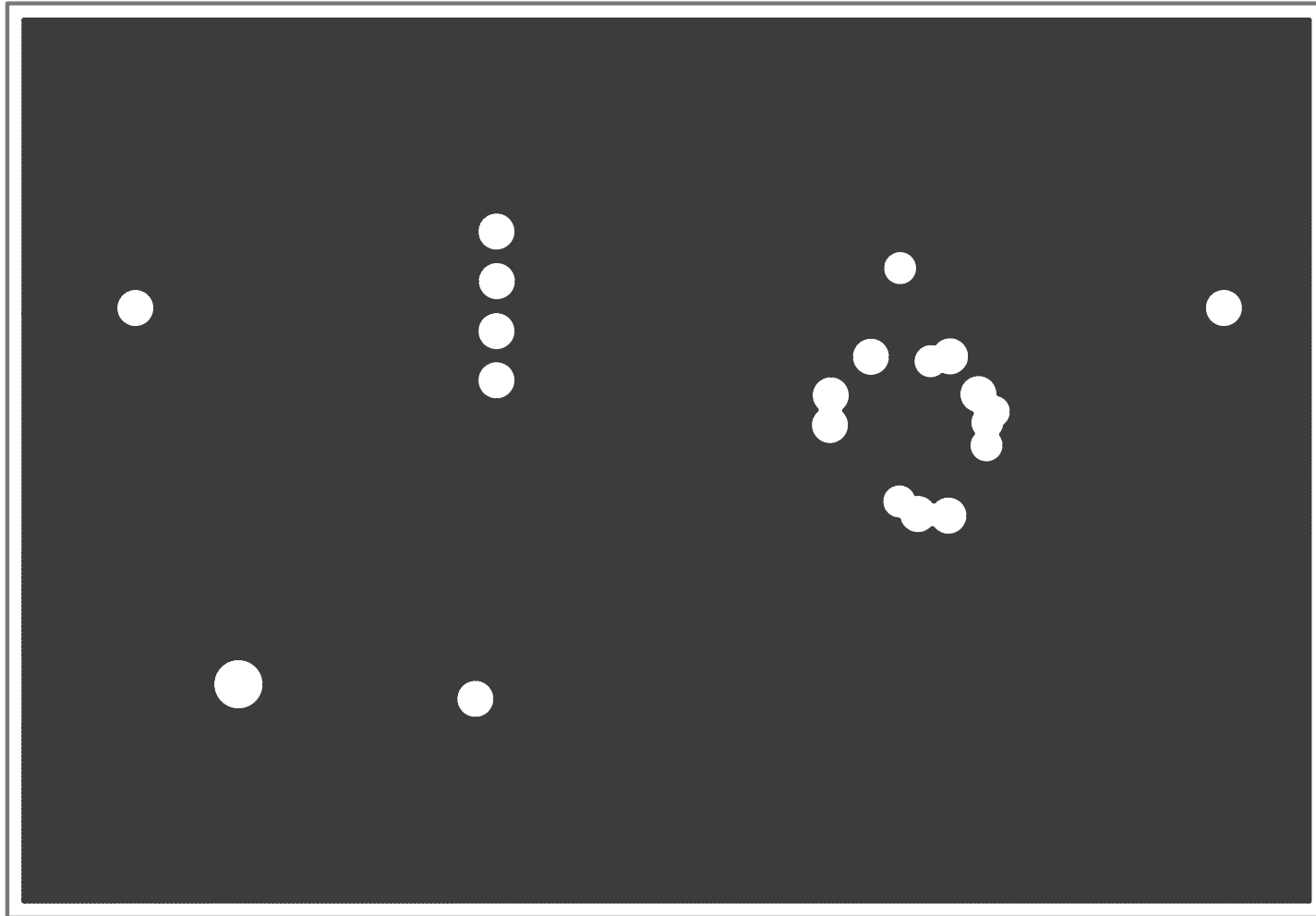

Mid Layer 2 "Power"

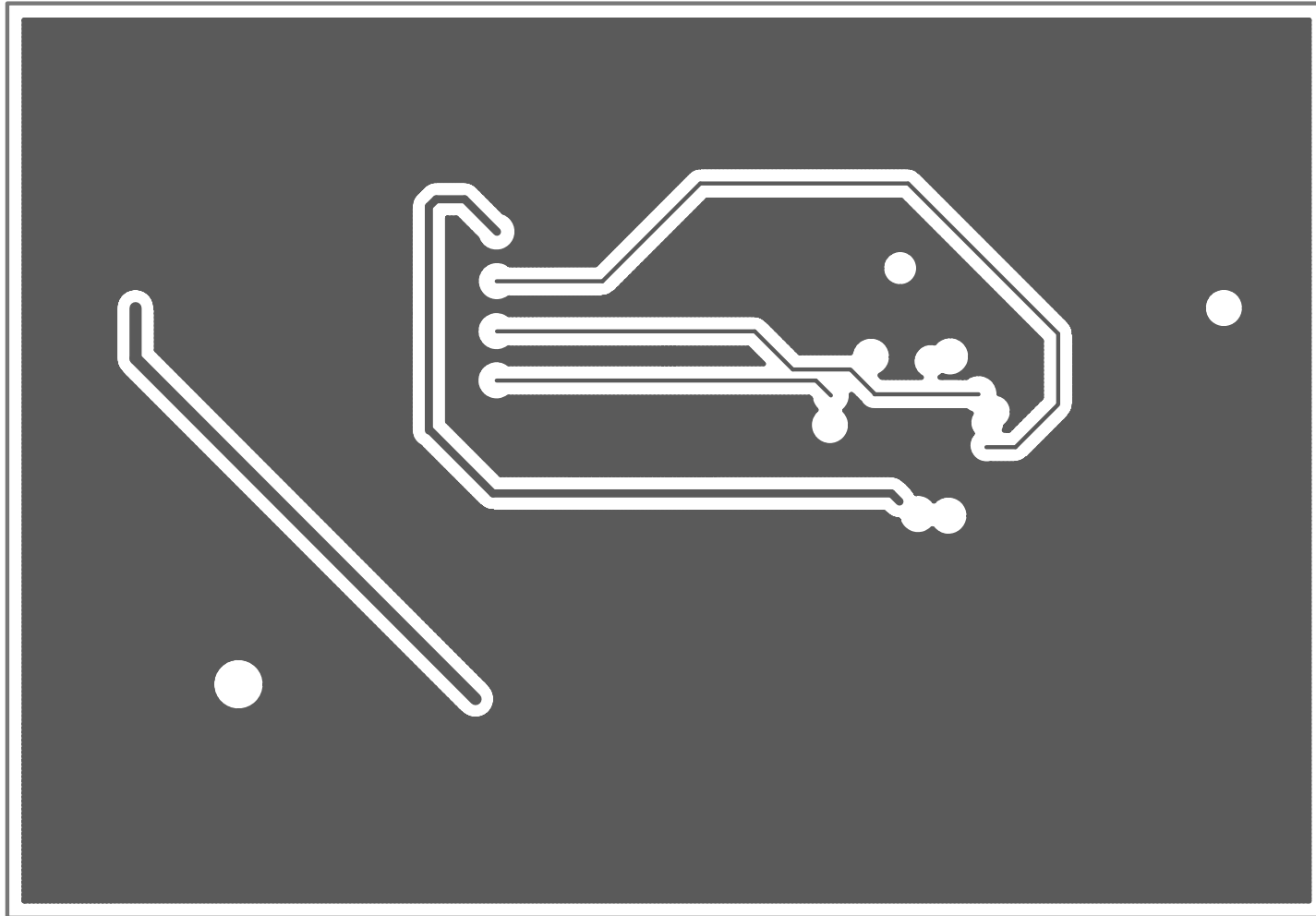

Bottom Layer "Signal"

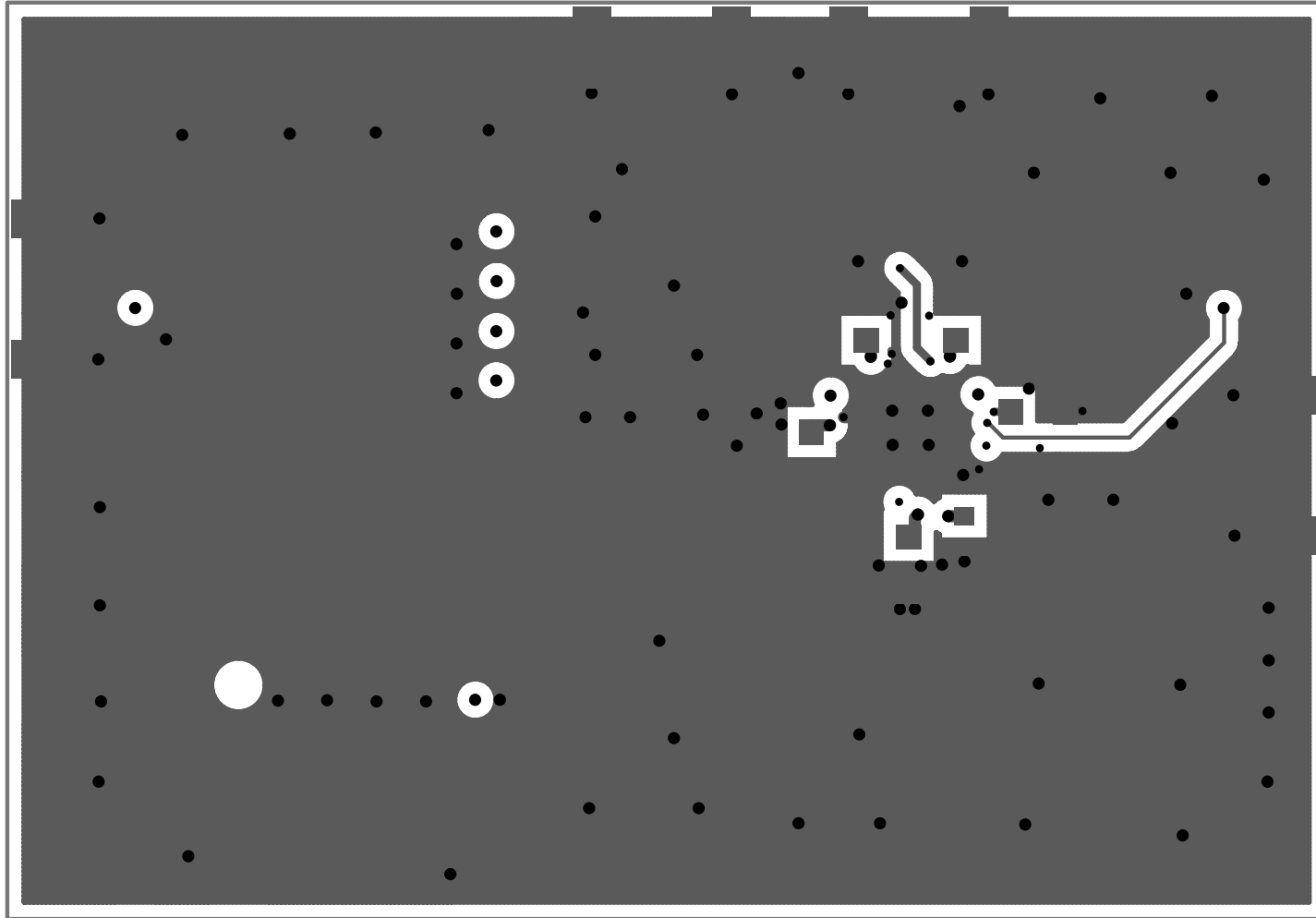

Note: Total Board Thickness = 61 mils

Top Build Diagram

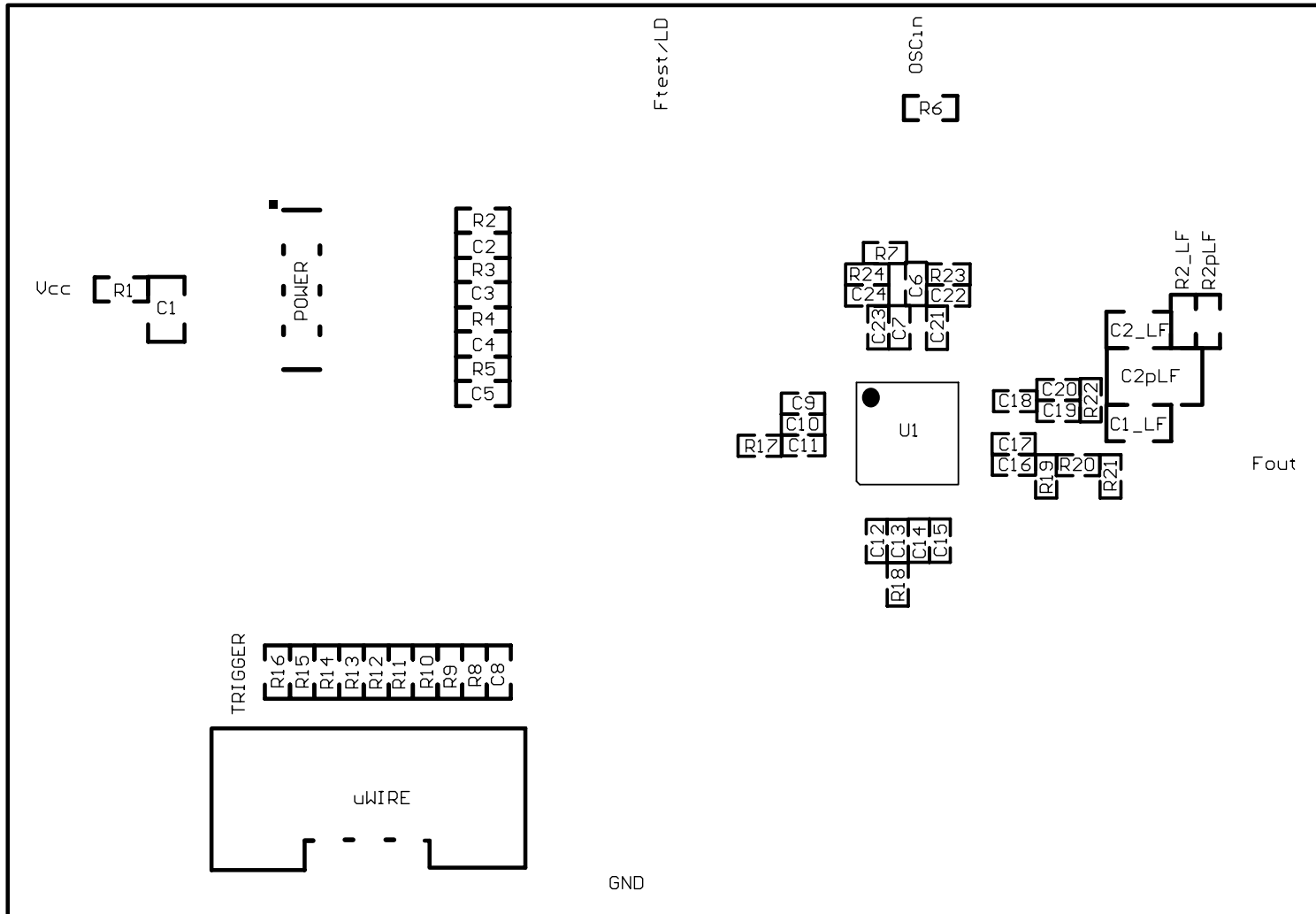

IMPORTANT NOTICE

Texas Instruments Incorporated and its subsidiaries (TI) reserve the right to make corrections, modifications, enhancements, improvements, and other changes to its products and services at any time and to discontinue any product or service without notice. Customers should obtain the latest relevant information before placing orders and should verify that such information is current and complete. All products are sold subject to TI's terms and conditions of sale supplied at the time of order acknowledgment.

TI warrants performance of its hardware products to the specifications applicable at the time of sale in accordance with TI's standard warranty. Testing and other quality control techniques are used to the extent TI deems necessary to support this warranty. Except where mandated by government requirements, testing of all parameters of each product is not necessarily performed.

TI assumes no liability for applications assistance or customer product design. Customers are responsible for their products and applications using TI components. To minimize the risks associated with customer products and applications, customers should provide adequate design and operating safeguards.

TI does not warrant or represent that any license, either express or implied, is granted under any TI patent right, copyright, mask work right, or other TI intellectual property right relating to any combination, machine, or process in which TI products or services are used. Information published by TI regarding third-party products or services does not constitute a license from TI to use such products or services or a warranty or endorsement thereof. Use of such information may require a license from a third party under the patents or other intellectual property of the third party, or a license from TI under the patents or other intellectual property of TI.

Reproduction of TI information in TI data books or data sheets is permissible only if reproduction is without alteration and is accompanied by all associated warranties, conditions, limitations, and notices. Reproduction of this information with alteration is an unfair and deceptive business practice. TI is not responsible or liable for such altered documentation. Information of third parties may be subject to additional restrictions.

Resale of TI products or services with statements different from or beyond the parameters stated by TI for that product or service voids all express and any implied warranties for the associated TI product or service and is an unfair and deceptive business practice. TI is not responsible or liable for any such statements.

TI products are not authorized for use in safety-critical applications (such as life support) where a failure of the TI product would reasonably be expected to cause severe personal injury or death, unless officers of the parties have executed an agreement specifically governing such use. Buyers represent that they have all necessary expertise in the safety and regulatory ramifications of their applications, and acknowledge and agree that they are solely responsible for all legal, regulatory and safety-related requirements concerning their products and any use of TI products in such safety-critical applications, notwithstanding any applications-related information or support that may be provided by TI. Further, Buyers must fully indemnify TI and its representatives against any damages arising out of the use of TI products in such safety-critical applications.

TI products are neither designed nor intended for use in military/aerospace applications or environments unless the TI products are specifically designated by TI as military-grade or "enhanced plastic." Only products designated by TI as military-grade meet military specifications. Buyers acknowledge and agree that any such use of TI products which TI has not designated as military-grade is solely at the Buyer's risk, and that they are solely responsible for compliance with all legal and regulatory requirements in connection with such use.

TI products are neither designed nor intended for use in automotive applications or environments unless the specific TI products are designated by TI as compliant with ISO/TS 16949 requirements. Buyers acknowledge and agree that, if they use any non-designated products in automotive applications, TI will not be responsible for any failure to meet such requirements.

Following are URLs where you can obtain information on other Texas Instruments products and application solutions:

Products

Audio	www.ti.com/audio
Amplifiers	amplifier.ti.com
Data Converters	dataconverter.ti.com
DLP® Products	www.dlp.com
DSP	dsp.ti.com
Clocks and Timers	www.ti.com/clocks
Interface	interface.ti.com
Logic	logic.ti.com
Power Mgmt	power.ti.com
Microcontrollers	microcontroller.ti.com
RFID	www.ti-rfid.com
OMAP Mobile Processors	www.ti.com/omap
Wireless Connectivity	www.ti.com/wirelessconnectivity

Applications

Automotive and Transportation	www.ti.com/automotive
Communications and Telecom	www.ti.com/communications
Computers and Peripherals	www.ti.com/computers
Consumer Electronics	www.ti.com/consumer-apps
Energy and Lighting	www.ti.com/energy
Industrial	www.ti.com/industrial
Medical	www.ti.com/medical
Security	www.ti.com/security
Space, Avionics and Defense	www.ti.com/space-avionics-defense
Video and Imaging	www.ti.com/video

TI E2E Community Home Page

e2e.ti.com

Mailing Address: Texas Instruments, Post Office Box 655303, Dallas, Texas 75265
Copyright © 2012, Texas Instruments Incorporated