

AN–1367 LM5115 HV DC Evaluation Board

1 Introduction

The LM5115 HV DC evaluation board provides a synchronous buck dc-dc converter using the LM5115 secondary side post regulator control IC.

The evaluation board specifications are:

- DC Input voltage range: 7V to 70V
- Regulated Output voltage: 5V
- Output current range: 0 to 6A
- Measured efficiency: 94% at 1.5A, $V_{IN} = 24V$
- Load regulation: 0.1% (1A-6A)
- Switching Frequency: 215kHz, typical
- Onset of current limiting: $\approx 8A$
- Board Size: 3.0 x 1.7 x 0.43in

The printed circuit board (PCB) consists of 4 layers of 2 oz copper on FR4 material, with a thickness of 0.050 in. It is designed for continuous operation at rated load with a minimum airflow of 200 LFPM.

2 Theory of Operation

The LM5115 is a secondary side post regulator (SSPR) controller that can be configured as a high voltage DC buck controller. In the buck application, the power input of the LM5115 is a dc voltage instead of a pulsed signal from the transformer secondary winding of an isolated converter (SSPR configuration). The free running oscillator within the LM5115 sets the clock frequency for the high and low side drivers of external synchronous buck power MOSFETs. The LM5115 controls the buck power stage with leading edge pulse width modulation (PWM) to hold off the high side driver until the necessary volt*seconds is established for regulation. A resistor from the VCC bias voltage to the SYNC pin sets the current that charges a RAMP pin capacitor for voltage mode PWM control. The internal oscillator terminates the buck switch pulse and discharges the RAMP capacitor before initiating another cycle. Adaptive deadtime control delays the top and bottom drivers to avoid shoot through currents. See typical and adaptive delay waveforms in [Figure 10](#) and [Figure 11](#).

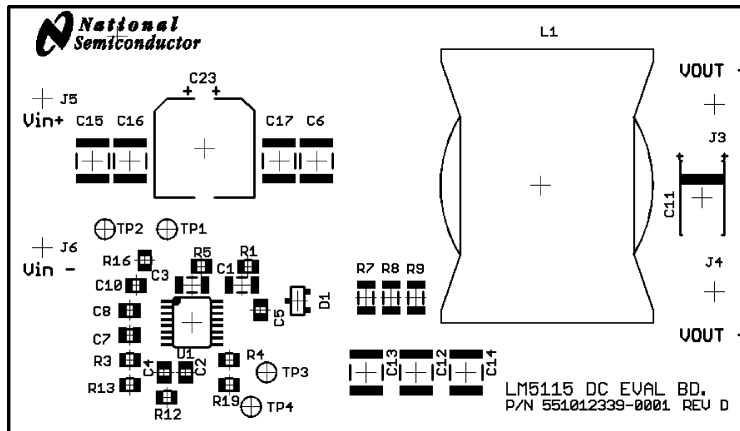

TOP SILKSCREEN (.PLC) LAYER AS VIEWED FROM TOP

Figure 1. DC Evaluation Board Top Side

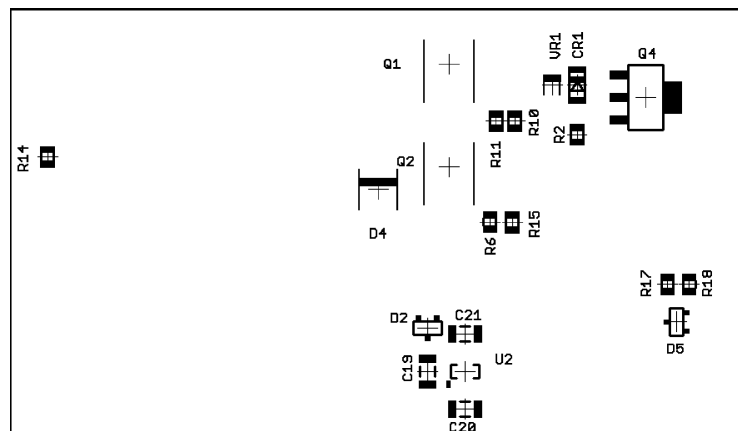

Figure 2. Evaluation Board Bottom Side

3 Board Layout and Probing

Figure 1 and Figure 2 shows the board layout, main components, and critical probe points for testing the LM5115 DC mode evaluation board. The following notes should be considered prior to applying power to the board:

- Main input power (7V to 70V) is applied to points J5 and J6, connected to VIN and GND, respectively.
- The main current carrying components (L1, Q1, and Q2) will be hot to the touch at maximum load current. USE CAUTION. When operating at load currents in excess of 3A the use of a fan to provide forced air flow **IS NECESSARY**.
- The diameter and length of the wire used to connect the load is important. To ensure that there is not a significant voltage drop in the wires, a minimum of 14 gauge wire is recommended.

4 Board Connections/Start-Up

The input connections are made to terminals J5 (+) and J6 (-). The input source must be capable of supplying the load dependent input current shown in Figure 3. The load is connected to terminals J3 (+) and J4 (-). Before start-up, a voltmeter should be connected to the input terminals and to the output terminals. The input current should be monitored with an ammeter or a current probe. Soft-start provided by the LM5115 will insure that the output rises with a smooth turn on without overshoot (Figure 8). The LM5115 evaluation board operates in the continuous conduction mode even with a light or no load.

5 Performance LM5115 DC - DC Regulator

Performance of the LM5115 evaluation board can be seen in the following figures:

- Power Conversion Efficiency ([Figure 4](#))
- Load Regulation ([Figure 5](#))
- Step Load Response ([Figure 6](#))
- Ripple Voltage ([Figure 7](#))
- Gate Delays ([Figure 7](#) and [Figure 8](#))
- Startup and Shutdown Response ([Figure 8](#) and [Figure 9](#))
- Operational Waveforms ([Figure 10](#) to [Figure 13](#))
- Output Short Circuit Response ([Figure 14](#))

6 V_{BIAS}

V_{BIAS} is initially powered up by the input supply through a 6.2V clamp and an NPN. Once VOUT is regulating the voltage doubler will supply a doubled output voltage (10V) to Vbias.

7 V_{CC}

The LM5115 produces a LDO 7V regulated output (V_{CC}) that can supply up to 40mA of DC current. In the DC evaluation board, the V_{CC} supplies the control current that sets the frequency of the oscillator. The V_{CC} regulator also supplies power for the high current gate drive for the low side MOSFET and the bootstrap capacitor of the high side MOSFET driver.

8 Current Limit Operation

Inductor current is sensed through the parallel resistances of R7, R8, and R9. The resistor values are designed for a current limit of $\approx 8A$. Current limiting occurs when the sense resistor voltage exceeds 45mV threshold causing the current sense amplifier to pull down the CO and COMP pins. Pulling CO and COMP low reduces the width of pulses to the high side driver, limiting the output current of the converter. After reaching the current limit, the voltage feedback causes the COMP pin to rise and turn on the high side driver until the inductor current again reaches the $\approx 8A$ current limit threshold. ([Figure 14](#)).

9 Foldback Current Limit

Current limit foldback can be implemented with the following components: R17, R18, D5, and R16 (see [Figure 16](#)). At nominal output voltage ($V_{OUT} > 3V$) D5 is reversed biased and the current limit threshold is still $\approx 45mV$. At lower output voltage the resistor divider network along with the forward biased diode (D5) will increase the voltage across R16. In order to reach the 45mV current limit threshold, the voltage across the sense resistor (R7-R9) is reduced due to the increase in voltage across R16. Thus, the current limit is reduced providing current limit foldback. The resistor divider sets the voltage when current limit foldback kicks in and R16 sets the amount of current limit foldback.

10 Internal Oscillator

The frequency of the dc-dc converter system is set by the VCC voltage, the SYNC pin resistor (R4), and the RAMP pin capacitor (C4) according to [Equation 1](#):

$$F_{CLK} = \frac{1}{\frac{(C4 \times 2.25V)}{(VCC/R4 \times 3)} + 300 \text{ ns}} \approx 215 \text{ kHz} \quad (1)$$

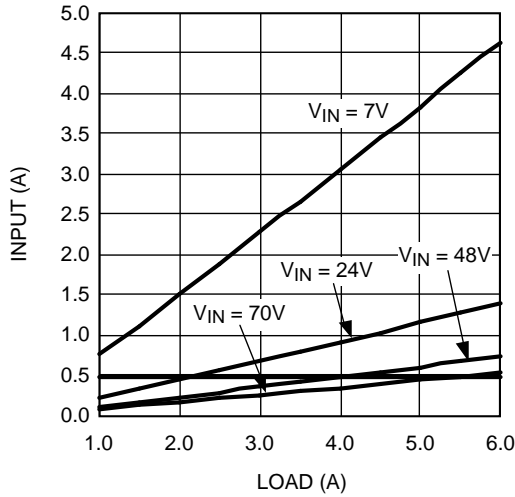

Figure 3. Input Current vs Load Current

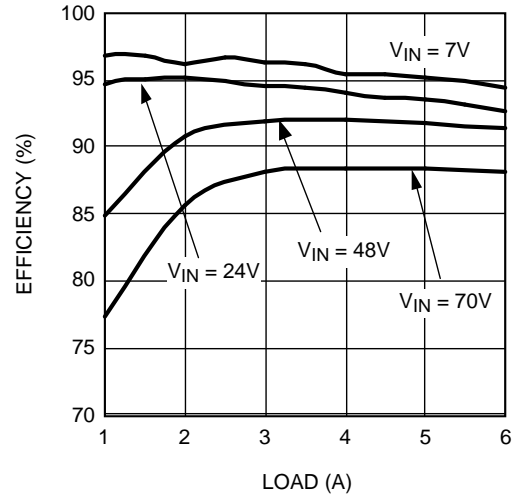

Figure 4. System Efficiency vs. Load Current and V_{IN}

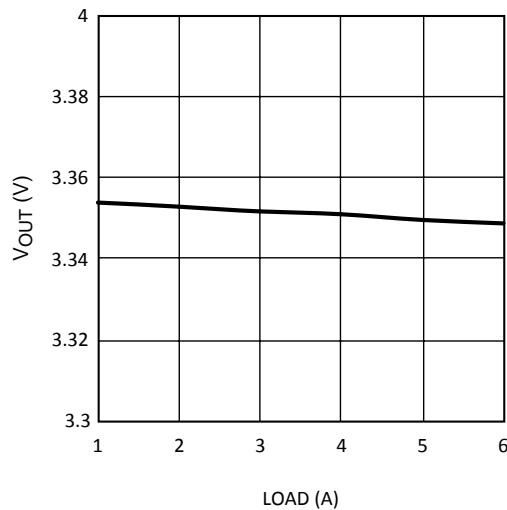
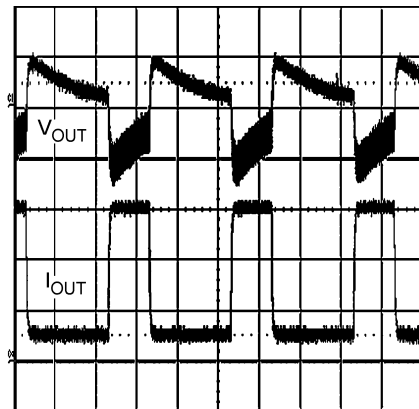
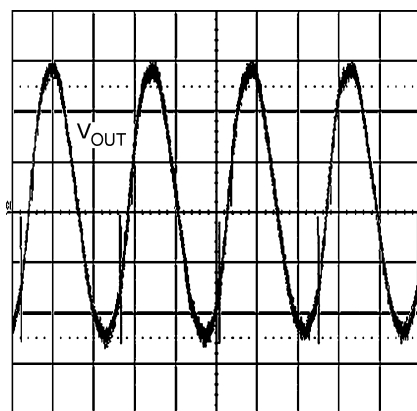

Figure 5. Output Voltage vs. Load Current



Conditions: $V_{IN} = 24V$ CH1= 5V output, 200mV/div (AC mode) CH4 = Output current load (1A to 5A), 2A/div Horizontal Resolution = 1ms/div

Figure 6. Step Load Response



Conditions: $V_{IN} = 24V$, 6A load CH1= 5V output, 20mV/div (AC mode) Horizontal Resolution = 2μs/div

Figure 7. Ripple Voltage

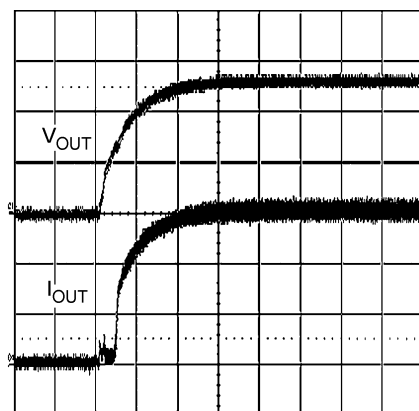

Conditions: $V_{IN}=24V$; Load=6.0A CH1 = 5V Output, 2V/div CH4 = Output Current load, 2A/div Horizontal Resolution = 10ms/div

Figure 8. Startup Response

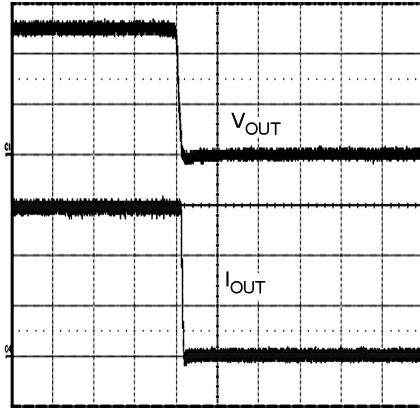

Conditions: VIN=24V; Load=6.0A CH1 = 5V Output, 2V/div
CH4 = Output Current load, 2A/div Horizontal Resolution = 10ms/div

Figure 9. Shutdown Response

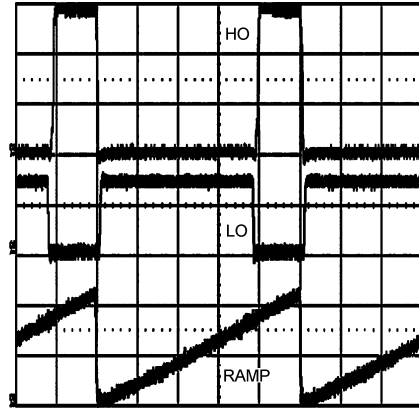

Conditions: VIN = 24V, 1A CH1= High Side Gate Driver (HO), 10V/div CH2= Low Side Gate Driver (LO), 5V/div
CH3= RAMP, 1V/div Horizontal Resolution = 1µs/div

Figure 10. Typical Waveforms

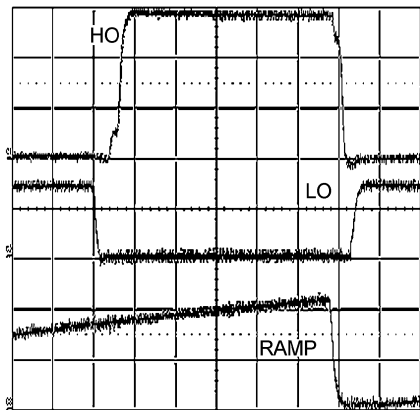

Conditions: VIN = 24V, 1A CH1= High Side Gate Driver (HO), 10V/div CH2= Low Side Gate Driver (LO), 5V/div
CH3= RAMP, 1V/div Horizontal Resolution = 200ns/div

Figure 11. Adaptive Delays

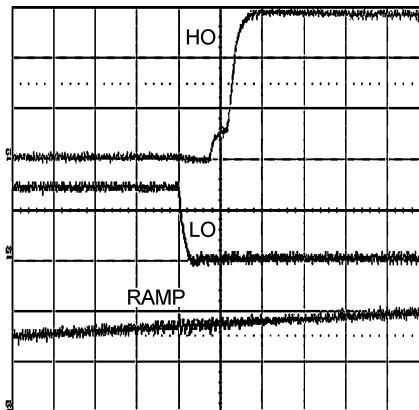

Conditions: VIN = 24V, 1A CH1= High Side Gate Driver (HO), 10V/div CH2= Low Side Gate Driver (LO), 5V/div
CH3= RAMP, 1V/div Horizontal Resolution = 100ns/div

Figure 12. Gate Turn-on Delay

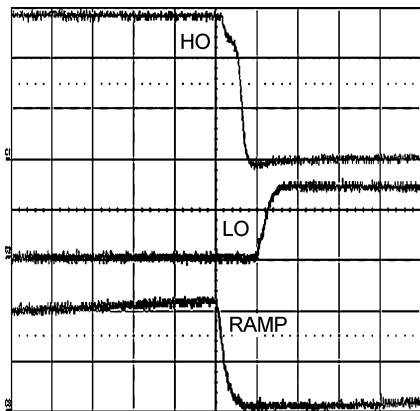

Conditions: VIN = 24V, 1A CH1= High Side Gate Driver (HO), 10V/div CH2= Low Side Gate Driver (LO), 5V/div
CH3= RAMP, 1V/div Horizontal Resolution = 100ns/div

Figure 13. Gate Turn-off Delay

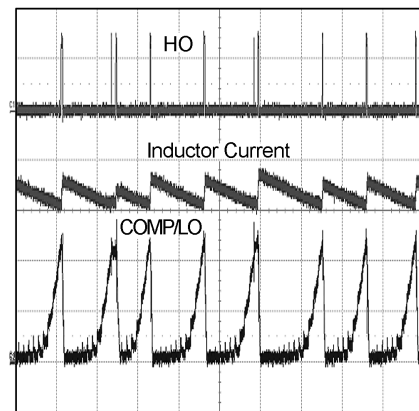

Conditions: VIN = 24V, Short Circuit Load CH1= High Side Gate Driver (HO), (20V/div) CH2= COMP/CO, (1V/div) CH4=
Inductor current (2A/div) Horizontal Resolution = 50µs/div

Figure 14. Output Short Circuit Response

11 Application Circuit Schematic

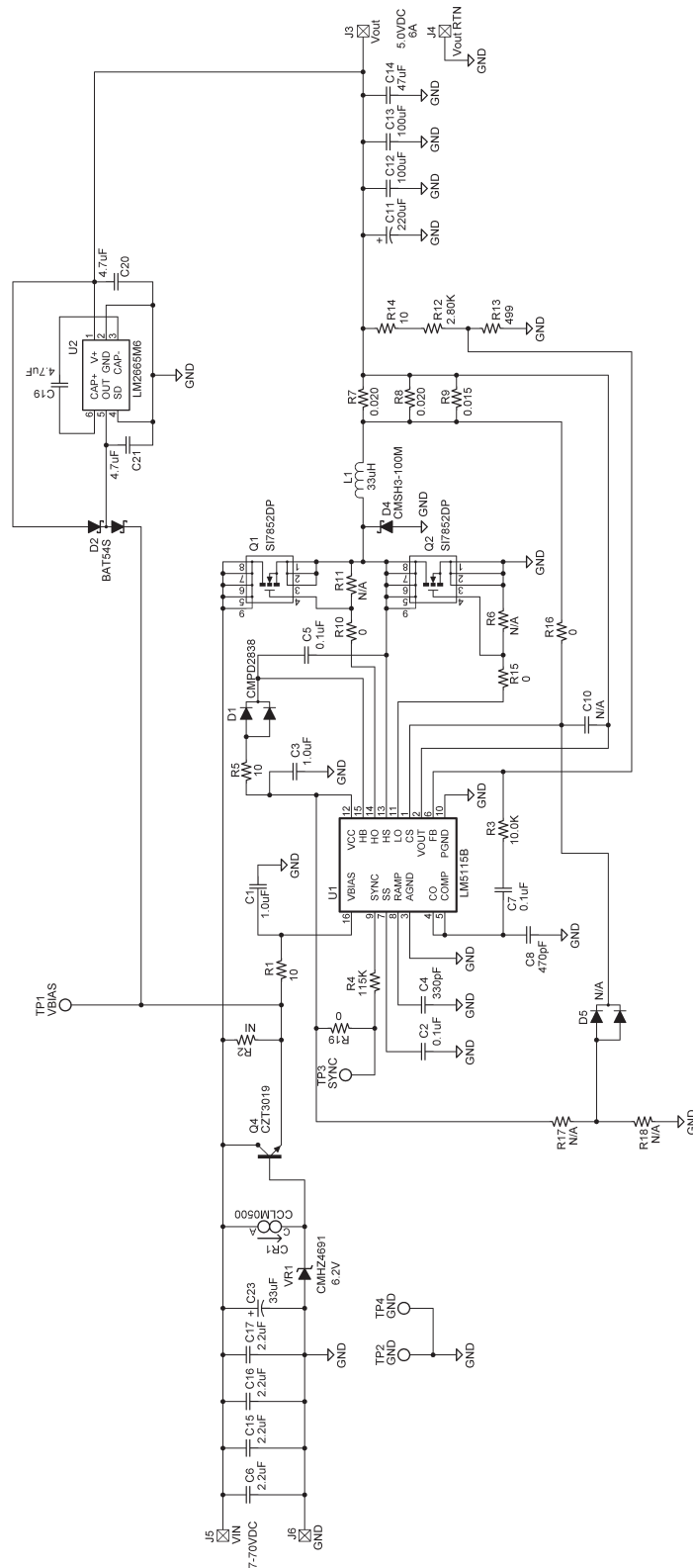

Figure 15. LM5115 HV DC Evaluation Board

12 Bill of Materials (BOM)
Table 1. Bill of Materials

Item		Part Number	Description	Value
C	1	C3216X7R1C105K	CAPACITOR, CER, TDK	1.0 μ F, 16V
C	2	C2012X7R1H104K	CAPACITOR, CER, TDK	0.1 μ F, 50V
C	3	C3216X7R1C105K	CAPACITOR, CER, TDK	1.0 μ F, 16V
C	4	C2012C0G1H331K	CAPACITOR, CER, TDK	330 pF, 50V
C	5	C2012X7R1H104K	CAPACITOR, CER, TDK	0.1 μ F, 50V
C	6	C4532X7R2A225M	CAPACITOR, CER, TDK	2.2 μ F, 100V
C	7	C2012X7R1H104K	CAPACITOR, CER, TDK	0.1 μ F, 50V
C	8	C2012C0G1H471K	CAPACITOR, CER, TDK	470 pF, 50V
C	10			Not Used
C	11	EEFUE0J221R	CAPACITOR, SP, PANASONIC	220 μ F, 6.3V
C	12	C4532X7R0J107M	CAPACITOR, CER, TDK	100 μ F, 6.3V
C	13	C4532X7R0J107M	CAPACITOR, CER, TDK	100 μ F, 6.3V
C	14	C4532X7R0J476M	CAPACITOR, CER, TDK	47 μ F, 6.3V
C	15	C4532X7R2A225M	CAPACITOR, CER, TDK	2.2 μ F, 100V
C	16	C4532X7R2A225M	CAPACITOR, CER, TDK	2.2 μ F, 100V
C	17	C4532X7R2A225M	CAPACITOR, CER, TDK	2.2 μ F, 100V
C	19	C3216X7R1C475M	CAPACITOR, CER, TDK	4.7 μ F, 16V
C	20	C3216X7R1C475M	CAPACITOR, CER, TDK	4.7 μ F, 16V
C	21	C3216X7R1C475M	CAPACITOR, CER, TDK	4.7 μ F, 16V
C	23	EEVFK2A330P	CAPACITOR, CER,	33 μ F, 100V
CR	1	CCLM0500	CURRENT REGULATOR, CENTRAL, SEMI	0.5mA, 100V
D	1	CMPD2838E-NSA	DIODE, SIGNAL, CENTRAL, SEMI	200mA, 120V
D	2	BAT54S	DIODE SHOTTKY, CENTRAL, SEMI	200mA, 30V
D	4	CMSH3-100M	DIODE SHOTTKY, CENTRAL, SEMI	3A, 100v
D	5			Not Used
J	3	2515-1-01-01-00-00-07-0	SOLDER TERMINAL SLOTTED, MILL-MAX	VOUT
J	4	2515-1-01-01-00-00-07-0	SOLDER TERMINAL SLOTTED, MILL-MAX	VOUT RTN
J	5	3104-2-00-01-00-00-08-0	TERMINAL, SOLDER, .040" MILL-MAX	VIN
J	6	3104-2-00-01-00-00-08-0	TERMINAL, SOLDER, .040" MILL-MAX	GND
TP	1	5002	TERMINAL, SMALL TEST POINT, KEYSTONE	VBIAS
TP	2	5002	TERMINAL, SMALL TEST POINT, KEYSTONE	GND
TP	3	5002	TERMINAL, SMALL TEST POINT, KEYSTONE	SYNC
TP	4	5002	TERMINAL, SMALL TEST POINT, KEYSTONE	GND
R	1	CRCW080510R0J	RESISTOR, VISHAY	10
R	2			Not Used
R	3	CRCW08051002F	RESISTOR, VISHAY	10.0k Ω
R	4	CRCW08051153F	RESISTOR, VISHAY	115k Ω
R	5	CRCW080510R0J	RESISTOR, VISHAY	10 Ω
R	6			Not Used
R	7	CRCW1206R02F	RESISTOR, VISHAY ,	0.02 Ω
R	8	CRCW1206R02F	RESISTOR, VISHAY ,	0.02 Ω
R	9	CRCW1206R015F	RESISTOR, VISHAY ,	0.015 Ω
R	10	CRCW08050000Z	RESISTOR, VISHAY	0 Ω
R	11			Not Used
R	12	CRCW08052801F	RESISTOR, VISHAY	2.80k Ω

Table 1. Bill of Materials (continued)

Item		Part Number	Description	Value
R	13	CRCW08054990F	RESISTOR, VISHAY	499Ω
R	14	CRCW080510R0J	RESISTOR, VISHAY	10Ω
R	15	CRCW08050000Z	RESISTOR, VISHAY	0Ω
R	16	CRCW08050000Z	RESISTOR, VISHAY	0Ω
R	17			Not Used
R	18			Not Used
R	19	CRCW08050000Z	RESISTOR, VISHAY	0Ω
Q	1	SI7852DP	MOSFET, N-CH, POWER S0-8 PKG, VISHAY	80V, 11A
Q	2	SI7852DP	MOSFET, N-CH, POWER S0-8 PKG, VISHAY	80V, 11A
Q	4	CZT3019	NPN, CENTRAL SEMI	120V, 2W
L	1	D1787-AL	CUSTOM INDUCTOR, COILCRAFT	33 μH - 6A
U	1	LM5115	IC, SECONDARY SIDE CONTROLLER	LM5115
U	2	LM2665M6	IC, CHARGE PUMP CONVERTER	LM2665
VR	1	CMHZ4691	DIODE, ZENER,	6.2V

13 PCB Layout(s)

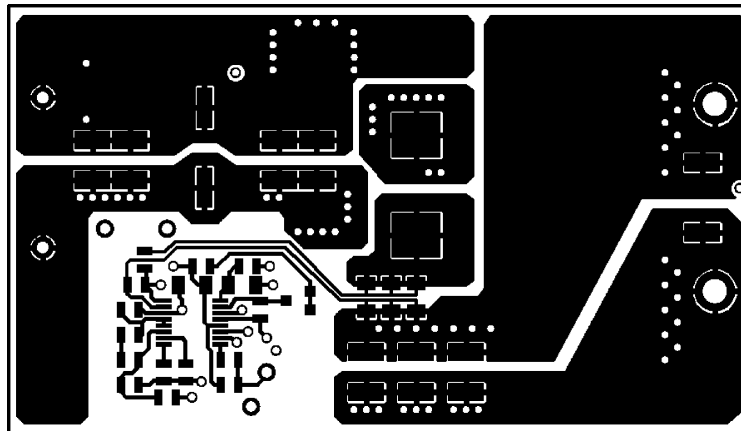

TOP (.CMP) LAYER AS VIEWED FROM TOP

Figure 17. Top Layer

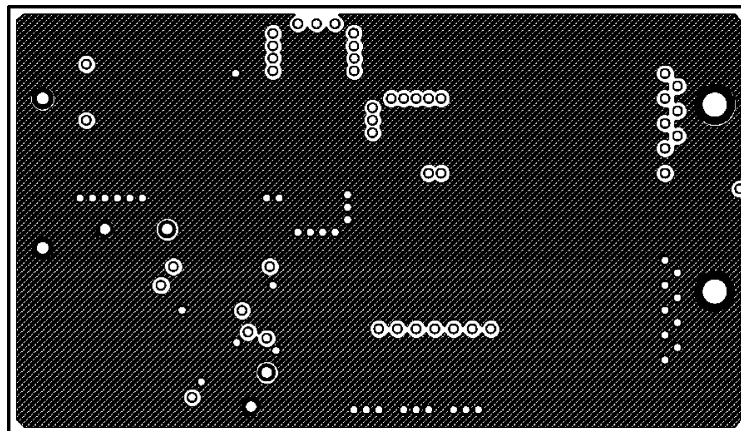

LAYER 2 (.LY2) AS VIEWED FROM TOP

Figure 18. Layer 2

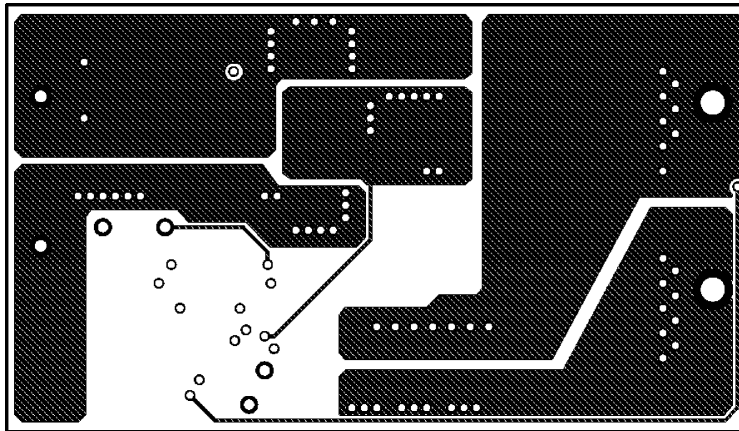

LAYER 3 (LY3) AS VIEWED FROM TOP

Figure 19. Layer 3

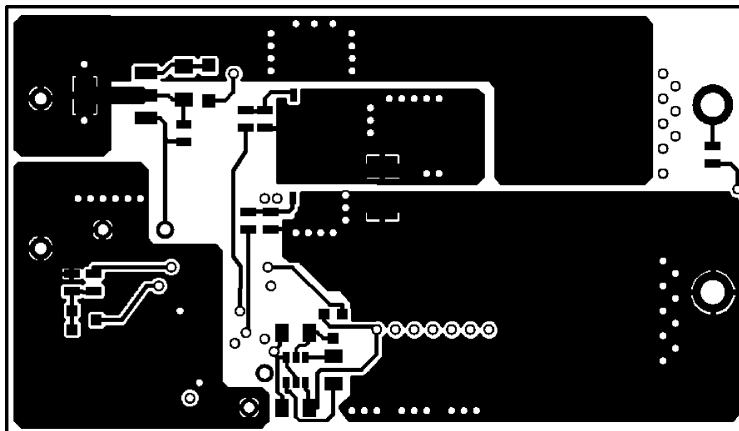

BOTTOM (SOL) LAYER AS VIEWED FROM TOP

Figure 20. Bottom Layer LM5115, as Viewed from Top

IMPORTANT NOTICE

Texas Instruments Incorporated and its subsidiaries (TI) reserve the right to make corrections, enhancements, improvements and other changes to its semiconductor products and services per JESD46, latest issue, and to discontinue any product or service per JESD48, latest issue. Buyers should obtain the latest relevant information before placing orders and should verify that such information is current and complete. All semiconductor products (also referred to herein as "components") are sold subject to TI's terms and conditions of sale supplied at the time of order acknowledgment.

TI warrants performance of its components to the specifications applicable at the time of sale, in accordance with the warranty in TI's terms and conditions of sale of semiconductor products. Testing and other quality control techniques are used to the extent TI deems necessary to support this warranty. Except where mandated by applicable law, testing of all parameters of each component is not necessarily performed.

TI assumes no liability for applications assistance or the design of Buyers' products. Buyers are responsible for their products and applications using TI components. To minimize the risks associated with Buyers' products and applications, Buyers should provide adequate design and operating safeguards.

TI does not warrant or represent that any license, either express or implied, is granted under any patent right, copyright, mask work right, or other intellectual property right relating to any combination, machine, or process in which TI components or services are used. Information published by TI regarding third-party products or services does not constitute a license to use such products or services or a warranty or endorsement thereof. Use of such information may require a license from a third party under the patents or other intellectual property of the third party, or a license from TI under the patents or other intellectual property of TI.

Reproduction of significant portions of TI information in TI data books or data sheets is permissible only if reproduction is without alteration and is accompanied by all associated warranties, conditions, limitations, and notices. TI is not responsible or liable for such altered documentation. Information of third parties may be subject to additional restrictions.

Resale of TI components or services with statements different from or beyond the parameters stated by TI for that component or service voids all express and any implied warranties for the associated TI component or service and is an unfair and deceptive business practice. TI is not responsible or liable for any such statements.

Buyer acknowledges and agrees that it is solely responsible for compliance with all legal, regulatory and safety-related requirements concerning its products, and any use of TI components in its applications, notwithstanding any applications-related information or support that may be provided by TI. Buyer represents and agrees that it has all the necessary expertise to create and implement safeguards which anticipate dangerous consequences of failures, monitor failures and their consequences, lessen the likelihood of failures that might cause harm and take appropriate remedial actions. Buyer will fully indemnify TI and its representatives against any damages arising out of the use of any TI components in safety-critical applications.

In some cases, TI components may be promoted specifically to facilitate safety-related applications. With such components, TI's goal is to help enable customers to design and create their own end-product solutions that meet applicable functional safety standards and requirements. Nonetheless, such components are subject to these terms.

No TI components are authorized for use in FDA Class III (or similar life-critical medical equipment) unless authorized officers of the parties have executed a special agreement specifically governing such use.

Only those TI components which TI has specifically designated as military grade or "enhanced plastic" are designed and intended for use in military/aerospace applications or environments. Buyer acknowledges and agrees that any military or aerospace use of TI components which have **not** been so designated is solely at the Buyer's risk, and that Buyer is solely responsible for compliance with all legal and regulatory requirements in connection with such use.

TI has specifically designated certain components as meeting ISO/TS16949 requirements, mainly for automotive use. In any case of use of non-designated products, TI will not be responsible for any failure to meet ISO/TS16949.

Products

Audio	www.ti.com/audio
Amplifiers	amplifier.ti.com
Data Converters	dataconverter.ti.com
DLP® Products	www.dlp.com
DSP	dsp.ti.com
Clocks and Timers	www.ti.com/clocks
Interface	interface.ti.com
Logic	logic.ti.com
Power Mgmt	power.ti.com
Microcontrollers	microcontroller.ti.com
RFID	www.ti-rfid.com
OMAP Applications Processors	www.ti.com/omap
Wireless Connectivity	www.ti.com/wirelessconnectivity

Applications

Automotive and Transportation	www.ti.com/automotive
Communications and Telecom	www.ti.com/communications
Computers and Peripherals	www.ti.com/computers
Consumer Electronics	www.ti.com/consumer-apps
Energy and Lighting	www.ti.com/energy
Industrial	www.ti.com/industrial
Medical	www.ti.com/medical
Security	www.ti.com/security
Space, Avionics and Defense	www.ti.com/space-avionics-defense
Video and Imaging	www.ti.com/video

TI E2E Community

e2e.ti.com