

## **AN-2176 LM10010 Evaluation Board**

---

---

---

### **1 LM10010 Overview**

The LM10010 is a precision, digitally programmable device used to control the output voltage of a DC/DC converter. The LM10010 outputs a DC current inversely proportional to a 6-bit input word. This current DAC output connects to the feedback pin of a buck converter in order to adjust its output voltage to a desired range and resolution set by the user. As the 6-bit word counts up, the output voltage is adjusted higher based on the setting of the feedback resistors in the buck converter.

### **2 Introduction**

This evaluation module provides a VID interface to test the LM10010 and its control of an LM21215A-1 buck regulator. The LM21215A-1 is capable of driving up to 15A of continuous load current with excellent output voltage accuracy due to its  $\pm 1\%$  internal reference and high gain error amplifier. This device also features a clock synchronization input that allows the switching frequency to be synchronized to an external clock source. In this evaluation board, the LM10010 is used to control and adjust the output voltage through its 4-pin VID interface. The input voltage can be operated from 2.97V to 5.5V. On power-up, the output voltage defaults to 1.0V. The evaluation board allows for control of the LM21215A-1 output voltage from 0.7V to 1.1V in 6.4mV steps. The evaluation board also includes a 10-pin header used for communication with the LM10010. A communications dongle is provided along with software to control the output voltage through a graphical user interface (GUI) and an USB port. This application note describes the various functions of the board, how to test and evaluate it, and how to use the GUI design tool to change the components for a specific application. Please check *LM10010 VID Voltage Programmer for Point of Load Regulator* ([SNVS717](#)) data sheet for the latest software and data sheet information. For more information on the LM21215A-1 and its operation, please consult the *LM21215A-1 15A High Efficiency Synchronous Buck Regulator with Frequency Synchronization* ([SNOSB87](#)) data sheet and the *AN-2131 LM21215A-1 Evaluation Board* ([SNVA477](#)) evaluation board application note.

### **3 PCB Features**

- Input voltage range: 3.0V to 5.5V
- Programmable output voltage: 0.7V to 1.1V
- Over current protection: 17A
- PCB Size: 2.1" x 2.1"
- Solution Size: 1.0" x 1.0"
- USB connection through communications dongle
- Software control with graphical user interface

## 4 Evaluation Board Schematic

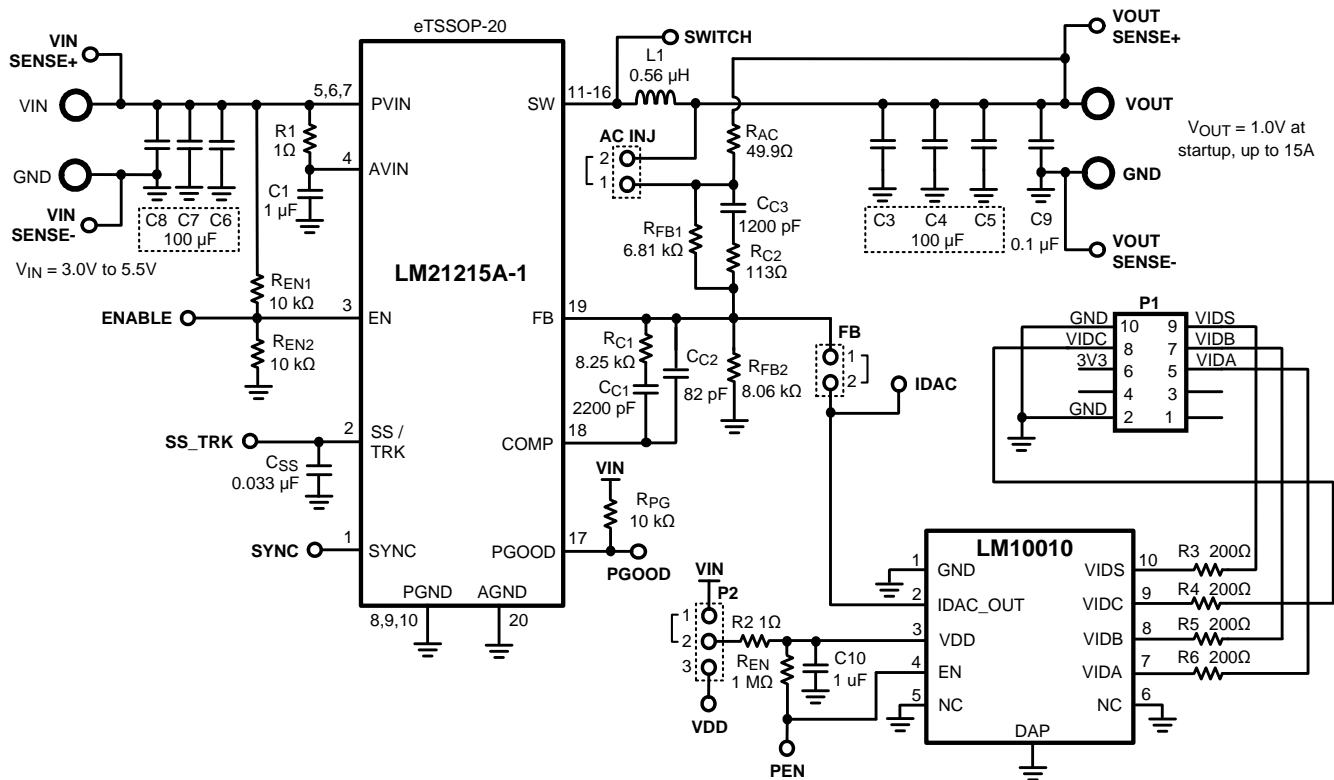

## 5 Powering and Loading Considerations

Read this entire page prior to attempting to power the evaluation board.

### 5.1 Getting Started

The LM10010 evaluation kit hardware is shown in [Figure 1](#), where it shows that the board offers a connection for the system input voltage on the left side and a connection for the load on the bottom. To the right of the LM10010 evaluation module is a communications dongle. It is connected to the board through the 10 pin right angle header and is used to communicate with the LM10010. A USB cable connects the dongle to a USB port on the computer for software control.

To start using the LM10010 evaluation module, the first step is to connect the LM10010 board to its power supply while limiting the supply current to ensure that everything is connected correctly. Separately, the dongle is connected to the computer with the USB cable and the software is installed onto the computer. Once these steps are taken, then the dongle can be connected to the evaluation board to run the complete evaluation module.

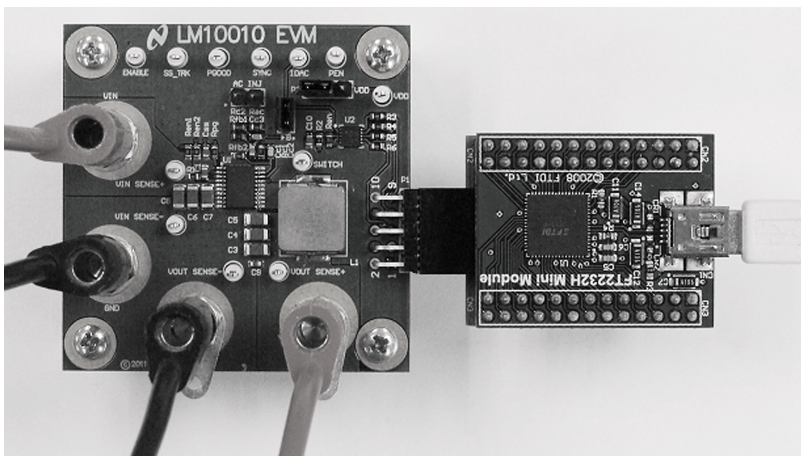

**Figure 1. LM10010 Evaluation Kit Hardware**

## 5.2 Quick Setup Procedure for Board

**Step 1:** Set the input source current limit to 10A. Turn off the input source. Connect the positive output of the input source to  $V_{IN}$  and the negative output to the corresponding GND.

**Step 2:** Connect the load (with 15A capability) to  $V_{OUT}$  for the positive connection and GND for the negative connection.

**Step 3:** The ENABLE pin should be left open for normal operation.

**Step 4:** Set the input source voltage to 5V. The load voltage should be in regulation with a nominal 1.0V output.

**Step 5:** Slowly increase the load while monitoring the load voltage at  $V_{OUT}$ . It should remain in regulation with a nominal 1.0V output as the load is increased up to 15A.

**Step 6:** Slowly sweep the input source voltage from 2.95V to 5.5V. The load voltage should remain in regulation with a nominal 1.0V output. If desired, the output of the device can be disabled by connecting the ENABLE pin to GND.

**Step 7:** The frequency of operation can be varied as desired by connecting a 2.0V square-wave positive signal between SYNC and GND.

## 5.3 Powering Up

It is suggested that the load power be kept low during the first power up. Once the device is powered up, immediately check for 1.0V at the output.

A quick efficiency check is the best way to confirm that everything is operating properly. If something is amiss you can be reasonably sure that it will adversely affect the efficiency. Few parameters can be incorrect in a switching power supply without creating losses and potentially damaging temperature.

Some voltage supplies can exhibit severe voltage overshoot during high current transients. If a supply overshoots above 6.0V, damage to the LM21215A-1 or the LM10010 can occur. For these supplies, a large capacitor across the terminals of the supply (1000 $\mu$ F) can alleviate this problem.

## 5.4 Over Current Protection

The evaluation board is configured with over-current protection. This function is completely contained in the LM21215A-1. The peak current is limited to approximately 17A.

## 5.5 Quick Setup Software Control

Once the LM10010 evaluation board is setup and the LM21215A-1 is determined to be correctly regulating the output voltage, the software can be installed and communication can then be established with the LM10010. In the evaluation board kit, there should be a CD with all the necessary files including a readme file explaining the installation process. First, the drivers for the communications dongle are installed, and then the control software is installed.

These files should be executed on a PC running Windows XP or later to install the software.

## 6 Device Evaluation

Once the software is installed, you can connect the dongle to the evaluation board to complete the communications. After configuring the hardware connections, apply an input voltage of 5V to the device. The current hardware configuration allows the LM10010EVM to work from 3.0V to 5.5V system rails.

Double click on the GUI executable in the installation folder from the previous installation step. The evaluation board should be ready for control and the program front panel should appear. For an explanation of how the program is used, see [Section 10](#).

## 7 Connection Descriptions

Terminal Silkscreen	Description
VIN	This terminal is the input voltage to the device. The evaluation board will operate over the input voltage range of 3.0V to 5.5V.
GND	These terminals are the ground connections to the device. The input power ground should be connected next to the input VIN connection, and the output power ground next to the VOUT connection.
VOUT	This terminal connects to the output voltage of the power supply and should be connected to the load.
ENABLE	This terminal connects to the enable pin of the LM21215A-1. This terminal can be left floating or driven externally. If left floating, a 2 $\mu$ A current source will pull the pin high, thereby enabling the device. If driven externally, a voltage typically less than 1.2V will disable the device.
SS/TRK	This terminal provides access to the SS/TRK pin of the LM21215A-1. Connections to this terminal are not needed for most applications. The feedback pin of the device will track the voltage on the SS/TRK pin if it is driven with an external voltage source that is below the 0.6V reference.
PGOOD	This terminal connects to the power good output of the LM21215A-1. This pin is pulled up through a 10 k $\Omega$ pull-up resistor to VIN.
AC INJ	This terminal block allows the user to insert an AC injection signal across a 49.9 $\Omega$ resistor for open loop gain bode measurements. A jumper shorts out this resistor when it is not needed.
SWITCH	This terminal allows easy probing of the switch node. Do not apply any external voltage source to this pin.
SYNC	This terminal connects to the SYNC pin of the LM21215A-1. The regulator can synchronize the SWITCH pin to a SYNC signal with a frequency between 300kHz and 1.5MHz. If this pin is left open, the switching frequency will default to 500kHz.
VIN_SENSE+, VIN_SENSE- VOUT_SENSE+, VOUT_SENSE-	These terminals allow a sense connection on the board for accurate $V_{IN}$ and $V_{OUT}$ measurements, respectively.
IDAC	This terminal connects to the LM10010 IDAC output (IDAC_OUT).
PEN	This terminal connects to the enable pin of the LM10010. This terminal can be left floating or driven externally. If left floating, a 2 $\mu$ A current source will pull the pin high, thereby enabling the device. If driven externally, a voltage typically less than 1.2V will disable the device.
FB	This jumper connects the LM10010 output to the feedback node of the LM21215A-1. If the LM10010 is used to control the output voltage, then this jumper is required. If the LM10010 is to be evaluated alone, then the IDAC_OUT current can be observed at the IDAC connection by removing the jumper.
P1	This terminal block is used to connect the LM10010 evaluation board with the communications dongle.
P2	This terminal block controls the source of power for the LM10010. If a jumper is connected between pins 1 and 2, then the LM10010 supply comes from PVIN. If the jumper is connected from pins 2 and 3, then the LM10010 derives power from an external connection to VDD.
VDD	This terminal can be used as an alternate power source for the LM10010 though terminal block P2.



## 8 Theory of Operation

The LM10010 can be thought of as a D/A converter, converting the VID communication to analog outputs. In this device, the output is a current DAC (IDAC\_OUT), which is connected to the feedback node of a slave regulator. Therefore, all VID data words are decoded into a 6-bit current DAC output. The impedance of the feedback node at DC appears as the top feedback resistor. This is because the control loop of the slave regulator effectively maintains a constant current/voltage across the bottom feedback resistor, and creates low impedance at the  $V_{OUT}$  node. Therefore, as more current is sourced into the feedback node, the more the output voltage is reduced. See Figure 2.

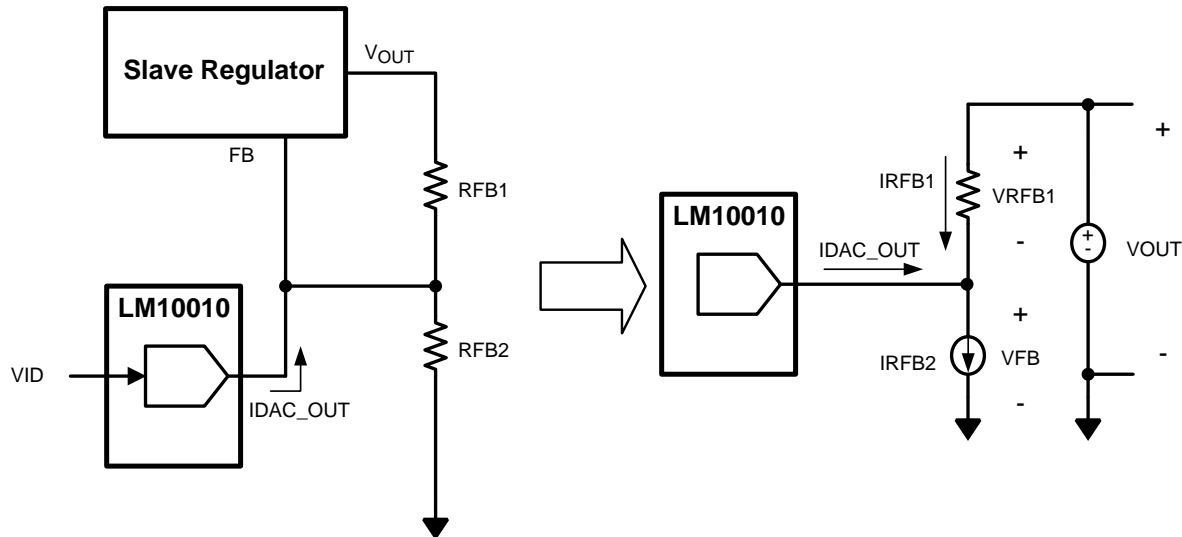

Figure 2. Output voltage is controlled via current injection into the feedback node

Looking at the schematic shown above, the following equation defines  $V_{OUT}$  for a given regulator (valid for  $V_{OUT} > V_{FB}$ ).

$$V_{OUT} = V_{FB} \cdot \left( 1 + \frac{R_{FB1}}{R_{FB2}} \right) - I_{DAC\_OUT} \cdot R_{FB1} \quad (1)$$

For the LM21215A-1,  $V_{FB}$  is 600mV. For the LM10010, the  $I_{DAC\_OUT}$  maximum current is 59.2  $\mu$ A, with 64 settings at a resolution of 940 nA, adjustable with the 6-bit VID word. Note that as the VID codes count up, the output current counts down starting from the highest current. This allows for the  $V_{OUT}$  voltage to increment up with the VID code. For a more in-depth analysis of the circuit, see the LM10010 data sheet.

Table 1 shows the codes and some of the resultant values of IDAC current and corresponding regulator output voltage for the default resistor values on the evaluation board.

Table 1. VID Codes with IDAC Current and Regulator Voltage for the Evaluation Board.

VID Code	IDAC Current ( $\mu$ A)	Regulator Voltage (V)
000000b	59.20	0.7038
000001b	58.26	0.7102
000010b	57.32	0.7166
000011b	56.38	0.7230
...		
111100b	2.82	1.0878
111101b	1.88	1.0941
111110b	0.94	1.1005
111111b	0.00	1.1069

## 9 Evaluation Board

The evaluation board shows how the LM10010 is used to control the LM21215A-1. However, the LM10010 can be run independently without the LM21215A-1 by applying the supply voltage through P2 and jumpering pins 2 and 3. The IDAC output current can be observed at the IDAC pin with the jumper removed from FB.

Additionally, the output voltage and range of the module can be adjusted by replacing components on the board. However, this is not as simple as replacing the feedback resistors  $R_{FB1}$  and  $R_{FB2}$ . A change in the feedback resistors may change the compensation network for the LM21215A-1 and this may require adjustments in values for  $C_{C1}$ ,  $C_{C2}$ ,  $C_{C3}$ ,  $R_{C1}$ , and  $R_{C2}$ . For further guidance with component selection, see the LM21215A-1 data sheet and evaluation board application reports

## 10 Control Software

The LM10010 evaluation board comes with a communications dongle and software to control the output voltage. This section describes software features and modes of operation. The software has a built-in calculator to determine the feedback resistor values for a given range and resolution of operation. This is only used when the user decides to remove the existing default resistor feedback values and determines the LM21215A-1's compensation is correct for the new feedback resistors. The default or updated values are used to calculate expected output voltages of the point of load regulator. Buttons are used to select one of two modes of operation. First, the user can set a constant output voltage for the point of load with either a voltage or a code. Second, the output can be changed dynamically, ramping through different voltages as the LM10010 counts through a preset sequence. The LM10010 software panel is shown in Figure 3 below.

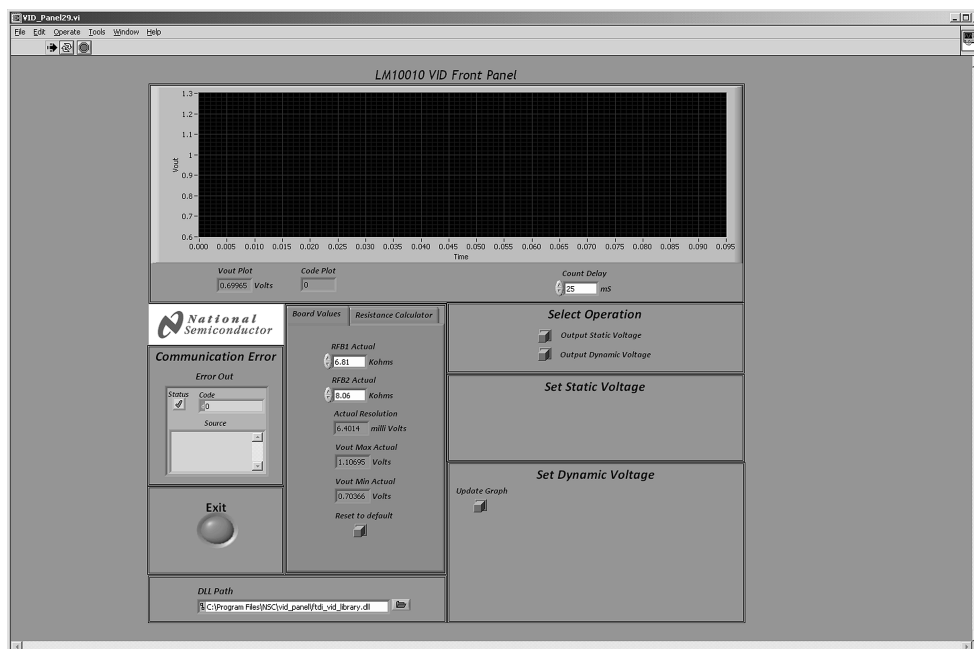

Figure 3. LM10010 Evaluation Software Panel

### 10.1 Resistance Calculator

As mentioned before, this is an optional section that can be used to calculate new resistance values for  $R_{FB1}$  and  $R_{FB2}$ . If the user decides to change the range of the output voltage (from 0.7V to 1.1V) to a different range, then  $R_{FB1}$  and  $R_{FB2}$  should be replaced with new values. If new values are selected, the compensation for the LM21215A-1 may need to be adjusted as well. As shown in Figure 4, the user can set the minimum voltage and the maximum voltage in the desired range. The calculator then determines the proper values for the feedback resistors. The button at the bottom can convert the calculated resistor values to the nearest 1% resistor values available. Another button in the panel can transfer these values to the Board Values panel to calculate the expected output voltage when in operation.

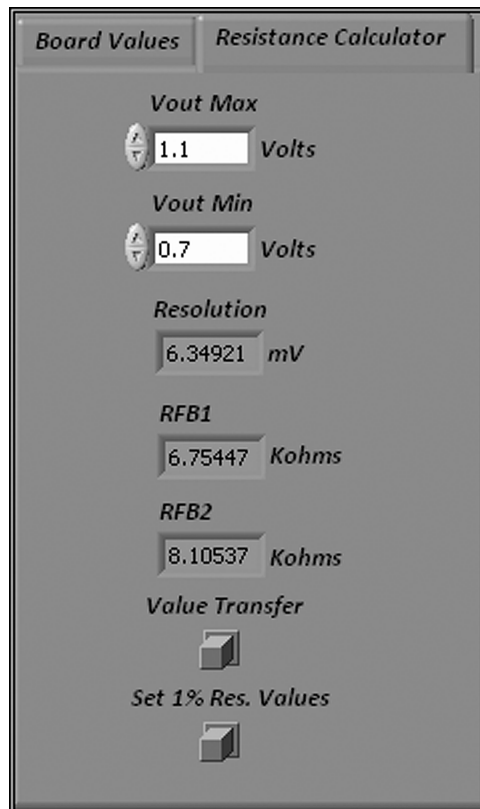

Figure 4. LM10010 Resistance Calculator Tab

## 10.2 Board Values

This section is used to enter resistor feedback values from the board being used. If feedback resistors are changed, the values can be updated here.  $R_{FB1}$  and  $R_{FB2}$  are entered in the top two boxes. This calculates the theoretical maximum output voltage, minimum output voltage and the resolution of the LM10010 steps. If the values are changed to test the program but not changed on the board, a button is provided to re-enter the default values provided for the original board.

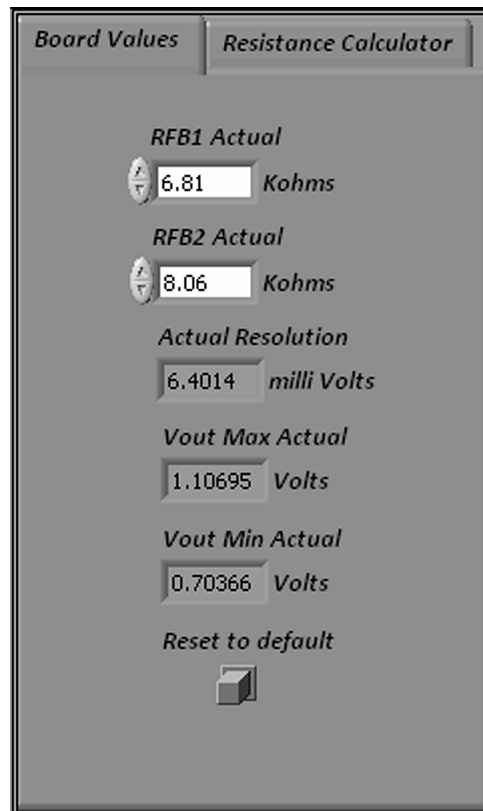

Figure 5. LM10010 Board Values Tab

### 10.3 Select Operation

Once the board values are set (or the defaults are chosen), the user can choose the mode of operation of the evaluation module. In the Select Operation Panel, shown in [Figure 6](#), Set Static Voltage or Set Dynamic Voltage can be chosen by clicking on either button. By making a selection, this will reveal the appropriate control panel for the mode of operation.

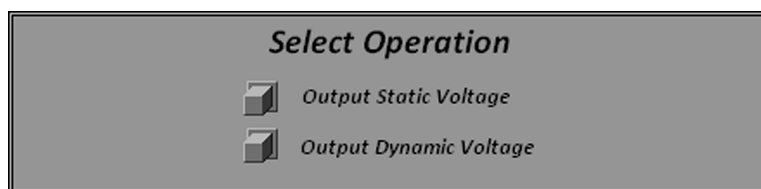

Figure 6. LM10010 Select Operation Panel

### 10.4 Set Static Voltage

The first mode of operation is used to set a static voltage from the point of load. Based on the resistors from the Board Values section, the user can input a voltage and set the output voltage to a desired level. Also, a percentage of margin can be entered and the code can be incremented by the margin percentage up or down dependent on the nearest code value available. The Set Static Voltage panel, with controls entering in the voltage, margin percentage, and buttons to margin up or down the output can be seen in [Figure 7](#).

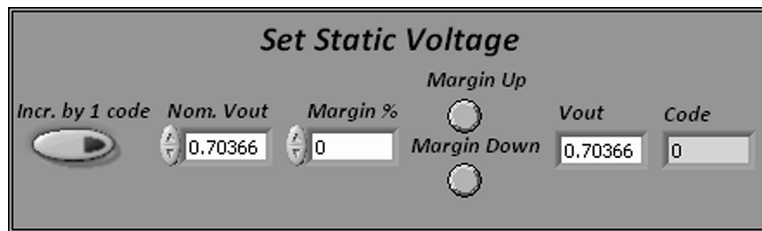

Figure 7. LM10010 Set Static Voltage Panel

The voltage can also be adjusted by incrementing the code with a single button. If the button on the left is selected in the Set Static Voltage Panel, the voltage setting and margining buttons disappear and the voltage can be incremented by single codes up or down as shown below in Figure 8. Buttons to increment the code are to the left of the VOUT box.

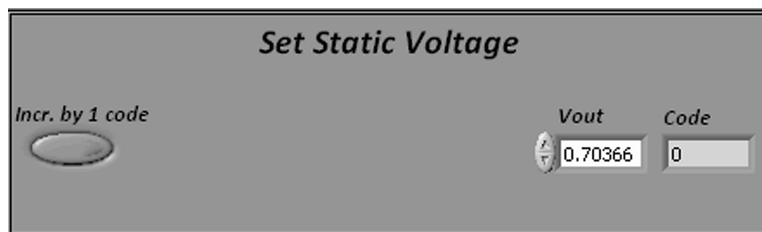

Figure 8. LM10010 Increment Single Code

## 10.5 Set Dynamic Voltage

The second mode of operation can be used to set the voltage by counting through the codes of the LM10010. The Set Dynamic Voltage panel is shown below in Figure 9. In this mode, the user selects to manipulate the output range by either selecting the output voltage or the LM10010 code. The user then sets the starting point, the stopping point, and the increment for each step. The Count Delay box within the Plotter panel in Figure 10 is used to set the time between each increment. The program will then run through the count from the start to the stop in the proper increments in time intervals set by the count delay. It will also repeat this count until the user decides to terminate the program or selects to set the static voltage.

The Update Graph button is used to show a sample of the expected the output waveform in the Plotter panel of the software. Please note that the LM10010 can be run faster than with the 25 ms minimum delay time set in the software. This limitation is set by the timing of the USB communications of the dongle. Another note about changes in the output voltage going negative also concerns the delay time. If there is a light load or no load on the LM21215A-1, the change in the output may be slower because the device enters diode emulation mode.

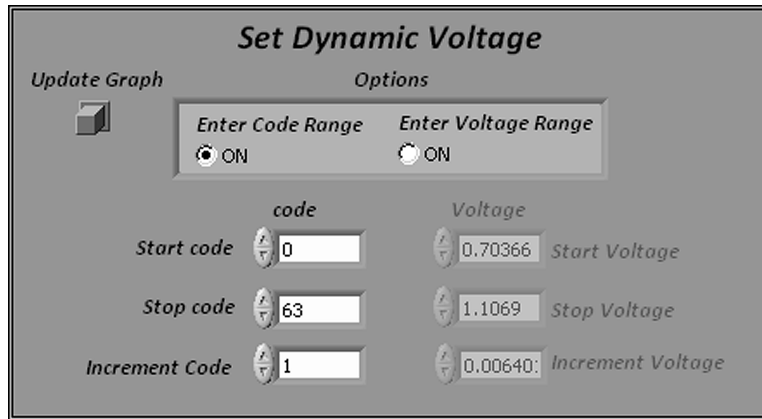

Figure 9. LM10010 Set Dynamic Voltage Panel

### 10.6 Plotter

A plotter is provided to show the output voltage of the board. This is a simple diagnostic tool and only shows the expected output voltage since there are no measurement tools or communications from the board to the computer. In the set constant voltage mode, the plotter is automatically updated. In the set dynamic voltage mode, the plotter is updated by the update plot button. Figure 10 shows the Plotter Panel of the LM10010 software. Vout Plot box shows the expected output voltage, the Code Plot box shows the current code, and the Count Delay box shows the delay between updates in the count used in the Set Dynamic Voltage panel. In this example, the count starts at code 0, and ends at code 63, with an increment code of 4.

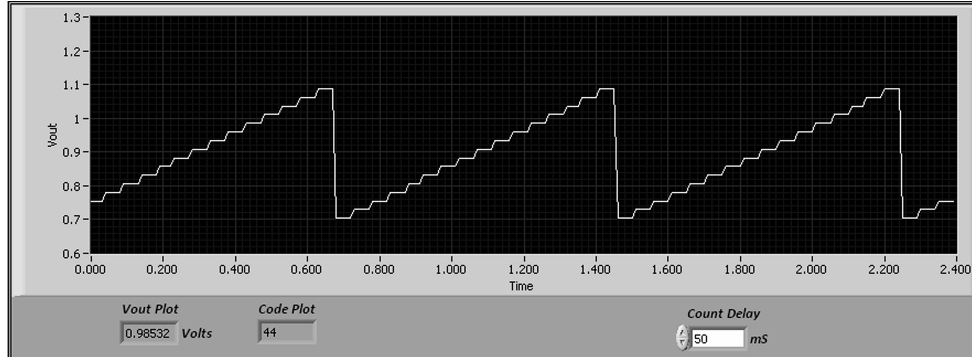

Figure 10. LM10010 Plotter Panel



## 11 Bill of Materials

The Bill of Materials is shown below, including the manufacturer and part number.

ID	Description	Vendor	Part Number	Qty
AC INJ, FB	Header, TH, 100mil, 2x1, Gold plated, 230 mil above insulator	Samtec Inc.	TSW-102-07-G-S	2
P2	Header, TH, 100mil, 3x1, Gold plated, 230 mil above insulator	Samtec Inc.	TSW-103-07-G-S	1
P1	Header, 5-Pin, Dual row, Right Angle, Printed Circuit Board	Samtec Inc.	TSW-105-08-L-D-RA	1
C1, C10	CAP, CERM, 1 uF, 10V, +/-10%, X7R, 0603	MuRata	GRM188R71A105KA61D	2
C3, C4, C5, C6, C7, C8	CAP, CERM, 100 uF, 6.3V, +/-20%, X5R, 1206	MuRata	GRM31CR60J107ME39L	6
C9	CAP, CERM, 0.1 uF, 50V, +/-10%, X7R, 0603	TDK	C1608X7R1H104K	1
C <sub>C1</sub>	CAP, CERM, 2200 pF, 50V, +/-5%, C0G/NP0, 0603	MuRata	GRM1885C1H222JA01D	1
C <sub>C2</sub>	CAP, CERM, 82 pF, 50V, +/-5%, C0G/NP0, 0603	MuRata	GRM1885C1H820JA01D	1
C <sub>C3</sub>	CAP, CERM, 1200 pF, 50V, +/-5%, C0G/NP0, 0603	MuRata	GRM1885C1H122JA01D	1
C <sub>SS</sub>	CAP, CERM, 0.033 uF, 16V, +/-10%, X7R, 0603	MuRata	GRM188R71C333KA01D	1
GND_FI, GND_FO, VIN_F, VOUT_F	Standard Banana Jack, Uninsulated, 15A	Johnson Components	108-0740-001	4
L1	Inductor, Shielded Drum Core, Powdered Iron, 560nH, 27.5A, 0.0018 ohm, SMD	Vishay-Dale	IHLP4040DZERR56M01	1
R1, R2	RES, 1.0 ohm, 5%, 0.1W, 0603	Vishay-Dale	CRCW06031R00JNEA	2
R3, R4, R5, R6	RES, 100 ohm, 1%, 0.1W, 0603	Vishay-Dale	CRCW0603100RFKEA	4
R <sub>EN</sub>	RES, 1M ohm, 5%, 0.1W, 0603	Vishay-Dale	CRCW06031M00JNEA	1
R <sub>AC</sub>	RES, 49.9 ohm, 1%, 0.1W, 0603	Vishay-Dale	CRCW060349R9FKEA	1
R <sub>C1</sub>	RES, 8.25k ohm, 1%, 0.1W, 0603	Vishay-Dale	CRCW06038K25FKEA	1
R <sub>C2</sub>	RES, 113 ohm, 1%, 0.1W, 0603	Vishay-Dale	CRCW0603113RFKEA	1
R <sub>FB1</sub>	RES, 6.81k ohm, 1%, 0.1W, 0603	Vishay-Dale	CRCW06036K81FKEA	1
R <sub>FB2</sub>	RES, 8.06k ohm, 1%, 0.1W, 0603	Vishay-Dale	CRCW06038K06FKEA	1
R <sub>EN1</sub> , R <sub>EN2</sub> , R <sub>PG</sub>	RES, 10 kohm, 5%, 0.1W, 0603	Vishay-Dale	CRCW060310K0JNEA	3
SH-J1, SH-J2, SH-J3	Shunt, 100mil, Gold plated, Black	Samtec Inc.	SNT-100-BK-G	3
U1	15A Buck DC/DC Converter	Texas Instruments	LM21215A-1	1
U2	VID Voltage Programmer for Point of Load Regulator	Texas Instruments	LM10010	1
ENABLE, GND_SI, GND_SO, IDAC, PEN, PGOOD, SS_TRK, SWITCH, SYNC, VDD, VIN_S, VOUT_S	Test Point, TH, Miniature, White	Keystone Electronics	5002	12
H1, H2, H3, H4	Machine Screw, Round, #4-40 x 1/4, Nylon, Philips panhead	B & F Fastener Supply	NY PMS 440 0025 PH	4
H5, H6, H7, H8	Standoff, Hex, 0.5"L #4-40 Nylon	Keystone Electronics	1902C	4

## 12 PCB Layout

The PCB was manufactured with 2oz. copper outer layers, and 1oz. copper inner layers. Twenty 8 mil. diameter vias placed underneath the device, along with additional vias placed throughout the ground plane around the device, help improve the thermal dissipation of the board.

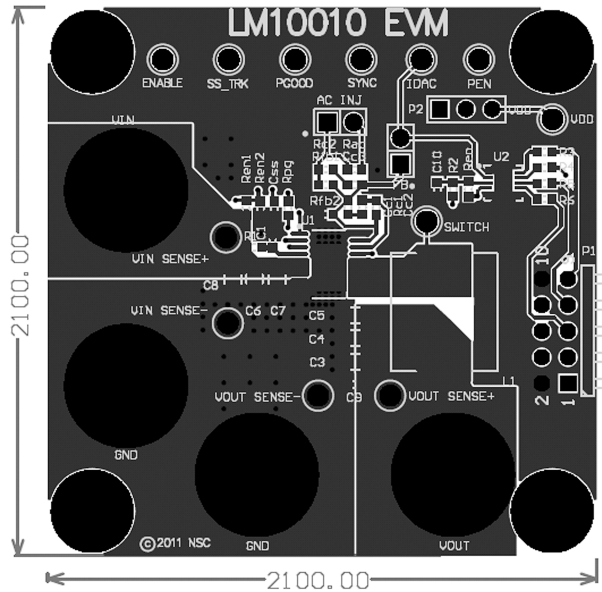

Figure 11. Top Layer (Copper planes outlined in grey)

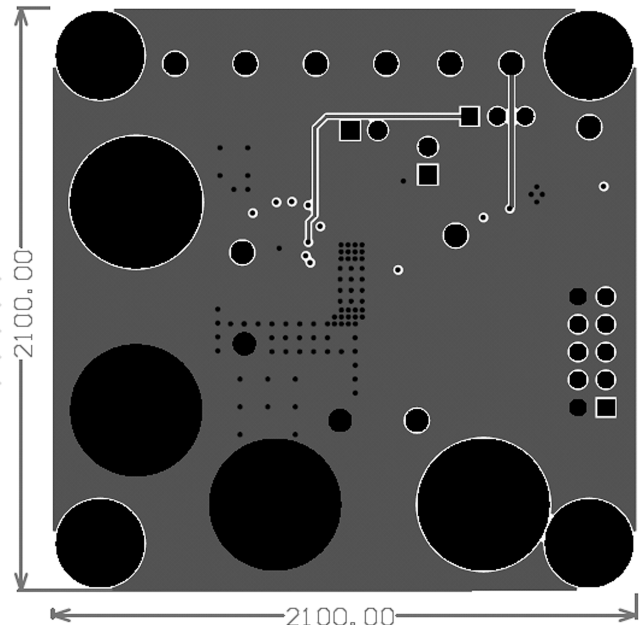

Figure 12. Mid Layer1

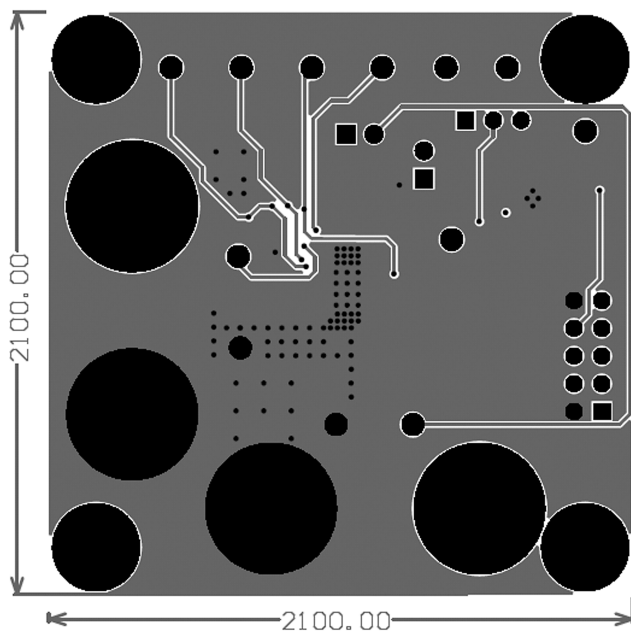

Figure 13. Mid Layer2

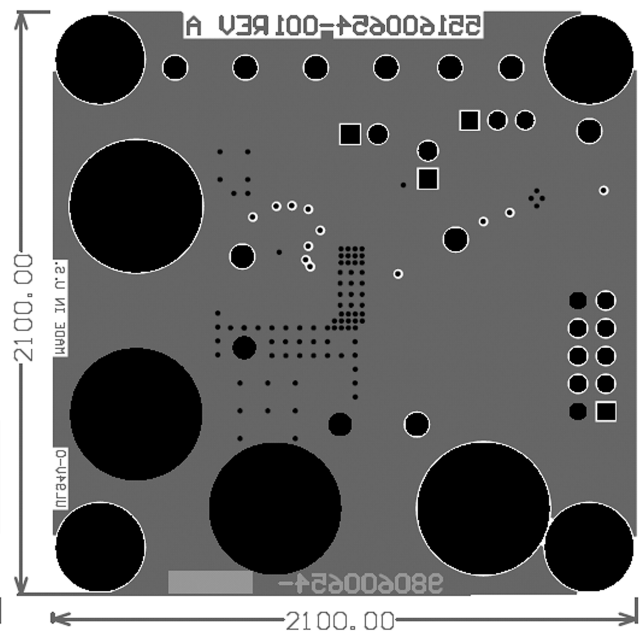

Figure 14. Bottom Layer

## EVALUATION BOARD/KIT/MODULE (EVM) ADDITIONAL TERMS

Texas Instruments (TI) provides the enclosed Evaluation Board/Kit/Module (EVM) under the following conditions:

The user assumes all responsibility and liability for proper and safe handling of the goods. Further, the user indemnifies TI from all claims arising from the handling or use of the goods.

Should this evaluation board/kit not meet the specifications indicated in the User's Guide, the board/kit may be returned within 30 days from the date of delivery for a full refund. THE FOREGOING LIMITED WARRANTY IS THE EXCLUSIVE WARRANTY MADE BY SELLER TO BUYER AND IS IN LIEU OF ALL OTHER WARRANTIES, EXPRESSED, IMPLIED, OR STATUTORY, INCLUDING ANY WARRANTY OF MERCHANTABILITY OR FITNESS FOR ANY PARTICULAR PURPOSE. EXCEPT TO THE EXTENT OF THE INDEMNITY SET FORTH ABOVE, NEITHER PARTY SHALL BE LIABLE TO THE OTHER FOR ANY INDIRECT, SPECIAL, INCIDENTAL, OR CONSEQUENTIAL DAMAGES.

Please read the User's Guide and, specifically, the Warnings and Restrictions notice in the User's Guide prior to handling the product. This notice contains important safety information about temperatures and voltages. For additional information on TI's environmental and/or safety programs, please visit [www.ti.com/esh](http://www.ti.com/esh) or contact TI.

No license is granted under any patent right or other intellectual property right of TI covering or relating to any machine, process, or combination in which such TI products or services might be or are used. TI currently deals with a variety of customers for products, and therefore our arrangement with the user is not exclusive. TI assumes no liability for applications assistance, customer product design, software performance, or infringement of patents or services described herein.

## REGULATORY COMPLIANCE INFORMATION

As noted in the EVM User's Guide and/or EVM itself, this EVM and/or accompanying hardware may or may not be subject to the Federal Communications Commission (FCC) and Industry Canada (IC) rules.

For EVMs **not** subject to the above rules, this evaluation board/kit/module is intended for use for ENGINEERING DEVELOPMENT, DEMONSTRATION OR EVALUATION PURPOSES ONLY and is not considered by TI to be a finished end product fit for general consumer use. It generates, uses, and can radiate radio frequency energy and has not been tested for compliance with the limits of computing devices pursuant to part 15 of FCC or ICES-003 rules, which are designed to provide reasonable protection against radio frequency interference. Operation of the equipment may cause interference with radio communications, in which case the user at his own expense will be required to take whatever measures may be required to correct this interference.

### General Statement for EVMs including a radio

*User Power/Frequency Use Obligations:* This radio is intended for development/professional use only in legally allocated frequency and power limits. Any use of radio frequencies and/or power availability of this EVM and its development application(s) must comply with local laws governing radio spectrum allocation and power limits for this evaluation module. It is the user's sole responsibility to only operate this radio in legally acceptable frequency space and within legally mandated power limitations. Any exceptions to this are strictly prohibited and unauthorized by Texas Instruments unless user has obtained appropriate experimental/development licenses from local regulatory authorities, which is responsibility of user including its acceptable authorization.

### For EVMs annotated as FCC – FEDERAL COMMUNICATIONS COMMISSION Part 15 Compliant

#### Caution

This device complies with part 15 of the FCC Rules. Operation is subject to the following two conditions: (1) This device may not cause harmful interference, and (2) this device must accept any interference received, including interference that may cause undesired operation.

Changes or modifications not expressly approved by the party responsible for compliance could void the user's authority to operate the equipment.

### FCC Interference Statement for Class A EVM devices

This equipment has been tested and found to comply with the limits for a Class A digital device, pursuant to part 15 of the FCC Rules. These limits are designed to provide reasonable protection against harmful interference when the equipment is operated in a commercial environment. This equipment generates, uses, and can radiate radio frequency energy and, if not installed and used in accordance with the instruction manual, may cause harmful interference to radio communications. Operation of this equipment in a residential area is likely to cause harmful interference in which case the user will be required to correct the interference at his own expense.

### **FCC Interference Statement for Class B EVM devices**

This equipment has been tested and found to comply with the limits for a Class B digital device, pursuant to part 15 of the FCC Rules. These limits are designed to provide reasonable protection against harmful interference in a residential installation. This equipment generates, uses and can radiate radio frequency energy and, if not installed and used in accordance with the instructions, may cause harmful interference to radio communications. However, there is no guarantee that interference will not occur in a particular installation. If this equipment does cause harmful interference to radio or television reception, which can be determined by turning the equipment off and on, the user is encouraged to try to correct the interference by one or more of the following measures:

- Reorient or relocate the receiving antenna.
- Increase the separation between the equipment and receiver.
- Connect the equipment into an outlet on a circuit different from that to which the receiver is connected.
- Consult the dealer or an experienced radio/TV technician for help.

### **For EVMs annotated as IC – INDUSTRY CANADA Compliant**

This Class A or B digital apparatus complies with Canadian ICES-003.

Changes or modifications not expressly approved by the party responsible for compliance could void the user's authority to operate the equipment.

### **Concerning EVMs including radio transmitters**

This device complies with Industry Canada licence-exempt RSS standard(s). Operation is subject to the following two conditions: (1) this device may not cause interference, and (2) this device must accept any interference, including interference that may cause undesired operation of the device.

### **Concerning EVMs including detachable antennas**

Under Industry Canada regulations, this radio transmitter may only operate using an antenna of a type and maximum (or lesser) gain approved for the transmitter by Industry Canada. To reduce potential radio interference to other users, the antenna type and its gain should be so chosen that the equivalent isotropically radiated power (e.i.r.p.) is not more than that necessary for successful communication.

This radio transmitter has been approved by Industry Canada to operate with the antenna types listed in the user guide with the maximum permissible gain and required antenna impedance for each antenna type indicated. Antenna types not included in this list, having a gain greater than the maximum gain indicated for that type, are strictly prohibited for use with this device.

Cet appareil numérique de la classe A ou B est conforme à la norme NMB-003 du Canada.

Les changements ou les modifications pas expressément approuvés par la partie responsable de la conformité ont pu vider l'autorité de l'utilisateur pour actionner l'équipement.

### **Concernant les EVMs avec appareils radio**

Le présent appareil est conforme aux CNR d'Industrie Canada applicables aux appareils radio exempts de licence. L'exploitation est autorisée aux deux conditions suivantes : (1) l'appareil ne doit pas produire de brouillage, et (2) l'utilisateur de l'appareil doit accepter tout brouillage radioélectrique subi, même si le brouillage est susceptible d'en compromettre le fonctionnement.

### **Concernant les EVMs avec antennes détachables**

Conformément à la réglementation d'Industrie Canada, le présent émetteur radio peut fonctionner avec une antenne d'un type et d'un gain maximal (ou inférieur) approuvé pour l'émetteur par Industrie Canada. Dans le but de réduire les risques de brouillage radioélectrique à l'intention des autres utilisateurs, il faut choisir le type d'antenne et son gain de sorte que la puissance isotrope rayonnée équivalente (p.i.r.e.) ne dépasse pas l'intensité nécessaire à l'établissement d'une communication satisfaisante.

Le présent émetteur radio a été approuvé par Industrie Canada pour fonctionner avec les types d'antenne énumérés dans le manuel d'usage et ayant un gain admissible maximal et l'impédance requise pour chaque type d'antenne. Les types d'antenne non inclus dans cette liste, ou dont le gain est supérieur au gain maximal indiqué, sont strictement interdits pour l'exploitation de l'émetteur.

## **【Important Notice for Users of this Product in Japan】**

### **This development kit is NOT certified as Confirming to Technical Regulations of Radio Law of Japan**

If you use this product in Japan, you are required by Radio Law of Japan to follow the instructions below with respect to this product:

1. Use this product in a shielded room or any other test facility as defined in the notification #173 issued by Ministry of Internal Affairs and Communications on March 28, 2006, based on Sub-section 1.1 of Article 6 of the Ministry's Rule for Enforcement of Radio Law of Japan,
2. Use this product only after you obtained the license of Test Radio Station as provided in Radio Law of Japan with respect to this product, or
3. Use of this product only after you obtained the Technical Regulations Conformity Certification as provided in Radio Law of Japan with respect to this product. Also, please do not transfer this product, unless you give the same notice above to the transferee. Please note that if you could not follow the instructions above, you will be subject to penalties of Radio Law of Japan.

**Texas Instruments Japan Limited**  
**(address) 24-1, Nishi-Shinjuku 6 chome, Shinjuku-ku, Tokyo, Japan**

<http://www.tij.co.jp>

#### **【ご使用にあたっての注】**

本開発キットは技術基準適合証明を受けておりません。

本製品のご使用に際しては、電波法遵守のため、以下のいずれかの措置を取っていただく必要がありますのでご注意ください。

1. 電波法施行規則第6条第1項第1号に基づく平成18年3月28日総務省告示第173号で定められた電波暗室等の試験設備でご使用いただく。
2. 実験局の免許を取得後ご使用いただく。
3. 技術基準適合証明を取得後ご使用いただく。

なお、本製品は、上記の「ご使用にあたっての注意」を譲渡先、移転先に通知しない限り、譲渡、移転できないものとします。

上記を遵守頂けない場合は、電波法の罰則が適用される可能性があることをご留意ください。

日本テキサス・インスツルメンツ株式会社  
東京都新宿区西新宿6丁目24番1号  
西新宿三井ビル

<http://www.tij.co.jp>

## **EVALUATION BOARD/KIT/MODULE (EVM) WARNINGS, RESTRICTIONS AND DISCLAIMERS**

**For Feasibility Evaluation Only, in Laboratory/Development Environments.** Unless otherwise indicated, this EVM is not a finished electrical equipment and not intended for consumer use. It is intended solely for use for preliminary feasibility evaluation in laboratory/development environments by technically qualified electronics experts who are familiar with the dangers and application risks associated with handling electrical mechanical components, systems and subsystems. It should not be used as all or part of a finished end product.

Your Sole Responsibility and Risk. You acknowledge, represent and agree that:

1. You have unique knowledge concerning Federal, State and local regulatory requirements (including but not limited to Food and Drug Administration regulations, if applicable) which relate to your products and which relate to your use (and/or that of your employees, affiliates, contractors or designees) of the EVM for evaluation, testing and other purposes.
2. You have full and exclusive responsibility to assure the safety and compliance of your products with all such laws and other applicable regulatory requirements, and also to assure the safety of any activities to be conducted by you and/or your employees, affiliates, contractors or designees, using the EVM. Further, you are responsible to assure that any interfaces (electronic and/or mechanical) between the EVM and any human body are designed with suitable isolation and means to safely limit accessible leakage currents to minimize the risk of electrical shock hazard.
3. You will employ reasonable safeguards to ensure that your use of the EVM will not result in any property damage, injury or death, even if the EVM should fail to perform as described or expected.
4. You will take care of proper disposal and recycling of the EVM's electronic components and packing materials.

**Certain Instructions.** It is important to operate this EVM within TI's recommended specifications and environmental considerations per the user guidelines. Exceeding the specified EVM ratings (including but not limited to input and output voltage, current, power, and environmental ranges) may cause property damage, personal injury or death. If there are questions concerning these ratings please contact a TI field representative prior to connecting interface electronics including input power and intended loads. Any loads applied outside of the specified output range may result in unintended and/or inaccurate operation and/or possible permanent damage to the EVM and/or interface electronics. Please consult the EVM User's Guide prior to connecting any load to the EVM output. If there is uncertainty as to the load specification, please contact a TI field representative. During normal operation, some circuit components may have case temperatures greater than 60°C as long as the input and output are maintained at a normal ambient operating temperature. These components include but are not limited to linear regulators, switching transistors, pass transistors, and current sense resistors which can be identified using the EVM schematic located in the EVM User's Guide. When placing measurement probes near these devices during normal operation, please be aware that these devices may be very warm to the touch. As with all electronic evaluation tools, only qualified personnel knowledgeable in electronic measurement and diagnostics normally found in development environments should use these EVMs.

**Agreement to Defend, Indemnify and Hold Harmless.** You agree to defend, indemnify and hold TI, its licensors and their representatives harmless from and against any and all claims, damages, losses, expenses, costs and liabilities (collectively, "Claims") arising out of or in connection with any use of the EVM that is not in accordance with the terms of the agreement. This obligation shall apply whether Claims arise under law of tort or contract or any other legal theory, and even if the EVM fails to perform as described or expected.

**Safety-Critical or Life-Critical Applications.** If you intend to evaluate the components for possible use in safety critical applications (such as life support) where a failure of the TI product would reasonably be expected to cause severe personal injury or death, such as devices which are classified as FDA Class III or similar classification, then you must specifically notify TI of such intent and enter into a separate Assurance and Indemnity Agreement.

Mailing Address: Texas Instruments, Post Office Box 655303, Dallas, Texas 75265  
Copyright © 2013, Texas Instruments Incorporated



## IMPORTANT NOTICE

Texas Instruments Incorporated and its subsidiaries (TI) reserve the right to make corrections, enhancements, improvements and other changes to its semiconductor products and services per JESD46, latest issue, and to discontinue any product or service per JESD48, latest issue. Buyers should obtain the latest relevant information before placing orders and should verify that such information is current and complete. All semiconductor products (also referred to herein as "components") are sold subject to TI's terms and conditions of sale supplied at the time of order acknowledgment.

TI warrants performance of its components to the specifications applicable at the time of sale, in accordance with the warranty in TI's terms and conditions of sale of semiconductor products. Testing and other quality control techniques are used to the extent TI deems necessary to support this warranty. Except where mandated by applicable law, testing of all parameters of each component is not necessarily performed.

TI assumes no liability for applications assistance or the design of Buyers' products. Buyers are responsible for their products and applications using TI components. To minimize the risks associated with Buyers' products and applications, Buyers should provide adequate design and operating safeguards.

TI does not warrant or represent that any license, either express or implied, is granted under any patent right, copyright, mask work right, or other intellectual property right relating to any combination, machine, or process in which TI components or services are used. Information published by TI regarding third-party products or services does not constitute a license to use such products or services or a warranty or endorsement thereof. Use of such information may require a license from a third party under the patents or other intellectual property of the third party, or a license from TI under the patents or other intellectual property of TI.

Reproduction of significant portions of TI information in TI data books or data sheets is permissible only if reproduction is without alteration and is accompanied by all associated warranties, conditions, limitations, and notices. TI is not responsible or liable for such altered documentation. Information of third parties may be subject to additional restrictions.

Resale of TI components or services with statements different from or beyond the parameters stated by TI for that component or service voids all express and any implied warranties for the associated TI component or service and is an unfair and deceptive business practice. TI is not responsible or liable for any such statements.

Buyer acknowledges and agrees that it is solely responsible for compliance with all legal, regulatory and safety-related requirements concerning its products, and any use of TI components in its applications, notwithstanding any applications-related information or support that may be provided by TI. Buyer represents and agrees that it has all the necessary expertise to create and implement safeguards which anticipate dangerous consequences of failures, monitor failures and their consequences, lessen the likelihood of failures that might cause harm and take appropriate remedial actions. Buyer will fully indemnify TI and its representatives against any damages arising out of the use of any TI components in safety-critical applications.

In some cases, TI components may be promoted specifically to facilitate safety-related applications. With such components, TI's goal is to help enable customers to design and create their own end-product solutions that meet applicable functional safety standards and requirements. Nonetheless, such components are subject to these terms.

No TI components are authorized for use in FDA Class III (or similar life-critical medical equipment) unless authorized officers of the parties have executed a special agreement specifically governing such use.

Only those TI components which TI has specifically designated as military grade or "enhanced plastic" are designed and intended for use in military/aerospace applications or environments. Buyer acknowledges and agrees that any military or aerospace use of TI components which have **not** been so designated is solely at the Buyer's risk, and that Buyer is solely responsible for compliance with all legal and regulatory requirements in connection with such use.

TI has specifically designated certain components as meeting ISO/TS16949 requirements, mainly for automotive use. In any case of use of non-designated products, TI will not be responsible for any failure to meet ISO/TS16949.

### Products

Audio	<a href="http://www.ti.com/audio">www.ti.com/audio</a>
Amplifiers	<a href="http://amplifier.ti.com">amplifier.ti.com</a>
Data Converters	<a href="http://dataconverter.ti.com">dataconverter.ti.com</a>
DLP® Products	<a href="http://www.dlp.com">www.dlp.com</a>
DSP	<a href="http://dsp.ti.com">dsp.ti.com</a>
Clocks and Timers	<a href="http://www.ti.com/clocks">www.ti.com/clocks</a>
Interface	<a href="http://interface.ti.com">interface.ti.com</a>
Logic	<a href="http://logic.ti.com">logic.ti.com</a>
Power Mgmt	<a href="http://power.ti.com">power.ti.com</a>
Microcontrollers	<a href="http://microcontroller.ti.com">microcontroller.ti.com</a>
RFID	<a href="http://www.ti-rfid.com">www.ti-rfid.com</a>
OMAP Applications Processors	<a href="http://www.ti.com/omap">www.ti.com/omap</a>
Wireless Connectivity	<a href="http://www.ti.com/wirelessconnectivity">www.ti.com/wirelessconnectivity</a>

### Applications

Automotive and Transportation	<a href="http://www.ti.com/automotive">www.ti.com/automotive</a>
Communications and Telecom	<a href="http://www.ti.com/communications">www.ti.com/communications</a>
Computers and Peripherals	<a href="http://www.ti.com/computers">www.ti.com/computers</a>
Consumer Electronics	<a href="http://www.ti.com/consumer-apps">www.ti.com/consumer-apps</a>
Energy and Lighting	<a href="http://www.ti.com/energy">www.ti.com/energy</a>
Industrial	<a href="http://www.ti.com/industrial">www.ti.com/industrial</a>
Medical	<a href="http://www.ti.com/medical">www.ti.com/medical</a>
Security	<a href="http://www.ti.com/security">www.ti.com/security</a>
Space, Avionics and Defense	<a href="http://www.ti.com/space-avionics-defense">www.ti.com/space-avionics-defense</a>
Video and Imaging	<a href="http://www.ti.com/video">www.ti.com/video</a>

### TI E2E Community

[e2e.ti.com](http://e2e.ti.com)