

# **TMS320DM35x**

## **Digital Media System-on-Chip (DMSoC)**

### **Video Processing Front End (VPFE)**

## **Reference Guide**



Literature Number: SPRUF71A  
December 2007–Revised June 2008



<b>Preface</b> .....	<b>17</b>
<b>1 Video Processing Front End Overview</b> .....	<b>20</b>
1.1 Purpose of the Video Processing Front End.....	21
1.2 Features.....	22
1.3 Functional Block Diagram.....	25
1.4 Supported Use Case Statement.....	25
1.5 Industry Standard(s) Compliance Statement.....	26
<b>2 VPFE/ISP I/O Interfacing</b> .....	<b>26</b>
2.1 Parallel Generic Interface Configuration (RAW).....	27
2.2 ITU-R BT.656 Interface Configuration.....	32
2.3 Generic YCbCr Interface Configuration.....	35
2.4 VPFE I/O Multiplexing.....	37
<b>3 VPFE/ISP Integration</b> .....	<b>40</b>
3.1 Clocking, Reset and Power Management Scheme.....	40
3.2 Hardware Requests.....	41
3.3 VPSS Top-Level Register Mapping Summary.....	42
3.4 VPFE/ISP Top-Level Signal Interaction.....	42
<b>4 VPFE/ISP Functional Description</b> .....	<b>43</b>
4.1 CCD/CMOS Controller (CCDC).....	43
4.2 Image Pipe Interface (IPIPEIF).....	56
4.3 Image Pipe (IPIPE).....	60
4.4 Statistics Collection - Hardware 3A (H3A).....	81
4.5 VPFE Arbitration and Data Transfer Control (VPSSBL).....	81
<b>5 Programming Model</b> .....	<b>83</b>
5.1 Setup for Typical Configuration.....	83
5.2 Resetting the Camera Subsystem.....	83
5.3 Configuring the Clocks and the Control Signals.....	83
5.4 Programming the CCD/CMOS Controller (CCDC).....	83
5.5 Programming the Image Pipe Interface (IPIPEIF).....	88
5.6 Programming the Image Pipe (IPIPE).....	91
5.7 Programming the Hardware 3A (H3A).....	108
5.8 Programming the Buffer Logic (VPSSBL and VPSSCLK Registers).....	111
<b>6 Registers</b> .....	<b>113</b>
6.1 CCD Controller (CCDC) Registers.....	113
6.2 Image Pipe Input Interface Registers (IPIPEIF).....	156
6.3 Image Pipe Registers (IPIPE).....	164
6.4 Hardware 3A Registers (H3A).....	239
6.5 VPSS Buffer Logic Registers (VPSSBL).....	262
6.6 VPSS Clock Control Registers (VPSSCLK).....	269
<b>Appendix A Revision History</b> .....	<b>271</b>

## List of Figures

1	Functional Block Diagram .....	20
2	Video Processing Subsystem (VPSS) Block Diagram .....	21
3	Video Processing Front End (VPFE) Block Diagram and Data Flows .....	25
4	Raw Mode Timing Diagram .....	31
5	DDR2/mDDR controller Output Format .....	31
6	BT.656 Signal Interface .....	33
7	BT.656 Mode Data Format in SDRAM .....	34
8	Pin Mux 0 Register (PINMUX0) .....	38
9	Video Processing Front End (VPFE) Block Diagram .....	43
10	CCD Controller – Top Level Block Diagram .....	43
11	CCD Controller – Input Formatting .....	44
12	CCD Controller Color Patterns .....	44
13	CCD/CMOS Controller RAW Data Processing Flow .....	45
14	CCD Controller Optical Black Averaging and Application .....	46
15	Color Space Converter Functional Block Diagram .....	46
16	Color Space Converter Operation .....	47
17	Color Space Converter Operation .....	47
18	Color Space Conversion .....	47
19	First Pixel/First Line Generation .....	48
20	Second Pixel/First Line Generation .....	48
21	Second Last Pixel/First Line Generation .....	48
22	Last Pixel/First Line Generation .....	48
23	First Pixel/Last Line Generation .....	49
24	Second Pixel/Last Line Generation .....	49
25	Second Last Pixel/Last Line Generation .....	49
26	Last Pixel/Last Line Generation .....	49
27	Output Formatter Functional Model .....	50
28	A-Law Table .....	51
29	Example for Decimation Pattern .....	52
30	SDRAM Output Format .....	52
31	CCD/CMOS Controller YCbCr Data Processing Flow .....	53
32	Frame Image Format Conversion .....	54
33	Example Formats of Input and Output Image .....	55
34	Image Pipe Interface Processing Flow .....	56
35	Global Frame Definition in SDRAM Input Modes (except Darkframe) .....	57
36	Global Frame Definition in Darkframe Subtract Mode .....	58
37	Image Pipe Processing Flow .....	60
38	CFA Arrangements .....	60
39	Processing Area Within Global Frame .....	62
40	Defect Information Packet .....	63
41	Numbering in Defect Correction Algorithm .....	63
42	Defect Correction Functional Model .....	64
43	Mirroring in Defect Correction and Noise Filter .....	64
44	Noise Filter Array .....	64
45	CFA Interpolation Functional Model .....	65
46	Gamma Correction Functional Model .....	66
47	Example of Gamma Curve .....	66
48	ROM Gamma Table .....	67
49	RGB2YCbCr Conversion Functional Model .....	67
50	Chroma Sub-Sampling Position .....	68
51	4:2:2 Conversion Functional Model .....	68
52	Horizontal Resize Functional Model .....	70

53	Output Interface Functional Model .....	71
54	RGB Data Format .....	72
55	Linear Buffer .....	73
56	Ring Buffer .....	74
57	Data Flipping Mode .....	74
58	Write Start Address at Each Flipping Mode .....	75
59	Output Data Format to SDRAM .....	75
60	Boxcar Operation (8 × 8 block) .....	76
61	Boxcar Data Packing in SDRAM .....	77
62	Histogram Processing Flow .....	78
63	Region Priority .....	80
64	VPFE Shared Memories and Multiplexers .....	82
65	VPFE Data Flow Diagram .....	83
66	VDINT0/VDINT1 Interrupt Behavior When VDPOL = 0 .....	87
67	VDINT0/VDINT1 Interrupt Behavior When VDPOL = 1 .....	87
68	VDINT2 Interrupt Behavior .....	87
69	Interrupt Timing When Resized Area = Resize Frame .....	98
70	Interrupt Timing When Resized Area < Resize Frame .....	99
71	Lateral Overhead Pixels .....	100
72	Vertical Overhead Pixels .....	101
73	Frame Division Mode - V .....	102
74	Register Settings for Frame Division Mode - V .....	103
75	Frame Division Mode - H .....	104
76	Blocks in Frame Division Mode - H .....	104
77	Register Settings for Frame Division Mode - H .....	105
78	Register Settings for Frame Division Mode - H .....	106
79	Memory Settings for Frame Division Mode - H .....	107
80	Synchronization Enable Register (SYNCEN) .....	115
81	Mode Setup Register (MODESET) .....	116
82	HD Pulse Width Register (HDWIDTH) .....	118
83	VD Pulse Width Register (VDWIDTH) .....	118
84	Pixels Per Line Register (PPLN) .....	119
85	Lines Per Frame Register (LPFR) .....	119
86	Start Pixel Horizontal Register (SPH) .....	120
87	Number of Pixels Horizontal Register (NPH) .....	120
88	Start Line Vertical - Field 0 Register (SLV0) .....	121
89	Start Line Vertical - Field 1 Register (SLV1) .....	121
90	Number of Lines Vertical Register (NLV) .....	122
91	Culling Horizontal Register (CULH) .....	122
92	Culling Vertical Register (CULV) .....	123
93	Horizontal Size Register (HSIZE) .....	123
94	SDRAM Line Offset Register (SDOFST) .....	124
95	SDRAM Address - High Register (STADRH) .....	125
96	SDRAM Address - Low Register (STADRL) .....	126
97	CCD Data Clamping Register (CLAMP) .....	126
98	DC Clamp Register (DCSUB) .....	127
99	CCD Color Pattern Register (COLPTN) .....	127
100	Black Compensation #1 Register (BLKCMP0) .....	129
101	Black Compensation #2 Register (BLKCMP1) .....	129
102	CCD Median Filter Register (MEDFILT) .....	130
103	CCD Gain Adjustment - R/Ye Register (RYEGAIN) .....	130
104	CCD Gain Adjustment - Gr/Cy Register (GRCYGAIN) .....	131
105	CCD gain adjustment - Gb/G register (GBGGAIN) .....	131

106	CCD Gain Adjustment - B/Mg Register (BMGGAIN).....	132
107	CCD Offset Adjustment Register (OFFSET) .....	132
108	Output Clipping Value Register (OUTCLIP).....	133
109	VD Interrupt #0 Register (VDINT0).....	133
110	VD Interrupt #1 Register (VDINT1).....	133
111	Gamma Correction Settings Register (GAMMAWD).....	134
112	REC656 Control Register (REC656IF).....	135
113	CCD Configuration Register (CCDCFG).....	136
114	Start Pixel Horizontal Register (FMTSPH) .....	137
115	Number Of Pixels Register (FMTLNH).....	137
116	Start Line Vertical Register (FMTSLV).....	138
117	Number of Lines Register (FMTLNV) .....	138
118	Lens Shading Correction Configuration 1 Register (LSCCFG1) .....	139
119	Lens Shading Correction Configuration 2 Register (LSCCFG2) .....	140
120	Lens Shading Correction - Center Position (H0) Register (LSCH0) .....	141
121	Lens Shading Correction - Center Position (V0) Register (LSCV0).....	141
122	Lens Shading Correction - Horizontal Coefficients Register (LSCKH) .....	142
123	Lens Shading Correction - Vertical Coefficients Register (LSCKV).....	142
124	Lens Shading Correction - Memory Control Register (LSCMEMCTL).....	143
125	Lens Shading Correction - Memory Write Data Register (LSCMEMD).....	144
126	Lens Shading Correction - Memory Read Data Register (LSCMEMQ) .....	144
127	Defect Correction - Control Register (DFCCTL).....	145
128	Defect Correction - Vertical Saturation Level Register (DFCVSAT) .....	146
129	Defect Correction - Memory Control Register (DFCMEMCTL) .....	147
130	Defect Correction - Set V Position Register (DFCMEM0) .....	148
131	Defect Correction - Set H Position Register (DFCMEM1).....	148
132	Defect Correction - Set SUB1 Register (DFCMEM2) .....	149
133	Defect Correction - Set SUB2 Register (DFCMEM3) .....	149
134	Defect Correction - Set SUB3 Register (DFCMEM4) .....	150
135	Color Space Converter Enable Register (CSCCTL) .....	150
136	Color Space Converter - Coefficients #0 Register (CSCM0) .....	151
137	Color Space Converter - Coefficients #1 Register (CSCM1) .....	151
138	Color Space Converter - Coefficients #2 Register (CSCM2) .....	152
139	Color Space Converter - Coefficients #3 Register (CSCM3) .....	152
140	Color Space Converter - Coefficients #4 Register (CSCM4) .....	153
141	Color Space Converter - Coefficients #5 Register (CSCM5) .....	153
142	Color Space Converter - Coefficients #6 Register (CSCM6) .....	154
143	Color Space Converter - Coefficients #7 Register (CSCM7) .....	154
144	Data Offset Register (DATAOFST).....	155
145	IPIPE I/F Enable Register (ENABLE) .....	156
146	IPIPE I/F Configuration Register (CFG) .....	157
147	PIPE I/F Interval of HD / Start pixel in HD Register (PPLN) .....	159
148	IPIPE I/F Interval of VD / Start line in VD Register (LPFR) .....	159
149	IPIPE I/F Number of valid pixels per line Register (HNUM).....	160
150	IPIPE I/F Number of Valid Lines per Frame Register (VNUM) .....	160
151	IPIPE I/F Memory Address (Upper) Register (ADDRU) .....	161
152	IPIPE I/F Memory Address (Lower) Register (ADDRL).....	161
153	IPIPE I/F Address Offset of Each Line Register (ADOFS) .....	162
154	IPIPE I/F Horizontal Resizing Parameter Register (RSZ) .....	162
155	IPIPE I/F Gain Parameter Register (GAIN) .....	163
156	IPIPE Enable Register (IPIPE_EN).....	169
157	One Shot Mode Register (IPIPE_MODE) .....	169
158	Input/Output Data Paths Register (IPIPE_DPATHS) .....	170

159	Color Pattern Register (IPIPE_COLPAT).....	171
160	Vertical Start Position Register (IPIPE_VST) .....	172
161	Vertical Processing Size Register (IPIPE_VSZ) .....	172
162	Horizontal Start Position Register (IPIPE_HST) .....	173
163	Horizontal Processing Size Register (IPIPE_HSZ).....	173
164	ARM Gated Clock Control Register (GCL_ARM).....	174
165	CCD Gated Clock Control Register (GCL_CCD).....	174
166	SDR Gated Clock Control Register (GCL_SDR) .....	176
167	Internal Table Selection Register (RAM_MODE).....	177
168	Address Register (RAM_ADR).....	178
169	Write Data Register (RAM_WDT) .....	178
170	Read Data Register (RAM_RDT).....	178
171	Interrupt Enable Register (IRQ_EN).....	179
172	Interval of IRQ-2 Register (IRQ_RZA) .....	180
173	Interval of IRQ-3 Register (IRQ_RZB) .....	180
174	Defect Correction Enable Register (DFC_EN).....	181
175	Copy Method Selection (from Top or from Bottom) Register (DFC_SEL) .....	181
176	Start Address in LUT Register (DFC_ADR).....	182
177	Number of Available Entries in LUT Register (DFC_SIZ) .....	182
178	2D Noise Filter Enable Register (D2F_EN) .....	183
179	Noise Filter Configuration Register (D2F_CFG).....	183
180	Noise Filter LUT Values (Threshold) Register (D2F_THR[32]).....	184
181	Noise Filter LUT Values (Intensity) Register (D2F_STR[32]).....	184
182	PreFilter Enable Register (PRE_EN).....	185
183	PreFilter Type Register (PRE_TYP).....	185
184	Shift Value of Adaptive Gain Register (PRE_SHF) .....	186
185	Constant Gain or Adaptive Gain Slope Register (PRE_GAIN) .....	186
186	Threshold G Register (PRE_THR_G).....	187
187	Threshold B Register (PRE_THR_B) .....	187
188	Threshold 1 Register (PRE_THR_1).....	188
189	Digital Gain Register (WB2_DGN) .....	188
190	White Balance Gain (Red) Register (WB2_WG_R).....	189
191	White Balance Gain (Gr) Register (WB2_WG_GR).....	189
192	White Balance Gain (Gb) Register (WB2_WG_GB) .....	190
193	White Balance Gain (Blue) Register (WB2_WG_B).....	190
194	Matrix Coefficient RR Register (RGB_MUL_RR).....	191
195	Matrix Coefficient GR Register (RGB_MUL_GR) .....	191
196	Matrix Coefficient BR Register (RGB_MUL_BR) .....	192
197	Matrix Coefficient RG Register (RGB_MUL_RG) .....	192
198	Matrix Coefficient GG Register (RGB_MUL_GG) .....	193
199	Matrix Coefficient BG Register (RGB_MUL_BG).....	193
200	Matrix Coefficient RB Register (RGB_MUL_RB) .....	194
201	Matrix Coefficient GB Register (RGB_MUL_GB).....	194
202	Matrix Coefficient BB Register (RGB_MUL_BB) .....	195
203	R Output Offset Register (RGB_OFT_OR).....	195
204	G Output Offset Register (RGB_OFT_OG) .....	196
205	B Output Offset Register (RGB_OFT_OB).....	196
206	Gamma Correction Configuration Register (GMM_CFG) .....	197
207	Luminance Adjustment (Contrast and Brightness) Register (YCC_ADJ) .....	198
208	Matrix Coefficient RY Register (YCC_MUL_RY) .....	198
209	Matrix Coefficient GY Register (YCC_MUL_GY).....	199
210	Matrix Coefficient BY Register (YCC_MUL_BY).....	199
211	Matrix Coefficient RCb Register (YCC_MUL_RCB).....	200

212	Matrix Coefficient GCb Register (YCC_MUL_GCB) .....	200
213	Matrix Coefficient BCb Register (YCC_MUL_BCB) .....	201
214	Matrix Coefficient RCr Register (YCC_MUL_RCR) .....	201
215	Matrix Coefficient GCr Register (YCC_MUL_GCR) .....	202
216	Matrix Coefficient BCr Register (YCC_MUL_BCR) .....	202
217	Y Output Offset Register (YCC_OFT_Y) .....	203
218	Cb Output Offset Register (YCC_OFT_CB) .....	203
219	Cr Output Offset Register (YCC_OFT_CR) .....	204
220	Saturation (Luminance Minimum) Register (YCC_Y_MIN) .....	204
221	Saturation (Luminance Maximum) Register (YCC_Y_MAX) .....	205
222	Saturation (Chrominance Minimum) Register (YCC_C_MIN) .....	205
223	Saturation (Chrominance Maximum) Register (YCC_C_MAX) .....	206
224	Chrominance Position (for 422 Down Sampler) Register (YCC_PHS) .....	206
225	Edge Enhancer Enable Register (YEE_EN) .....	207
226	MedianNR Enable Register (YEE_EMF) .....	207
227	HPF Shift Length Register (YEE_SHF) .....	208
228	HPF Coefficient 00 Register (YEE_MUL_00) .....	208
229	HPF Coefficient 01 Register (YEE_MUL_01) .....	209
230	HPF Coefficient 02 Register (YEE_MUL_02) .....	209
231	HPF Coefficient 10 Register (YEE_MUL_10) .....	210
232	HPF Coefficient 11 Register (YEE_MUL_11) .....	210
233	HPF Coefficient 12 Register (YEE_MUL_12) .....	211
234	HPF Coefficient 20 Register (YEE_MUL_20) .....	211
235	HPF Coefficient 21 Register (YEE_MUL_21) .....	212
236	HPF Coefficient 22 Register (YEE_MUL_22) .....	212
237	Fault Color Suppression Enable Register (FCS_EN) .....	213
238	Type selection of HPF Register (FCS_TYP) .....	213
239	Down Shift Size (HPF) Register (FCS_SHF_Y) .....	214
240	Down Shift Size (GAIN) Register (FCS_SHF_C) .....	214
241	Threshold Register (FCS_THR) .....	215
242	Intensity Register (FCS_SGN) .....	215
243	Lower Limit of Chroma Gain Register (FCS_LTH) .....	215
244	Processing Mode Register (RSZ_SEQ) .....	216
245	Vertical Anti aliasing Filter Register (RSZ_AAL) .....	217
246	Resizer Enable Register (RSZ_EN) .....	217
247	One Shot Mode Register (RSZ_MODE) .....	218
248	Vertical Start Position of the Input Register (RSZ_I_VST) .....	218
249	Vertical Size of the Input Register (RSZ_I_VSZ) .....	219
250	Horizontal Start Position of the Input Register (RSZ_I_HST) .....	219
251	Vertical Size of the Output Register (RSZ_O_VSZ) .....	220
252	Horizontal Start Position of the Output Register (RSZ_O_HST) .....	220
253	Horizontal Size of the Output Register (RSZ_O_HSZ) .....	221
254	Initial Phase of Vertical Resizing Process Register (RSZ_V_PHS) .....	221
255	Phase of Last Value in Previous Resize Process Register (RSZ_V_PHS_O) .....	222
256	Vertical Resize Parameter Register (RSZ_V_DIF) .....	222
257	Actual Number of Output Lines Register (RSZ_V_SIZ_O) .....	223
258	Initial Phase of Horizontal Resizing Process Register (RSZ_H_PHS) .....	223
259	Horizontal Resize Parameter Register (RSZ_H_DIF) .....	224
260	Interpolation Method for Horizontal Rescaling Register (RSZ_H_TYP) .....	224
261	Selection of Horizontal LPF Intensity Register (RSZ_H_LSE) .....	225
262	Horizontal LPF Intensity Register (RSZ_H_LPF) .....	225
263	RGB Output Enable Register (RSZ_RGB_EN) .....	226
264	RGB Output Bit Mode (32 or 16 bit) Register (RSZ_RGB_TYP) .....	226



265	YC422 to YC444 Conversion Method Register (RSZ_RGB_BLD).....	227
266	SDRAM Base Address MSB Register (RSZ_SDR_BAD_H).....	227
267	SDRAM Base Address LSB Register (RSZ_SDR_BAD_L).....	228
268	SDRAM Start Address MSB Register (RSZ_SDR_SAD_H).....	228
269	SDRAM Start Address LSB Register (RSZ_SDR_SAD_L).....	229
270	SDRAM Line Offset Register (RSZ_SDR_OFT).....	229
271	Start Line of SDRAM Pointer Register (RSZ_SDR_PTR_S).....	230
272	End Line of SDRAM Pointer Register (RSZ_SDR_PTR_E).....	231
273	Output of Current Pointer Value (Read Only) Register (RSZ_SDR_PTR_O).....	232
274	Boxcar Enable Register (BOX_EN).....	232
275	One Shot Mode Register (BOX_MODE).....	233
276	Block Size (16x16 or 8x8) Register (BOX_TYP).....	233
277	Down Shift Value of Input Register (BOX_SHF).....	234
278	Histogram Enable Register (HST_EN).....	234
279	One Shot Mode Register (HST_MODE).....	235
280	Histogram Source Select Register (HST_SEL).....	235
281	Histogram Parameters Select Register (HST_PARA).....	236
282	Vertical Start Position Register (HST_VST).....	237
283	Vertical Size Register (HST_VSZ).....	237
284	Horizontal Start Position Register (HST_HST).....	237
285	Horizontal Size Register (HST_HSZ).....	238
286	Peripheral Revision and Class Information Register (PID).....	240
287	Peripheral Control Register (PCR).....	241
288	Setup for the AF Engine Poxel Configuration Register (AFPAX1).....	243
289	Setup for the AF Engine Poxel Configuration Register (AFPAX2).....	244
290	Start Position for AF Engine Poxels Register (AFPAXSTART).....	245
291	Start Position for IIRSH Register (AFIIRSH).....	246
292	SDRAM/DDRAM Start Address for AF Engine Register (AFBUFST).....	246
293	IIR Filter Coefficient Data for SET 0 Register (AFCOEF010).....	247
294	IR Filter Coefficient Data for Set 0 Register (AFCOEF032).....	247
295	IIR Filter Coefficient Data for SET 0 Register (AFCOEFF054).....	248
296	IIR Filter Coefficient Data for SET 0 Register (AFCOEFF076).....	248
297	IIR Filter Coefficient Data for SET 0 Register (AFCOEFF098).....	249
298	IIR Filter Coefficient Data for SET 0 Register (AFCOEFF0010).....	249
299	IIR Filter Coefficient Data for SET 1 Register (AFCOEF110).....	251
300	IIR Filter Coefficient Data for SET 1 Register (AFCOEF132).....	251
301	IIR Filter Coefficient Data for SET 1 Register (AFCOEFF154).....	252
302	IIR Filter Coefficient Data for SET 1 Register (AFCOEFF176).....	252
303	IIR Filter Coefficient Data for SET 1 Register (AFCOEFF198).....	253
304	IIR Filter Coefficient Data for SET 1 Register (AFCOEFF1010).....	253
305	Configuration for AE/AWB Windows Register (AEWWIN1).....	255
306	Start Position for AE/AWB Windows Register (AEWINSTART).....	256
307	Start Position and Height for Black Line of AE/AWB Windows Register (AEWINBLK).....	257
308	Configuration for Subsample Data in AE/AWB Window Register (AEWSUBWIN).....	258
309	SDRAM/DDRAM Start Address for AE/AWB Engine Output Data Register (AEWBUFST).....	259
310	SDRAM/DDRAM Read Address for AE/AWB Engine Register (RSDR_ADDR).....	259
311	Line Offset for the Read Data Register (RADR_OFFSET).....	260
312	Frame Size for SDRAM Read Data Register (SDR_FRSIZE).....	261
313	Peripheral Revision and Class Information Register (PID).....	262
314	Peripheral Control Register (PCR).....	263
315	Interrupt Status Register (INTSTAT).....	264
316	Interrupt Selection Register (INTSEL).....	266
317	Event Selection Register (EVTSEL).....	267

---

318	Shared Memory Master Select Register (MEMCTRL) .....	268
319	Peripheral Revision and Class Information Register (PID).....	269
320	VPSS Clock Control Register (CLKCTRL) .....	270

## List of Tables

1	Interface Signals for Video Processing Front End .....	26
2	Interface Signals for Parallel Raw Mode .....	27
3	Imager Data Connection Examples .....	28
4	Available Gain Functions for Bit Shifting the Data .....	28
5	CCD/CMOS Interface Signals .....	29
6	Interface Signals for ITU-R BT.656 Mode.....	32
7	ITU-R BT.656 Interface Signals .....	33
8	Video Timing Reference Codes for SAV and EAV .....	34
9	F, V, H Signal Descriptions .....	34
10	F, V, H Protection (Error Correction) Bits .....	34
11	Interface Signals for Generic YCbCr Mode .....	35
12	Table 16. YCbCr Interface Signals.....	36
13	DDR2/mDDR Controller Storage Format for YCbCr Processing .....	36
14	Signals for VPFE Digital Capture Modes .....	37
15	Pin Mux 0 Register (PINMUX0) Field Descriptions .....	38
16	Clock Domains.....	40
17	VPSS Events .....	41
18	ARM Interrupts - VPSS .....	41
19	EDMA Events - VPSS .....	42
20	VPFE Module Register Map .....	42
21	YCbCr Mode SDRAM Output Format .....	53
22	Available Processing for Input Modes .....	61
23	Label Descriptions From Figure 39 .....	62
24	YcbCr-422 Memory Format .....	70
25	SDRAM Write Registers .....	73
26	Recommended SHIFT Values to Get 16-Bit Output Resolution .....	77
27	Regions and Bins for Histogram .....	79
28	Recommended SHIFT Values .....	80
29	VPFE Memory Master Selection .....	82
30	CCDC Required Configuration Parameters .....	84
31	CCDC Conditional Configuration Parameters .....	84
32	IPIPE Interface Required Configuration Parameters .....	89
33	Table 52. IPIPE Interface Conditional Configuration Parameters .....	89
34	IPIPE Required Configuration Parameters .....	91
35	IPIPE Conditional Configuration Parameters .....	92
36	IPIPE Events .....	98
37	IPIPE Resizer Status Registers .....	99
38	AF Engine Required Configuration Parameters .....	108
39	AF Engine Conditional Configuration Parameters .....	108
40	AEW Engine Required Configuration Parameters .....	109
41	AEW Engine Conditional Configuration Parameters .....	109
42	VPSSBL and VPSSCLK Required Configuration Parameters .....	111
43	Video Processing Front End Sub-Module Register Map .....	113
44	CCD Controller (CCDC) Registers .....	113
45	Synchronization Enable Register (SYNCEN) Field Descriptions.....	115
46	Mode Setup Register (MODESET) Field Descriptions.....	116
47	HD Pulse Width Register (HDWIDTH) Field Descriptions.....	118
48	VD Pulse Width Register (VDWIDTH) Field Descriptions .....	118
49	Pixels Per Line Register (PPLN) Field Descriptions .....	119

50	Lines Per Frame Register (LPFR) Field Descriptions.....	119
51	Start Pixel Horizontal Register (SPH) Field Descriptions.....	120
52	Number of Pixels Horizontal Register (NPH) Field Descriptions .....	120
53	Start Line Vertical - Field 0 Register (SLV0) Field Descriptions .....	121
54	Start Line Vertical - Field 1 Register (SLV1) Field Descriptions.....	121
55	Number of Lines Vertical Register (NLV) Field Descriptions.....	122
56	Culling Horizontal Register (CULH) Field Descriptions .....	122
57	Culling Vertical Register (CULV) Field Descriptions .....	123
58	Horizontal Size Register (HSIZE) Field Descriptions .....	123
59	SDRAM Line Offset Register (SDOFST) Field Descriptions .....	124
60	SDRAM Address - High Register (STADRH) Field Descriptions .....	125
61	SDRAM Address - Low Register (STADRL) Field Descriptions .....	126
62	CCD Data Clamping Register (CLAMP) Field Descriptions.....	126
63	DC Clamp Register (DCSUB) Field Descriptions.....	127
64	CCD Color Pattern Register (COLPTN) Field Descriptions .....	127
65	Black Compensation #1 Register (BLKCMP0) Field Descriptions .....	129
66	Black Compensation #2 Register (BLKCMP1) Field Descriptions .....	129
67	CCD Median Filter Register (MEDFILT) Field Descriptions.....	130
68	CCD Gain Adjustment - R/Ye Register (RYEGAIN) Field Descriptions .....	130
69	CCD Gain Adjustment - Gr/Cy Register (GRCYGAIN) Field Descriptions .....	131
70	CCD gain adjustment - Gb/G register (GBGGAIN) Field Descriptions .....	131
71	CCD Gain Adjustment - B/Mg Register (BMGGAIN) Field Descriptions .....	132
72	CCD Offset Adjustment Register (OFFSET) Field Descriptions.....	132
73	Output Clipping Value Register (OUTCLIP) Field Descriptions .....	133
74	VD Interrupt #0 Register (VDINT0) Field Descriptions .....	133
75	VD Interrupt #1 Register (VDINT1) Field Descriptions .....	133
76	Gamma Correction Settings Register (GAMMAWD) Field Descriptions .....	134
77	REC656 Control Register (REC656IF) Field Descriptions .....	135
78	CCD Configuration Register (CCDCFG) Field Descriptions .....	136
79	Start Pixel Horizontal Register (FMTSPH) Field Descriptions .....	137
80	Number Of Pixels Register (FMTLNH) Field Descriptions .....	137
81	Start Line Vertical Register (FMTSLV) Field Descriptions .....	138
82	Number of Lines Register (FMTLNV) Field Descriptions.....	138
83	Lens Shading Correction Configuration 1 Register (LSCCFG1) Field Descriptions .....	139
84	Lens Shading Correction Configuration 2 Register (LSCCFG2) Field Descriptions .....	140
85	Lens Shading Correction - Center Position (H0) Register (LSCH0) Field Descriptions .....	141
86	Lens Shading Correction - Center Position (V0) Register (LSCV0) Field Descriptions .....	141
87	Lens Shading Correction - Horizontal Coefficients Register (LSCKH) Field Descriptions .....	142
88	Lens Shading Correction - Vertical Coefficients Register (LSCKV) Field Descriptions .....	142
89	Lens Shading Correction - Memory Control Register (LSCMEMCTL) Field Descriptions .....	143
90	Lens Shading Correction - Memory Write Data Register (LSCMEMD) Field Descriptions .....	144
91	Lens Shading Correction - Memory Read Data Register (LSCMEMQ) Field Descriptions .....	144
92	Defect Correction - Control Register (DFCCTL) Field Descriptions.....	145
93	Defect Correction - Vertical Saturation Level Register (DFCVSAT) Field Descriptions .....	146
94	Defect Correction - Memory Control Register (DFCMEMCTL) Field Descriptions.....	147
95	Defect Correction - Set V Position Register (DFCMEM0) Field Descriptions.....	148
96	Defect Correction - Set H Position Register (DFCMEM1) Field Descriptions .....	148
97	Defect Correction - Set SUB1 Register (DFCMEM2) Field Descriptions.....	149
98	Defect Correction - Set SUB2 Register (DFCMEM3) Field Descriptions.....	149
99	Defect Correction - Set SUB3 Register (DFCMEM4) Field Descriptions.....	150
100	Color Space Converter Enable Register (CSCCTL) Field Descriptions .....	150

101	Color Space Converter - Coefficients #0 Register (CSCM0) Field Descriptions .....	151
102	Color Space Converter - Coefficients #1 Register (CSCM1P) Field Descriptions .....	151
103	Color Space Converter - Coefficients #2 Register (CSCM2) Field Descriptions .....	152
104	Color Space Converter - Coefficients #3 Register (CSCM3) Field Descriptions .....	152
105	Color Space Converter - Coefficients #4 Register (CSCM4) Field Descriptions .....	153
106	Color Space Converter - Coefficients #5 Register (CSCM5) Field Descriptions .....	153
107	Color Space Converter - Coefficients #6 Register (CSCM6) Field Descriptions .....	154
108	Color Space Converter - Coefficients #7 Register (CSCM7) Field Descriptions .....	154
109	Data Offset Register (DATAOFST) Field Descriptions .....	155
110	Image Pipe Input Interface Register Map (IPIPEIF).....	156
111	IPIPE I/F Enable Register (ENABLE) Field Descriptions .....	156
112	IPIPE I/F Configuration Register (CFG) Field Descriptions .....	157
113	PIPE I/F Interval of HD / Start pixel in HD Register (PPLN) Field Descriptions .....	159
114	IPIPE I/F Interval of VD / Start line in VD Register (LPFR) Field Descriptions .....	159
115	IPIPE I/F Number of valid pixels per line Register (HNUM) Field Descriptions .....	160
116	IPIPE I/F Number of Valid Lines per Frame Register (VNUM) Field Descriptions .....	160
117	IPIPE I/F Memory Address (Upper) Register (ADDRU) Field Descriptions .....	161
118	IPIPE I/F Memory Address (Lower) Register (ADDRL) Field Descriptions .....	161
119	IPIPE I/F Address Offset of Each Line Register (ADOFS) Field Descriptions.....	162
120	IPIPE I/F Horizontal Resizing Parameter Register (RSZ) Field Descriptions .....	162
121	IPIPE I/F Gain Parameter Register (GAIN) Field Descriptions .....	163
122	Image Pipe Registers (IPIPE) .....	164
123	IPIPE Enable Register (IPIPE_EN) Field Descriptions .....	169
124	One Shot Mode Register (IPIPE_MODE) Field Descriptions .....	169
125	Input/Output Data Paths Register (IPIPE_DPATHS) Field Descriptions .....	170
126	Color Pattern Register (IPIPE_COLPAT) Field Descriptions .....	171
127	Vertical Start Position Register (IPIPE_VST) Field Descriptions .....	172
128	Vertical Processing Size Register (IPIPE_VSZ) Field Descriptions .....	172
129	Horizontal Start Position Register (IPIPE_HST) Field Descriptions.....	173
130	Horizontal Processing Size Register (IPIPE_HSZ) Field Descriptions .....	173
131	ARM Gated Clock Control Register (GCL_ARM) Field Descriptions .....	174
132	CCD Gated Clock Control Register (GCL_CCD) Field Descriptions.....	174
133	SDR Gated Clock Control Register (GCL_SDR) Field Descriptions .....	176
134	Internal Table Selection Register (RAM_MODE) Field Descriptions .....	177
135	Address Register (RAM_ADR) Field Descriptions .....	178
136	Write Data Register (RAM_WDT) Field Descriptions .....	178
137	Read Data Register (RAM_RDT) Field Descriptions.....	178
138	Interrupt Enable Register (IRQ_EN) Field Descriptions .....	179
139	Interval of IRQ-2 Register (IRQ_RZA) Field Descriptions .....	180
140	Interval of IRQ-3 Register (IRQ_RZB) Field Descriptions .....	180
141	Defect Correction Enable Register (DFC_EN) Field Descriptions .....	181
142	Copy Method Selection (from Top or from Bottom) Register (DFC_SEL) Field Descriptions .....	181
143	Start Address in LUT Register (DFC_ADR) Field Descriptions.....	182
144	Number of Available Entries in LUT Register (DFC_SIZ) Field Descriptions .....	182
145	2D Noise Filter Enable Register (D2F_EN) Field Descriptions .....	183
146	Noise Filter Configuration Register (D2F_CFG) Field Descriptions.....	183
147	Noise Filter LUT Values (Threshold) Register (D2F_THR[32]) Field Descriptions.....	184
148	Noise Filter LUT Values (Intensity) Register (D2F_STR[32]) Field Descriptions.....	184
149	PreFilter Enable Register (PRE_EN) Field Descriptions .....	185
150	PreFilter Type Register (PRE_TYP) Field Descriptions .....	185
151	Shift Value of Adaptive Gain Register (PRE_SHF) Field Descriptions .....	186

152	Constant Gain or Adaptive Gain Slope Register (PRE_GAIN) Field Descriptions .....	186
153	Threshold G Register (PRE_THR_G) Field Descriptions .....	187
154	Threshold B Register (PRE_THR_B) Field Descriptions .....	187
155	Threshold 1 Register (PRE_THR_1) Field Descriptions.....	188
156	Digital Gain Register (WB2_DGN) Field Descriptions .....	188
157	White Balance Gain (Red) Register (WB2_WG_R) Field Descriptions.....	189
158	White Balance Gain (Gr) Register (WB2_WG_GR) Field Descriptions .....	189
159	White Balance Gain (Gb) Register (WB2_WG_GB) Field Descriptions .....	190
160	White Balance Gain (Blue) Register (WB2_WG_B) Field Descriptions .....	190
161	Matrix Coefficient RR Register (RGB_MUL_RR) Field Descriptions .....	191
162	Matrix Coefficient GR Register (RGB_MUL_GR) Field Descriptions .....	191
163	Matrix Coefficient BR Register (RGB_MUL_BR) Field Descriptions.....	192
164	Matrix Coefficient RG Register (RGB_MUL_RG) Field Descriptions .....	192
165	Matrix Coefficient GG Register (RGB_MUL_GG) Field Descriptions.....	193
166	Matrix Coefficient BG Register (RGB_MUL_BG) Field Descriptions .....	193
167	Matrix Coefficient RB Register (RGB_MUL_RB) Field Descriptions.....	194
168	Matrix Coefficient GB Register (RGB_MUL_GB) Field Descriptions .....	194
169	Matrix Coefficient BB Register (RGB_MUL_BB) Field Descriptions .....	195
170	R Output Offset Register (RGB_OFT_OR) Field Descriptions .....	195
171	G Output Offset Register (RGB_OFT_OG) Field Descriptions .....	196
172	B Output Offset Register (RGB_OFT_OB) Field Descriptions.....	196
173	Gamma Correction Configuration Register (GMM_CFG) Field Descriptions .....	197
174	Luminance Adjustment (Contrast and Brightness) Register (YCC_ADJ) Field Descriptions .....	198
175	Matrix Coefficient RY Register (YCC_MUL_RY) Field Descriptions .....	198
176	Matrix Coefficient GY Register (YCC_MUL_GY) Field Descriptions.....	199
177	Matrix Coefficient BY Register (YCC_MUL_BY) Field Descriptions .....	199
178	Matrix Coefficient RCb Register (YCC_MUL_RCB) Field Descriptions .....	200
179	Matrix Coefficient GCb Register (YCC_MUL_GCB) Field Descriptions .....	200
180	Matrix Coefficient BCb Register (YCC_MUL_BCB) Field Descriptions.....	201
181	Matrix Coefficient RCr Register (YCC_MUL_RCR) Field Descriptions.....	201
182	Matrix Coefficient GCr Register (YCC_MUL_GCR) Field Descriptions .....	202
183	Matrix Coefficient BCr Register (YCC_MUL_BCR) Field Descriptions .....	202
184	Y Output Offset Register (YCC_OFT_Y) Field Descriptions .....	203
185	Cb Output Offset Register (YCC_OFT_CB) Field Descriptions .....	203
186	Cr Output Offset Register (YCC_OFT_CR) Field Descriptions.....	204
187	Saturation (Luminance Minimum) Register (YCC_Y_MIN) Field Descriptions .....	204
188	Saturation (Luminance Maximum) Register (YCC_Y_MAX) Field Descriptions.....	205
189	Saturation (Chrominance Minimum) Register (YCC_C_MIN) Field Descriptions .....	205
190	Saturation (Chrominance Maximum) Register (YCC_C_MAX) Field Descriptions.....	206
191	Chrominance Position (for 422 down sampler) Register (YCC_PHS) Field Descriptions.....	206
192	Edge Enhancer Enable Register (YEE_EN) Field Descriptions .....	207
193	MedianNR Enable Register (YEE_EMF) Field Descriptions .....	207
194	HPF Shift Length Register (YEE_SHF) Field Descriptions.....	208
195	HPF Coefficient 00 Register (YEE_MUL_00) Field Descriptions.....	208
196	HPF Coefficient 01 Register (YEE_MUL_01) Field Descriptions.....	209
197	HPF Coefficient 02 Register (YEE_MUL_02) Field Descriptions.....	209
198	HPF Coefficient 10 Register (YEE_MUL_10) Field Descriptions.....	210
199	HPF Coefficient 11 Register (YEE_MUL_11) Field Descriptions.....	210
200	HPF Coefficient 12 Register (YEE_MUL_12) Field Descriptions.....	211
201	HPF Coefficient 20 Register (YEE_MUL_20) Field Descriptions.....	211
202	HPF Coefficient 21 Register (YEE_MUL_21) Field Descriptions.....	212

203	HPF Coefficient 22 Register (YEE_MUL_22) Field Descriptions.....	212
204	Fault Color Suppression Enable Register (FCS_EN) Field Descriptions.....	213
205	Type selection of HPF Register (FCS_TYP) Field Descriptions.....	213
206	Down Shift Size (HPF) Register (FCS_SHF_Y) Field Descriptions.....	214
207	Down Shift Size (GAIN) Register (FCS_SHF_C) Field Descriptions.....	214
208	Threshold Register (FCS_THR) Field Descriptions.....	215
209	Intensity Register (FCS_SGN) Field Descriptions.....	215
210	Lower Limit of Chroma Gain Register (FCS_LTH) Field Descriptions.....	215
211	Processing Mode Register (RSZ_SEQ) Field Descriptions.....	216
212	Vertical Anti aliasing Filter Register (RSZ_AAL) Field Descriptions.....	217
213	Resizer Enable Register (RSZ_EN) Field Descriptions.....	217
214	One Shot Mode Register (RSZ_MODE) Field Descriptions.....	218
215	Vertical Start Position of the Input Register (RSZ_I_VST) Field Descriptions.....	218
216	Vertical Size of the Input Register (RSZ_I_VSZ) Field Descriptions.....	219
217	Horizontal Start Position of the Input Register (RSZ_I_HST) Field Descriptions.....	219
218	Vertical Size of the Output Register (RSZ_O_VSZ) Field Descriptions.....	220
219	Horizontal Start Position of the Output Register (RSZ_O_HST) Field Descriptions.....	220
220	Horizontal Size of the Output Register (RSZ_O_HSZ) Field Descriptions.....	221
221	Initial Phase of Vertical Resizing Process Register (RSZ_V_PHS) Field Descriptions.....	221
222	Phase of Last Value in Previous Resize Process Register (RSZ_V_PHS_O) Field Descriptions.....	222
223	Vertical Resize Parameter Register (RSZ_V_DIF) Field Descriptions.....	222
224	Actual Number of Output Lines Register (RSZ_V_SIZ_O) Field Descriptions.....	223
225	Initial Phase of Horizontal Resizing Process Register (RSZ_H_PHS) Field Descriptions.....	223
226	Horizontal Resize Parameter Register (RSZ_H_DIF) Field Descriptions.....	224
227	Interpolation Method for Horizontal Rescaling Register (RSZ_H_TYP) Field Descriptions.....	224
228	Selection of Horizontal LPF Intensity Register (RSZ_H_LSE) Field Descriptions.....	225
229	Horizontal LPF Intensity Register (RSZ_H_LPF) Field Descriptions.....	225
230	RGB Output Enable Register (RSZ_RGB_EN) Field Descriptions.....	226
231	RGB Output Bit Mode (32 or 16 bit) Register (RSZ_RGB_TYP) Field Descriptions.....	226
232	YC422 to YC444 Conversion Method Register (RSZ_RGB_BLD) Field Descriptions.....	227
233	SDRAM Base Address MSB Register (RSZ_SDR_BAD_H) Field Descriptions.....	227
234	SDRAM Base Address LSB Register (RSZ_SDR_BAD_L) Field Descriptions.....	228
235	SDRAM Start Address MSB Register (RSZ_SDR_SAD_H) Field Descriptions.....	228
236	SDRAM Start Address LSB Register (RSZ_SDR_SAD_L) Field Descriptions.....	229
237	SDRAM Line Offset Register (RSZ_SDR_OFT) Field Descriptions.....	229
238	Start Line of SDRAM Pointer Register (RSZ_SDR_PTR_S) Field Descriptions.....	230
239	End Line of SDRAM Pointer Register (RSZ_SDR_PTR_E) Field Descriptions.....	231
240	Output of Current Pointer Value (Read Only) Register (RSZ_SDR_PTR_O) Field Descriptions.....	232
241	Boxcar Enable Register (BOX_EN) Field Descriptions.....	232
242	One Shot Mode Register (BOX_MODE) Field Descriptions.....	233
243	Block Size (16x16 or 8x8) Register (BOX_TYP) Field Descriptions.....	233
244	Down Shift Value of Input Register (BOX_SHF) Field Descriptions.....	234
245	Histogram Enable Register (HST_EN) Field Descriptions.....	234
246	One Shot Mode Register (HST_MODE) Field Descriptions.....	235
247	Histogram Source Select Register (HST_SEL) Field Descriptions.....	235
248	Histogram Parameters Select Register (HST_PARA) Field Descriptions.....	236
249	Vertical Start Position Register (HST_VST) Field Descriptions.....	237
250	Vertical Size Register (HST_VSZ) Field Descriptions.....	237
251	Horizontal Start Position Register (HST_HST) Field Descriptions.....	237
252	Horizontal Size Register (HST_HSZ) Field Descriptions.....	238
253	Hardware 3A Register Map (H3A).....	239

254	Peripheral ID Register (PID) Field Description.....	240
255	Peripheral Control Register (PCR) Field Descriptions .....	241
256	Setup for the AF Engine Poxel Configuration Register (AFPAX1) Field Descriptions.....	243
257	Setup for the AF Engine Poxel Configuration Register (AFPAX2) Field Descriptions.....	244
258	Start Position for AF Engine Poxels Register (AFPAXSTART) Field Descriptions .....	245
259	Start Position for IIRSH Register (AFIIRSH) Field Descriptions.....	246
260	SDRAM/DDRAM Start Address for AF Engine Register (AFBUFST) Field Descriptions .....	246
261	IIR Filter Coefficient Data for SET 0 Register (AFCOEF010) Field Descriptions .....	247
262	IR Filter Coefficient Data for Set 0 Register (AFCOEF032) Field Descriptions .....	247
263	IIR Filter Coefficient Data for SET 0 Register (AFCOEFF054) Field Descriptions.....	248
264	IIR Filter Coefficient Data for SET 0 Register (AFCOEFF076) Field Descriptions.....	249
265	Lens Center (LD) Register (CENTER) Field Descriptions.....	249
266	IIR Filter Coefficient Data for SET 0 Register (AFCOEFF0010) Field Descriptions .....	250
267	IIR Filter Coefficient Data for SET 1 Register (AFCOEF110) Field Descriptions .....	251
268	IIR Filter Coefficient Data for SET 1 Register (AFCOEF132) Field Descriptions .....	251
269	IIR Filter Coefficient Data for SET 1 Register (AFCOEFF154) Field Descriptions.....	252
270	IIR Filter Coefficient Data for SET 1 Register (AFCOEFF176) Field Descriptions.....	252
271	IIR Filter Coefficient Data for SET 1 Register (AFCOEFF198) Field Descriptions.....	253
272	IIR Filter Coefficient Data for SET 1 Register (AFCOEFF1010) Field Descriptions .....	254
273	Configuration for AE/AWB Windows Register (AEWIN1) Field Descriptions.....	255
274	Start Position for AE/AWB Windows Register (AEWINSTART) Field Descriptions.....	256
275	Start Position and Height for Black Line of AE/AWB Windows Register (AEWINBLK) Field Descriptions ...	257
276	Configuration for Subsample Data in AE/AWB Window Register (AEWSUBWIN) Field Descriptions .....	258
277	SDRAM/DDRAM Start Address for AE/AWB Engine Output Data Register (AEWBUFST) Field Descriptions .....	259
278	SDRAM/DDRAM Read Address for AE/AWB Engine Register (RSDR_ADDR) Field Descriptions .....	259
279	Line Offset for the Read Data Register (RADR_OFFSET) Field Descriptions .....	260
280	Frame Size for SDRAM Read Data Register (SDR_FRSIZE) Field Descriptions.....	261
281	VPSS Buffer Logic Register Map (VPSSBL) .....	262
282	Peripheral ID Register (PID) Field Description.....	262
283	Peripheral Control Register (PCR) Field Descriptions .....	263
284	Interrupt Status Register (INTSTAT) Field Descriptions.....	264
285	Interrupt Selection Register (INTSEL) Field Descriptions .....	266
286	Event Selection Register (EVTSEL) Field Descriptions .....	267
287	Shared Memory Master Select Register (MEMCTRL) Field Descriptions.....	268
288	VPSS Clock Control Register Map (VPSSCLK) .....	269
289	Peripheral ID Register (PID) Field Description.....	269
290	VPSS Clock Control Register (CLKCTRL) Field Descriptions .....	270
A-1	Changes Made in This Revision .....	271



## Read This First

---

---

---

### About This Manual

This document describes the operation of the Video Processing Front End in the TMS320DM35x Digital Media System-on-Chip (DMSoC).

### Notational Conventions

This document uses the following conventions.

- Hexadecimal numbers are shown with the suffix h. For example, the following number is 40 hexadecimal (decimal 64): 40h.
- Registers in this document are shown in figures and described in tables.
  - Each register figure shows a rectangle divided into fields that represent the fields of the register. Each field is labeled with its bit name, its beginning and ending bit numbers above, and its read/write properties below. A legend explains the notation used for the properties.
  - Reserved bits in a register figure designate a bit that is used for future device expansion.

### Related Documentation From Texas Instruments

The following documents describe the TMS320DM35x Digital Media System-on-Chip (DMSoC). Copies of these documents are available on the internet at [www.ti.com](http://www.ti.com).

**[SPRS463](#)** — ***TMS320DM355 Digital Media System-on-Chip (DMSoC) Data Manual*** This document describes the overall TMS320DM355 system, including device architecture and features, memory map, pin descriptions, timing characteristics and requirements, device mechanicals, etc.

**[SPRZ264](#)** — ***TMS320DM355 DMSoC Silicon Errata*** Describes the known exceptions to the functional specifications for the TMS320DM355 DMSoC.

**[SPRUFB3](#)** — ***TMS320DM35x Digital Media System-on-Chip (DMSoC) ARM Subsystem Reference Guide*** This document describes the ARM Subsystem in the TMS320DM35x Digital Media System-on-Chip (DMSoC). The ARM subsystem is designed to give the ARM926EJ-S (ARM9) master control of the device. In general, the ARM is responsible for configuration and control of the device; including the components of the ARM Subsystem, the peripherals, and the external memories.

**[SPRUED1](#)** — ***TMS320DM35x Digital Media System-on-Chip (DMSoC) Asynchronous External Memory Interface (EMIF) Reference Guide*** This document describes the asynchronous external memory interface (EMIF) in the TMS320DM35x Digital Media System-on-Chip (DMSoC). The EMIF supports a glueless interface to a variety of external devices.

**[SPRUED2](#)** — ***TMS320DM35x Digital Media System-on-Chip (DMSoC) Universal Serial Bus (USB) Controller Reference Guide*** This document describes the universal serial bus (USB) controller in the TMS320DM35x Digital Media System-on-Chip (DMSoC). The USB controller supports data throughput rates up to 480 Mbps. It provides a mechanism for data transfer between USB devices and also supports host negotiation.

**[SPRUED3](#)** — ***TMS320DM35x Digital Media System-on-Chip (DMSoC) Audio Serial Port (ASP) Reference Guide*** This document describes the operation of the audio serial port (ASP) audio interface in the TMS320DM35x Digital Media System-on-Chip (DMSoC). The primary audio modes that are supported by the ASP are the AC97 and IIS modes. In addition to the primary audio modes, the ASP supports general serial port receive and transmit operation, but is not intended to be used as a high-speed interface.

**SPRUED4 — TMS320DM35x Digital Media System-on-Chip (DMSoC) Serial Peripheral Interface (SPI)**

**Reference Guide** This document describes the serial peripheral interface (SPI) in the TMS320DM35x Digital Media System-on-Chip (DMSoC). The SPI is a high-speed synchronous serial input/output port that allows a serial bit stream of programmed length (1 to 16 bits) to be shifted into and out of the device at a programmed bit-transfer rate. The SPI is normally used for communication between the DMSoC and external peripherals. Typical applications include an interface to external I/O or peripheral expansion via devices such as shift registers, display drivers, SPI EPROMs and analog-to-digital converters.

**SPRUED9 — TMS320DM35x Digital Media System-on-Chip (DMSoC) Universal Asynchronous**

**Receiver/Transmitter (UART) Reference Guide** This document describes the universal asynchronous receiver/transmitter (UART) peripheral in the TMS320DM35x Digital Media System-on-Chip (DMSoC). The UART peripheral performs serial-to-parallel conversion on data received from a peripheral device, and parallel-to-serial conversion on data received from the CPU.

**SPRUJEE0 — TMS320DM35x Digital Media System-on-Chip (DMSoC) Inter-Integrated Circuit (I2C)**

**Peripheral Reference Guide** This document describes the inter-integrated circuit (I2C) peripheral in the TMS320DM35x Digital Media System-on-Chip (DMSoC). The I2C peripheral provides an interface between the DMSoC and other devices compliant with the I2C-bus specification and connected by way of an I2C-bus. External components attached to this 2-wire serial bus can transmit and receive up to 8-bit wide data to and from the DMSoC through the I2C peripheral. This document assumes the reader is familiar with the I2C-bus specification.

**SPRUJEE2 — TMS320DM35x Digital Media System-on-Chip (DMSoC) Multimedia Card (MMC)/Secure**

**Digital (SD) Card Controller Reference Guide** This document describes the multimedia card (MMC)/secure digital (SD) card controller in the TMS320DM35x Digital Media System-on-Chip (DMSoC). The MMC/SD card is used in a number of applications to provide removable data storage. The MMC/SD controller provides an interface to external MMC and SD cards. The communication between the MMC/SD controller and MMC/SD card(s) is performed by the MMC/SD protocol.

**SPRUJEE4 — TMS320DM35x Digital Media System-on-Chip (DMSoC) Enhanced Direct Memory**

**Access (EDMA) Controller Reference Guide** This document describes the operation of the enhanced direct memory access (EDMA3) controller in the TMS320DM35x Digital Media System-on-Chip (DMSoC). The EDMA controller's primary purpose is to service user-programmed data transfers between two memory-mapped slave endpoints on the DMSoC.

**SPRUJEE5 — TMS320DM35x Digital Media System-on-Chip (DMSoC) 64-bit Timer Reference Guide**

This document describes the operation of the software-programmable 64-bit timers in the TMS320DM35x Digital Media System-on-Chip (DMSoC). Timer 0, Timer 1, and Timer 3 are used as general-purpose (GP) timers and can be programmed in 64-bit mode, dual 32-bit unchained mode, or dual 32-bit chained mode; Timer 2 is used only as a watchdog timer. The GP timer modes can be used to generate periodic interrupts or enhanced direct memory access (EDMA) synchronization events and Real Time Output (RTO) events (Timer 3 only). The watchdog timer mode is used to provide a recovery mechanism for the device in the event of a fault condition, such as a non-exiting code loop.

**SPRUJEE6 — TMS320DM35x Digital Media System-on-Chip (DMSoC) General-Purpose Input/Output**

**(GPIO) Reference Guide** This document describes the general-purpose input/output (GPIO) peripheral in the TMS320DM35x Digital Media System-on-Chip (DMSoC). The GPIO peripheral provides dedicated general-purpose pins that can be configured as either inputs or outputs. When configured as an input, you can detect the state of the input by reading the state of an internal register. When configured as an output, you can write to an internal register to control the state driven on the output pin.

**SPRUJEE7 — TMS320DM35x Digital Media System-on-Chip (DMSoC) Pulse-Width Modulator (PWM)**

**Reference Guide** This document describes the pulse-width modulator (PWM) peripheral in the TMS320DM35x Digital Media System-on-Chip (DMSoC).

- [SPRUEH7](#)** — ***TMS320DM35x Digital Media System-on-Chip (DMSoC) DDR2/Mobile DDR (DDR2/mDDR) Memory Controller Reference Guide*** This document describes the DDR2/mDDR memory controller in the TMS320DM35x Digital Media System-on-Chip (DMSoC). The DDR2/mDDR memory controller is used to interface with JESD79D-2A standard compliant DDR2 SDRAM and mobile DDR devices.
- [SPRUF71](#)** — ***TMS320DM35x Digital Media System-on-Chip (DMSoC) Video Processing Front End (VPFE) Reference Guide*** This document describes the Video Processing Front End (VPFE) in the TMS320DM35x Digital Media System-on-Chip (DMSoC).
- [SPRUF72](#)** — ***TMS320DM35x Digital Media System-on-Chip (DMSoC) Video Processing Back End (VPBE) Reference Guide*** This document describes the Video Processing Back End (VPBE) in the TMS320DM35x Digital Media System-on-Chip (DMSoC).
- [SPRUF74](#)** — ***TMS320DM35x Digital Media System-on-Chip (DMSoC) Real-Time Out (RTO) Controller Reference Guide*** This document describes the Real Time Out (RTO) controller in the TMS320DM35x Digital Media System-on-Chip (DMSoC).
- [SPRUF78](#)** — ***TMS320DM35x Digital Media System-on-Chip (DMSoC) Peripherals Overview Reference Guide*** This document provides an overview of the peripherals in the TMS320DM35x Digital Media System-on-Chip (DMSoC).
- [SPRAAR3](#)** — ***Implementing DDR2/mDDR PCB Layout on the TMS320DM35x DMSoC*** This provides board design recommendations and guidelines for DDR2 and mobile DDR.

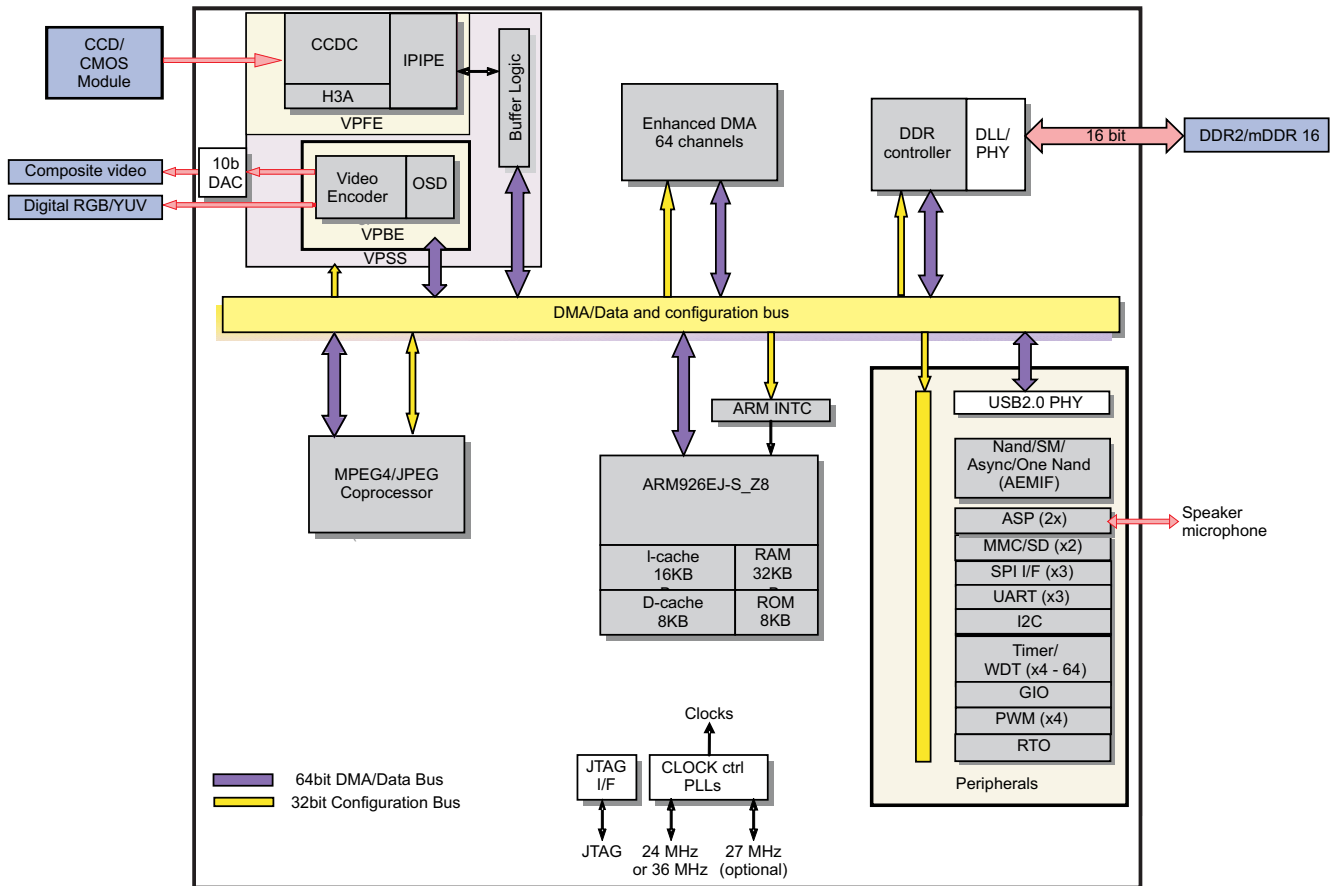
## Trademarks

## Video Processing Front End (VPFE)

### 1 Video Processing Front End Overview

The Digital Media System-on-Chip (DMSoC), [Figure 1](#), is a highly integrated, programmable platform for digital still/video cameras and other mobile imaging devices. Designed to offer camera manufacturers the ability to produce affordable DSC products with high picture quality, this device combines programmable image processing capability with a highly integrated imaging peripheral set. The device also enables seamless interface to most additional external devices required for a complete digital camera digital implementation via the Video Processing Front End Subsystem (VPFE). The interface is flexible enough to support various types of CCD and CMOS sensors, signal conditioning circuits, power management, SDRAM, SRAM, shutter, Iris and auto-focus motor controls.

**Figure 1. Functional Block Diagram**

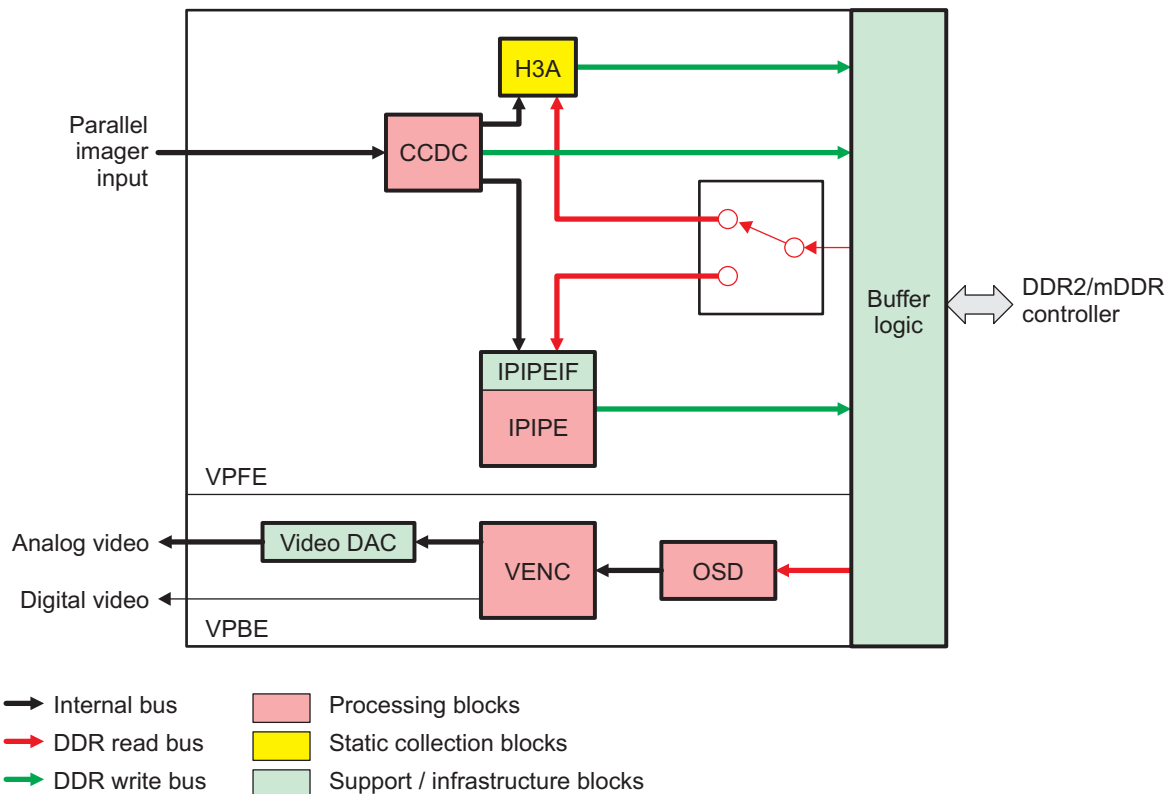


### 1.1 Purpose of the Video Processing Front End

The device contains a Video Processing Subsystem (VPSS), [Figure 2](#), that provides an input interface (Video Processing Front End or VPFE) for external imaging peripherals such as image sensors, video decoders, etc.; and an output interface (Video Processing Back End or VPBE) for display devices, such as analog SDTV displays, digital LCD panels, HDTV video encoders, etc.

In addition to these peripherals, there is a set of common buffer memory and DMA control to ensure efficient use of the DDR2/mDDR controller burst bandwidth. The buffer logic/memory is a unique block that is tailored for seamlessly integrating the VPSS into an image/video processing system. It acts as the primary source or sink to all the VPFE and VPBE modules that are either requesting or transferring data from/to DDR2/mDDR controller. In order to efficiently utilize the external DDR2/mDDR controller bandwidth, the buffer logic/memory interfaces with the DMA system via a high bandwidth bus (64-bit wide). The buffer logic/memory (divided into the read and write buffers and arbitration logic) is capable of performing the following functions. It is imperative that the VPSS utilize DDR2/mDDR controller bandwidth efficiently due to both its large bandwidth requirements and the real-time requirements of the VPSS modules.

**Figure 2. Video Processing Subsystem (VPSS) Block Diagram**



## 1.2 Features

The VPFE block is comprised of the CCD Controller (CCDC), Image Pipe (IPIPE), Image Pipe Interface (IPIPEIF), and Hardware 3A Statistic Generator (H3A) blocks. Together, these modules provide the device with a powerful and flexible front-end interface. These modules can be broken down into two distinct types. The first type consists of major processing modules that are in the direct data flow path and affect the input image data stream. These are described below:

- The CCD Controller (CCDC) provides an interface to image sensors and digital video sources.
- The image pipe (IPIPE) is a parameterized hardwired image processing block whose image processing functions can be customized for each sensor type to realize good still image quality as well supporting video frame rates for digital still camera preview displays and video recording modes. An image resizer is also fully integrated within this module. Additionally, the IPIPE contains the following statistic collection function: histogram and the boundary signal calculator (for motion vector compensation).

In addition to the modules that directly affect that input image data, there is one independent module that provides statistics on the incoming images to aid designers of camera systems.

- The hardware 3A (H3A) module is designed to support the control loops for auto focus (AF), auto white balance (AWB) and auto exposure (AE) by collecting metrics on the RAW image data from the CCD controller.

### 1.2.1 CCD Controller (CCDC)

The CCDC is responsible for accepting RAW (unprocessed) image/video data from a sensor (CMOS or CCD). In addition, the CCDC can accept YCbCr video data in numerous formats, typically from so-called video decoder devices. In the case of RAW inputs, the CCDC output requires additional image processing to transform the RAW input image to the final processed image. This processing can be done in the Image Pipe. The CCDC is programmed via control and parameter registers. The following features are supported by the CCDC module.

- Support for conventional Bayer pattern sensor format.
- Support for complimentary color pattern input via a color space converter.
- Generates HD/VD timing signals to an external timing generator or can synchronize to the external timing generator.
- Support for progressive and interlaced sensors (hardware support for up to 2 fields and firmware support for higher number of fields, typically 3-, 4-, and 5-field sensors).
- Support for up to 75-MHZ sensor pixel clock, if H3A is not used; otherwise, the pixel clock must be less than 67.5 MHZ.
- Support for ITU-R BT.656 standard format, either 8-bit or 10-bit.
- Support for YCbCr422 format, either 8-bit or 16-bit with discrete H and VSYNC signals.
- Support for up to 14-bit raw data from a CCD/CMOS sensor.
- Generates optical black clamping signals.
- Support for shutter signal control.
- Support for digital clamping and black level compensation.
- Defect correction based on a lookup table that contains row and column position of the pixel to be corrected.
- Programmable Lens Shading Correction.
- Support for 10-bit to 8-bit A-law compression.
- Support for a low-pass filter prior to writing to SDRAM. If this filter is enabled, 2 pixels each in the left and right edges of each line are cropped from the output.
- Support for generating output to range from 14-bits to 8-bits wide (8-bits wide allows for 50% saving in storage area).
- Support for downsampling via programmable culling patterns.
- Ability to control output to the DDR2/mDDR controller via an external write enable signal.
- Supported maximum CCD imager size is 32,768 × 32,768.

### 1.2.2 Image Pipe – Hardware Image Signal Processor (IPIPE)

The Image Pipe (IPIPE) is a programmable hardware image processing module that generates image data in YCbCr-4:2:2 format from raw CCD/CMOS data. The IPIPE can also be configured to operate in a resize only mode, which allows YCbCr-4:2:2 to be resized without applying the processing of every module in the IPIPE. The following features are supported by the IPIPE.

- Support for 14 bit RAW data image processing or 16 bit YCbCr resizing
- Support RGB Bayer pattern for input color filter array. (Support for complementary CMYG pattern is also provided via the Color Space Converter.)
- Require at least 8 pixels for horizontal blanking and 4 lines for vertical blanking. In one shot mode, 10 blanking lines after processing area are required.
- Maximum horizontal and vertical offset of IPIPE processing area from synchronous signal is 8191.
- Support for a maximum input and output widths up to 1344 pixels wide (640 for RSZ[1]).
- Support dark frame subtract in IPIPEIF by providing a raw pass-through mode supporting images wider than 1344 pixels.
- Support for automatic mirroring of pixels/lines when edge processing is performed so that the width and height is consistent throughout.
- Defect correction based on a lookup table that contains row and column position of the pixel to be corrected.
- Horizontal /Vertical noise reduction filter
- Gain control for white balancing at each component
- CFA interpolation for good quality CFA interpolation with reduced false color artifacts
- Programmable RGB-to-RGB blending matrix (9 coefficients for the 3 × 3 matrix).
- Programmable coefficients for RGB to YCbCr conversion
- Programmable lookup table for Luminance edge enhance
- Faulty-color suppression filter
- Programmable down or up-sampling filter for both horizontal and vertical directions with range from 1/16x to 8x, in which the filter outputs two images with different magnification simultaneously.
- Flipping image vertically and/or horizontally
- RGB (32bit/16bit) output to SDRAM
- Programmable Histogram engine (4 windows, 256 bins)
- Boxcar calculation

### 1.2.3 Hardware 3A (H3A)

The H3A module is designed to support the control loops for auto focus, auto white balance and auto exposure by collecting metrics about the imaging/video data. The metrics are to adjust the various parameters for processing the imaging/video data. There are two main blocks in the H3A module:

- Auto focus engine
- Auto exposure and auto white balance engine

The AF engine extracts and filters the red, green, and blue data from the input image/video data and provides either the accumulation or peaks of the data in a specified region. The specified region is a two-dimensional block of data and is referred to as a *paxel* for the case of AF.

The AE/AWB engine accumulates the values and checks for saturated values in a sub sampling of the video data. In the case of the AE/AWB, the two-dimensional block of data is referred to as a “window”. Thus, other than referring them by different names, a paxel and a window are essentially the same thing. However, the number, dimensions, and starting position of the AF paxels and the AE/AWB windows are separately programmable.

### 1.2.3.1 Auto Focus Engine Features

The following features are supported by the AF engine.

- Support for a peak mode in a paxel (a paxel is defined as a two dimensional block of pixels).
  - Accumulate the maximum focus value of each line in a paxel
- Support for an accumulation/sum mode (instead of peak mode).
- Support for an accumulation/sum mode (instead of peak mode).
- Support for up to 36 paxels in the horizontal direction and up to 128 paxels in the vertical direction.
- Programmable width and height for the paxel. All paxels in the frame will be the same size.
- Programmable red, green, and blue position within a  $2 \times 2$  matrix.
- Separate horizontal start for paxel and filtering.
- Programmable horizontal and vertical line increments within a paxel.
- Parallel IIR filters configured in a dual-biquad configuration with individual coefficients (two filters with 11 coefficients each). The filters are intended to compute the sharpness/peaks in the frame to focus on.

### 1.2.3.2 Auto Exposure and Auto White Balance Features

The following features are supported by the AE/AWB engine.

- Accumulate clipped pixels along with all non-saturated pixels.
- Support for up to 36 horizontal windows and up to 128 vertical windows..
- Programmable width and height for the windows. All windows in the frame will be the same size.
- Separate vertical start coordinate and height for a black row of paxels that is different than the remaining color paxels.
- Programmable horizontal sampling points in a window
- Programmable vertical sampling points in a window

### 1.2.4 Image Pipe Interface (IPIPEIF)

The image pipe input interface module is an input extension to the image pipe. It can receive data from the CCDC, SDRAM, or both (darkframe subtract) and pass the data to the IPIPE. Depending on the functions performed, it may also readjust the HD, VD, and PCLK timing to the IPIPE input.

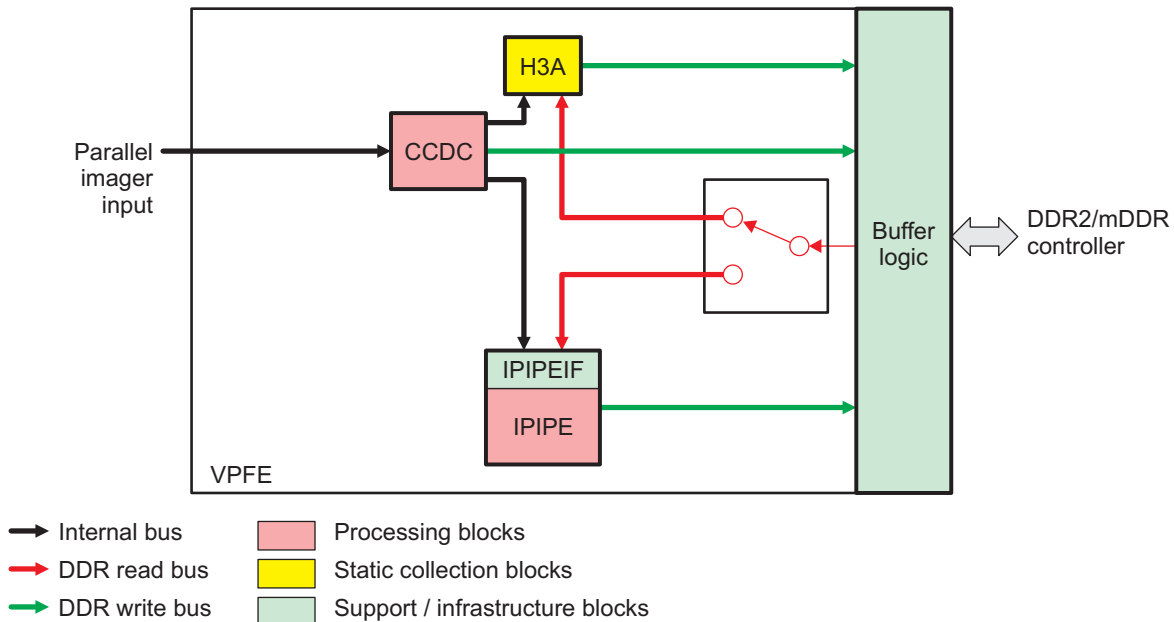
- Supports dark-frame subtract of raw image stored in DDRAM from image from CCDC
- Supports inverse ALAW decompression of RAW data from DDRAM.
- Supports (1,2,1) average filtering before horizontal decimation
- Supports horizontal decimation (downsizing) of input lines to  $\leq 1344$  maximum required by the image pipe
- Supports gain multiply for raw data



### 1.3 Functional Block Diagram

Figure 3 shows a high-level functional block diagram of the VPFE functional blocks, along with the different data flow paths. These data flow paths show how the various modules of the VPFE interact. The parallel input to the CCDC is either 14-bit RAW digital sensor image data from an AFE or 8- to-16 bit YCbCr video data. The input to the H3A is only RAW sensor image data. The input to the IPIPE can be RAW or YCbCr video data (for resizing). Since the DDR2/mDDR controller read buffer is shared by the H3A and IPIPE, these modules can not concurrently read from the DDR2/mDDR controller.

Figure 3. Video Processing Front End (VPFE) Block Diagram and Data Flows



### 1.4 Supported Use Case Statement

The VPFE supports image data acquisition from sensor and digital video sources in various modes/formats. YCbCr sources have minimal image processing applied and can either be passed directly to the DDR2/mDDR controller or passed through the IPIPE's Resizer for scaling prior to writing to the DDR2/mDDR controller. RAW imager data modes (non-YCbCr sources) are supported by the statistics collection modules (H3A and IPIPE's histogram) as well as full image pipe processing functions, including resize.

The same processing options are supported when processing data sourced from the DDR2/mDDR controller. The only exception is that the IPIPEIF module cannot perform dark frame subtract on data from the DDR2/mDDR controller.

Zooming at ratios greater than the 8x ratio in a single pass are not supported by the IPIPE's resizer. However, this can be done by passing the resized data from the DDR2/mDDR controller through the resizer again as long as the real-time deadlines can be met.

## 1.5 Industry Standard(s) Compliance Statement

ITU-R BT.656, REC601

## 2 VPFE/ISP I/O Interfacing

This section addresses the configuration of any external connections that the VPFE/ISP may have at the interface of the device, including I/O signals lists, I/O pin multiplexing, and protocol/data formats for typical application(s).

The VPFE signals are shown in [Table 1](#). Note that these signals can take on different meanings depending on the specific interface chosen. All of the digital input signals below are multiplexed as GIO signals at reset (not shown in [Table 1](#)), and some are also multiplexed as SPI2 signals. Pin multiplexing is controlled from the System Module. The following sections describe each of the input interface scenarios supported.

**Table 1. Interface Signals for Video Processing Front End**

Pin Name	I/O	Description
PCLK	Bidi	Pixel Clock
CAM_VD	Bidi	V sync
CAM_HD	Bidi	H sync
CIN7/SPI2_SCLK	Bidi	C IN signal
CIN6/SPI2_SDO	Bidi	C IN signal
CIN5/CCD13/SPI2_SDENA	Bidi	C IN signal/CCD in signal
CIN4/CCD12/SPI2_SDENB/SPI2_SDI3	Bidi	C IN signal/CCD in signal
CIN3/CCD11	Bidi	C IN signal/CCD in signal
CIN2/CCD10	Bidi	C IN signal/CCD in signal
CIN1/CCD9	Bidi	C IN signal/CCD in signal
CIN0/CCD8	Bidi	C IN signal/CCD in signal
YIN7/CCD7	Bidi	C IN signal/CCD in signal
YIN6/CCD6	Bidi	C IN signal/CCD in signal
YIN5/CCD5	Bidi	C IN signal/CCD in signal
YIN4/CCD4	Bidi	C IN signal/CCD in signal
YIN3/CCD3	Bidi	C IN signal/CCD in signal
YIN2/CCD2	Bidi	C IN signal/CCD in signal
YIN1/CCD1	Bidi	C IN signal/CCD in signal
YIN0/CCD0	Bidi	C IN signal/CCD in signal
CAM_WEN_FIELD	Bidi	CCD Write Enable/Field ID signal

## 2.1 Parallel Generic Interface Configuration (RAW)

The generic RAW interface configuration is typically used for interfacing to image sensors. The device can support up to 14 bits of resolution for each sample.

### 2.1.1 Parallel Generic Configuration (RAW) Signal Interface

Table 2 shows the interface connections for the RAW Mode interface.

**Table 2. Interface Signals for Parallel Raw Mode**

Pin Name	I/O	Description
PCLK	Bidi	Pixel Clock
CAM_VD	Bidi	V sync
CAM_HD	Bidi	H sync
SPI2_SCLK/GIO101	Bidi	Optional SPI signal or GIO
SPI2_SDO/GIO100	Bidi	Optional SPI signal or GIO
CCD13/SPI2_SDENA/GIO099	Bidi	CCD in signal/Optional SPI signal or GIO
CCD12/SPI2_SDENB/SPI2_SDI3/GIO098	Bidi	CCD in signal/Optional SPI signal or GIO
CCD11	Bidi	CCD in signal
CCD10	Bidi	CCD in signal
CCD9	Bidi	CCD in signal
CCD8	Bidi	CCD in signal
CCD7	Bidi	CCD in signal
CCD6	Bidi	CCD in signal
CCD5	Bidi	CCD in signal
CCD4	Bidi	CCD in signal
CCD3	Bidi	CCD in signal
CCD2	Bidi	CCD in signal
CCD1	Bidi	CCD in signal
CCD0	Bidi	CCD in signal
CAM_WEN_FIELD/GIO083	Bidi	CCD Write Enable/Field ID signal

The device can support up to 14 bits of resolution for each sample but sensors typically only output 8, 10, 12, or 14 bits of useful resolution depending on the imager and associated AFE. When the number of data lines is less than 14, it is recommended to connect RAW data to the upper data lines of CCD[13:0]. The exception to this rule is as follows:

- If there are less than 14 data lines, and
- The application requires the use of the SPI2 peripheral OR extra GPIOs.

If the above conditions above are met, then it is required to connect RAW data to the upper data lines of CCD[12:0] (for RAW13) or CCD[11:0] (for less than 13 data lines) instead of CCD[13:0] to make the SPI2 peripheral pins or GPIOs available. Table 3 outlines examples of CCD RAW data connection options based on the number of data lines available. Lines not connected (indicated by '-' in the table) should be floating (since there are internal pull-downs) or tied low.

**Table 3. Imager Data Connection Examples**

Data Pin	Imager Data Line Numbers				
	RAW14	RAW13 + SPI2	RAW12 + SPI2	RAW11 + SPI2	RAW10 + SPI2
CCD13	13	SPI2	SPI2	SPI2	SPI2
CCD12	12	12	SPI2	SPI2	SPI2
CCD11	11	11	11	10	9
CCD10	10	10	10	9	8
CCD9	9	9	9	8	7
CCD8	8	8	8	7	6
CCD7	7	7	7	6	5
CCD6	6	6	6	5	4
CCD5	5	5	5	4	3
CCD4	4	4	4	3	2
CCD3	3	3	3	2	1
CCD2	2	2	2	1	0
CCD1	1	1	1	0	
CCD0	0	0	0		

If the input interface is configured on the upper lines of CCD[12:0] or CCD[11:0], then the CCDC, IPIPEIF, or IPIPE gain functions will need to be used to increase multiply the data by 2× or 4×, respectively to effectively shift the data up. [Table 4](#) indicates the available gain function options where this multiply can be applied.

**Table 4. Available Gain Functions for Bit Shifting the Data**

Name	Block	Module	Max Gain	Comments
Color Space conversion	CSC	CCDC	3.969	
Lens Shading	LCS	CCDC	1.9	
IPIPEIF Gain	GAIN	IPIPEIF	1.998	After subtraction of dark frame
White Balance Total gain	WB2_DGN	IPIPE	3.969	Affects all colors
White Balance For Each color	WB2_WG_x	IPIPE	7.992	Separate gain for each color
RGB2RGB	RGB_MUL_xx	IPIPE	7.996	

### 2.1.2 Parallel Generic Configuration (RAW) Signal Interface Description

The signal interface is described in [Table 5](#).

**Table 5. CCD/CMOS Interface Signals**

Name	I/O	Description
CCD[13:0]	I	Image data. Mode set by INPMOD (not R656ON). <ul style="list-style-type: none"> <li>• Bit width can be configured between 8 and 16 bits (DATSIZ)</li> <li>• The polarity of the input image data can be reversed (DATAPOL)</li> </ul>
CAM_VD	I/O	VSYNC. This vertical sync signal can be configured as an input or an output (VDHDOUT). <ul style="list-style-type: none"> <li>• When configured as an input, the CCD or CMOS sensor must supply the VD signal</li> <li>• When configured as an output, supplies the VD signal and the Vd width and lines per frame must be configured (VDW, HLPFR)</li> <li>• The polarity of VD can be reversed. (VDPOL)</li> </ul>
CAM_HD	I/O	HSYNC. This horizontal sync signal can be configured as an input or an output (VDHDOUT). <ul style="list-style-type: none"> <li>• When configured as an input, the CCD or CMOS sensor must supply the HD signal</li> <li>• When configured as an output, supplies the HD signal and the Hd width and pixels per line must be configured (HDW, PPLN)</li> <li>• The polarity of HD can be reversed (HDPOL)</li> </ul>
CAM_WEN_FIELD	I	Field identification signal (optional – FLDMODE) <ul style="list-style-type: none"> <li>• Supplied by the external CCD or CMOS sensor</li> <li>• Can be configured to be latched by the VD signal (FIDMD)</li> <li>• The polarity of the field identification signal can be reversed (FLDPOL)</li> </ul> CCD write enable signal (optional – EXWEN). This write enable signal determines when data is captured/processed/saved to memory or sent for further processing. <ul style="list-style-type: none"> <li>• If enabled (EXWEN), image data will only be captured/processed/saved to memory or sent for further processing depending on the state of WENLOG.</li> <li>• Data can be saved when either <math>\overline{C\_WE}</math> is active AND the pixels are within the internal frame (SPH, NPH, SLV, NLV) when either the <math>\overline{C\_WE}</math> signal is active; or data can be save only when <math>\overline{C\_WE}</math> is active OR the pixels are within the internal frame (WENLOG)</li> </ul>
PCLK	I	Pixel clock. This signal is used to load image data into the CCDC. <ul style="list-style-type: none"> <li>• The CCDC can be configured to capture on either the rising or falling edge of the PCLK signal (PCLK_INV in SYSTEM module)</li> </ul>

### 2.1.3 Parallel Generic Configuration (RAW) Protocol and Data Formats

As described in [Table 5](#), the device can be separately configured to either source or sink the VD/HD signals. If these signals are sourced, then the CCD/CMOS Controller must be configured via register settings for the proper timing generation. The definition of the captured frame must be set regardless of the control signal settings but these settings are described in the data processing section below.

#### 2.1.3.1 Mode Information – Always Required

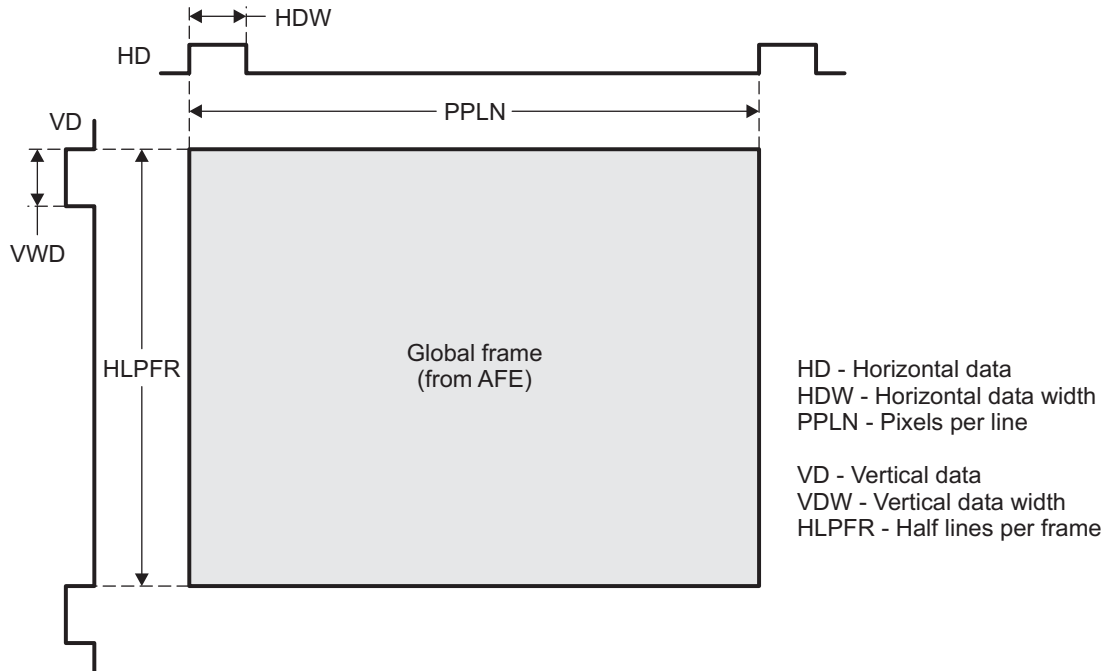
- INPMOD – input mode
- DATAPOL – polarity of input data
- VDPOL – Vd polarity
- HDPOL – Hd polarity
- VDHDOUT – Vd/Hd signal direction
- FLDMOD – Field mode

#### 2.1.3.2 Timing Information – Optional, Depending on Control Signals and Sensor Mode

- If FLDMODE is enabled
  - FLDPOL – polarity of CAM\_WEN\_FIELD signal for FIELD function
  - FIDMD – CAM\_WEN\_FIELD latch information
- If VDHDOUT is output
  - VDW – Vd width
  - HLPFR – Half lines per frame
  - HDW – Hd width
  - PPLN – Pixels per line
- EXWEN – external CAM\_WEN\_FIELD signal enabled for WEN function
  - WENLOG – determines when data is valid along with frame settings

The timing generator in the CCDC either enables the use of external sync signals (HD/VD) or internal generated timing signals. If timing signals are generated internally, the ARM can set the width, polarity, position and direction of internal generated signals. [Figure 4](#) shows various CCDC register settings related to the timing. The shaded area is the physical imager size.

Figure 4. Raw Mode Timing Diagram



The bits of data from each pixel are stored in the lower bits of a 16-bit SDRAM word, and the unused bit positions are filled with zeros. The DDR data format is shown in Figure 5. There is an optional 10-to-8-bit A-Law compression so that 10-bit data can be reduced to 8-bit dynamic range and packed to save DDR memory usage.

Figure 5. DDR2/mDDR controller Output Format

	Upper word		Lower word	
	MSB(31)	LSB(16)	MSB(15)	LSB(0)
14 bit	0	Pixel 1	0	Pixel 0
13 bit	0	Pixel 1	0	Pixel 0
12 bit	0	Pixel 1	0	Pixel 0
11 bit	0	Pixel 1	0	Pixel 0
10 bit	0	Pixel 1	0	Pixel 0
9 bit	0	Pixel 1	0	Pixel 0
8 bit	0	Pixel 1	0	Pixel 0
8 bit pack	Pixel 3	Pixel 2	Pixel 1	Pixel 0

## 2.2 ITU-R BT.656 Interface Configuration

ITU-R BT.656 (sometimes referred to as REC656) is a specification that provides a method to transfer YCbCr-4:2:2 formatted digital video data over an 8/10-bit wide interface. Note that the BT.656 specification is for 525-line and 625-line, digital component video signals in compliance with BT.601.

### 2.2.1 ITU-R BT.656 Configuration Signal Interface

Table 6 shows the interface connections for the ITU-R BT.656 interface.

Data and timing codes are transferred over the same 8/10-bit interface. When in BT.656 mode, only the data lines and clock signal are connected between the external device and the CCDC module of VPFE. An NTSC/PAL decoder is an example of an external device that may be connected to the REC656 interface.

Data lines CCD[7:0] are used for 8-bit YCbCr data and data lines CCD[9:0] are used for 10-bit YCbCr data. The video timing signals, HD, VD, and FIELD, are generated internally by the CCDC module of VPFE.

Note that an additional SPI can be supported in this mode without interference.

**Table 6. Interface Signals for ITU-R BT.656 Mode**

Pin Name	I/O	Description
PCLK	Bidi	Pixel Clock
GIO084	Bidi	GIO
GIO085	Bidi	GIO
SPI2_SCLK/GIO101	Bidi	Optional SPI signal or GIO
SPI2_SDO/GIO100	Bidi	Optional SPI signal or GIO
SPI2_SDEN A/GIO099	Bidi	Optional SPI signal or GIO
SPI2_SDENB/SPI2_SDI3/GIO098	Bidi	Optional SPI signal or GIO
GIO097	Bidi	GIO
GIO096	Bidi	GIO
CCD9/GIO095	Bidi	BT.656 Data (optional for 10-bit I/F)
CCD8/GIO094	Bidi	BT.656 Data (optional for 10-bit I/F)
CCD7	Bidi	BT.656 Data
CCD6	Bidi	BT.656 Data
CCD5	Bidi	BT.656 Data
CCD4	Bidi	BT.656 Data
CCD3	Bidi	BT.656 Data
CCD2	Bidi	BT.656 Data
CCD1	Bidi	BT.656 Data
CCD0	Bidi	BT.656 Data
GIO083	Bidi	GIO



### 2.2.2 ITU-R BT.656 Configuration Signal Interface Description

The REC656 interface supports either 8-bit or 10-bit processing if input Video YCbCr data. See the programming guide section for configuring this mode.

Since the sync information is carried along with the data lines, there are no sync signal interfaces or CCD controller configuration settings to make other than the start/end pixels and the line length and vertical frame size. The signal interface is described in [Table 7](#).

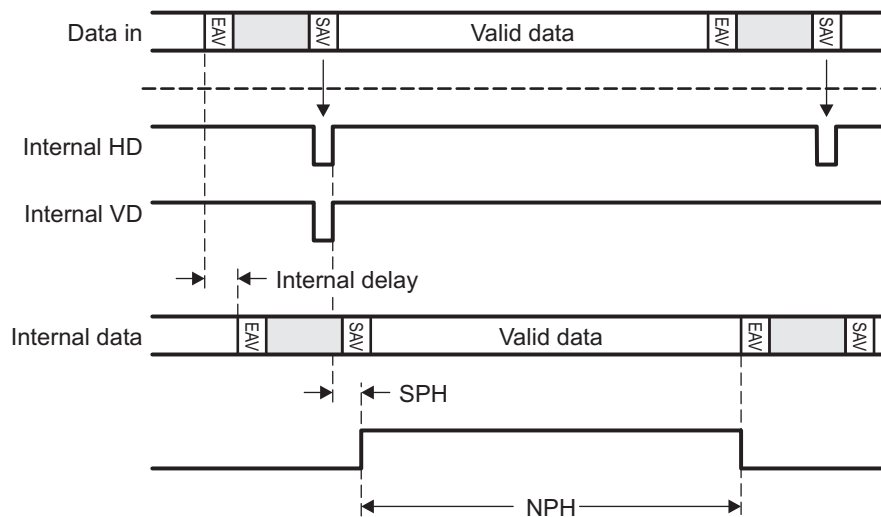
**Table 7. ITU-R BT.656 Interface Signals**

Name	I/O	Description
CCD[9:0]	I	Image Data, Mode set by R656ON <ul style="list-style-type: none"> <li>• Bit width can be configured to either 8 or 10 bits (BW656)</li> <li>• The polarity of the input image data can be reversed (DATAPOL)</li> </ul>
PCLK	I	Pixel clock. This signal is used to load image data into the CCDC. <ul style="list-style-type: none"> <li>• The CCDC can be configured to capture on either the rising or falling edge of the PCLK signal (PCLK_INV in SYSTEM module).</li> </ul>

### 2.2.3 ITU-R BT.656 Configuration Protocol and Data Formats

Two timing reference codes synchronize HD, VD, and FIELD to the video data. At the start and end of each video data block the device sends a unique timing reference code. The start code is called the Start of Active Video signal (SAV), and the end code is called the End of Active Video signal (EAV). The SAV and EAV codes proceed and follow valid data as shown in [Figure 6](#). HD, VD, and FIELD are generated internally by the CCDC based on the SAV and EAV codes. Other CCDC register settings allow the user to control when valid data will be read/saved to DDR2/mDDR controller.

**Figure 6. BT.656 Signal Interface**



Both timing reference signals, SAV and EAV, consist of a four word sequence in the following format: FF 00 00 XY, where FF 00 00 are a set preamble and the fourth word defines the field identification, the state of vertical field blanking, the state of horizontal line blanking, and protection (error correction) codes. The bit format of the fourth word is shown in [Table 8](#) and the definitions for bits, F, V, and H are given in [Table 9](#). F, V, and H are used in place of the usual horizontal sync, vertical sync, and blank timing control signals. Bits P3, P2, P1, and P0 are protection (error correction) bits for F, V, and H. The relationship between F, V, and H and the protection (error correction) bits is given in [Table 10](#). To enable error correction, set bit ECCFVH in the REC656IF register. The CCDC will automatically detect and apply error correction when ECCFVH is enabled.

**Table 8. Video Timing Reference Codes for SAV and EAV**

Data Bit Number	Data Bit Number	Second Word (00)	Third Word (00)	Fourth Word (XY)
9	1	0	0	1
8	1	0	0	F
7	1	0	0	V
6	1	0	0	H
5	1	0	0	P3
4	1	0	0	P2
3	1	0	0	01
2	1	0	0	P0
1	1	0	0	0
0	1	0	0	0

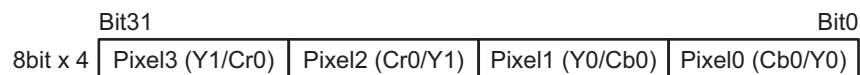
**Table 9. F, V, H Signal Descriptions**

Signal	Value	Command
F	0	Field 1
	1	Field 2
V	0	0
	1	Vertical blank
H	0	SAV
	1	EAV

**Table 10. F, V, H Protection (Error Correction) Bits**

F	V	H	P3	P2	P1	P0
0	0	0	0	0	0	0
0	0	1	1	1	0	1
0	1	0	1	0	1	1
0	1	1	0	1	1	0
1	0	0	0	1	1	1
1	0	1	1	0	1	0
1	1	0	1	1	0	0
1	1	1	0	0	0	1

When operating in REC656 mode, data is stored in SDRAM according to the format shown in [Figure 7](#).

**Figure 7. BT.656 Mode Data Format in SDRAM**


## 2.3 Generic YCbCr Interface Configuration

The CCD Controller can accept generic YCbCr-4:2:2 formatted digital video data over an 8/16 bit wide interface. Note that the BT.656 specification is for 525-line and 625-line, digital component video signals in compliance with BT.601.

### 2.3.1 Generic YCbCr Configuration Signal Interface

Table 11 shows the interface connections for the generic YCbCr interface.

Unlike the BT.656 mode, discrete HD, and VD signals are required. An NTSC/PAL decoder is an example of an external device that may be connected to the YCbCr interface.

In 8-bit mode, data lines YIN[7:0] and CIN[7:0] can be used for input. When using an 8-bit interface, the YIN[7:0] inputs are typically used. However, either set of data inputs can be used or, alternately, two separate imagers can be physically connected (but only one can be active at any given time, though). A register setting (CCDCFG.YCINSWP) determines which set of 8-bit inputs are active. Note that if only the lower 8 bits are used, an additional SPI can be supported in this mode without interference.

In 16-bit mode, data lines YIN[7:0] and CIN[7:0] are used for input with the Cr/Cb data multiplexed on the CIN[7:0] signals. A register setting (CCDCFG.YCINSWP) can be used to swap the Y and Cr/Cb data lines.

**Table 11. Interface Signals for Generic YCbCr Mode**

Pin Name	I/O	Description
PCLK	Bidi	Pixel Clock
CAM_VD	Bidi	V sync
CAM_HD	Bidi	H sync
CIN7/SPI2_SCLK/GIO101	Bidi	C IN signal
CIN6/SPI2_SDO/GIO100	Bidi	C IN signal
CIN5/GIO099 SPI2_SDENA	Bidi	C IN signal
CIN4/GIO098 SPI2_SDENB/SPI2_SDI3	Bidi	C IN signal
CIN3 / GIO097	Bidi	C IN signal
CIN2 / GIO096	Bidi	C IN signal
CIN1 / GIO095	Bidi	C IN signal
CIN0 / GIO094	Bidi	C IN signal
YIN7 / GIO093	Bidi	Y IN signal
YIN6 / GIO092	Bidi	Y IN signal
YIN5 / GIO091	Bidi	Y IN signal
YIN4 / GIO090	Bidi	Y IN signal
YIN3 / GIO089	Bidi	Y IN signal
YIN2 / GIO088	Bidi	Y IN signal
YIN1 / GIO087	Bidi	Y IN signal
YIN0 / GIO086	Bidi	Y IN signal
GIO083	Bidi	GIO

### 2.3.2 Generic YCbCr Configuration Signal Interface Description

The digital YCbCr interface supports either 8-bit or 16-bit devices. The signal interface is described in [Table 12](#).

**Table 12. Table 16. YCbCr Interface Signals**

Name	I/O	Description
CCD[15:0] = YI[7:0] / CI[7:0]	I	Image data. Mode set by INPMOD (not R656ON). <ul style="list-style-type: none"> <li>• Bit width can be configured between 8 and 16 bits (DATSIZ)</li> <li>• The polarity of the input image data can be reversed (DATAPOL)</li> <li>• When 16-bit interface is used, the Y and C inputs can be swapped (YCINSWP)</li> <li>• When 8-bit interface is used, either half of the bus can be connected (YCINSWP)</li> <li>• When 8-bit interface is used, the position of the Y data can be set to either the even or odd pixel (Y8POS)</li> </ul>
CAM_VD	I/O	VSYNC. This vertical sync signal can be configured as an input or an output (VDHDOUT). <ul style="list-style-type: none"> <li>• When configured as an input, the CCD or CMOS sensor must supply the VD signal</li> <li>• When configured as an output, supplies the VD signal and the Vd width and lines per frame must be configured (VDW, HLPFR)</li> <li>• The polarity of VD can be reversed. (VDPOL)</li> </ul>
CAM_HD	I/O	HSYNC. This horizontal sync signal can be configured as an input or an output (VDHDOUT). <ul style="list-style-type: none"> <li>• When configured as an input, the CCD or CMOS sensor must supply the HD signal</li> <li>• When configured as an output, supplies the HD signal and the Hd width and pixels per line must be configured (HDW, PPLN)</li> <li>• The polarity of HD can be reversed (HDPOL)</li> </ul>
CAM_WEN_FIELD	I	Field identification signal (optional – FLDMODE) <ul style="list-style-type: none"> <li>• Supplied by the external CCD or CMOS sensor</li> <li>• Can be configured to be latched by the VD signal (FIDMD)</li> <li>• The polarity of the field identification signal can be reversed (FLDPOL)</li> </ul>
PCLK	I	Pixel clock. This signal is used to load image data into the CCDC. <ul style="list-style-type: none"> <li>• The CCDC can be configured to capture on either the rising or falling edge of the PCLK signal (PCLK_INV in SYSTEM module)</li> </ul>

### 2.3.3 Generic YCbCr Configuration Protocol and Data Formats

In 8-bit mode, the position on the Y data in relation to Cr/Cb data can be configured by the register setting: `CCDCFG.Y8POS`.

The byte ordering of data can be swapped by the register setting: `CCDCFG.BSWD`.

**Table 13. DDR2/mDDR Controller Storage Format for YCbCr Processing**

SDRAM Address	Upper Word		Lower Word	
	MSB(31)	LSB(16)	MSB(15)	LSB(0)
N	Y1	Cr0	Y0	Cb0
N + 1	Y3	Cr2	Y2	Cb2
N + 2	Y5	Cr4	Y4	Cb4

## 2.4 VPFE I/O Multiplexing

The various VPFE Imager interfaces modes have unique pin multiplexing options as shown in [Table 14](#). Some of these settings are controlled in the System Module, described in detail in the *TMS320DM35x Digital Media System-on-Chip (DMSoC) ARM Subsystem Reference Guide (SPRUFB3)*. The remaining settings are controlled via the mode in which the controller is placed.

**Table 14. Signals for VPFE Digital Capture Modes**

Pin Name	Serial In	Parallel RAW	Parallel YCC16	Parallel YCC8	REC656
PCLK	GIO082	PCLK	PCLK	PCLK	PCLK
CAM_VD	GIO084	VD	VD	VD	GIO084
CAM_HD	GIO085	HD	HD	HD	GIO085
CIN7	SPI2_SCLK/ GIO101	SPI2_SCLK/ GIO101	C7/Y7	Y7,Cb7,Cr7/ SPI2_SCLK/ GIO101	SPI2_SCLK/ GIO101
CIN6	SPI2_SDO/ GIO100	SPI2_SDO/ GIO100	C6/Y6	Y6,Cb6,Cr6/ SPI2_SDO/ GIO100	SPI2_SDO/ GIO100
CIN5	GIO099/ SPI2_SDENA	D[13]/GIO099/ SPI2_SDENA	C5/Y5	Y5,Cb5,Cr5/ SPI2_SDENA/ GIO099	SPI2_SDENA/ GIO099
CIN4	GIO098/ SPI2_SDENB/ SPI2_SDI3	D[12]/GIO098/ SPI2_SDEN/ PI2_SDI3	C4/Y4	Y4,Cb4,Cr4/ SPI2_SDENB/ SPI2_SDI3/ GIO098	SPI2_SDENB/ SPI2_SDI3/ GIO098
CIN3	GIO097	D[11]	C3/Y3	Y3,Cb3,Cr3	GIO097
CIN2	GIO096	D[10]	C2/Y2	Y2,Cb2,Cr2	GIO096
CIN1	GIO095	D[9]	C1/Y1	Y1,Cb1,Cr1	Y9,Cb9,Cr9
CIN0	GIO094	D[8]	C0/Y0	Y0,Cb0,Cr0	Y8,Cb8,Cr8
YIN7	GIO093	D[7]	Y7/C7	Y7,Cb7,Cr7	Y7,Cb7,Cr7
YIN6	GIO092	D[6]	Y6/C6	Y6,Cb6,Cr6	Y6,Cb6,Cr6
YIN5	GIO091	D[5]	Y5/C5	Y5,Cb5,Cr5	Y5,Cb5,Cr5
YIN4	GIO090	D[4]	Y4/C4	Y4,Cb4,Cr4	Y4,Cb4,Cr4
YIN3	GIO089	D[3]	Y3/C3	Y3,Cb3,Cr3	Y3,Cb3,Cr3
YIN2	GIO088	D[2]	Y2/C2	Y2,Cb2,Cr2	Y2,Cb2,Cr2
YIN1	GIO087	D[1]	Y1/C1	Y1,Cb1,Cr1	Y1,Cb1,Cr1
YIN0	GIO086	D[0]	Y0/C0	Y0,Cb0,Cr0	Y0,Cb0,Cr0
CAM_WEN_FIELD	GIO083	WEN/FIELD/ GIO083	WEN/FIELD/ GIO083	WEN/FIELD/ GIO083	GIO083

### 2.4.1 SPI and GIO Signal Multiplexing

The SPI2 peripheral and several GIOs may be made available to the system depending on the pin usage of the particular capture mode used by the VPFE. [Table 14](#) shows which pins are required by the VPFE for particular image capture modes and which pins can be made available for use by the SPI2 peripheral and/or extra GIOs. The PINMUX0 register shown in [Table 14](#) must be programmed according to the appropriate capture mode.

### 2.4.2 Y/C Data BUS Swap

There is an option to swap the upper and lower portion of the 16-bit YCbCr data bus (CCDC.CCDCFG.YCINSWP). This will swap the luma and chroma samples in 16-bit YCbCr mode. This will determine which half of the bus is used as the input source in 8-bit mode and can be used in 8-bit YCbCr mode to support two separate YCbCr input ports.

### 2.4.3 WEN/FIELD Signal Selection

Since the field ID and the write enable signal share the same pin, only one of these external signals can be connected. To enable the FIELD ID input, bit-5 of the CCDC.MODESET register should be set to INTERLACE MODE. To enable the write enable (WEN) signal, bit-7 of CCDC.MODESET register should be set. These two bits should not be set concurrently or indeterminate results may occur.

### 2.4.4 Pin Mux 0 Register (PINMUX0)

The PINMUX0 register controls pin multiplexing for the VPFE pins. The pin mux 0 register (PINMUX0) is shown in Figure 8 and described in Table 15. The address for this register is 0x01C4:0000.

**Figure 8. Pin Mux 0 Register (PINMUX0)**

Reserved							
R-0							
31							16
15	14	13	12	11	10	9	8
Reserved	PCLK	CAM_WEN_FIELD	CAM_VD	CAM_HD	YIN_70	CIN_10	CIN_32
R-0	R/W-0	R/W-0	R/W-0	R/W-0	R/W-0	R/W-0	R/W-0
7	6	5	4	3	2	1	0
CIN_4		CIN_5		CIN_6		CIN_7	
R/W-0		R/W-0		R/W-0		R/W-0	

LEGEND: R/W = Read/Write; R = Read only; -n = value after reset

**Table 15. Pin Mux 0 Register (PINMUX0) Field Descriptions**

Bit	Field	Value	Description
31-15	Reserved	0	Reserved
14	PCLK		PCLK pin function
		0	GIO082
		1	PCLK
13	CAM_WEN_FIELD		CAM_WEN_FIELD pin function
		0	GIO083
		1	CAM_WEN_FIELD
12	CAM_VD		CAM_VD pin function
		0	GIO084
		1	CAM_VD
11	CAM_HD		CAM_HD pin function
		0	GIO085
		1	CAM_HD
10	YIN_70		YIN0 – YIN7 pin functions
		0	GIO086, GIO087, GIO088, GIO089, GIO090, GIO091, GIO092, GIO093
		1	YIN0, YIN1, YIN2, YIN3, YIN4, YIN5, YIN6, YIN7
9	CIN_10		CIN0 & CIN1 pin functions
		0	GIO094, GIO095
		1	CIN2, CIN3
8	CIN_32		CIN2 & CIN3 pin functions
		0	GIO096, GIO097
		1	CIN2, CIN3

**Table 15. Pin Mux 0 Register (PINMUX0) Field Descriptions (continued)**

Bit	Field	Value	Description
7-6	CIN_4	0-3h 0 1h 2h 3h	CIN4 pin function GIO098 CIN4 SPI2_SDI3 SPI2_SDENB
5-4	CIN_5	0-3h 0 1h 2h 3h	CIN5 pin function GIO099 CIN5 SPI2_SDENA Reserved
3-2	CIN_6	0-3h 0 1h 2h 3h	CIN6 pin function GIO100 CIN6 SPI2_SDO Reserved
1-0	CIN_7	0-3h 0 1h 2h 3h	CIN7 pin function GIO101 CIN7 SPI2_SCLK Reserved

### 3 VPFE/ISP Integration

This section describes how the VPFE/ISP subsystem is integrated, including any interactions it may have with other subsystems on the device.

#### 3.1 Clocking, Reset and Power Management Scheme

##### 3.1.1 Clocks

There are five clock domains in the VPFE:

**Table 16. Clock Domains**

Name	Frequency	Description
MMR	PLL1/4	Used for clocking the memory-mapped register (MMR) port for the control registers
DMA	PLL1/4	Used for clocking the DMA port for data transfers to and from the DDR2/mDDR controller.
VPSSCLK	PLL1/(2 or 4)	Used for clocking the VPFE module internal logic. This is programmable in the PLL1 controller. The VPSSCLK divider should be programmed such that the VPSSCLK < 144MHz. Please reference the PLLC documentation for information on configuring this clock.
Parallel	< VPSSCLK/2	If the CCDC receives data via the parallel imager interface: this is the external pixel clock (PCLK) driven by the imager. This must be < VPSSCLK/2

Note that there is an option to drive the VPBE module with the VPFE pixel clock (PCLK).

##### 3.1.2 Resets

The VPFE module resets are tied to the device reset signals.

In addition, the VPSS modules can be reset by transitioning to the SyncReset state of the PSC. Note that the VPSS has two module domains, the VPSSmstr processing domain and the VPSSslv register interface.

##### 3.1.3 Power Management

When powered, the VPFE modules utilize auto clock gating on a clock-by-clock basis to conserve dynamic power during periods of inactivity. When the VPSS is not required for the application, its MMR clocks (VPSSslv) and operating clocks (VPSSmstr) can be gated by the Power Sleep Controller (PSC) to conserve dynamic power.

Additionally, when certain sub-modules within the VPFE are not required for the application mode, they can be disabled by software by configuring the VPSSCLK.CLKCTRL register appropriately.



### 3.2 Hardware Requests

The VPSS can generate the 13 interrupts/events shown in [Table 17](#). However, only nine of them can be sent to the ARM as interrupts and four of them can be sent to the EDMA as events. A mapping of which events are sent to the ARM and EDMA can be configured in the VPSSBL.INTSEL and VPSSBL.EVTSEL registers. The VPSSBL.INTSTAT register can also be used to poll for events. More details on each module's events can be found in [Section 5](#).

**Table 17. VPSS Events**

Event Number	Acronym	Module	Description
0	CCDC VDINT0	CCDC	Triggered after a programmable number of input lines for each frame.
1	CCDC VDINT1	CCDC	Triggered after a programmable number of input lines for each frame.
2	CCDC VDINT2	CCDC	Triggered at the rising edge of WEN signal
3	H3AINT	H3A	Triggered at the end of AF or AEW writes to DDR for each frame
4	VENCINT	VENC	Triggered at the rising edge of VSYNC
5	OSDINT	OSD	Triggered at the end of each frame read from DDR
6	IPIPEIFINT	IPIPEIF	Triggered at the rising edge of VD if enabled
7	IPIPE_INT0_HST	IPIPE	Triggered when Histogram processing is finished for each frame
8	IPIPE_INT1_SDR	IPIPE	Triggered when writes to DDR are finished for each frame
9	IPIPE_INT2_RZA	IPIPE	Triggered when the number of lines programmed has been output of RZA
10	IPIPE_INT3_RZB	IPIPE	Triggered when the number of lines programmed has been output of RZB
12	IPIPE_INT5_MMR	IPIPE	Triggered when MMR modifications for the next frame can be made

#### 3.2.1 Interrupt Requests

The 9 interrupts selected in the VPSSBL.INTSEL and VPSSBL.EVTSEL registers are assigned to the ARM interrupt controller as shown in [Table 18](#).

**Table 18. ARM Interrupts - VPSS**

INT Number	Acronym
0	VPSSINT0
1	VPSSINT1
2	VPSSINT2
3	VPSSINT3
4	VPSSINT4
5	VPSSINT5
6	VPSSINT6
7	VPSSINT7
8	VPSSINT8

### 3.2.2 EDMA Requests

The four events selected in the VPSSBL.EVTSEL register are assigned to the EDMA as shown in [Table 19](#).

**Table 19. EDMA Events - VPSS**

Event Number	Binary	Event Name
4	0000100	VPSSEVT1
5	0000101	VPSSEVT2
6	0000110	VPSSEVT3
7	0000111	VPSSEVT4

The primary reason for using an EDMA event from the VPSS is to allow for an update of the module registers by using the DMA scheme vs. direct CPU write. Normally, the ARM performs this function, but in some cases the ARM can be tied up with other activities and the interrupt latency is critical when dealing with the VPFE modules. Consider the following example: a still image is processed by the Image Pipe. Since the still image is too wide for a single pass through the Image Pipe, several passes are required. The Image Pipe registers need to be altered as soon as each pass is complete. Tying an IPIPE event to the EDMA allows instantaneous DMA of the new register settings for the subsequent passes.

### 3.3 VPSS Top-Level Register Mapping Summary

**Table 20. VPFE Module Register Map**

VPSS Registers	Address Range		Size
VPSSCLK	0x01C70000	0x01C7007F	128B
H3A	0x01C70080	0x01C700FF	128B
IPIPEIF	0x01C70100	0x01C701FF	256B
OSD	0x01C70200	0x01C702FF	256B
VENC	0x01C70400	0x01C705FF	512B
CCDC	0x01C70600	0x01C707FF	512B
VPSSBL	0x01C70800	0x01C708FF	256B
IPIPE	0x01C71000	0x01C73FFF	12K

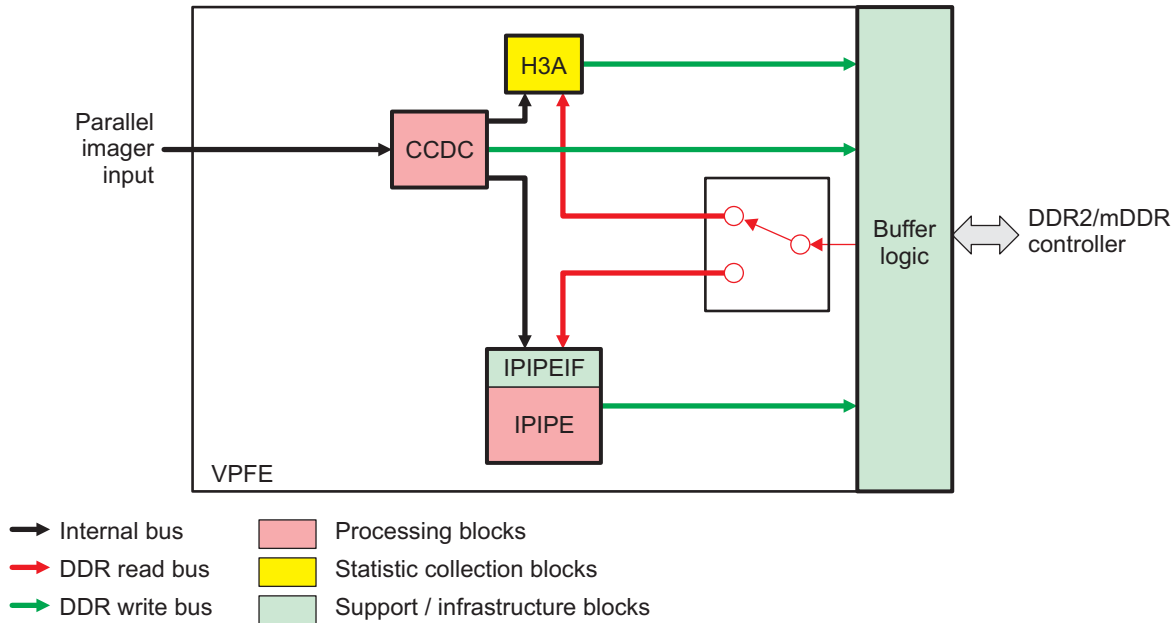
### 3.4 VPFE/ISP Top-Level Signal Interaction

In the system, the CCDC\_VD signal drives the event-trigger input signal of all four PWM modules. The PWM can configure the trigger to detect the rising or falling edge of the CCDC\_VD signal. This capability is provided to allow the PWM module to be used as a CCDC timer.

#### 4 VPFE/ISP Functional Description

The VPFE block diagram is shown in Figure 9. Additional detailed block diagrams are shown in the interface and image processing sub-sections.

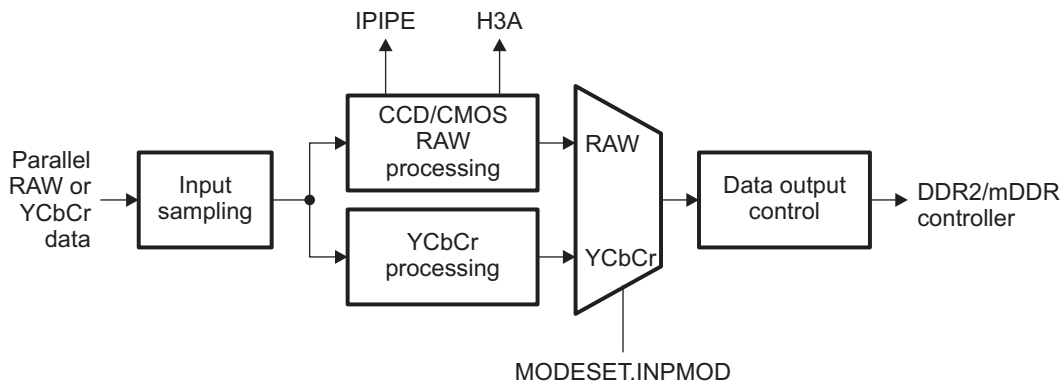
Figure 9. Video Processing Front End (VPFE) Block Diagram



#### 4.1 CCD/CMOS Controller (CCDC)

The CCD Controller interfaces with external image sources, not just CCD sensors. It supports both RAW Bayer data from CCD/CMOS sensors and processed YCbCr data from either a CMOS sensor with integrated image processing or a Video Decoder interface. A high-level block diagram of the CCD Controller is shown in Figure 10.

Figure 10. CCD Controller – Top Level Block Diagram

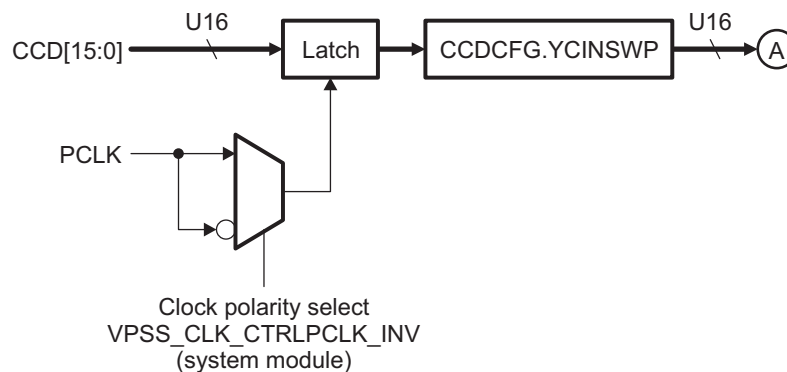


### 4.1.1 CCDC Input Sampling

The CCD/CMOS Controller input sampling and formatting is shown in [Figure 11](#).

- Data is latched by the pixel clock
- Pixel clock polarity can be either rising or falling edge. This is set in the system module via the register.field: VPSS\_CLK\_CTRL.PCLK\_INV
- There is an option to swap the upper and lower portion of the 16-bit YCbCr data bus (CCDCFG.YCINSWP). This will swap the luma and chroma samples in 16-bit YCbCr mode. This will determine which half of the bus is used as the input source in 8-bit mode and can be used in 8-bit YCbCr mode to support two separate YCbCr input ports. Since this bit affects both RAW and YCbCr input modes, CCDCFG.YCINSWP should always be set to 0 in RAW input mode (MODESET.INPMOD= 0) .

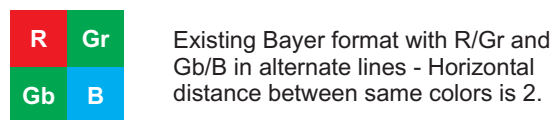
**Figure 11. CCD Controller – Input Formatting**



### 4.1.2 CCD/CMOS RAW Data Processing

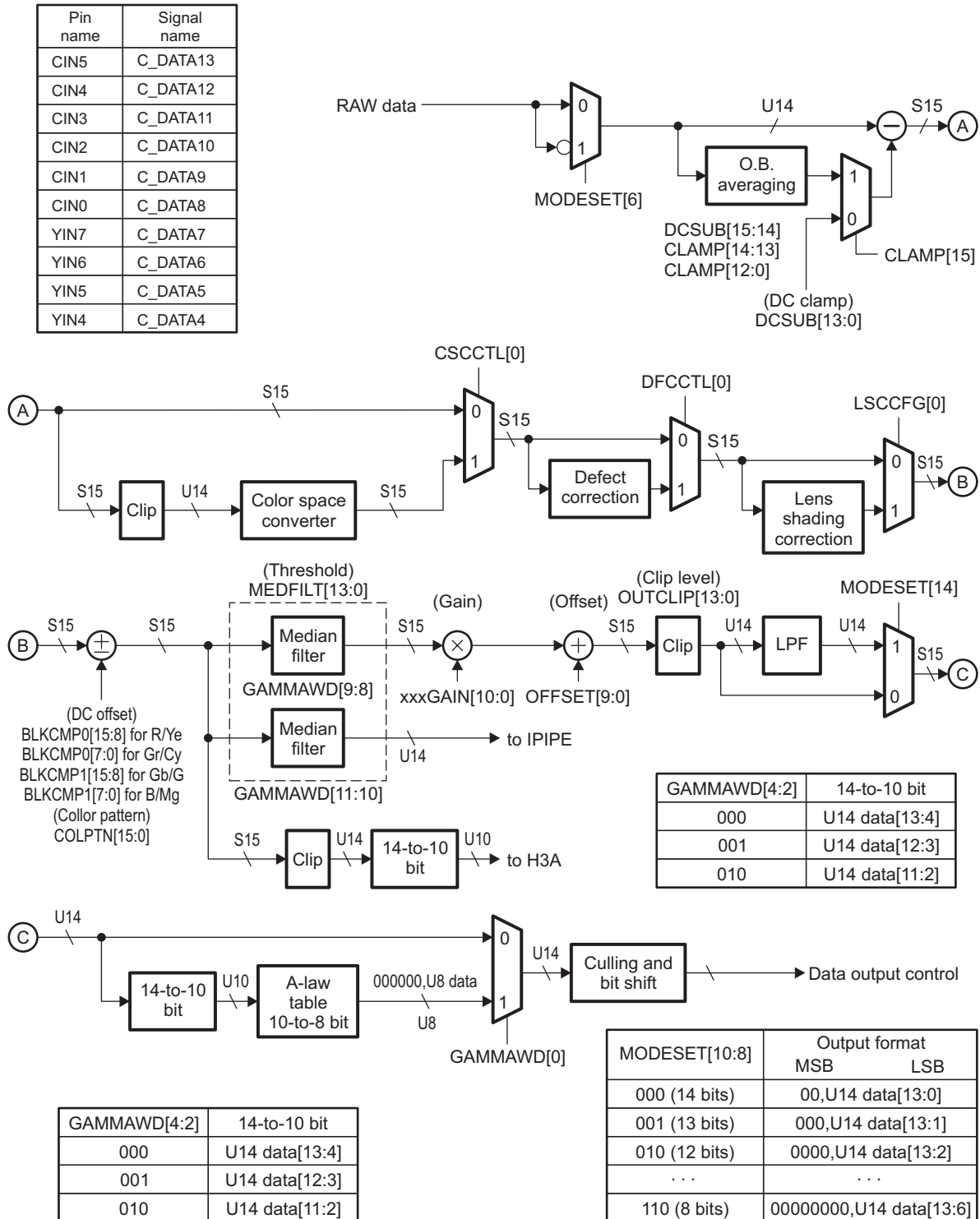
The following sections describes the CCD controller processing for the CCD/CMOS RAW data input mode (MODESET.INPMOD = 0 && REC656IF.REC656ON = 0) in more detail. In this mode, RAW sensor data, typically one color per pixel in a color filter array (or CFA) at 8 to 6-bits in dynamic range is input (usually between 10-14 bits). The color filter array applied is typically a Bayer pattern as show below for RGB color space. Complementary (Yellow, Cyan, Green, and Magenta) color filters are also supported via the color space converter.

**Figure 12. CCD Controller Color Patterns**



[Figure 13](#) shows the data flow of the CCD/CMOS RAW data processing. The first optional operation of the RAW data flow is data inversion. Data can be interpreted as either normal or inverted by setting the MODESET.DATAPOL register field.

Figure 13. CCD/CMOS Controller RAW Data Processing Flow



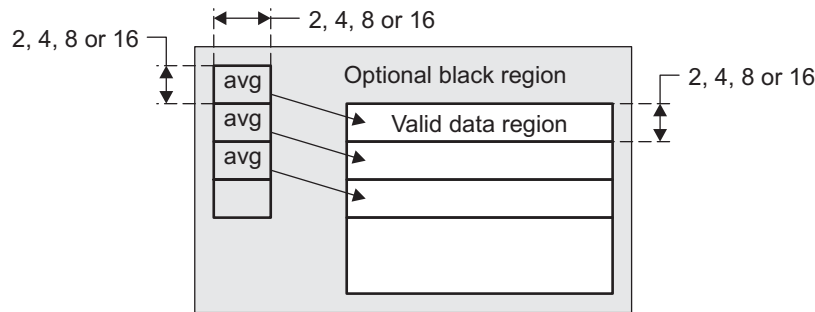
#### 4.1.2.1 Digital Clamp

Sensor manufacturers typically provide some optically masked pixels at the beginning/end of each line to allow the user to determine the noise floor on any given frame of data. The optical black clamping function provides a means to average the optically black pixels and subtract that value from each input pixel as a first step in reducing the noise on the input pixels.

The averaging circuit takes an average of masked (black) pixel values from the image sensor and this value is subtracted from the image data in the next `DCSUB.OBSLN` number of lines. The user can control the starting position of the black pixels (`CLAMP.OBST`), the number of pixels (2, 4, 8, or 16) in each line averaged (`CLAMP.OBSLEN`), and the number of lines (2, 4, 8, or 16) averaged (`DCSUB.OBSLN`).

Alternately, the user can disable black clamp averaging (`CLAMP.CLAMPEN`), and select a constant black value for subtraction (`DCSUB.DCSUB`), instead of using the calculated average value.

**Figure 14. CCD Controller Optical Black Averaging and Application**



#### 4.1.2.2 Color Space Conversion

Color space converter (CSC) includes four  $8\text{-bit} \times 10\text{-bit}$  multipliers and one adder for the color space conversion. These multiplier/adder units are used for the operation described in Figure 15. Data are taken from two input lines during the operation.

**Figure 15. Color Space Converter Functional Block Diagram**

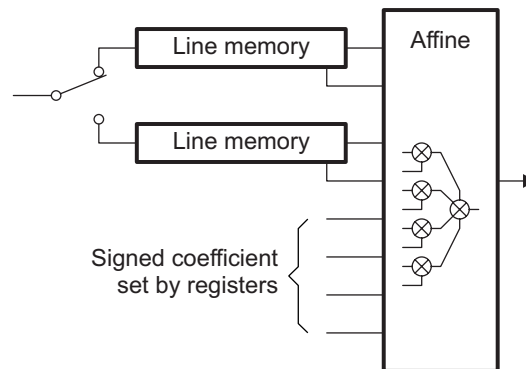
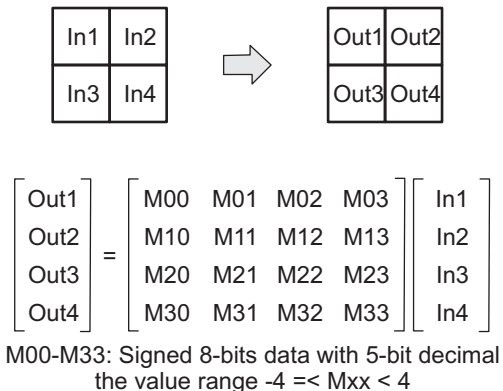
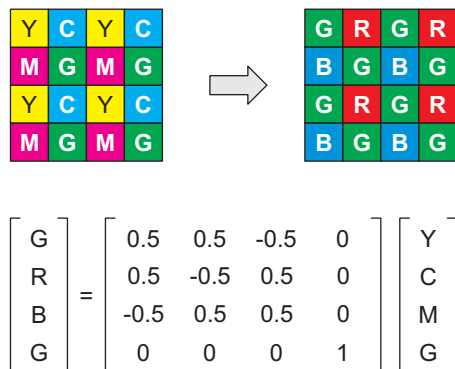


Figure 16. Color Space Converter Operation



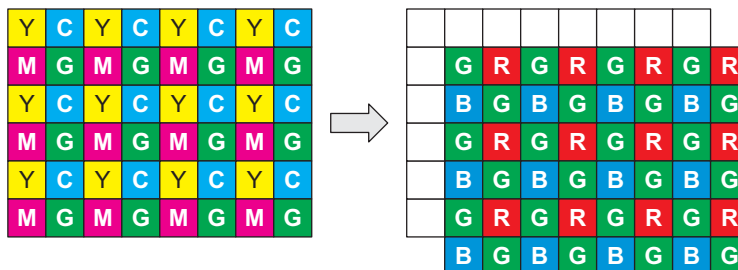
Coefficients are signed 8-bit (decimal is 5-bits). The CSC can convert CMYG filtered CCD data to Bayer matrix (RGBG) data as shown in Figure 17.

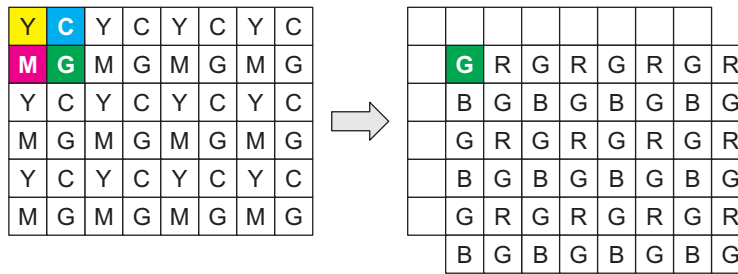
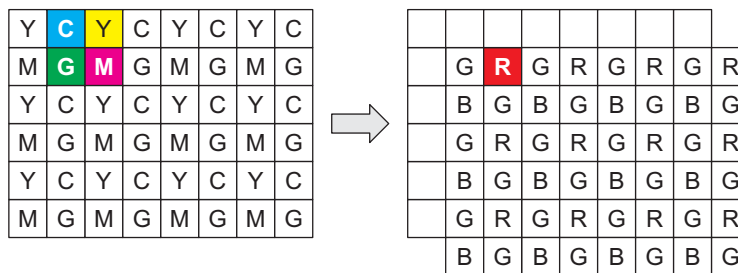
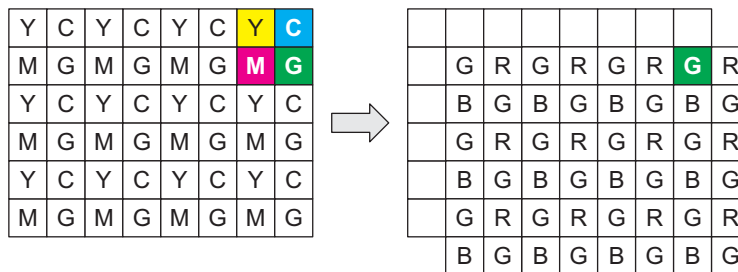
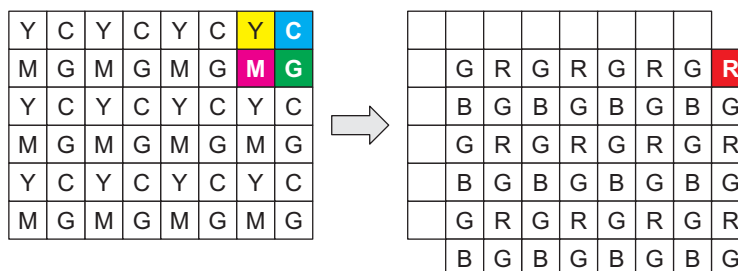
Figure 17. Color Space Converter Operation



The following figures explain which input pixels are used for the operation. There is a one-line latency between the input and the output. In addition to the registers specific to the color space converter, the following registers are needed to configure the valid area: FMTSPH, FMTLNH, FMTSLV, and FMTLNV. There should be at least one invalid pixel at the end of the line, and also one invalid line at the end of the frame.

Figure 18. Color Space Conversion

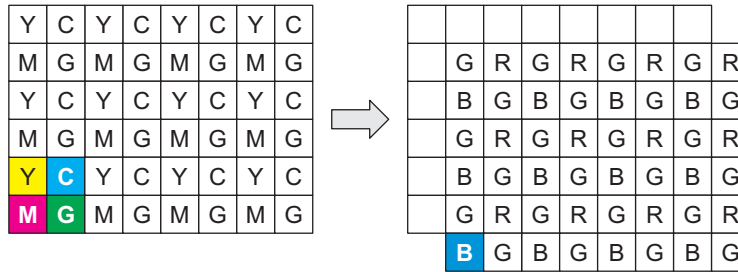


**Figure 19. First Pixel/First Line Generation**

**Figure 20. Second Pixel/First Line Generation**

**Figure 21. Second Last Pixel/First Line Generation**

**Figure 22. Last Pixel/First Line Generation**


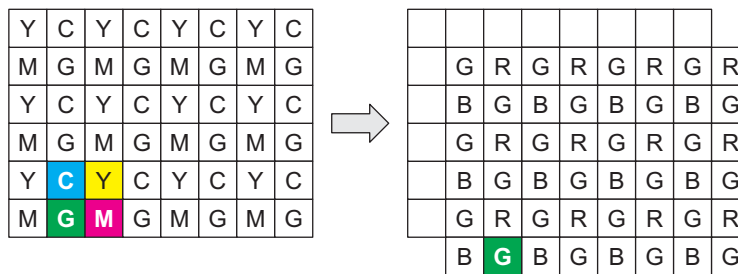
As shown in [Figure 21](#) and [Figure 22](#), the operation for the last pixel and the second to last pixel uses the same input data. Also the operation for the last line and the second to last line uses the same input data.



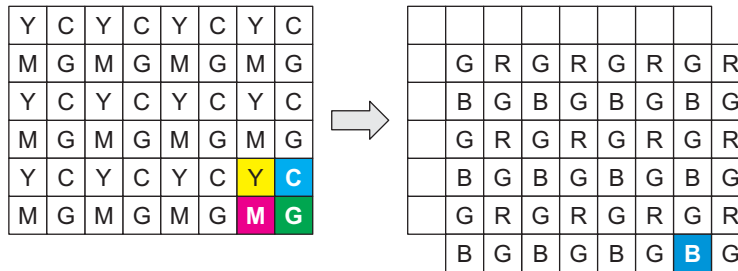
**Figure 23. First Pixel/Last Line Generation**



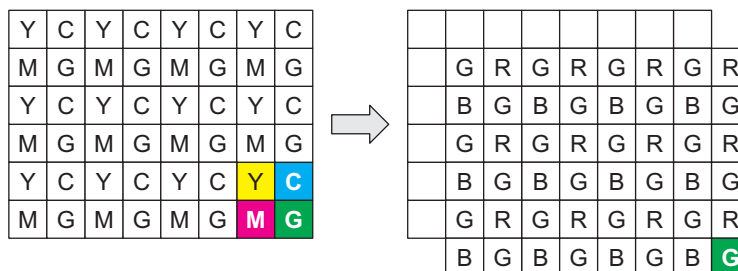
**Figure 24. Second Pixel/Last Line Generation**



**Figure 25. Second Last Pixel/Last Line Generation**



**Figure 26. Last Pixel/Last Line Generation**



**4.1.2.3 Defect Correction**

The defect correction block can correct up to 1,024 defects. The coordinates of the defects need to be set to the memory prior to the processing using the IPIPE registers: RAM\_ADR & RAM\_WDT. If the current pixel (I) is identified as a defect, it will be replaced by the average of pixel (I - 2) and pixel (I + 2), or just copied from (I - 2) or (I + 2). This block can also correct up to 16 vertical line defects.

#### 4.1.2.4 Lens Shading Correction

Some optics show significant Lens Shading, the phenomenon that the image is bright in the center and decrease in brightness towards the edge of the field. To compensate this effect, each pixel's illumination is controlled according to the distance from the optical center. The shading correction is performed on a color-by-color basis.

#### 4.1.2.5 Black Level Compensation

In this operation, a fixed offset can be applied to the data depending on the color; i.e., R/Ye, Gr/Cy, Gb/G, and B/Mg. The offset (BLKCMPO.R\_YE, BLKCMPO.GR\_CY, BLKCMPI.GB\_G, BLKCMPI.B\_MG), applied to each data sample is selected according to the even/odd phase and the color (0/1/2/3) specified for each pixel position (COLPTN).

#### 4.1.2.6 Median Filter

The median filter block has two separate filters: one for the output to SDRAM, and another for the output to IPIPE. Each of these filters can be individually disabled, enabled as an average filter, or enabled as a median filter (GAMMAWD.MFILT1 and GAMMAWD.MFILT2).

##### 4.1.2.6.1 Average Filter Configuration

The average filter calculates the absolute difference between the current pixel (I) and the pixel (I - 2), and between the current pixel (I) and the pixel (I + 2). If the absolute differences exceeds the threshold (MEDFILT.MFTHR), the average of pixel (I - 2) and pixel (I + 2) replaces pixel (I). Filter's threshold is configurable and the filter can be either enabled or disabled.

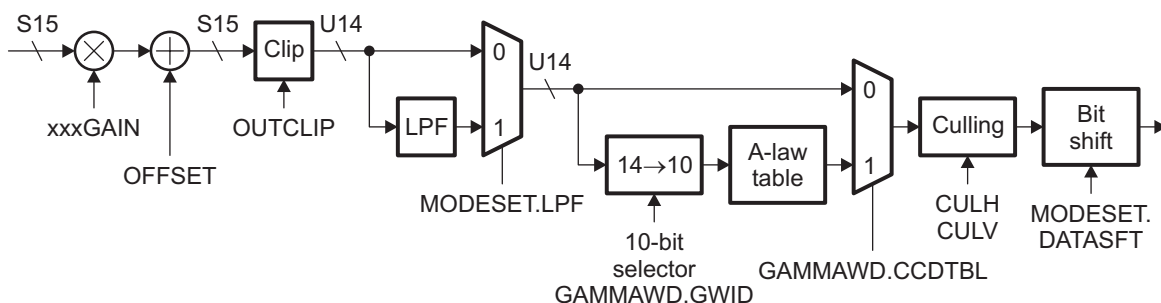
##### 4.1.2.6.2 Median Filter Configuration

The median filter corrects the current pixel if it differs from both same-color neighbors by more than a programmable threshold. If the pixel is faulty, it is replaced by the median of the 3 pixels.

#### 4.1.2.7 SDRAM RAW Output Formatting

The final stage of the CCD/CMOS RAW data processing is the SDRAM RAW output formatter, as shown in Figure 27. This module includes separate color gains, offset, clip, optional low-pass filtering, a-law compression, culling, and a final bit shift of the data being stored to SDRAM.

**Figure 27. Output Formatter Functional Model**



**4.1.2.7.1 Gain, Offset, and Clip**

A gain factor from 0 to 7.9921875 can be applied separately to each color of the output of the median filter for SDRAM output (RYEGAIN, GRGYGAIN, GBGGAIN, and BMGGAIN). After multiplying the data by the gain factor, a single offset value can be added to the result (OFFSET). The offset can range from 0 to 1023. The result of gain control is clipped to signed 15-bit data after offset control. The output can additionally be clipped to a user programmed value (OUTCLIP), which is defaulted to unsigned 14-bit data.

**4.1.2.7.2 Low Pass Filter**

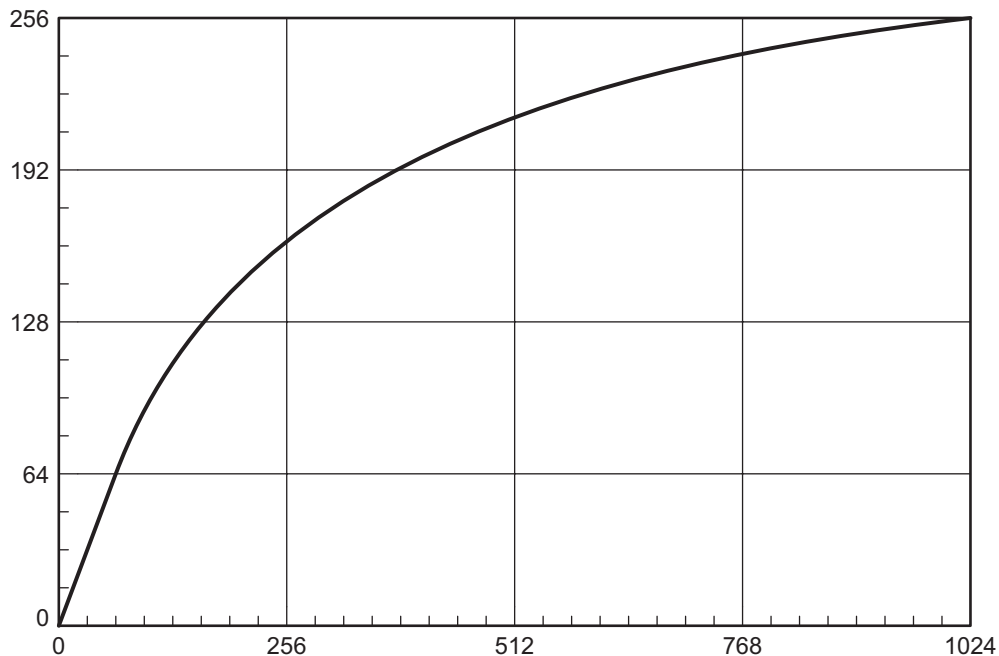
The output formatter block provides an option for applying an anti-aliasing filter (MODESET.LPF) for bandwidth reduction if horizontal culling is enabled. The low-pass filter consists of a simple three-tap (1/4, 1/2, 1/4) filter. Two pixels on the left and two pixels on the right of each line are cropped if the filter is enabled.

**4.1.2.7.3 A-Law Transformation**

An optional 10-to-8-bit A-Law transformation using a fixed A-Law table can be applied (GAMMAWD.CCDTBL) to the LPF output. Using this causes the data width to be reduced to 8-bits and allows packing to 8-bits/pixel when saving to DDR2/mDDR controller for buffer memory reduction. Since the data resolution is greater than 10-bits at this stage, the 10-bits for input to the A Law operation must be selected (GAMMAWD.GWID). The A-law table has a same characteristic as the Voice codec and is shown in Figure 28.

Note that IPIPEIF has an inverse A-Law table option so it can reverse this non-linear operation if this saved data is to be read back in for further processing.

**Figure 28. A-Law Table**



#### 4.1.2.7.4 Culling

The culling module performs a programmable decimation function for both horizontal and vertical directions.

The horizontal and vertical decimation of CCD data can be controlled by two registers. The 16-bit CULH register specifies the horizontal culling pattern for even and odd lines. The 8-bit CULV register specifies the pattern for the vertical direction. The LSB of CULV represent the top line of the CCD, the MSB is the seventh line.

Figure 29 is an example showing how CULH and CULV apply a decimation pattern to the data. The shaded pixels are transferred to SDRAM. In this case:

- CULH.CULHEVN = 0x59
- CULH.CULHODD = 0xC4, and
- CULV.CULV = 0x66

**Figure 29. Example for Decimation Pattern**

	LSB							MSB		
CULHEVEN	0	0	1	0	0	0	1	1		
CULHODD	1	0	0	1	1	0	1	0		

	CULLV								
0 <sup>th</sup> line									0
1 <sup>st</sup> line									1
2 <sup>nd</sup> line									1
3 <sup>rd</sup> line									0
4 <sup>th</sup> line									0
5 <sup>th</sup> line									1
6 <sup>th</sup> line									1
7 <sup>th</sup> line									0

#### 4.1.2.7.5 Bit Shift

The final stage in the CCD/CMOS RAW data output formatter is a bit shift function. The `MODESET.DATASFT` field can be programmed to right-shift the RAW data to be stored to SDRAM up to 6 bits.

#### 4.1.2.8 SDRAM Data Storage

The data bits comprising each pixel are stored in the lower bits of a 16-bit SDRAM word and the unused bits are zero-filled. The SDRAM data format is shown in Figure 30, with the format used determined by the `MODESET.DATASFT` setting for all but the packed format. If 8-bit data is input, or if the A-Law compression is applied in RAW input mode, the data can be packed via the `MODESET.PACK8` setting so that a pixel will only occupy 8-bits.

**Figure 30. SDRAM Output Format**

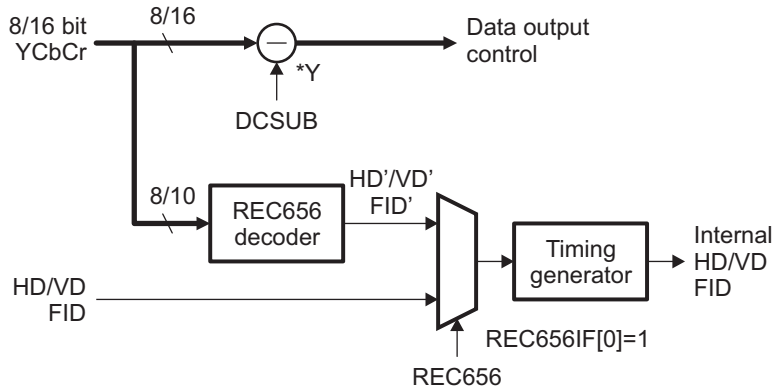
	Upper word		Lower word	
	MSB(31)	LSB(16)	MSB(15)	LSB(0)
14 bit	0	Pixel 1	0	Pixel 0
13 bit	0	Pixel 1	0	Pixel 0
12 bit	0	Pixel 1	0	Pixel 0
11 bit	0	Pixel 1	0	Pixel 0
10 bit	0	Pixel 1	0	Pixel 0
9 bit	0	Pixel 1	0	Pixel 0
8 bit	0	Pixel 1	0	Pixel 0
8 bit pack	Pixel 3	Pixel 2	Pixel 1	Pixel 0

### 4.1.3 YCbCr Data Processing

The following sections describe the CCD controller processing for the YCbCr data input mode (MODESET.INPMOD = 1 or 2 || REC656IF.REC656ON = 1) in more detail. In this mode, YCbCr 4:2:2 data typically at 8-bits per luma/chroma sample is input.

Figure 31 shows the data flow of the YCbCr data processing.

Figure 31. CCD/CMOS Controller YCbCr Data Processing Flow



#### 4.1.3.1 DC Subtract

An offset can optionally be subtracted from the luma (Y) component of the data by programming the DCSUB.DCSUB register field. Please note that in YCbCr processing, the CLAMP.CLAMPEN field must be disabled 0 or indeterminate results may occur.

#### 4.1.3.2 REC656 Mode

Processing of the data in REC656 mode is identical to that of the other YCbCr modes; however, there is an additional decoder block that extracts the sync information from the data signal and generates the HD/VD/Field signals for downstream processing. Data at 10-bit resolution is reduced to 8 bits before being saved to SDRAM.

#### 4.1.3.3 SDRAM Data Storage

In packed YCbCr 4:2:2 mode, data is stored in SDRAM with two pixels per 32 bits, as shown in Table 21. If the input mode is not 16 bits, then this packing of data must be achieved by setting the MODESET.PACK8 bit.

Table 21. YCbCr Mode SDRAM Output Format

SDRAM Address	Upper Word		Lower Word	
	MSB(31)	LSB(16)	MSB(15)	LSB(0)
N	Y1	Cr0	Y0	Cb0
N + 1	Y3	Cr1	Y2	Cb1
N + 2	Y5	Cr2	Y4	Cb2

#### 4.1.4 Data Output Control

Data output to SDRAM is enabled via the `MODESET.WEN` setting.

The MSB of the chroma signal can also be inverted (`CCDCFG.MSBINVI`).

The CCD/CMOS Controller's final stage is the Line Output Control, which controls how the input lines are written to DDR2/mDDR controller. The values `SRADRH` and `SRADRL` define the starting address where the frame should be written in SDRAM. The value `HSIZE.LNOFST` defines the distance between the beginning of output lines, in bytes. Both the starting address and line offset values are programmed in 32-byte units; i.e., either 16 or 32 pixels, depending on the `MODESET.PACK8` setting. The `HSIZE.ADR_UPDT` register bit can be set to decrement the addresses across each line to invert an image horizontally. The register `SDOFST` can be used to define additional offsets depending on the Field ID and even/odd line numbers. This provides a means to de-interlace an interlaced, 2-field input and also to invert an input image vertically. See [Figure 32](#) and [Figure 33](#) for some example usage.

- `SDOFST.FIINV` – invert interpretation of the Field ID signal
- `SDOFST.FIINV` – invert interpretation of the Field ID signal
- `SDOFST.LOFTS0` – offset, in lines, between even lines on even fields (field 0)
- `SDOFST.LOFTS1` – offset, in lines, between odd lines on even fields (field 0)
- `SDOFST.LOFTS2` – offset, in lines, between even lines on odd fields (field 1)
- `SDOFST.LOFTS3` – offset, in lines, between odd lines on odd fields (field 1)

**Figure 32. Frame Image Format Conversion**

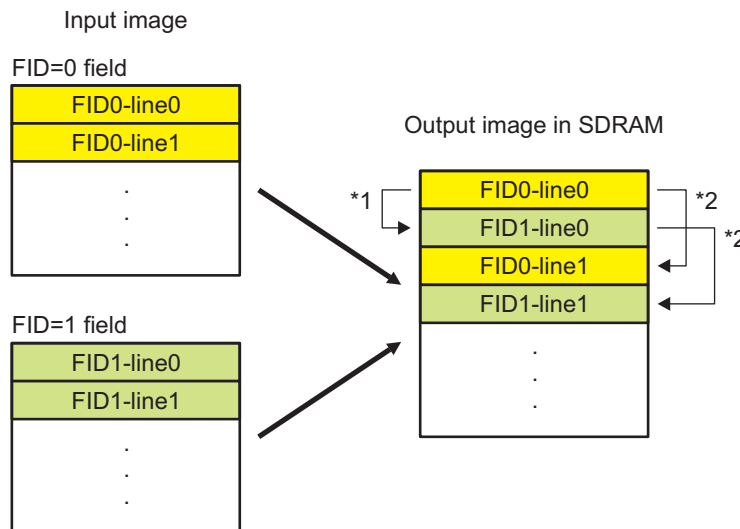
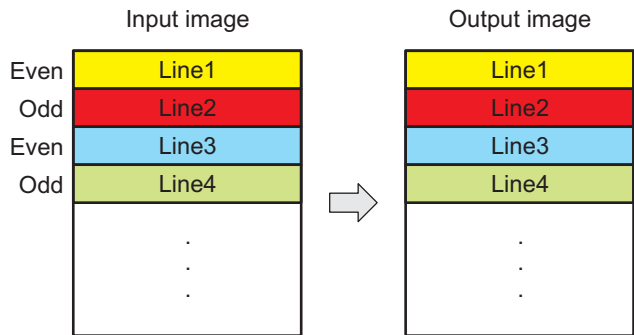
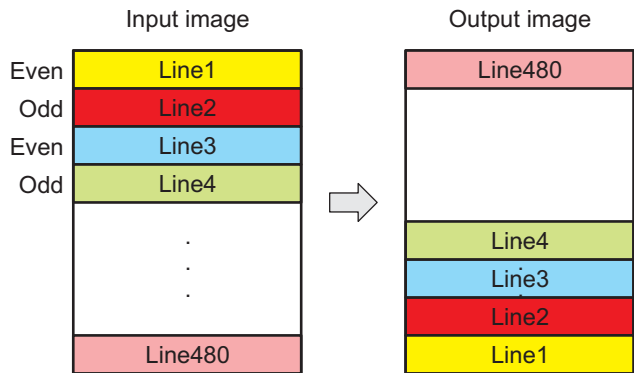


Figure 33. Example Formats of Input and Output Image



SDOFST[14] = 0 ;Non inverse  
 SDOFST[13:12] = 00B ;+1 line when field ID is 1  
 SDOFST[11:9] = 001B ;+2 line, even line and field ID = 0  
 SDOFST[8:6] = 001B ;+2 line, odd line and field ID = 0  
 SDOFST[5:3] = 001B ;+2 line, even line and field ID = 1  
 SDOFST[2:0] = 001B ;+2 line, odd line and field ID = 1

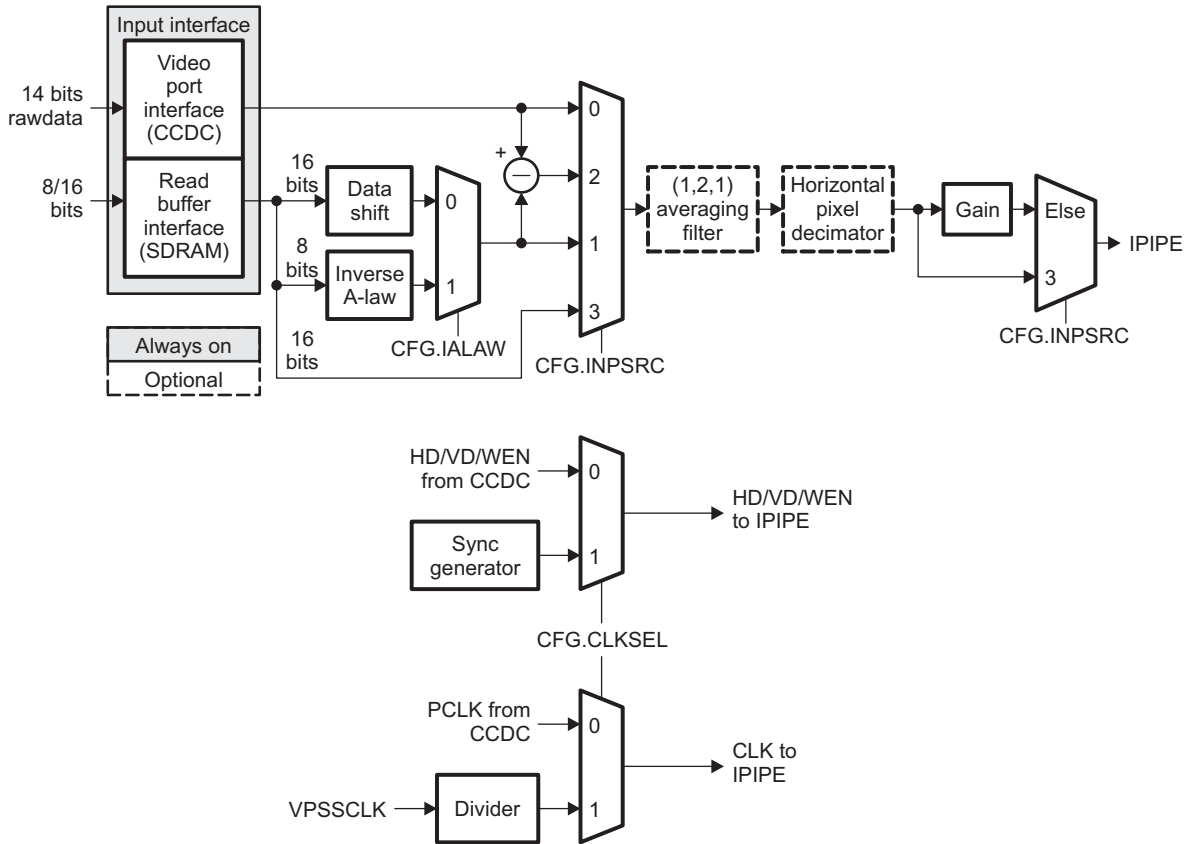


SDOFST[14] = 1 ;Non inverse  
 SDOFST[13:12] = 000B ;-1 line when field ID is 1  
 SDOFST[11:9] = 101B ;-2 line, even line and field ID = 0  
 SDOFST[8:6] = 101B ;-2 line, odd line and field ID = 0  
 SDOFST[5:3] = 101B ;-2 line, even line and field ID = 1  
 SDOFST[2:0] = 101B ;-2 line, odd line and field ID = 1

## 4.2 Image Pipe Interface (IPIPEIF)

The IPIPE Interface (IPIPEIF) is the data and sync signals input interface module for the IPIPE. The rest of this section describes, in detail, the functionality of each sub-block in the IPIPEIF as shown in Figure 34.

Figure 34. Image Pipe Interface Processing Flow



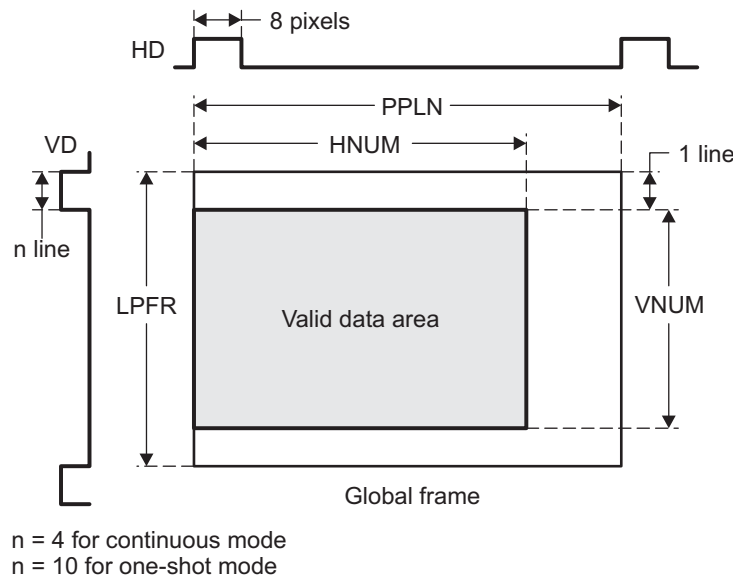


### 4.2.1 Input Interface and Preprocessing

The Image Pipe I/F can receive data from both the video port interface via the CCD/CMOS Controller module and from the read buffer interface via SDRAM/DDRAM. The input sources and data type (RAW or YCbCr) are configured in the CFG.INPSRC register field. The four available options for input source/type combinations and any preprocessing operations are discussed further in the following sub-sections.

When input from SDRAM/DDRAM is required, the SDRAM/DDRAM address (ADDRU, ADDRL) and line offset (ADOFs) registers must be programmed in units of 32 bytes. Additionally, the HNUM and VNUM registers define the number of pixels per line and lines per frame to read from the SDRAM as shown in Figure 35. For all SDRAM input modes except Darkframe subtract, the LPFR and PPLN registers define the interval of VD and HD, respectively.

**Figure 35. Global Frame Definition in SDRAM Input Modes (except Darkframe)**



#### 4.2.1.1 CCDC RAW Input Mode (CFG.INPSRC = 0)

The input data from the video port interface of the CCDC is 14 bits RAW data.

#### 4.2.1.2 SDRAM RAW Input Mode (CFG.INPSRC = 1h)

When the input source is RAW data from the SDRAM read buffer interface, the data can either be read as 1 pixel for every 8 bits, or 16 bits in memory (CFG.PACK8IN). The 8-bit RAW data can either be linear or non-linear.

In order to save DDR2/mDDR controller capacity and bandwidth, the CCD Controller includes an option to apply 10-bit to 8-bit A-Law compression and to pack the sensor data to 1 byte per pixel. In order to process this data properly, the Inverse A-law block is provided to decompress the 8-bit non-linear data back to 10-bit linear data if enabled (CFG.IALAW). This 10-bit data is padded with four low zeros to form a 14-bit bus.

If the Inverse A-law is not enabled, then the data read from SDRAM can be shifted by the CFG.DATASFT register field to select which 14 bits to use.

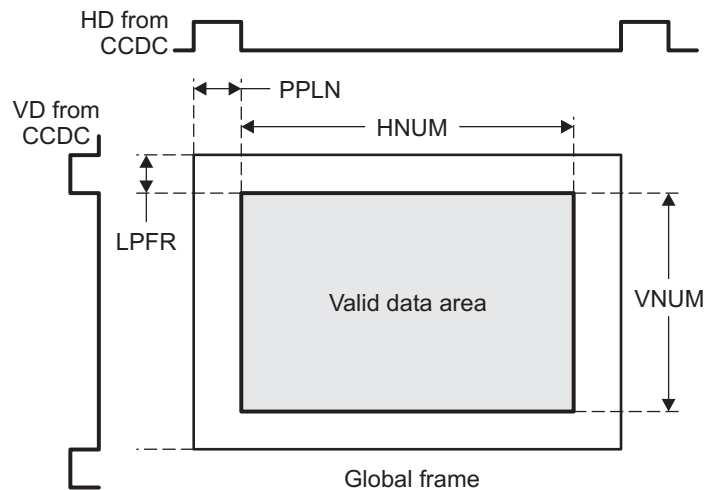
#### 4.2.1.3 CCDC RAW Input With Dark Frame Subtract From SDRAM Mode (CFG.INPSRC = 2h)

The dark frame subtract function is used to remove pattern baseline noise in the sensor. Typically, the CCDC will previously write a dark frame (frame captured when the shutter is closed) to SDRAM using 8 bits of linear data packed into 2 pixels per 16 bits. Eight bits should be enough even if the resolution of the RAW data is 14 bits, since a dark frame should not have values greater than 255 unless it is a fault pixel.

In this mode, everything from the previous two sections also applies since RAW data is used from both the CCDC and SDRAM. Data should be read from SDRAM with CFG.ALAW set to 0 and CFG.PACK8IN set to 1. Each pixel read from SDRAM will be subtracted from each pixel sent from the CCDC.

The output of the dark frame Subtract operation is 14-bits wide (U14Q0). Note that there must be adequate SDRAM/DDRAM bandwidth if this feature is enabled. If the data fetched from memory arrives late, then there is no way of knowing. Also note that in dark frame subtract mode, the PPLN and LPFR registers should be used to indicate the horizontal and vertical start position of the subtraction from the CCDC data as shown in Figure 36. The value of the LPFR must be greater than 0 since the first line from the CCDC can not be subtracted from.

**Figure 36. Global Frame Definition in Darkframe Subtract Mode**



#### 4.2.1.4 SDRAM YCbCr 4:2:2 Input Mode (CFG.INPSRC = 3h)

When the input source is YCbCr 4:2:2 data from the SDRAM read buffer interface, the data is expected to be stored as 16 bits in memory so there is no shifting or other pre-processing done.

### 4.2.2 Timing Generation

When the input source is from the video port interface of the CCDC (CFG.INPSRC = 0 or 2), HD/VD/WEN signals are taken from the CCDC. The CFG.CLKSEL should be set to 0 so that data is latched into the IPIPE using the PCLK from the CCDC.

When the input source is not from the CCDC (CFG.INPSRC = 1 or 3), the HD/VD signals are generated in the IPIPEIF based on the LPFR and PPLN registers (WEN is not generated). The CFG.CLKSEL can be set to either 0 (to continue to use the CCDC PCLK for reading SDRAM data) or 1 (so that the IPIPEIF generates the proper timing of PCLK). If CFG.CLKSEL is set to 1, then the CFG.CLKDIV register is then used to select a divide ratio of the VPSS functional clock (VPSSCLK) for the pixel clock frequency which is used to clock the data into the PCLK. The value of this register should be set based on the maximum PCLK that the resize ratios of the IPIPE resizers require (see equation in [Section 4.3.15](#)). Once this is satisfied, then further consideration may be given to the available DDR2/mDDR controller system bandwidth and the real time requirement of the IPIPE processing of the frame.

When CFG.INPSRC is not set to 0, then the IPIPE I/F SDRAM data reading and timing generation can be enabled (ENABLE.ENABLE) in either one-shot mode, or continuous mode (CFG.ONESHOT).

### 4.2.3 (1,2,1) Averaging Filter

The averaging filter can be optionally enabled by setting the CFG.AVGFLT register bit. It acts as an anti-aliasing low-pass filter for the horizontal pixel decimator. It typically is only needed when the pixel decimator is used (CFG.DECM = 1). It operates on every other pixel (same color) in a RAW bayer input or every Y component in YCbCr data in the following equation:

$$output = (input[l - 1] + 2 * input[l] + input[l + 1]) >> 2$$

### 4.2.4 Horizontal Pixel Decimator (Downsizer)

The image pipe input is limited to 1344 pixels per horizontal line due to line memory width restrictions in the various filtering blocks. In order to support sensors that output greater than 1344 pixels per line, a line width decimator can be enabled (CFG.DECM) to downsample the input lines to a width equal to or less than the 1344 pixel maximum. The resize ratio can be configured by programming the RSZ register to be within the range from 16 to 112 to give a resampling range from 1× to 1/7× (16/RSZ).

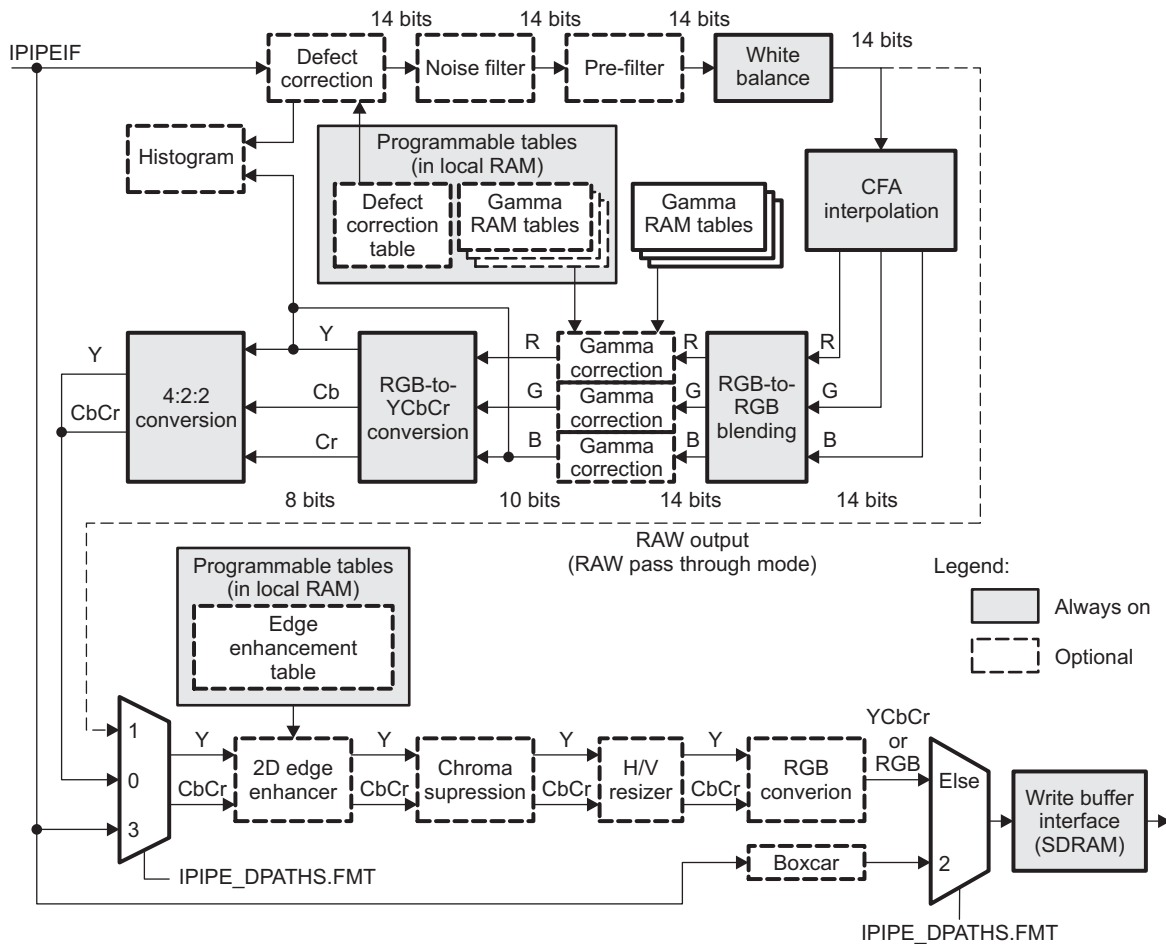
### 4.2.5 RAW Data Gain

A gain factor ranging from 0.00195(1/512) to 1.99805(1023/512) is multiplied to the RAW output of the IPIPEIF. The gain constant is set in the GAIN register using U10Q9 format.

### 4.3 Image Pipe (IPIPE)

The Image Pipe (IPIPE) is a programmable hardware image processing module that generates image data in YCbCr-4:2:2 format from RAW CCD/CMOS data. The IPIPE can also be configured to operate in a resize only mode, which allows YCbCr-4:2:2 to be resized without applying the processing of every other module in the IPIPE. The input and output data type (data path) can be configured by setting the IPIPE\_DPATHS.FMT register field. The output of the IPIPE is typically used for both video/image compression and display. The rest of this section describes, in detail, the functionality of each sub-block in the IPIPE as shown in Figure 37.

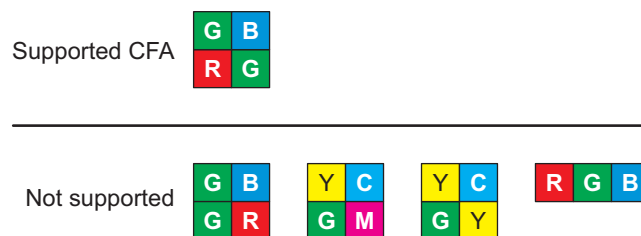
Figure 37. Image Pipe Processing Flow



#### 4.3.1 CFA Arrangements

Figure 38 shows the CFA arrangements that the IPIPE supports. Notice that although complementary CFA patterns are not supported directly by the IPIPE, the CCDC can perform a color space conversion from complimentary to bayer, which the IPIPE supports.

Figure 38. CFA Arrangements



### 4.3.2 Input Interface

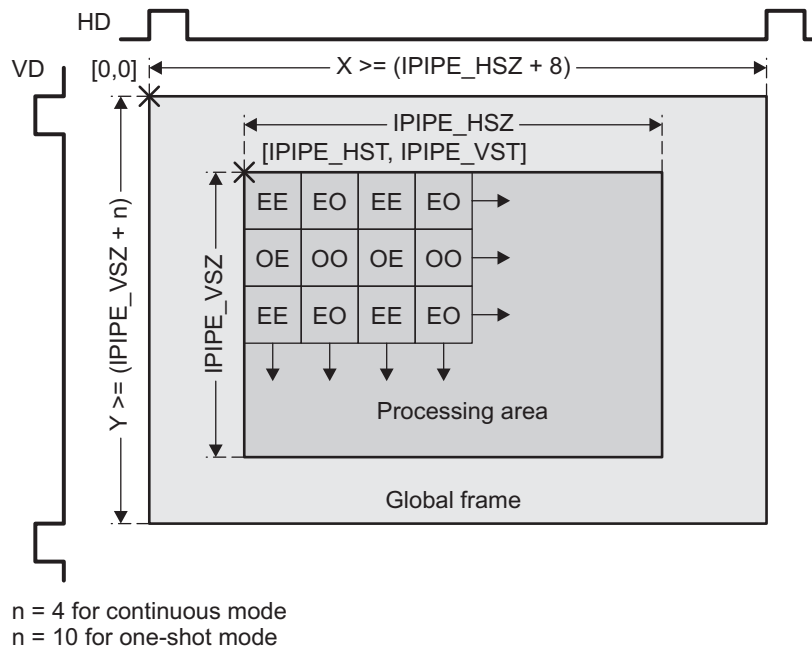
The IPIPE receives 14bit RAW image data or 16 bit YCbCr data via IPIPEIF. The IPIPE can work with up to 1344 pixels in each horizontal line, except in RAW pass through mode where no image processing is applied. If the image width is larger than 1344, the image must be scaled down at PIPEIF. Otherwise, the input image must be split into several blocks. If the input data is YCbCr, all RGB processing modules are skipped, and only edge enhancer, chroma suppression, and resizer are applied to the input data. In RAW pass through mode, images up to 4096 pixels per line may be processed. In RAW pass through mode, the input data is directly written out to SDRAM. The processing steps available for the different input modes are shown in [Table 22](#). The bolded rows are the functions which are required and can not be disabled.

**Table 22. Available Processing for Input Modes**

Functions	Input Modes (IPIPE_DPATHS.FMT)			
	0: RAW to YCbCr	1: RAW to RAW	2: RAW to Boxcar	3: YCbCr to YCbCr
Defect Correction	X	X		
Noise Filter	X	X		
Pre Filter	X	X		
White Balance	X	X		
CFA Interpolation	X			
RGB to RGB Blending	X			
Gamma Correction	X			
RGB to YCbCr Conversion	X			
4:2:2 Down-Sampling	X			
Edge Enhancement	X			X
Color Suppression	X			X
H/V Resize	X			X
RGB Conversion	X			X
Histogram	X	X		
Boxcar			X	

The input interface sub-module clips the processing area in the global frame by setting the start position (IPIPE\_HST, IPIPE\_VST) and size (IPIPE\_HSZ, IPIPE\_VSZ) horizontally and vertically as shown in Figure 39. Table 23 further describes the labels in the figure.

**Figure 39. Processing Area Within Global Frame**



**Table 23. Label Descriptions From Figure 39**

Label	Description
VD	The vertical synchronous signal from the IPIPEIF module. The IPIPE module judges this signal by the rising edge only.
HD	The horizontal synchronous signal from the IPIPEIF module. The IPIPE module judges this signal by rising edge only.
EE, EO, OE, OO	Color pattern as defined in the IPIPE_COLPAT register.
X	Number of the clock counts between HD and HD. The IPIPE module requires that X is larger than IPIPE_HSZ by at least 8 clocks.
Y	The number of the line counts between VD and VD. The IPIPE module requires that Y is larger than IPIPE_VSZ by at least 4 lines. When the frame is operated in one shot mode (IPIPE_MODE.ONESHOT = 1), there need be at least 10 lines after processing area, i.e. $Y \geq IPIPE\_VSZ + IPIPE\_VST + 10$ .

### 4.3.3 Defect Correction

The defect correction (or fault pixel correction) module fixes fault pixels in input data due to sensor defects known at camera manufacture time. This function can be optionally enabled by setting the DFC\_EN.EN register bit. The defect correction module supports up to 1024 defect points. The module uses a 1024 × 27-bit local memory to store the defect information table. The programmable table contains the information of horizontal position (12 bits), vertical position (12 bits), and correction method (3 bits) for each defect as shown in Figure 40. The information must be listed in raster scan order: "from left to right" and "from the top to the bottom". The first position in the defect information table (DFC\_ADR) and the number of defects which are actually used (DFC\_SIZ) may be specified through register values.

**Figure 40. Defect Information Packet**

Correction method	Vertical position	Horizontal position
26..24	23..12	11..0

The correction methods are as follows. Each method is explained in the following section. The pixels in defect correction algorithm are numbered as in [Figure 41](#).

Bits 26-24	Correction method
0	Horizontal interpolation
1h	Copy from left
2h	Copy from right
3h	4-directional interpolation $((d2 + d4 + d5 + d7)/4)$
4h	Vertical interpolation after horizontal interpolation
5h	Vertical interpolation after copy from left
6h	Vertical interpolation after copy from right
7h	Copy from top (DFC_SEL = 0) or bottom (DFC_SEL = 1) after horizontal interpolation

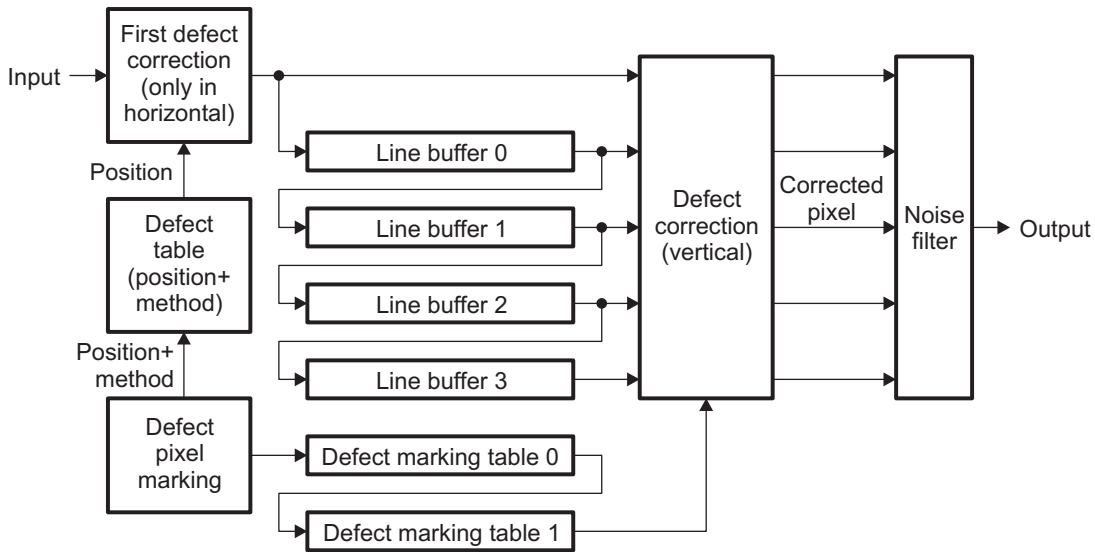
Method	Horizontal Processing	Vertical Processing
0	$(d4 + d5)/2$	None
1	d4	None
2	d5	None
3	$(d4 + d5)/2$	$((d4 + d5)/2 + (d2 + d7)/2)/2$
4	$((d4 + d5)/2)$	$(d2 + d7)/2$
5	d4	$(d2 + d7)/2$
6	d5	$(d2 + d7)/2$
7	$(d4 + d5)/2$	d2 or d7

**Figure 41. Numbering in Defect Correction Algorithm**

d1		d2		d3
d4		d0		d5
d5		d7		d8

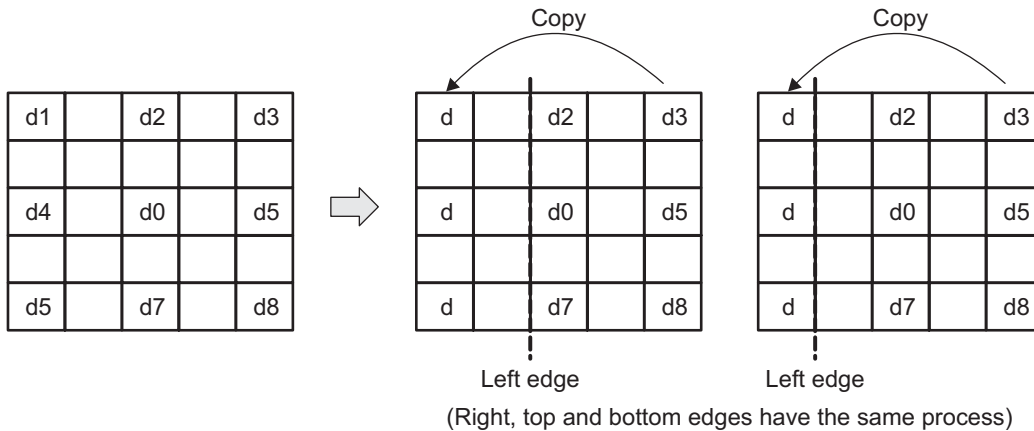
The defect correction process is divided into horizontal correction and vertical correction. For method 0, 1, and 2, only the horizontal correction is applied. For methods 3-7, horizontal correction is applied first, then vertical correction replaces the pixels in the center line at the noise filter. This process is described in [Figure 42](#).

Figure 42. Defect Correction Functional Model



The pixels at the edges are mirrored as shown in Figure 43 to avoid copying the defect center pixel.

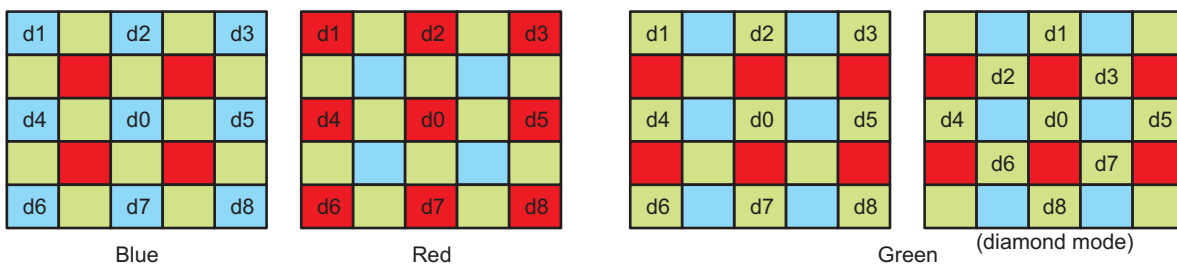
Figure 43. Mirroring in Defect Correction and Noise Filter



#### 4.3.4 Noise Filter

The two-dimensional noise filter reduces noise in raw input data and can be enabled by setting the D2F\_EN.EN bit. The 3x3 grid of same color pixels used for this filtering is shown in Figure 44. The pixel being filtered is "d0". "d0" ~ "d8" are same color pixels. For green, one of two numbering methods can be selected (D2F\_CFG.TYP), box or diamond.

Figure 44. Noise Filter Array





### 4.3.5 Pre Filter

The 2-D pre-filter can be enabled (`PRE_EN.EN`) to reduce the effect of line-crawling and is applied only to green pixels. One of the following two algorithms can be selected (`PRE_TYP`):

- Averaging filter with constant gain
- Adaptive gain control algorithm

### 4.3.6 White Balance

The white balance module executes a digital gain adjustment and a white balance adjustment to CCD raw data. Digital gain is for adjusting a total brightness of image, and white balance gains are for adjusting a ratio of each color in a CFA pattern.

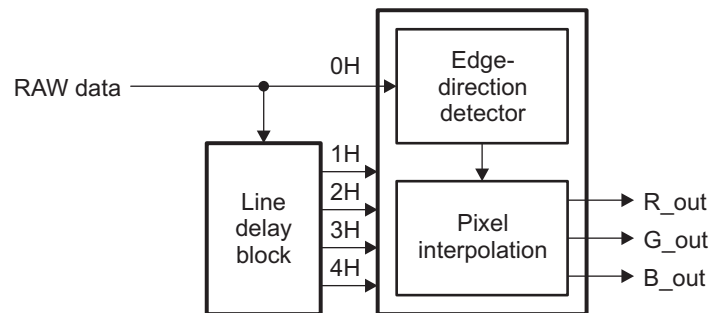
There are two multipliers for the two gain adjustments: a digital gain adjuster and a white balance adjuster. In the digital gain adjuster, the raw data is multiplied by a fixed value gain (`WB2_DGN`) regardless of the color. In the white balance gain adjuster, the raw data is multiplied by a selected gain corresponding to the color. The white balance gain can be selected from four 10-bit values (`WB2_WG_R`, `WB2_WG_GR`, `WB2_WG_GB`, & `WB2_WG_B`). Firmware can assign any combination of 4 pixels in the horizontal and vertical direction. The precision of each gain is as follows:

- TOTAL GAIN :  $x \ 0 - x \ 3.996$  (step =  $1/256$ )
- WB GAIN:  $x \ 0 - x \ 7.992$  (step =  $1/128$ )

### 4.3.7 CFA Interpolation

The IPIPE's CFA (color filter array) interpolation module generates RGB 4:4:4 data from a Bayer RGB pattern. The block diagram of the CFA (color filter array) interpolation module is shown in Figure 45. The color filter array consists of the line delay block, the edge-direction detector and the pixel interpolator. The edge-direction detector detects most probable edge direction of an object to which the target pixel belongs, and the pixel interpolator calculates the missing color according to its edge direction within 5x5 pixel window.

Figure 45. CFA Interpolation Functional Model



### 4.3.8 RGB2RGB Blending

The RGB2RGB blending module transforms the RGB data generated by the CFA interpolation module using a 3x3 square matrix transformation in combination with an added offset. This is programmable (`RGB_MUL_[R,G,B][R,G,B]`, & `RGB_OFT_[R,G,B]`) so that the color spectrum of the sensor can be adjusted to the human color spectrum. The RGB to RGB blending is calculated using the following formula. Each gain range is from -8 to +7.996 with step  $1/256 = 0.004$  (signed 12 bits). The offset takes -8192 ~ 8191 (signed 14 bits) value range.

$$\begin{pmatrix} R\_out \\ G\_out \\ B\_out \end{pmatrix} = \begin{pmatrix} gain\_RR & gain\_GR & gain\_BR \\ gain\_RG & gain\_GG & gain\_BG \\ gain\_RB & gain\_GB & gain\_BB \end{pmatrix} \begin{pmatrix} R\_in \\ G\_in \\ B\_in \end{pmatrix} + \begin{pmatrix} offset\_R \\ offset\_G \\ offset\_B \end{pmatrix}$$

### 4.3.9 Gamma Correction Module

The gamma correction module performs a gamma correction independently for each color in the RGB color space by using a piece-wise linear interpolation. The gamma correction function for each color can be separately bypassed (`GMM_CFG.BYPR`, `GMM_CFG.BYPG`, and `GMM_CFG.BYBP`). Either a fixed ROM table or programmable local RAM table can be used (`GMM_CFG.TBL`). Each RAM table has up to 512-entries, but can also be programmed to use only 256 or 128 (`GMM_CFG.SIZ`). Each entry accommodates a 10-bit gain and 10-bit slope. The ROM table has 1024 entries and outputs 8-bit values. As shown in Figure 46, this module exists independently for each color so that independent settings are possible.

Figure 46 shows a block diagram of the gamma correction module. It is composed of two tables and one selector. When the BYPASS bit is asserted, the input data is divided by 16. Figure 47 shows an example of a RAM gamma curve. The ROM gamma table is shown in Figure 48.

Figure 46. Gamma Correction Functional Model

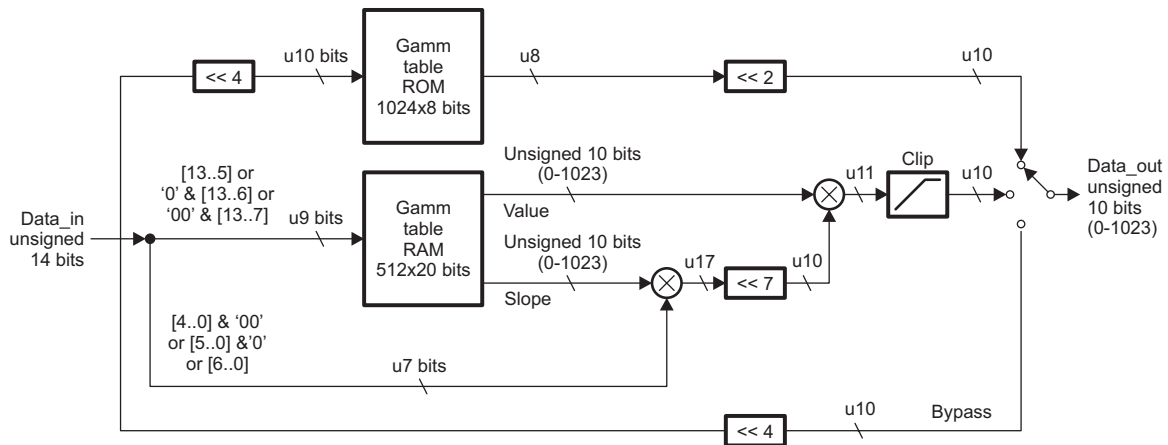
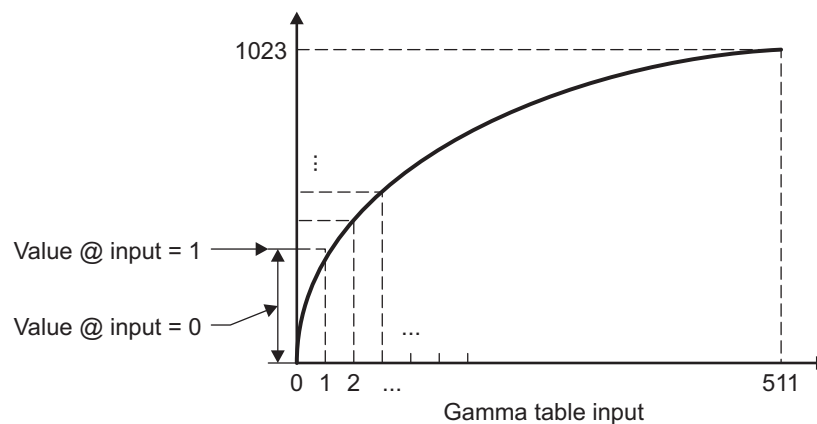
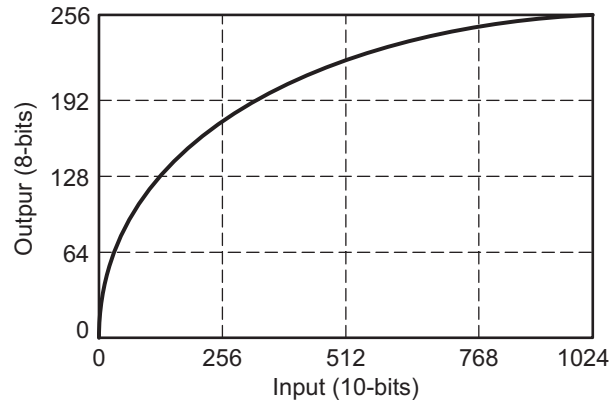


Figure 47. Example of Gamma Curve



**Figure 48. ROM Gamma Table**



#### 4.3.10 RGB2YCbCr Conversion Module

This module transforms the RGB data into YCbCr data format using a 3×3 square matrix transformation in combination with an added offset (YCC\_MUL\_[R,G,B][Y,CB,CR], and YCC\_OFT\_[Y,CB,CR]). Each gain range is from -2 to +1.984 with step 1/256 = 0.004. The offset range is -256 to 255. A block diagram of the RGB to YCbCr blending module is shown in [Figure 49](#). The output is calculated with the following equation:

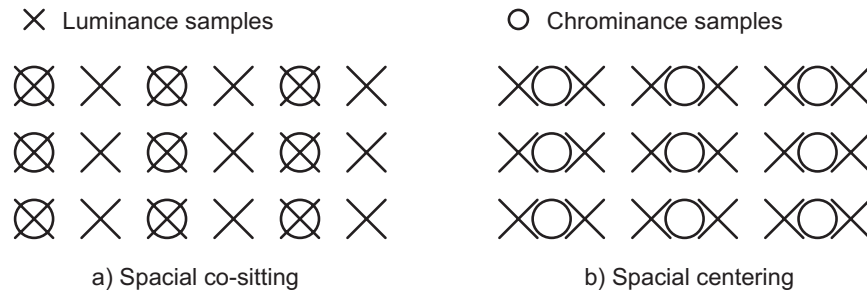
**Figure 49. RGB2YCbCr Conversion Functional Model**

$$\begin{bmatrix} Y\_out \\ Cb\_out \\ Cr\_out \end{bmatrix} = \begin{bmatrix} gain\_RY & gain\_GY & gain\_BY \\ gain\_RCb & gain\_GCb & gain\_BCb \\ gain\_RCr & gain\_GCr & gain\_BCr \end{bmatrix} \begin{bmatrix} R\_in \\ G\_in \\ B\_in \end{bmatrix} + \begin{bmatrix} offset\_Y \\ offset\_Cb \\ offset\_Cr \end{bmatrix}$$

#### 4.3.11 4:2:2 Conversion Module

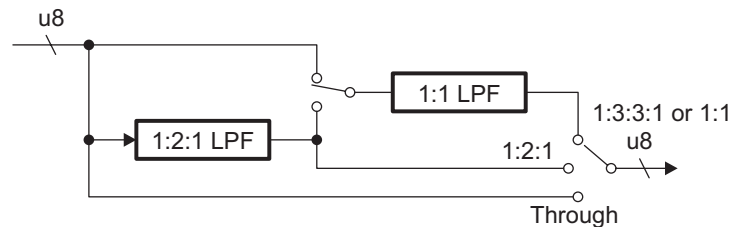
The 4:2:2 conversion module converts the image data to YCbCr-4:2:2 format by taking the average of every two Cb and Cr components. The Y and Cb/Cr sampling point of either spatial co-siting or spatial centering are selectable (YCC\_PHS.POS). Horizontal 3 taps and 4 or 2 taps filters are used for spatial co-siting and spatial centering, respectively. An anti-aliasing filter can also optionally be enabled in the YCC\_PHS.LPF register field.

**Figure 50. Chroma Sub-Sampling Position**



A block diagram of 4:2:2 conversion module is shown in [Figure 51](#).

**Figure 51. 4:2:2 Conversion Functional Model**



#### 4.3.12 2-D Edge Enhancer

The edge-enhancer module optionally operates on the luminance (Y data) component of images to improve the image quality (YEE\_EN.EN). Edges in input images are detected by a  $5 \times 5$  2D high-pass filter with programmable coefficients (YEE\_MUL\_[0,1,2][0,1,2]). The output of the filter can be optionally down shifted by the length of the high pass filter (YEE\_SHF.SHF). The sharpness is increased by the value from a non-linear programmable table in local RAM.

#### 4.3.13 Median NR

The Median-NR is optionally used to reduce the pseudo peak in edge intensities (YEE\_EMF.EN). Median-NR takes median values from four directions in the  $3 \times 3$  edge intensities arrays. Then it outputs the intensity that is closest to the center value.

#### 4.3.14 Chrominance Suppression

Occasionally, in very bright portions of an image, only one or two of the color channels may be saturated but the remaining channel(s) may not be. This may lead to a false color effect. One common example would be the appearance of a pink color where white should be. Chrominance suppression can be used to reduce this pseudo-coloring of images. The chrominance suppression operation can optionally be enabled or disabled using the FCS\_EN.EN parameter.

False color pixels can also be introduced on edges by the CFA interpolation function. The luminance value used in the chroma suppression calculation can optionally be configured to be the actual luminance value, or the high pass filtered version of the luminance value for identifying this edge information.

#### 4.3.15 Horizontal and Vertical Resize Module

The Resize module is capable of re-scaling images into various sizes ranging from x1/16 scale-down to x8 scale-up in both the horizontal and vertical directions. After resizing process, the processed data are transferred to the SDRAM. [Table 24](#) shows the format of YCbCr image data in SDRAM.

The scaling process in horizontal direction is carried out using interpolation with 4-tap filter. The interpolation method is either 4-tap cubic convolution, or 2-tap linear filter depending on the setting of the RSZ[n].RSZ\_H\_TYP register. For scale down, the horizontal resize process is also equipped with an adjustable 7-tap anti-alias filter. Vertical resizing is processed with 2-tap linear filter. The range of resizing ratio is determined by two parameters HRSZ (RSZ[n].RSZ\_H\_DIF) and VRSZ (RSZ[n].RSZ\_V\_DIF), which may be set independently. The resizing ratio of output image equals to 256/HRSZ for horizontal process and 256/VRSZ for vertical process. The upper and lower limits of HRSZ and VRSZ are 32 and 4096, which correspond to x8 scale-up and x1/16 scale-down respectively. The sizes of output images are limited to below 1344 pixels/line for RSZ[0] and 640 pixels/line for RSZ[1].

Scale-up performance of the module depends on the frequency ratio between the pixel clock and SDRAM clock. When the pixel and SDRAM clock are 20MHz and 90MHz respectively, the total scale-up capability is approximately  $(90 \text{ MHz}/20 \text{ MHz}) \times 2$  parallel-output = x9-scale-up, i.e. x6-scale-up for image-a and x3-scale-up for image-b. More precise measure of the performance limit is as following. The vertical resize ratio for image-a and image-b must satisfy:

$$(\text{number of clocks per horizontal line of IPIPE input}) \times \left( \frac{\text{VPSSCLK frequency}}{\text{pixel clock frequency}} \right) > ha \times ra + hb \times rb + \text{overhead}$$

where

$$ha = \frac{\text{horizontal size of image-a output} + \text{output start position of image-a}}{\min(1, \text{horizontal resize ratio of image-a})}$$

$$hb = \frac{\text{horizontal size of image-b output} + \text{output start position of image-b}}{\min(1, \text{horizontal resize ratio of image-b})}$$

$$ra = \text{ceil}(\left(\frac{\text{vertical resize ratio of image-a}}{2}\right))$$

$$rb = \text{ceil}(\left(\frac{\text{vertical resize ratio of image-b}}{2}\right))$$

$$\text{overhead} = 100 \times (ra + rb)$$

Here, min(a, b) is the smaller of a and b, and ceil(x) is the smallest integer number that is equal to or greater than x. The right side value should be well below the left side value.

Actual performance limit of resize output is also limited by the band-width of the attached SDRAM. Average output pixel per clock of each line must not exceed the band-width available to IPIPE module. For example, if the allowed band-width is 1 byte/clock, output pixel per clock in each line must be lower than 1 pixel per every two clocks with some margin for overhead. Therefore, allowed resize ratio in this case will be:

$$\text{image-a ratio} \leq x1, \text{ and image-b ratio} \leq x1$$

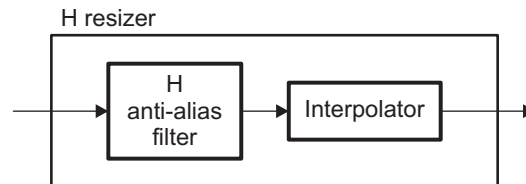
or

$$\text{image-a ratio} \leq x2, \text{ and no image-b}$$

**Table 24. YcbCr-422 Memory Format**

Byte Address	YCbCr Data
4n	Cb0
4n + 1	Y0
4n + 2	Cr0
4n + 3	Y1

Figure 52 shows a block diagram of the horizontal resize block which has anti-alias filter.

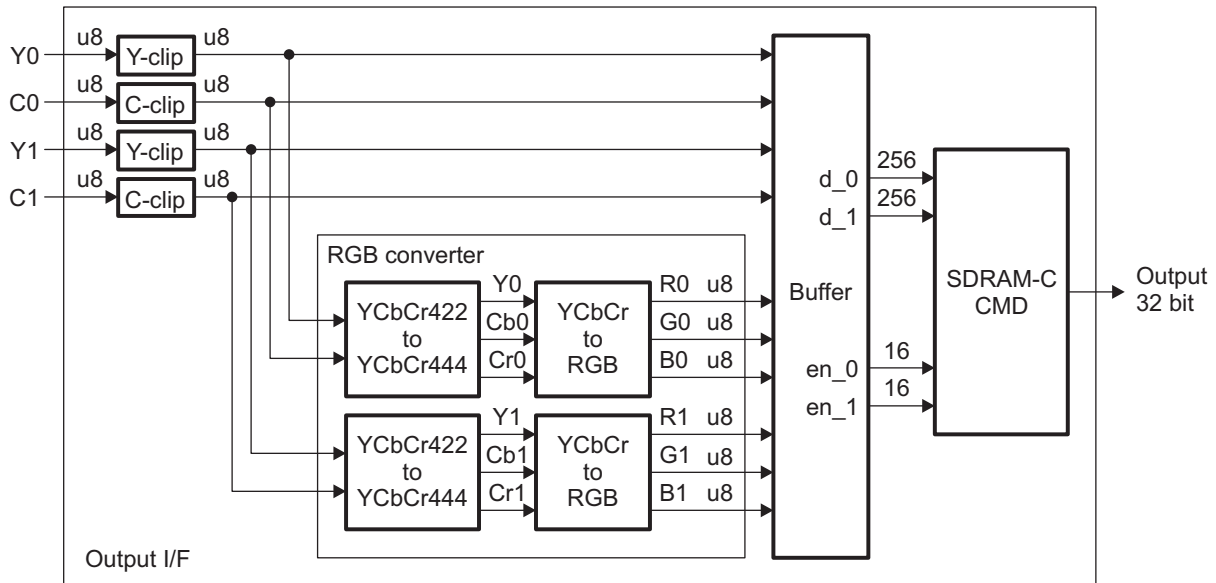
**Figure 52. Horizontal Resize Functional Model**


Vertical resize module supports two operation modes, input line number confined mode and continuous mode, for vertically split blocks (frame division mode). When input line number confined mode is selected ( $RSZ\_SEQ.TMM = 1$ ), the vertical resize module continues processing until the defined input lines are all processed. In this mode, the last state of the vertical interpolation operation is outputted to the  $RSZ[n].RSZ\_V\_PHS\_O$  register. This value may be used in the following resizing operation of the next vertical block as an initial phase input. (There needs be an overlap of one line; the last line of the previous block must be duplicated to make the first line of the next block.) Continuous mode is a mode which preserves the last state of the previous operation, and continues resizing as if the first processed line of the current frame directly follows the last line of the previous operation. With vertically split blocks, this mode may be used for processing of the second and latter blocks. Continuous mode works only in combination with input line number confined mode.

### 4.3.16 Output Interface

The block diagram of the output interface module is shown in Figure 53. Y-Clip and C-Clip modules limit the range of image data to [ymin to ymax] or [cmin to cmax]. The min and max values are specified in the YCC\_Y\_MAX, YCC\_Y\_MIN, YCC\_C\_MAX, and YCC\_C\_MIN registers.

Figure 53. Output Interface Functional Model



### 4.3.17 RGB Converter

The IPIPE optionally supports output of RGB data to SDRAM (RSZ[n].RGB\_EN.EN). The YCbCr 4:2:2 data from the resizer module is first converted to YCbCr 4:4:4 data by linear interpolation. Since the pixels at the left and right edges are mirrored for the interpolation, two pixels at each edge are affected. To remove this effect, two pixels at the start of each line (RSZ[n].RGB\_TYP.MSK0) and end of each line (RSZ[n].RGB\_TYP.MSK1) may be removed from the output. In this case, the horizontal size of the output image is 2 or 4 pixels smaller than what is specified in resizer output width register.

The YCbCr 4:4:4 data is converted to RGB using the following equation.

$$\begin{pmatrix} R \\ G \\ B \end{pmatrix} = \begin{pmatrix} 1 & 0 & 1.402 \\ 1 & -0.34414 & -0.71414 \\ 1 & 1.772 & 0 \end{pmatrix} \cdot \begin{pmatrix} Y \\ Cb - 128 \\ Cr - 128 \end{pmatrix}$$

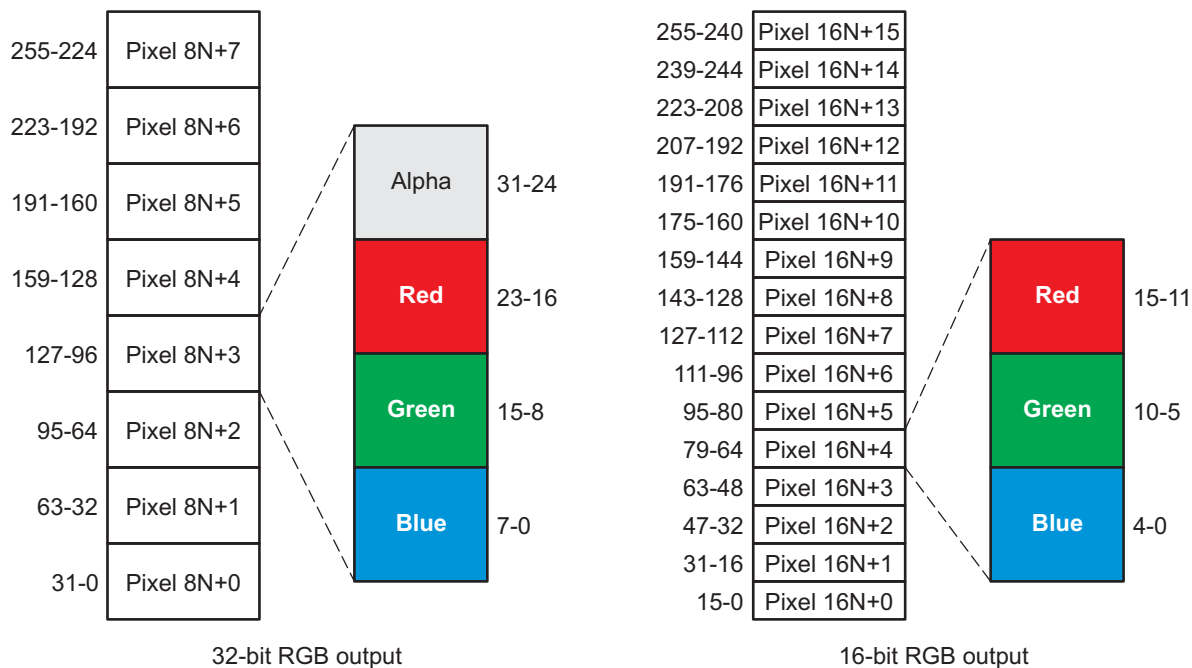
This equation is realized in actual circuit using the following equations.

$$\begin{aligned} R &= (512 \cdot Y/128 + 718 \cdot Cb'/128)/4 \\ G &= (512 \cdot Y/128 - 176 \cdot Cr'/128 - 366 \cdot Cb'/128)/4 \\ B &= (512 \cdot Y/128 + 907 \cdot Cr'/128)/4 \\ Cb' &= Cb - 128 \\ Cr' &= Cr - 128 \end{aligned}$$

The output image data is packed in each SDRAM access burst (256 bit) as shown in [Figure 54](#). There are two packing modes: 32-bit mode and 16-bit mode (RSZ[n].RGB\_TYP.TYP). In 32-bit mode, RGB data (8-bit each) and the alpha value (8-bit blending factor) are written to SDRAM. The alpha value is set in the RSZ[n].RGB\_BLD register. In 16-bit mode, R (5-bit), G (6-bit), and B (5-bit) are written.

Enabling RGB conversion and 32-bit/16-bit selection can be independently configured for both resizers.

**Figure 54. RGB Data Format**





### 4.3.18 SDRAM Writing Modes

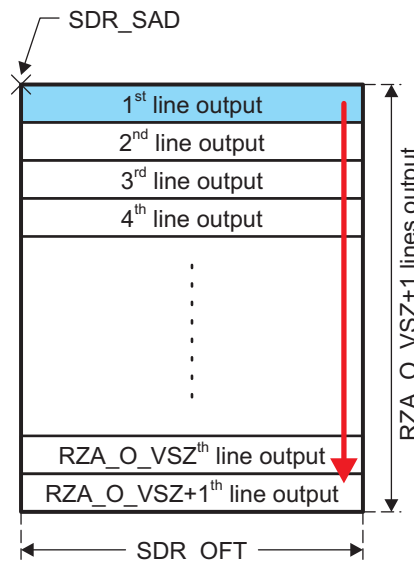
Table 25 describes the registers used for writing the output of the resizers to SDRAM.

**Table 25. SDRAM Write Registers**

Label	Description
RSZ[n].RSZ_SDR_BAD_H RSZ[n].RSZ_SDR_BAD_L	SDRAM base address of the output buffer in SDRAM
RSZ[n].RSZ_SDR_SAD_H RSZ[n].RSZ_SDR_SAD_L	SDRAM starting address of the output buffer in SDRAM for the first frame
RSZ[n].RSZ_SDR_OFT	SDRAM starting address of the output buffer in SDRAM for the first frame
RSZ[n].RSZ_SDR_PTR_S	Start line of SDRAM pointer
RSZ[n].RSZ_SDR_PTR_E	The maximum number of lines to be stored in SDRAM
RSZ[n].RSZ_SDR_PTR_O	Position of last line within the output buffer in previous resize process

For the simple case where there is one linear output buffer, only the RSZ[n].RSZ\_SDR\_SAD\_H/L and RSZ[n].RSZ\_SDR\_OFT registers are used along with the RSZ[n].RSZ\_O\_VSZ register as shown in Figure 55.

**Figure 55. Linear Buffer**



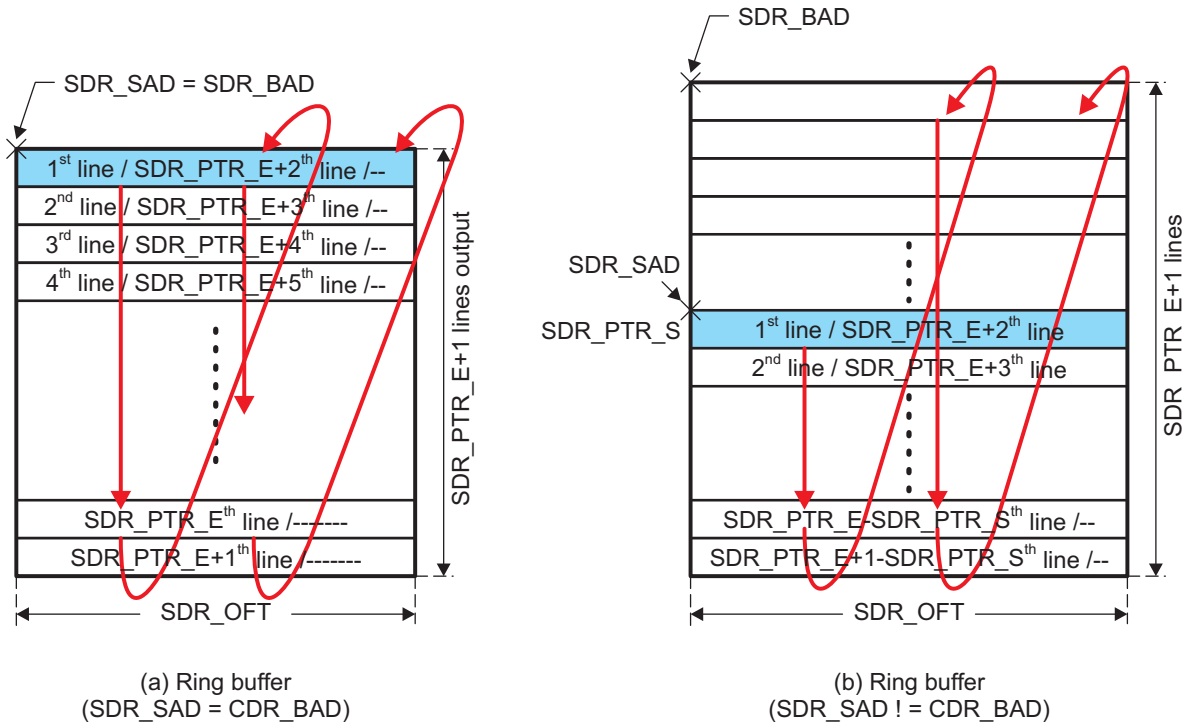
The other registers mentioned in Table 25 are used for implementing a ring buffer (or circular buffer) in SDRAM.

#### 4.3.18.1 Ring Buffer

The resizer can output data to a small size buffer by using a ring buffer as shown in Figure 56.

The first address of output buffer is set in RSZ[n].RSZ\_SDR\_SAD\_H/L register. The first address in the allowed memory space is set in RSZ[n].RSZ\_SDR\_BAD\_H/L register. The ring buffer size is set in the RSZ[n].RSZ\_SDR\_PTR\_E register. The first output line is set in RSZ[n].RSZ\_SDR\_PTR\_S register.

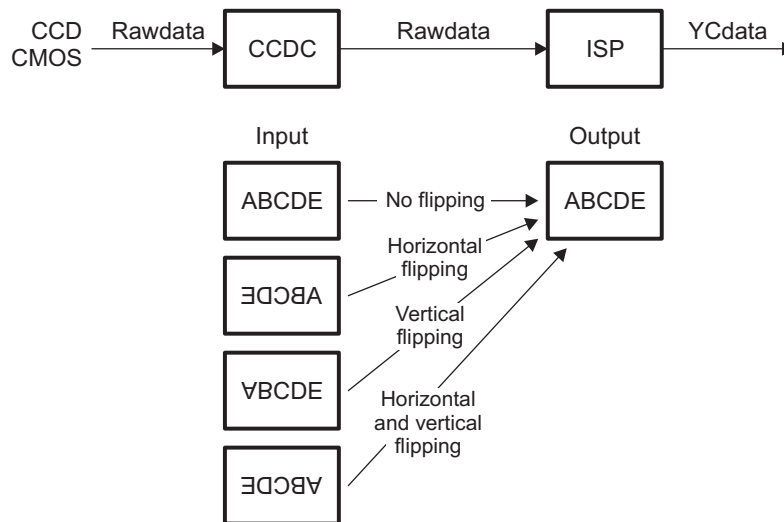
Figure 56. Ring Buffer



4.3.18.2 Horizontal and Vertical Image Flipping

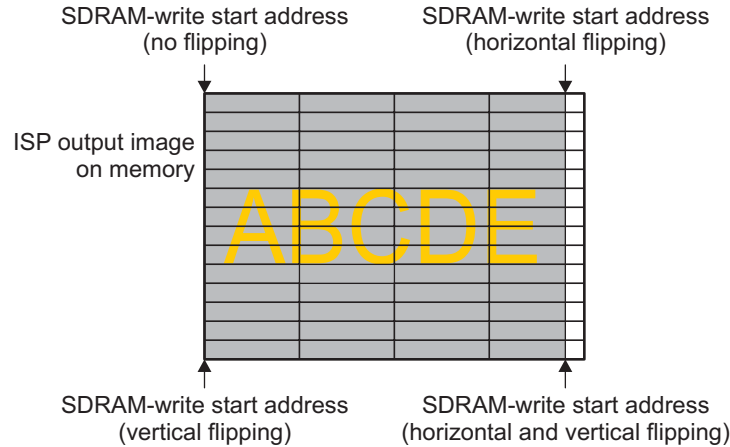
Flipping image function is implemented to support flipped input raw data. *Horizontal*, *vertical* and *horizontal & vertical* flipping modes are implemented as shown below (RSZ\_SEQ.HRV enables horizontal flip, and RSZ\_SEQ.VRV enables vertical flip).

Figure 57. Data Flipping Mode



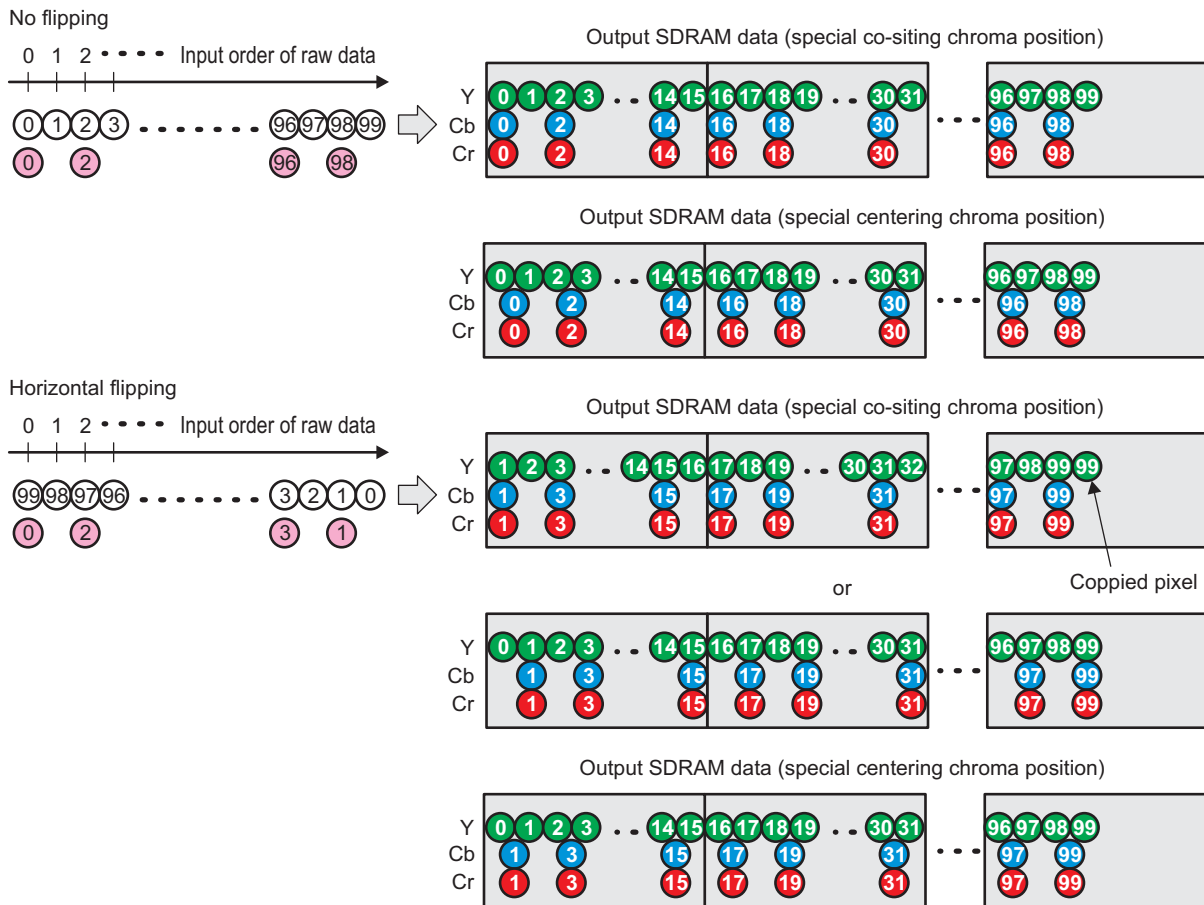
SDRAM write-start-address is needed to be set at the register by ARM. The address at each flipping mode is illustrated in Figure 58.

**Figure 58. Write Start Address at Each Flipping Mode**



In the non on-the-fly operation mode, CCDC flips the data and write raw data in the SDRAM. IPIPE does not flip data in this mode. Therefore horizontal flipping mode does not support the frame division mode - H/V. Figure 59 illustrates output data format to SDRAM at no flipping and horizontal flipping modes.

**Figure 59. Output Data Format to SDRAM**

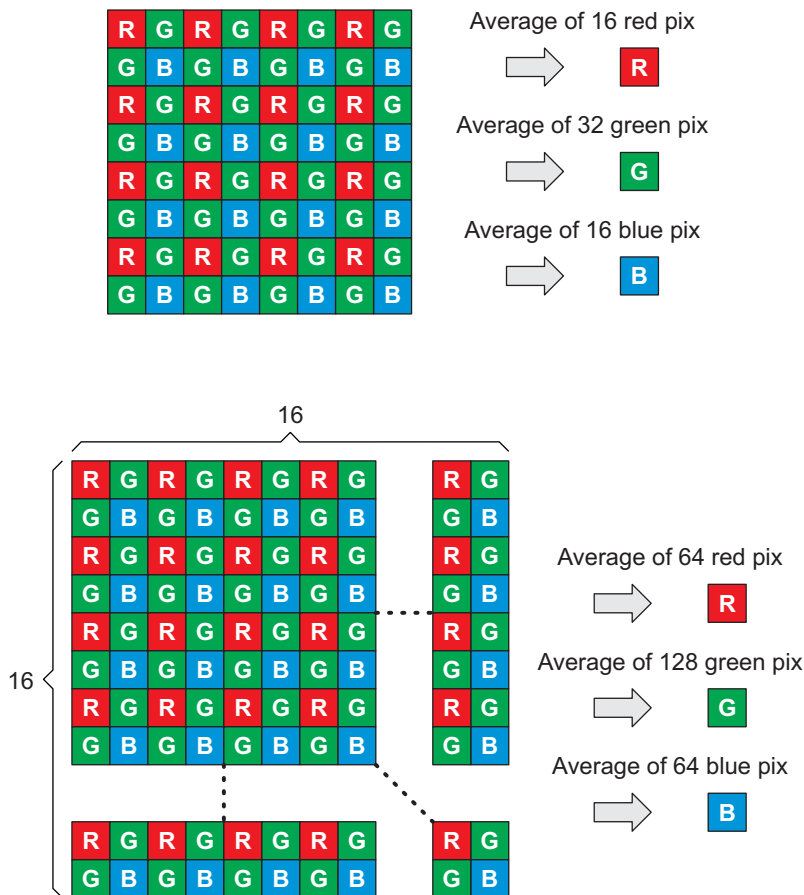


**4.3.19 Boxcar**

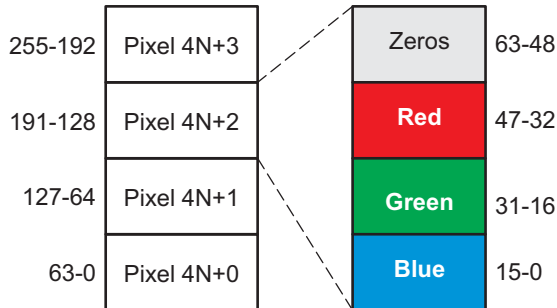
Boxcar module generates a boxcar by taking mosaic CCD data and averaging the red green and blue pixels in an 8x8 or 16x16 (BOX\_TYP) block to produce one red, green and blue output as shown in Figure 60 and in Section 4.3.20.

The result from this operation is a full color image with (1/64) or (1/256) area of the original image. The maximum input horizontal width is 4096 pixels wide when (16x16) block is used. If (8x8) is used, it is 2048. Also, the image size (width and height) must be multiple of 16 for (16x16) block, and multiple of 8 for (8x8) block. Boxcar operation works on up to 14 bit Bayer data and output 16-bit data. The output data are 48-bit RGB data for each 8x8 or 16x16 block. The 48 bit data is aligned in 64 bit format in SDRAM as shown in Boxcar Data Packing in SDRAM. The first address of SDRAM access is specified by RSZ[0].RSZ\_SDR\_SAD\_H and RSZ[0].RSZ\_SDR\_SAD\_L. The output data are written to SDRAM continuously line by line; there is no address offsets between lines.

**Figure 60. Boxcar Operation (8 x 8 block)**



**Figure 61. Boxcar Data Packing in SDRAM**



**4.3.20.1 Averaging**

First, the boxcar separately sums each color for a given block of pixels. For example, in the 8x8 case, all 16 red pixels per block are added together; same with blue. In the case of green, all of the green pixels are added together, and then divided by 2 since there are twice as many green pixels per block as there are red or blue. Then, the sum for each color in each block is right shifted by the value provided in the BOX\_SHF register to calculate the average to 16-bit dynamic range. The following equation can be used to calculate the required shift value:

$$\text{BOX\_SHF} = (\text{input bit resolution}) + \log_2(\text{summed pixels per color}) - (\text{output bit resolution})$$

8 x 8 mode:

$$\log_2(16) = 4$$

16 x 16 mode:  $\log_2(64) = 6$

For example, in the 16x16 mode, where in the input is 14 bits and the output is 16 bits:

$$\text{BOX\_SHF} = 14 + 6 - 16 = 4$$

The recommended shift values to get 16-bit output pixel resolution are shown in Table 25. The shaded row indicates the input bit width when the input is already aligned to the upper bits of the 14-bit data bus. The other two rows indicate the recommended shift values when the RAW input to the IPIPE is not aligned to the upper bits of the 14-bit bus.

**Table 26. Recommended SHIFT Values to Get 16-Bit Output Resolution**

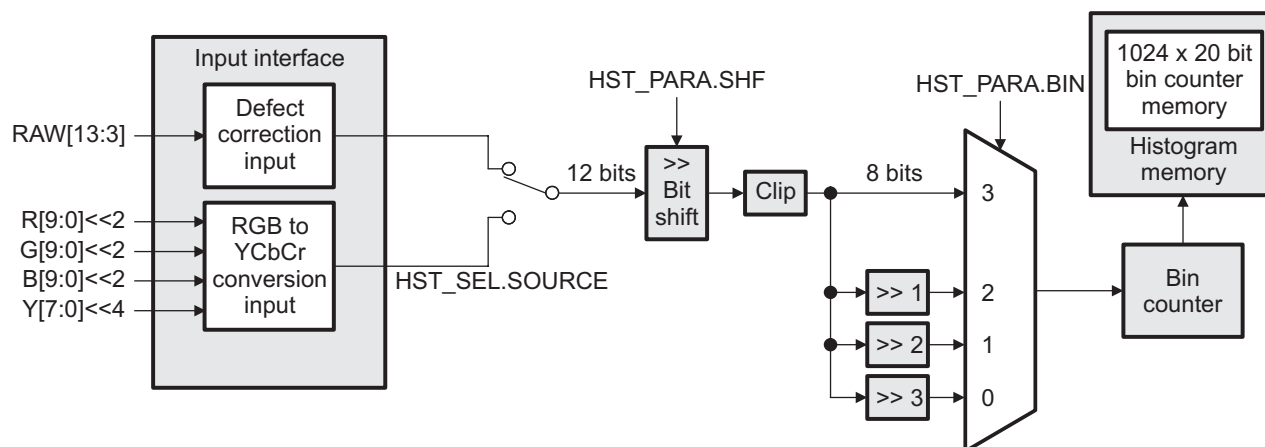
RAW IPIPE Input Resolution	8 x 8 Mode	16 x 16 Mode
12-bit RAW	0	2
13-bit RAW	1	3
14-bit RAW	2	4

Boxcar module runs only in stand-alone mode, i.e. no parallel IPIPE operation is allowed. Boxcar module shares memories with histogram module.

### 4.3.21 Histogram

The histogram accepts RAW image/video data from the defect correction function of the IPIPE, or color interpolated RGBY from the RGB to YCbCr conversion function of the IPIPE. It performs a color-separate gain on each pixel (white/channel balance), and bins them according to the amplitude, color, and region which are all specified via its register settings. It can support one, two, three, or four colors, and up to four regions simultaneously. Figure 62 shows the processing flow of the histogram module.

**Figure 62. Histogram Processing Flow**



#### 4.3.21.1 Features List

The histogram module counts number of pixels having a value in a region. Features of the histogram function are as follows:

- The histogram function normalizes input pixels to 12 bit resolution
- The data to be summed will be taken either from horizontal defect correction or from Gamma correction + RGB2YCbCr module.
- When sampled from defect correction, the R, G, B, Y data are taken from the output of line buffer, which is after horizontal defect correction and before vertical correction. The upper 12 bits of the 14 bit data (raw\_input[13:2]) are input to Histogram module.
- When sampled from Gamma correction + RGB2YCbCr module, R, G, B are sampled at the output of gamma correction, and Y is sampled at the output of RGB2YCbCr module. The 10-bit RGB and 8 bit Y are up-shifted to occupy the MSB of the 12 bit Histogram input.
- The colors to be summed are R/G/B/Y. If the data are taken from horizontal defect correction, Y is derived in the following method.  

$$Y = (R + Gr + Gb + B)/4$$
- For G histogram, either Gb or Gr is used
- If the data are taken from Gamma correction + RGB2YCbCr module, R is sampled at even pixels on even lines, G is sampled at odd pixels on even lines, B is sampled at even pixels on odd lines, and Y is sampled at odd pixels on odd lines.
- 1024 x 20-bit memory is used
- *the number of regions x the number of bins* <= 256
- The number of regions (areas): 1, 2, 3, or 4
- Each region can be turned on/off counting
- The regions have priority orders
- Each region has its own start coordinate X/Y (12-bit) and horizontal/vertical sizes (12-bit)
- When regions are overlapped, value in the overlapped region is only accumulated in the region with the highest priority.
- The number of colors to be counted: 1, 2, 3, or 4

- Each color in all regions can be turned off counting
- Value of each pixel is down-shifted before counting
- Down-shift bit number: 0 ~ 11 bits
- When value of a bin reaches to  $(2^{20} - 1)$ , the value is saturated until the memory is cleared.
- Number of bins: 32, 64, 128, or 256

#### 4.3.21.2 *Input Interface*

The histogram function can be configured to receive RAW image/video data from the defect correction module or YCbCr 4:4:4 image/video data from the RGB2YCBCR module (HST\_SEL.SOURCE).

#### 4.3.21.3 *Histogram Binning*

The histogram bins the input data by amplitude, color, and region. Each bin is a counter, counting the number of pixels of a color in the range associated with the bin. The number of bins can be programmed to 32, 64, 128, or 256 bins in the HST\_PARA.BIN field. However, due to the limited histogram memory size (1024 words), the number of bins (times four colors) limits the number of regions that can be active. The following equation must hold true:

$$\text{the number of regions} \times \text{the number of bins} \leq 256$$

Table 27 lists the possibilities based on this equation.

**Table 27. Regions and Bins for Histogram**

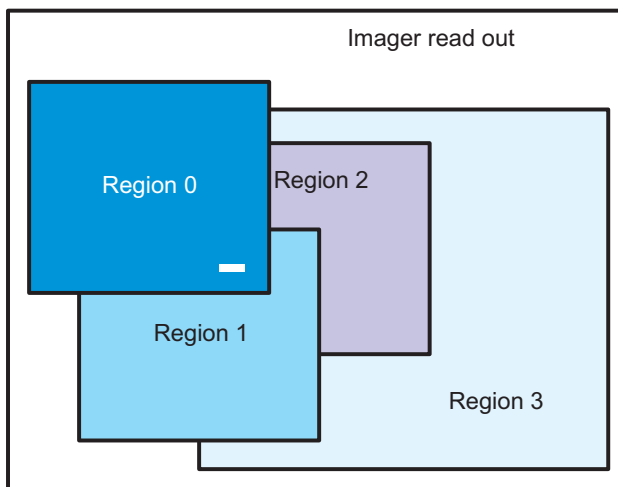
Number of Bins	Number of Regions Allowed
256	1
128	2
64	4
32	4

As indicated by Table 27, up to four overlapping regions can be designated within the frame and each of them can be separately enabled/disabled by configuring the HST\_PARA.RGNn fields. Each region is defined by the horizontal starting pixel (HST\_RGN[n].HST\_HST) and width (HST\_RGN[n].HST\_HSZ), and vertical starting line (HST\_RGN[n].HST\_VST) and height (HST\_RGN[n].HST\_VSZ) (where n is the region number 0..3).

### 4.3.21.3.1 Region Priority

Up to four regions can be active at any time but a pixel is only binned into one region. The priority is Region 0 > Region 1 > Region 2 > Region 3. For example, the white pixel in [Figure 63](#) will be binned only for *Region 0*, although it is present in all the four regions.

**Figure 63. Region Priority**



### 4.3.21.3.2 Bin Clipping and Right Shifting

As shown in [Figure 62](#), the input pixels to the Histogram are normalized to 12-bit values. In between the input and the binning function is a right-shift function. In order to properly distribute the dynamic range of the pixel values across all the bins, the bit-width of each pixel after right-shifting by HST\_PARA.SHF should always be 8-bits. Within these 8 bits, the histogram binning function automatically shifts as necessary based on the selected bin size. Since the input to the shift function is normalized to 12 bits, then the HST\_PARA.SHF value should always be set to 4 to avoid bin clipping and under-utilization of the chosen number of bins. If the shift value is too low, then the most significant bits will be clipped, and the highest bin will be incremented for a disproportionate number of pixel values. If the shift value is too high, then the full dynamic range of the pixel is not properly utilized, and the histogram will bin all the values to only the lower bin numbers, while the high bin numbers will never be incremented.

**EXCEPTION:** If the input is selected from the defect correction function, and if the dynamic range of the RAW data input to the IPIPE is less than 14 bits, then the shift value should not be set to 4. In this case, you will need to shift less to align the most significant bit with bit 7 on the output of the shift function. This is not considered for the RGB to YCbCr input since the data should have been fully shifted up to 14 bits before the CFA interpolation function.

The recommended shift values are shown in [Table 28](#). The shaded row indicates the input bit width when the input is from the RGB2YCbCr module and typical input from the defect correction module. The other 2 rows indicate the recommended shift values when the RAW input to the IPIPE is not aligned to the upper bits of the 14 bit bus.

**Table 28. Recommended SHIFT Values**

RAW IPIPE Input Resolution	Shift Value
12-bit RAW	2
13-bit RAW	3
14-bit RAW RGB to YCbCr Input	4



#### 4.3.21.3.3 Bin Saturation

The histogram bin counter memory is 20 bits wide. If incrementing a histogram bin would cause the value to become greater than what this memory word could hold, the value is saturated to the maximum value, which is  $2^{20} - 1$ .

#### 4.4 Statistics Collection - Hardware 3A (H3A)

The H3A module is designed to support the control loops for auto focus, auto white balance and auto exposure by collecting metrics about the imaging/video data. The metrics are to adjust the various parameters for processing the imaging/video data. There are two main blocks in the H3A module:

- Auto Focus Engine (AF) and
- Auto Exposure and Auto White Balance Engine (AE/AWB)

The AF engine extracts and filters the red, green, and blue data from the input image/video data and provides either the accumulation or peaks of the data in a specified region. The specified region is a two-dimensional block of data and is referred to as a *Paxel* for the case of AF.

The AE/AWB Engine accumulates the values and checks for saturated values in a sub sampling of the video data. In the case of the AE/AWB, the two-dimensional block of data is referred to as a *window*. Thus, other than referring to them by different names, a *Paxel* and a *window* are essentially the same thing. However, the number, dimensions, and starting position of the AF *Paxels* and the AE/AWB *windows* are separately programmable.

#### 4.5 VPFE Arbitration and Data Transfer Control (VPSSBL)

The buffer logic (VPSSBL) manages the flow of data between the VPSS modules and the DDR2/mDDR controller. In order to efficiently utilize the external DDR2/mDDR controller bandwidth, the buffer logic/memory interfaces with the DMA system via a high bandwidth bus (64-bit wide) at the DMA clock frequency (PLL1/4). The buffer logic/memory also interfaces with all the VPFE and VPBE modules via a 32-bit wide bus at the VPSS functional clock frequency (VPSSCLK).

Due to the real time demands of image processing at high speeds and image resolutions, the VPSS demands the highest bandwidth requirements in the system. The VPSS buffer logic optimizes data transactions with the DDR2/mDDR controller by buffering data internally to absorb instantaneous peak traffic. The VPSS DMA master is required to be the highest priority (default) in the system to guarantee functionality. This priority can be lowered (not advised) by modifying the PCR.CPRIORITY register field of the VPSSBL module.

### 4.5.1 Memory Multiplexing

In order to save internal memory space, the buffer logic shares internal memories between modules which wouldn't normally use them at the same time. Memory access multiplexers can be programmed in the VPSSBL so that only one master can access the shared memories at a time. Figure 64 shows all of the shared memories and programmable multiplexer switches in the VPFE.

Figure 64. VPFE Shared Memories and Multiplexers

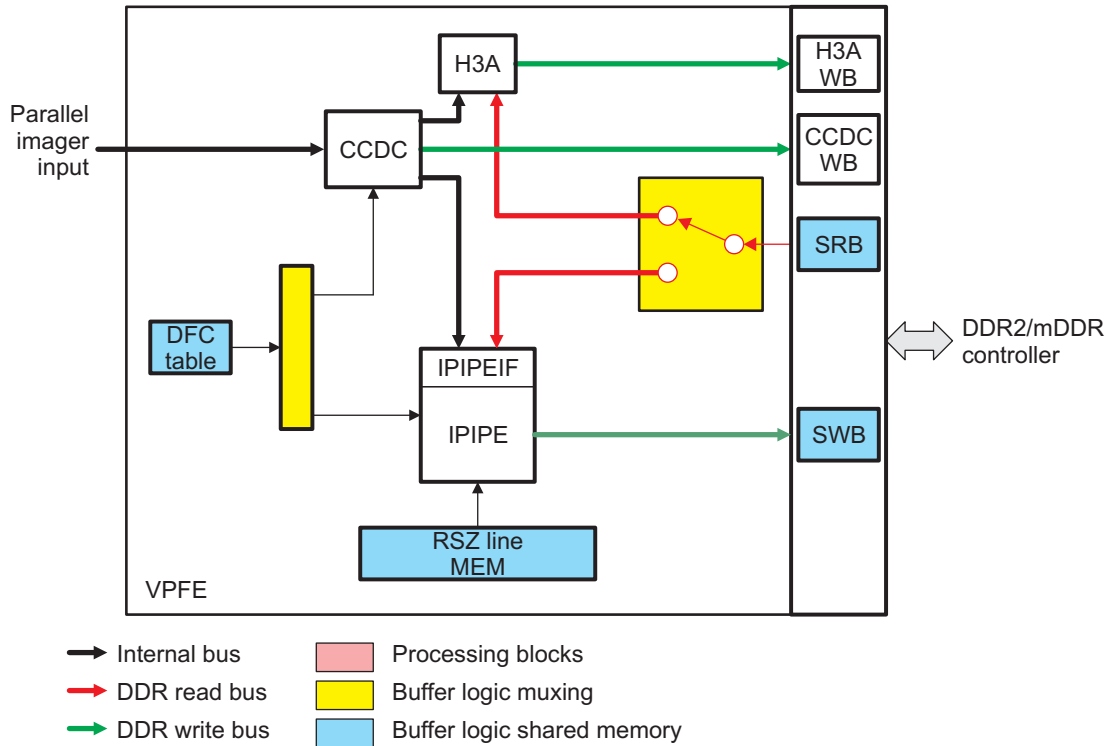


Table 29 outlines the register settings required to assign master modules to the shared memories.

Table 29. VPFE Memory Master Selection

Shared Memory	Register Field	Settings
Shared Read Buffer (SRB)	PCR.RBLCTRL	0: IPIPEIF
		1: Reserved
		2: H3A
Shared Write Buffer (SWB)	PCR.WBLCTRL	0: IPIPEIF
		1: Reserved
DFC Table	MEMCTRL.DFCCTRL	0: IPIPE
		1: CCD
RSZ Line Memory	MEMCTRL.RSZ_CTRL	0: IPIPEIF
		1: Reserved

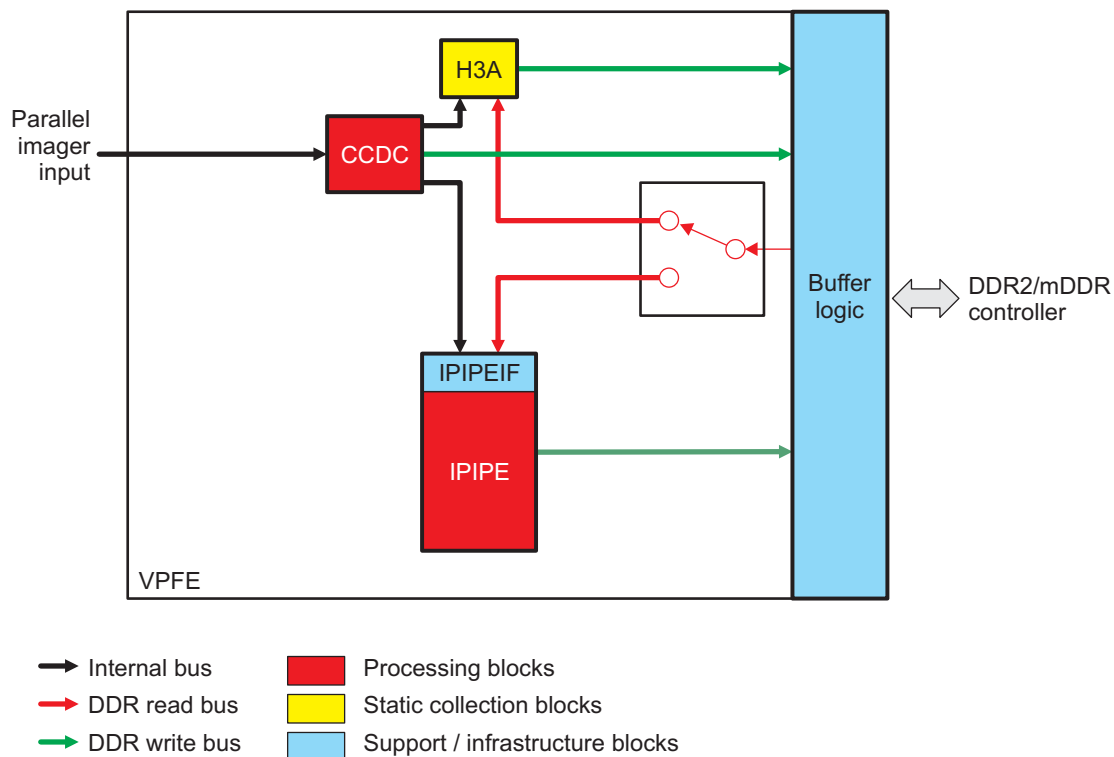
Please note that the CCD does not have write access to the DFC table. So when the CCD will use defect correction, the table must be programmed through the IPIPE memory table registers.

## 5 Programming Model

### 5.1 Setup for Typical Configuration

A typical configuration of the VPFE for a digital camera application would include interfacing to a CCD+TG+AFE imager subsystem. In addition to programming these external devices, the VPFE would be programmed in Preview mode to capture data at a 30 Hz frame rate (draft mode). The VPFE sub-module would be configured to capture/read this data and format for display via the Image Pipe. Simultaneously, the H3A would collect data to be used by user defined focusing algorithms, etc. Figure 65 depicts the VPFE data flow diagram. The interfaces between the modules are configured using the register field values indicated in the diagram. The input to the CCDC is either RAW image data from an AFE or YCC data. The input to the Image Pipe and H3A is only RAW image data.

Figure 65. VPFE Data Flow Diagram



### 5.2 Resetting the Camera Subsystem

The entire VPSS subsystem (VPFE and VPBE) can be reset via the power sleep controller.

### 5.3 Configuring the Clocks and the Control Signals

The input pixel data clock must be provided by the external imager device.

If the VPFE is to be configured in master mode in which the Hd/Vd sync signals are output, then the proper frame definition must be configured in the CCD Controller. Otherwise, in slave mode, the VPFE will sync to the externally provided signals.

### 5.4 Programming the CCD/CMOS Controller (CCDC)

This section discusses issues related to the software control of the CCD/CMOS Controller. It lists which registers are required to be programmed in different modes, how to enable and disable the CCD/CMOS Controller, how to check the status of the CCD/CMOS Controller, discusses the different register access types, and enumerates several programming constraints.

## 5.4.1 Hardware Setup/Initialization

This section discusses the configuration of the CCD/CMOS Controller required before image processing can begin.

### 5.4.1.1 Reset Behavior

Upon hardware reset of the VPSS, all of the registers in the CCD/CMOS Controller are reset to their reset values except the defect table registers. Since the defect table registers are stored in internal RAM, they do not have reset values. If the reset is a chip-level power-on reset (reset after power is applied), then the defect table register values are unknown. If the reset is a VPSS module reset (when power remains active) then the contents of this memory remains the same as before the reset.

### 5.4.1.2 Register Setup

Prior to enabling the CCD/CMOS controller, the hardware must be properly configured via register writes. [Table 30](#) identifies the register parameters that must be programmed before enabling the CCD/CMOS Controller.

**Table 30. CCDC Required Configuration Parameters**

Function	Description
External Pin Signal Configuration	MODESET.VDHDOUT
	MODESET.VDPOL
	MODESET.HDPOL
	MODESET.FLDMODE
	MODESET.FLDPOL
	MODESET.EXWEN
	CCDCFG.VDLC
	CCDCFG.EXTRG
Input Mode	REC656.R656ON
	MODESET.INPMOD
YC Input Swap	CCDCFG.YCINSWP
SDRAM Output Enable	SYNCEN.WEN

[Table 31](#) identifies additional configuration requirements depending on if the corresponding condition is met. It can be read as:

if(Condition is TRUE) then configuration-required parameters must be programmed.

**Table 31. CCDC Conditional Configuration Parameters**

Function	Condition	Configuration Required
VD/HD set as outputs	MODESET.VDHDOUT	HDWIDTH VDWIDTH PPLN LPFR
Interlaced Fields	MODESET.FLDMODE	CCDCFG.FIDMD
External WEN	MODESET.EXWEN	CCDCFG.WENLOG
External Trigger	CCDCFG.EXTRG	CCDCFG.TRGSEL
REC656 Input	REC656.R656ON	REC656.ECCFVH CCDCFG.BW656
YCC Input	MODESET.INPMOD != 0 && !REC656.R656ON	DCSUB.DCSUB
8 bit YCC Input	MODESET.INPMOD == 2 && !REC656.R656ON	CCDCFG.Y8POS

**Table 31. CCDC Conditional Configuration Parameters (continued)**

Function	Condition	Configuration Required
RAW input	MODESET.INPMOD == 0 && !REC656.R656ON	MODESET.DATAPOL CLAMP.CLAMPEN CSCCTL DFCCTL.GDFCEN DFCCTL.VDFCEN LSCCFG1.LSCEN BLKCMP0 BLKCMP1 COLPTN GAMMAWD.CFAP
Optical Black Clamp Enabled	CLAMP.CLAMPEN && MODESET.INPMOD == 0	CLAMP.OBST CLAMP.OBSLEN DCSUB.OBSLN
Optical Black Clamp Disabled	!CLAMP.CLAMPEN && MODESET.INPMOD == 0	DCSUB.DCSUB
CSC Enabled	CSC Enabled	CSCM0, CSCM1, CSCM2, CSCM3, CSCM4, CSCM5, CSCM6, CSCM7
CSC Disabled	!CSCCTL	
CSC Input	CSCCTL	FMTSPH, FMTLNH, FMTSLV, FMTLNV
General Defect Correction	DFCCTL.GDFCEN	VPSSBL.MEMCTRL.DFCCTRL Setup General Defect Table from IPIPE registers.
Vertical Defect Correction	DFCCTL.VDFCEN	DFCCTL.VDFCSL DFCCTL.VDFCUDA DFCCTL.VDFLSFT VDFSLV Setup Vertical Line Defect Table
Lens Shading Correction	LSCCFG1.LSCEN	LSCCFG1.GFMODE LSCCFG2 Setup LSC Table and Coordinates
Write to SDRAM	MODESET.WEN	MODESET.PACK8 CCDCFG.BSWD CCDCFG.MSBINVI SPH, NPH, SLV0, SLV1, NLV, STADRH, STADRL
Write to SDRAM in RAW Mode	MODESET.WEN && MODESET.INPMOD == 0	MODESET.LPF MODESET.DATASFT CULH, CULV, HSIZE, SDOFST, RYEGAIN, GRCYGAIN, GBGGAIN, BMGGAIN, OFFSET, OUTCLIP, GAMMAWD.CCDTBL GAMMAWD.MFIL2
A-law and H3A input bits selection	GAMMAWD.CCDTBL    H3A is receiving data from the CCDC	GAMMAWD.GWID
IPIPE input	MODESET.INPMOD == 0 && IPIPE is receiving data from the CCDC	GAMMAWD.MFILT1
Interrupt Usage	VDINT[1:0] Interrupts are enabled	VDINT0, VDINT1

## 5.4.2 Enable/Disable Hardware

Setting the SYNCEN.VDHDEN bit enables the CCD/CMOS controller. This should be done after all of the required registers mentioned in the previous section are programmed. With respect to the write enable bit and output address, the following procedure must be followed:

1. Set Data output address (STADRH & STADRL).
2. Enable HD/VD and WEN at the same time (MODESET.WEN & SYNCEN.VDHDEN)

If the SYNCEN.VDHDEN bit is written before the output address and SDRAM write enable bit (not recommended but may be required for a particular mode), then data will begin to be written to the old address value and not the one recently programmed. The desired response can be achieved if the following procedure is followed:

1. Enable HD/VD (SYNCEN.VDHDEN)
2. Set output address (STADRH & STADRL)
3. Wait for next VD
4. Enable WEN (SYNCEN.WEN)

The CCD/CMOS controller always operates in continuous mode. In other words, after enabling the CCD/CMOS controller, it will continue to process sequential frames until the SYNCEN.VDHDEN bit is cleared by software. When this happens, the frame being processed will be disabled immediately, and will not continue to process the current frame.

When the CCD/CMOS controller is in master mode (HD/VD signals set to outputs), then fetching and processing of the frame begins immediately upon setting the SYNCEN.VDHDEN bit.

When the CCD/CMOS controller is in slave mode (HD/VD signals set to inputs), then processing of the frame is dependent upon the input timing of the external sensor/decoder. In order to guarantee that data from the external device is not missed, the CCD/CMOS controller should be enabled prior to data transmission from the external device. In this way, the CCD/CMOS controller will wait for data from the external device.

### 5.4.2.1 Enabling/Disabling the SDRAM Output

When enabling or disabling the SDRAM output port (SYNCEN.WEN), the timing of setting the following framing registers can be critical to achieve expected writing behavior: SPH, NPH, SLV0, SLV1, and NLV. In order to avoid potential unexpected data writes to the SDRAM, the following safeguards should be implemented:

- When clearing the SYNCEN.WEN bit to 0, the SDRAM framing registers (SPH, NPH, SLV0, SLV1, and NLV) should be cleared to 0 within the same VD period that the SYNCEN.WEN bit is cleared.
- Likewise, when setting the SYNCEN.WEN bit to 1, these SDRAM framing registers (SPH, NPH, SLV0, SLV1, and NLV) should be set from 0 to the appropriate values within the same VD period that the SYNCEN.WEN bit is set.

## 5.4.3 Events and Status Checking

The CCD/CMOS controller can generate three different interrupts: VDINT0, VDINT1, and VDINT2. Note that the SYNCEN.VDHDEN bit should be enabled to receive any of the CCD/CMOS controller interrupts.

### 5.4.3.1 VDINT0 and VDINT1 Interrupts

As shown in [Figure 66](#), the VDINT0 and VDINT1 interrupts occur relative to the VD pulse. The trigger timing is selected by using MODESET.VDPOL setting. VDINT0 and VDINT1 will occur after receiving the number of horizontal lines (HD pulse signals) set in the VDINT.VDINT0 and VDINT.VDINT1 register fields, respectively.

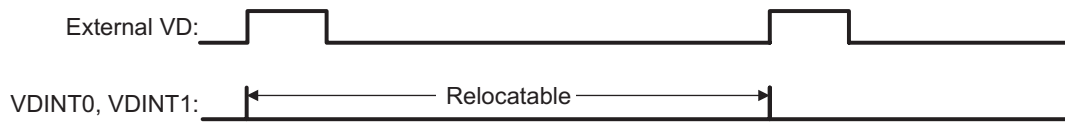
---

**Note:** In the case of BT.656 input mode, there is a VD at the beginning of each field. Therefore, there will be two interrupts for each frame (i.e., one for each field).

---

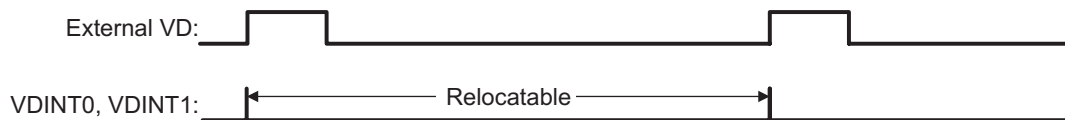
In case of the MODESET.VDPOL being 0, the VDINT0 and VDINT1 HD counters begin counting HD pulses from the rising edge of the external VD.

**Figure 66. VDINT0/VDINT1 Interrupt Behavior When VDPOL = 0**



In case of the MODESET.VDPOL being 1, the VDINT0 and VDINT1 HD counters begin counting HD pulses from the falling edge of the external VD.

**Figure 67. VDINT0/VDINT1 Interrupt Behavior When VDPOL = 1**



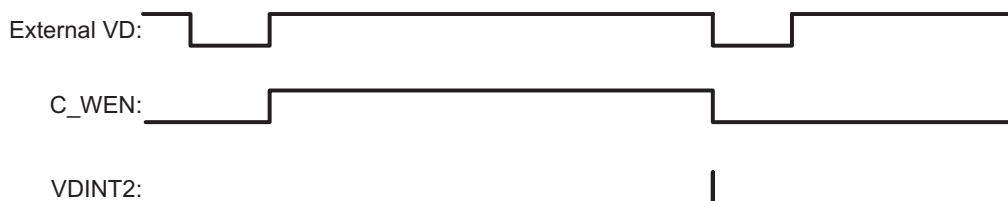
#### 5.4.3.2 VDINT2 Interrupt

In addition to the VDINT0 and VDINT1 interrupts, the CCD/CMOS controller also has an interrupt called the VDINT2 interrupt. The VDINT2 interrupt always occurs at the falling edge of the CAM\_WEN\_FIELD signal (via external pin) if the following conditions are true:

- SYNCEN.VDHDEN = 1
- MODESET.EXWEN = 1
- MODESET.FLDMODE = 0

There are no registers in the CCD/CMOS controller module to configure this interrupt.

**Figure 68. VDINT2 Interrupt Behavior**



#### 5.4.3.3 Status Checking

The MODESET.FLDSTAT bit is set when the field status is on an even field, and it is cleared when the field status is on an odd field.

#### 5.4.4 Register Accessibility During Frame Processing

There are two types of register access in the CCD/CMOS Controller.

**Shadowed Registers (event latched registers)**—*Shadowed* registers are those which can be read and written at any time, but the written values only take effect (are latched) at certain times based on some event. Note that reads will still return the most recent write even though the settings are not used until the specific event occurs.

**Busy-Writable Registers**—These registers/fields can be read or written even if the module is busy. Changes to the underlying settings takes place instantaneously.

The register/field list below can be all set as shadow registers, or optionally set as busy-writable registers. When CCDCFG.VDLC is 0, then these registers are shadowed; when CCDCFG.VDLC is 1, then these registers are busy-writable. All other CCD/CMOS controller registers not included in this list are always busy-writable.

SYNCEN.WEN	SLV1	BLKCMP1	LSCCFG1	CSCM0
MODESET.LPF	CULH	RYEGAIN	LSCCFG2	CSCM1
HDWIDTH	CULV	GRCYGAIN	LSCH0	CSCM2
VDWIDTH	HSIZE	GBGGAIN	LSCV0	CSCM3
PPLN	SDOFST	BMGGAIN	LSCKH	CSCM4
LPFR	STADRH	OFFSET	LSCKV	CSCM5
SPH	SDADRL	GAMMAWD	DFCCTL	CSCM6
NPH	CLAMP.CLAMPEN	FMTSPH	DFCVSAT	CSCM7
SLV0	BLKCMP0	FMTLNH	CSCCTL	

#### 5.4.5 Inter-frame Operations

In between frames, it may be necessary to enable/disable functions or modify the memory pointers. Since the SYNCEN.WEN register and memory pointer registers are shadowed, these modifications can take place any time before the end of the frame, and the data will get latched in for the next frame. The host controller can perform these changes upon receiving an interrupt.

For more details on enabling/disabling the SDRAM output port during processing mode changes (e.g. from preview to still capture mode), see [Section 5.4.2.1](#).

#### 5.4.6 Summary of Constraints

The following is a list of register configuration constraints to adhere to when programming the CCD/CMOS controller. It can be used as a quick checklist. More detailed register setting constraints can be found in the individual register descriptions.

- PCLK must be less than VPSSCLK/2
- If SDRAM output port is enabled:
  - The memory output line offset and address should be on 32-byte boundaries.
  - NPH-1 must be a multiple of 32 bytes.
  - SPH, NPH, SLV0, SLV1, and NLV) should be cleared to 0 within the same VD period that the SYNCEN.WEN bit is cleared to 0.
  - SPH, NPH, SLV0, SLV1, and NLV) should be set from 0 to the appropriate values within the same VD period that the SYNCEN.WEN bit is set to 1.
- External WEN can not be used when at the same time as external FID.
- In RAW input mode,
  - CCDCFG.YCINSWP should be set to 0.

### 5.5 Programming the Image Pipe Interface (IPIPEIF)

This section discusses issues related to the software control of the IPIPE Interface. It lists which registers are required to be programmed in different modes, how to enable and disable the IPIPE Interface, how to check the status of the IPIPE Interface, discusses the different register access types, and enumerates several programming constraints.



## 5.5.1 Hardware Setup/Initialization

This section discusses the configuration of the IPIPE Interface required before image processing can begin.

### 5.5.1.1 Reset Behavior

Upon hardware reset of the VPSS, all of the registers in the IPIPE Interface are reset to their reset values.

### 5.5.1.2 Register Setup

Prior to enabling the IPIPE Interface, the hardware must be properly configured via register writes.

[Table 32](#) identifies the register parameters that must be programmed before enabling the IPIPE Interface.

**Table 32. IPIPE Interface Required Configuration Parameters**

Function	Configuration Required
Input Source	CFG.INPSRC
Input Clock	CFG.CLKSEL
Decimation and Anti-aliasing filter	CFG.DECM CFG.AVGFLT

[Table 33](#) identifies additional configuration requirements depending on if the corresponding condition is met. It can be read as:

if(Condition is TRUE) then

Configuration Required parameters must be programmed

**Table 33. Table 52. IPIPE Interface Conditional Configuration Parameters**

Function	Condition	Configuration Required
Decimation Value	CFG.DECM	RSZ
Clock Divider	CFG.CLKSEL	CFG.CLKDIV
Input from SDRAM	CFG.INPSRC != 0	PPLN LPFR HNUM VNUM ADDRU ADDRL ADOFS VPSSBL.PCR.RBLCTRL
RAW input	CFG.INPSRC = 0,1,2	GAIN
RAW input from SDRAM	CFG.INPSRC = 1,2	CFG.IALAW CFG.PACK8IN
RAW input from SDRAM when Inverse A-law is disabled	CFG.INPSRC = 1,2 && !CFG.IALAW	CFG.DATASFT
Input from SDRAM only	CFG.INPSRC = 1,3	CFG.ONESHOT

## 5.5.2 Enable/Disable Hardware

When CFG.INPSRC = 0, the IPIPEIF does not need to be enabled. It processes whatever the CCDC sends. If CFG.INPSRC != 0, then the IPIPE Interface begins to fetch data from SDRAM by setting ENABLE.ENABLE bit. This should be done after all of the required registers in the IPIPE and IPIPEIF are programmed.

When the input source is the SDRAM/DDRDRAM, the IPIPE Interface can optionally operate in one shot mode or continuous mode by setting the CFG.ONESHOT parameter. If one shot mode is enabled, then after enabling the IPIPE Interface, the ENABLE.ENABLE bit is automatically turned off (set to 0) and only a single frame is processed from memory. In this mode, fetching and processing of the frame begins immediately upon setting the ENABLE.ENABLE bit.

When the input source is the CCD/CMOS Controller processing of the frame is dependent upon the timing of the CCDC. In order to guarantee that data from the CCDC is not missed, the IPIPE Interface should be enabled prior to the CCDC. In this way, the IPIPE Interface will wait for data from the CCDC.

When the IPIPE Interface is in continuous mode, it can be disabled by clearing the ENABLE.ENABLE bit after processing of the last frame. The disable will take place immediately since it is a busy-writable register.

### 5.5.3 Events and Status Checking

The IPIPE Interface will generate an IPIPEIF event to the VPSSBL at the end of each frame.

### 5.5.4 Register Accessibility During Frame Processing

There are two types of register access in the IPIPE Interface.

- Shadow registers

These registers/fields can be read and written (if the field is writeable) at any time. However, the written values take effect only at the start of a frame (VD rising edge). Note that reads will still return the most recent write even though the settings are not used until the next start of frame. The following are the shadowed registers in the IPIPE Interface.

CFG.DECM	HNUM	ADOFS
CFG.AVGFLT	VNUM	RSZ
PPLN	ADDRU	GAIN
LPFR	ADDRL	

- Busy-writable registers

These registers/fields can be read or written even if the module is busy. Changes to the underlying settings takes place instantaneously. The following register fields are busy-writable:

ENABLE	CFG.CLKDIV	CFG.CLKSEL
CFG.ONESHOT	CFG.PACK8IN	CFG.DATASFT
CFG.INPSRC	CFG.IALAW	

The ideal procedure for changing the IPIPE Interface registers is IF (PCR.BUSY == 0) OR IF (EOF interrupt occurs):

- Disable IPIPE interface
- Change registers
- Enable IPIPE interface

### 5.5.5 Inter-Frame Operations

In between frames, it may be necessary to enable/disable functions or modify the memory pointers. Since several of the registers are shadowed, these modifications can take place any time before the end of the frame, and the data will get latched in for the next frame. The host controller can perform these changes upon receiving an interrupt, or an EDMA transfer can be programmed to make these changes upon receiving an event.

### 5.5.6 Summary of Constraints

The following is a list of register configuration constraints to adhere to when programming the IPIPE Interface. It can be used as a quick checklist. More detailed register setting constraints can be found in the individual register descriptions.

- If SDRAM output port is enabled:
  - The memory output line offset and address should be on 32 byte boundaries.
  - Data will be fetched starting on the second HD
  - In Darkframe subtract, LPFR must be > 0 since the first line can not be fetched.

## 5.6 Programming the Image Pipe (IPIPE)

This section discusses issues related to the software control of the IPIPE. It lists which registers are required to be programmed in different modes, how to enable and disable the IPIPE, how to check the status of the IPIPE, discusses the different register access types, and enumerates several programming constraints.

### 5.6.1 Hardware Setup/Initialization

This section discusses the configuration of the IPIPE required before image processing can begin.

#### 5.6.1.1 Reset Behavior

Upon hardware reset of the VPSS, all of the registers in the IPIPE are reset to their reset values. However, since the IPIPE programmable tables (gamma, luminance enhancer, defect correction, and histogram) are stored in internal RAM, their contents do not have reset values. If the reset is a chip-level power-on reset (reset after power is applied), then the contents of these tables are unknown. If the reset is a VPSS module reset (when power remains active) then the contents of these tables remains the same as before the reset.

#### 5.6.1.2 Register Setup

Prior to enabling the IPIPE, the hardware must be properly configured via register writes. In order to write to the IPIPE registers, the GCL\_ARM register must first be set to 1. [Table 34](#) identifies the register parameters that must be programmed before enabling the IPIPE.

**Table 34. IPIPE Required Configuration Parameters**

Function	Description
Function Enable/Disable	IPIPE_MODE
	IPIPE_DPATHS
Input Size	IPIPE_VST
	IPIPE_VSZ
	IPIPE_HST
	IPIPE_HST
Clocks	GCL_CCD
	GCL_SDR
SDRAM Output	RSZ[0].RSZ_SDR_SAD_H
	RSZ[0].RSZ_SDR_SAD_L
VPSSBL Configuration	VPSSBL.PCR.WBLCTRL
	VPSSBL.MEMCTRL.IPIPE_WD_EN
	VPSSBL.MEMCTRL.RESZ_CTRL

[Table 35](#) identifies additional configuration requirements depending on if the corresponding condition is met. It can be read as:

if(Condition is TRUE), then configuration-rrequired parameters must be programmed.

**Table 35. IPIPE Conditional Configuration Parameters**

<b>Function</b>	<b>Condition</b>	<b>Configuration Required</b>	
IPIPE RAW Processing Path Functions	IPIPE_DPATHS < 2	IPIPE_COLPAT	WB2_WG_GB
		DFC_EN	WB2_WG_B
		D2F_EN	
		PRE_EN	YCC_ADJ
		HST_EN	YCC_Y_MIN
		WB2_DGAIN	YCC_Y_MIN
		WB2_WG_R	YCC_C_MIN
		WB2_WG_GR	YCC_C_MAX
IPIPE RAW to YCbCr Processing Path Functions	IPIPE_DPATHS = 0	RGB_MUL_RR	
		RGB_MUL_GR	
		RGB_MUL_BR	YCC_MUL_RY
		RGB_MUL_RG	YCC_MUL_GY
		RGB_MUL_GG	YCC_MUL_BY
		RGB_MUL_BG	YCC_MUL_RCB
		RGB_MUL_RB	YCC_MUL_GCB
		RGB_MUL_GB	YCC_MUL_BCB
		RGB_MUL_BG	YCC_MUL_RCR
		RGB_OFT_OR	YCC_MUL_GCR
		RGB_OFT_OG	YCC_MUL_BCR
		RGB_OFT_OB	YCC_OFT_Y
		GMM_CFG.BYPR	YCC_MUL_CB
		GMM_CFG.BYPG	YCC_MUL_CR
		GMM_CFG.BYPB	YCC_PHS
YCbCr Processing Path Functions	IPIPE_DPATHS != 3	YEE_EN, FCS_EN, RSZ_SEQ, RZA_AAL, RSZ[0].EN, RSZ[1].EN	
Boxcar	IPIPE_DPATHS = 3 && BOX_EN	BOX_MODE BOX_TYP BOX_SHF	
Defect Correction	DFC_EN	DFC_SEL, DFC_ADR, DFC_SIZ, VPSSBL.MEMCTRL.DFCCTRL Setup Defect Table	

**Table 35. IPIPE Conditional Configuration Parameters (continued)**

Function	Condition	Configuration Required
Noise Filter	D2F_EN	D2F_CFG D2F_THR[32] D2F_STR[32]
Pre Filter	PRE_EN	PRE_TYP, PRE_SHF, PRE_GAIN, PRE_THR_G, PRE_THR_B, PRE_THR_1
Histogram	HST_EN	HST_MODE, HST_SEL, HST_PARA, HST[x].HST_VST, HST[x].HST_VSZ HST[x].HST_HST HST[x].HST_HSZ
Gamma Correction	GMM_CFG.BYPR    GMM_CFG.BYPG    GMM_CFG.BYPB	GMM_CFG.TBL GMM_CFG.SIZ Setup Gamma Table(s) if in RAM
Edge Enhancement	YEE_EN	YEE_EMF, YEE_SHF, YEE_MUL_00, YEE_MUL_01, YEE_MUL_02, YEE_MUL_10, YEE_MUL_11, YEE_MUL_12, YEE_MUL_20, YEE_MUL_21, YEE_MUL_22 Setup Luminance Enhancement Table
False Color Suppression	FCS_EN	FSC_TYP, FSC_SHF_Y, FSC_SHF_C, FSC_THR, FSC_SGN, FSC_LTH
RSZ Enabled (where z = 0 or 1)	RSZ[x].EN	RSZ[x].RSZ_MODE RSZ[x].RSZ_I_VST RSZ[x].RSZ_I_HST RSZ[x].RSZ_O_VSZ RSZ[x].RSZ_O_HST RSZ[x].RSZ_O_HSZ RSZ[x].RSZ_V_PHS RSZ[x].RSZ_V_DIF RSZ[x].RSZ_H_PHS RSZ[x].RSZ_H_DIF RSZ[x].RSZ_H_TYP RSZ[x].RSZ_H_LSE RSZ[x].RSZ_RGB_EN RSZ[x].RSZ_SDR_BAD_H RSZ[x].RSZ_SDR_BAD_L RSZ[x].RSZ_SDR_SAD_H RSZ[x].RSZ_SDR_SAD_L RSZ[x].RSZ_SDR_OFT RSZ[x].RSZ_SDR_PTR_S RSZ[x].RSZ_SDR_PTR_E

**Table 35. IPIPE Conditional Configuration Parameters (continued)**

Function	Condition	Configuration Required
RSZ Enabled (where z = 0 or 1)	RSZ[x].EN && !RSZ[x].RSZ_RGB_EN	RSZ[x].RSZ_SDR_BAD_H RSZ[x].RSZ_SDR_BAD_L RSZ[x].RSZ_SDR_SAD_H RSZ[x].RSZ_SDR_SAD_L RSZ[x].RSZ_SDR_OFT RSZ[x].RSZ_SDR_PTR_S RSZ[x].RSZ_SDR_PTR_E
RSZ Input Line Confined Mode	RSZ_SEQ.TMM = 1	RSZ[x].RSZ_I_VSZ
RSZ Horizontal LPF Programmed Value	RSZ[x].RSZ_H_LSE = 1	RSZ[x].RSZ_H_LPF
RSZ RGB Output Configuration	RSZ[x].RSZ_RGB_EN	RSZ[x].RSZ_RGB_TYP
RSZ RGB Alpha Value in 32 Bit Output Mode	RSZ[x].RSZ_RGB_TYP. TYP = 0	RSZ[x].RSZ_RGB_BLD
Interrupt Usage	If IPIPE interrupts are required	IRQ_EN
IRQ RZA Config	IRQ_EN.INT2	IRQ_RZA
IRQ RZB Config	IRQ_EN.INT3	IRQ_RZB

In certain bypass modes, the data still passes through modules which need to be reset to their default values in order to not modify the data being passed through. The following sections identify which registers need to be set to which values in the various bypass modes.

#### 5.6.1.2.1 Resizer Bypass Mode

Since the YCbCr data still passes through the RZA block in resizer bypass mode, the following registers must be set accordingly:

GCK_SDR = 0	RSZ[0].RSZ_V_DIF = 256
RSZ_SEQ.SEQ = 0	RSZ[0].RSZ_H_PHS = 0
RSZ_SEQ.TMM = 0	RSZ[0].RSZ_H_DIF = 256
RSZ_AAL = 0	RSZ[0].RSZ_H_LSE = 0
RSZ[0].RSZ_O_HPS = 0	RSZ[1].RSZ_EN = 0
RSZ[0].RSZ_V_PHS = 0	

#### 5.6.1.2.2 RAW input, RAW output Mode (IPIPE\_DPATHS.FMT = 1)

In this mode, the RAW data bypasses the RAW to YCbCr processes (see [Figure 37](#)), but since it still passes through the YCbCr processing blocks, the following registers must be set accordingly:

IPIPE_DPATHS.FMT = 1	YEE_EN = 0	RSZ[0].RSZ_V_DIF = 256
BOX_EN = 0	FCS_EN = 0	RSZ[0].RSZ_H_PHS = 0
YCC_ADJ.CTR = 16	RSZ_SEQ.TMM = 0	RSZ[0].RSZ_H_DIF = 256
YCC_ADJ.BRT = 0	RSZ[0].RSZ_EN = 1	RSZ[0].RSZ_H_TYP = 0
YCC_Y_MIN = 0	RSZ[0].RSZ_I_VPS = 0	RSZ[0].RSZ_H_LSE = 0
YCC_Y_MAX = 255	RSZ[0].RSZ_I_HPS = 0	RSZ[0].RSZ_H_LPF = 0
YCC_C_MIN = 0	RSZ[0].RSZ_O_HPS = 0	RSZ[0].RSZ_RGB_EN = 0
YCC_C_MAX = 255	RSZ[0].RSZ_V_PHS = 0	RSZ[1].RSZ_EN = 0

### 5.6.1.2.3 RAW Bypass Mode (IPIPE\_DPATHS.FMT = 1 and IPIPE\_DPATHS.BYPASS = 1)

In this mode, the RAW data bypasses the RAW to YCbCr processes (see [Figure 377](#)), but since it still passes through the YCbCr processing blocks, the registers listed in [Section 5.6.1.2.2](#) must be set accordingly. Additionally, since no processing should be done in this mode, the following registers must also be set accordingly:

DFC_EN = 0	WB2_WG_R = 128
D2F_EN = 0	WB2_WG_GR = 128
PRE_EN = 0	WB2_WG_GB = 128
WB2_DGAIN = 256	WB2_WG_B = 128

### 5.6.1.3 Internal Memory Access

The RAM\_xxx registers are used to access the internal RAM of the IPIPE. This RAM is used to store defect correction, gamma correction, and edge enhancement tables, as well as Histogram outputs. If these functions are to be used in the application, then the internal RAM corresponding to these functions must be initialized prior to enabling the IPIPE. Note that the histogram memory is not self-clearing, so it must be initialized to 0s before enabling, and cleared to zeros during reads (write-after-read procedure below).

---

**Note:** In order to access the RAM\_xxx registers, the GCL\_ARM register must first be set to 1 AND the PCLK input to the IPIPE must be enabled. If PCLK is not being driven by an external imager at the time these registers need to be accessed, then the IPIPEIF can be configured to drive the PCLK input to IPIPE by setting the IPIPEIF->CFG.CLKSEL register bit to 1.

---

#### 5.6.1.3.1 Read/Write Procedures

The IPIPE internal memory values can be written, read, and written after read. If multiple values need to be set in incremental addresses, then the RAM\_MODE.ADR bit can be set so that only the first address needs to be set and subsequent reads/writes will auto-increment the internal address. The following procedures should be followed to access the internal memories:

For memory write:

1. Write to RAM\_MODE: set memory selection and set EXT = 0 and WDT = 1.
2. Write to RAM\_ADR: set starting offset into memory.
3. Write to RAM\_WDT: Write data.

For memory read:

1. Write to RAM\_MODE: set memory selection and set EXT = 0 and WDT = 0.
2. Write to RAM\_ADR: set starting offset into memory.
3. Write to RAM\_WDT: Write dummy data.
4. Read the data of the internal memory from RAM\_RDT.

For memory write after read:

1. Write to RAM\_MODE: set memory selection and set EXT = 0 and WDT = 1.
2. Write to RAM\_ADR: set starting offset into memory.
3. Write to RAM\_WDT: Write data.
4. Read the data of the internal memory from RAM\_RDT.

### 5.6.1.3.2 Memory Map

This section indicates how the data is stored in each memory space.

- Histogram 0 and 1

The memory map for histogram changes according to HST\_PARA[BIN].

- (1) HST\_PARA[BIN] = 0 (HST\_PARA[BIN]=0 indicates that the size of a bin of the histogram is 32)

Histogram 0:

Table address [8]	No use
Table address [7..6]	Region number 0~3
Table address [5]	Color number MSB. 0=R, 1=B
Table address [4..0]	Bin number 0~31

Histogram 1:

Table address [8]	No use
Table address [7..6]	Table address [7..6]
Table address [5]	Color number MSB. 0=G, 1=Y
Table address [4..0]	Bin number 0~31

- (2) HST\_PARA[BIN] = 1 (HST\_PARA[BIN]=1 indicates that the size of a bin of the histogram is 64)

Histogram 0:

Table address [8..7]	Region number 0~3
Table address [6]	Color number MSB. 0=R, 1=B
Table address [5..0]	Bin number 0~63

Histogram 1:

Table address [8..7]	Region number 0~3
Table address [6]	Color number MSB. 0=G, 1=Y
Table address [5..0]	Bin number 0~63

- (3) HST\_PARA[BIN] = 3 (HST\_PARA[BIN]=3 indicates that the size of a bin of the histogram is 128)

Histogram 0:

Table address [8]	Region number LSB
Table address [7]	Color number MSB. 0=R, 1=B
Table address [6..0]	Bin number 0~127

Histogram 1:

Table address [8]	Region number LSB
Table address [7]	Color number MSB. 0=G, 1=Y
Table address [6..0]	Bin number 0~127

- (4) HST\_PARA[BIN] = 4 (HST\_PARA[BIN]=4 indicates that the size of a bin of the histogram is 256)

Histogram 0:

Table address [8]	Color number MSB. 0=R, 1=B
Table address [7..0]	Bin number 0~255

Histogram 1:

Table address [8]	Color number MSB. 0=G, 1=Y
Table address [7..0]	Bin number 0~255



Address	Description	WDT/RDT Depth
RAM_ADR[9..0] = 0x0000h	Table address = 0x0000h [15..0]	15..0
RAM_ADR[9..0] = 0x0001h	Table address = 0x0000h [19..16]	3..0
RAM_ADR[9..0] = 0x0002h	Table address = 0x0001h [15..0]	15..0
RAM_ADR[9..0] = 0x0003h	Table address = 0x0001h [19..16]	3..0
RAM_ADR[9..0] = 0x0004h	Table address = 0x0002h [15..0]	15..0
RAM_ADR[9..0] = 0x0005h	Table address = 0x0002h [19..16]	3..0
RAM_ADR[9..0] = 0x03FCh	Table address = 0x01FEh [15..0]	15..0
RAM_ADR[9..0] = 0x03FDh	Table address = 0x01FEh [19..16]	3..0
RAM_ADR[9..0] = 0x03FEh	Table address = 0x01FFh [15..0]	15..0
RAM_ADR[9..0] = 0x03FFh	Table address = 0x01FFh [19..16]	3..0

- Defect Correction

Address	Description	WDT/RDT Depth
RAM_ADR[9..0] = 0x0000h	Defect 0 [11..0]	11..0
RAM_ADR[9..0] = 0x0001h	Defect 0 [26..12]	14..0
RAM_ADR[9..0] = 0x0002h	Defect 1 [11..0]	11..0
RAM_ADR[9..0] = 0x0003h	Defect 1 [26..12]	14..0
RAM_ADR[9..0] = 0x0004h	Defect 2 [11..0]	11..0
RAM_ADR[9..0] = 0x0005h	Defect 2 [26..12]	14..0
RAM_ADR[9..0] = 0x07FCh	Defect 1022 [11..0]	11..0
RAM_ADR[9..0] = 0x07FDh	Defect 1022 [26..12]	14..0
RAM_ADR[9..0] = 0x07FEh	Defect 1023 [11..0]	11..0
RAM_ADR[9..0] = 0x07FFh	Defect 1023 [26..12]	14..0

- Gamma R & G & B & RGB-ALL

Address	Description	WDT/RDT Depth
RAM_ADR[9..0] = 0x0000h	Slope 0	9..0
RAM_ADR[9..0] = 0x0001h	Offset 0	9..0
RAM_ADR[9..0] = 0x0002h	Slope 1	9..0
RAM_ADR[9..0] = 0x0003h	Offset 1	9..0
RAM_ADR[9..0] = 0x0004h	Slope 2	9..0
RAM_ADR[9..0] = 0x0005h	Offset 2	9..0
RAM_ADR[9..0] = 0x03FCh	Slope 510	9..0
RAM_ADR[9..0] = 0x03FDh	Offset 510	9..0
RAM_ADR[9..0] = 0x03FEh	Slope 511	9..0
RAM_ADR[9..0] = 0x03FFh	Offset 511	9..0

- Edge Enhancer

Address	Description	WDT/RDT Depth
RAM_ADR[9..0] = 0x0200h	Parameter HPF = -512	8..0
RAM_ADR[9..0] = 0x0201h	Parameter HPF = -511	8..0
RAM_ADR[9..0] = 0x03FFh	Parameter HPF = -1	8..0
RAM_ADR[9..0] = 0x0000h	Parameter HPF = 0	8..0
RAM_ADR[9..0] = 0x0001h	Parameter HPF = 1	8..0
RAM_ADR[9..0] = 0x01FEh	Parameter HPF = 510	8..0
RAM_ADR[9..0] = 0x01FFh	Parameter HPF = 511	8..0

### 5.6.2 Enable/Disable Hardware

Setting the IPIPE\_EN.EN bit enables the IPIPE. This should be done after all of the required registers and tables mentioned in the previous section are programmed.

When the IPIPE is set to one shot mode, only a single frame is processed. When the IPIPE is in continuous mode, it can be disabled by clearing the IPIPE\_EN.EN bit during the processing of the last frame. The disable will be latched in at the end of the frame it was written in.

### 5.6.3 Events and Status Checking

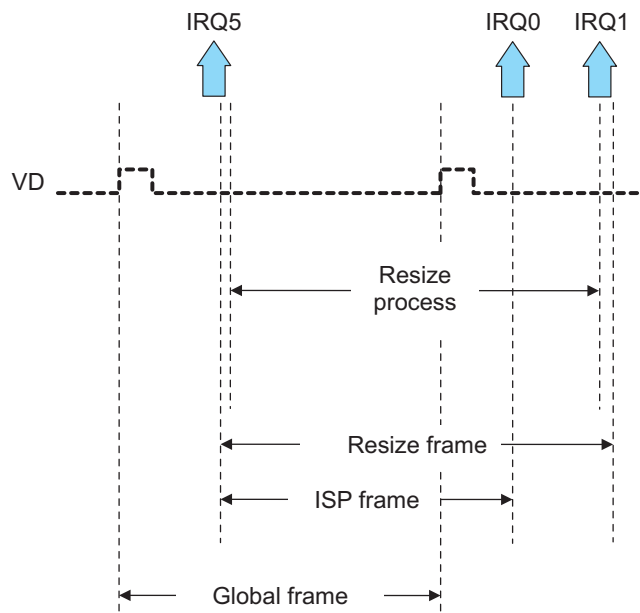
The IPIPE can generate 6 different events to the VPSSBL interrupt and EDMA inputs as outlined in [Table 36](#).

**Table 36. IPIPE Events**

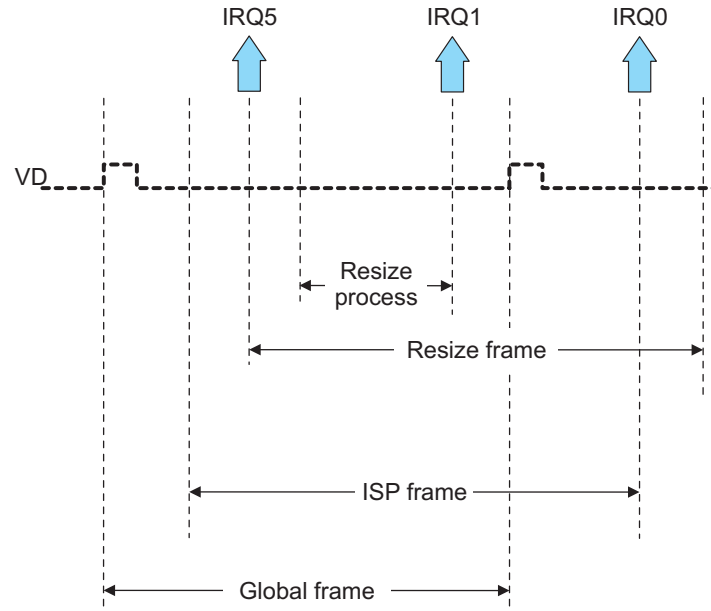
Event	Description
IRQ0	Final pixel from each frame is flushed from the image pipe (not resizer) and histogram completion event
IRQ1	SDRAM Write Completion Event
IRQ2	RZA Interval Completion Event
IRQ3	RZB Interval Completion Event
IRQ5	Register Update Ready Notification Event

Each of these interrupt events can be separately enabled in the IRQ\_EN register. The intervals for RZA and RZB interval completion events (IRQ2 and IRQ3) can be set in the IRQ\_RZA and IRQ\_RZB registers, respectively. The following timing diagrams indicate the relative timing of IRQ0, IRQ1, and IRQ5.

**Figure 69. Interrupt Timing When Resized Area = Resize Frame**



**Figure 70. Interrupt Timing When Resized Area < Resize Frame**



The resizers have the following status registers that are typically used in frame division mode - H and ring buffer output implementation:

**Table 37. IPIPE Resizer Status Registers**

Register	Description
RSZ[x].RSZ_V_PHS_O	Phase of last line in previous resize process
RSZ[x].RSZ_V_SIZ_O	Actual number of output lines in previous resize process.
RSZ[x].RSZ_SDR_PTR_O	Current output line in output buffer

#### 5.6.4 Register Accessibility During Frame Processing

There are two types of register access in the IPIPE: busy-writeable registers, and shadow registers.

- Busy-writeable registers

These registers/fields can be read or written when the module is busy. Changes to the underlying settings takes place instantaneously, therefore it is recommended that they only be written when the module is not busy in order to avoid unintended behavior. The following registers are busy-writable:

IPIPE_MODE	RAM_MODE	RSZ[x].RSZ_MODE
IPIPE_DPATHS	RAM_ADR	HST_MODE
GCL_ARM	RAM_WDT	HST_SEL.SOURCE
GCL_CCD	RAM_RDT	
GCL_SDR	IRQ_EN	

- Shadow registers

These registers/fields can be read and written (if the field is writeable) at any time after receiving the IRQ5 event. However, the written values take effect only at the start of the next frame. Note that reads will still return the most recent write even though the settings are not used until the next start of frame. If these registers are written before receiving the IRQ5 event, the written values may apply to the current frame or the next frame. All the IPIPE registers not listed as "Busy-writable" above are included as "shadow" registers.

## 5.6.5 Inter-Frame Operations

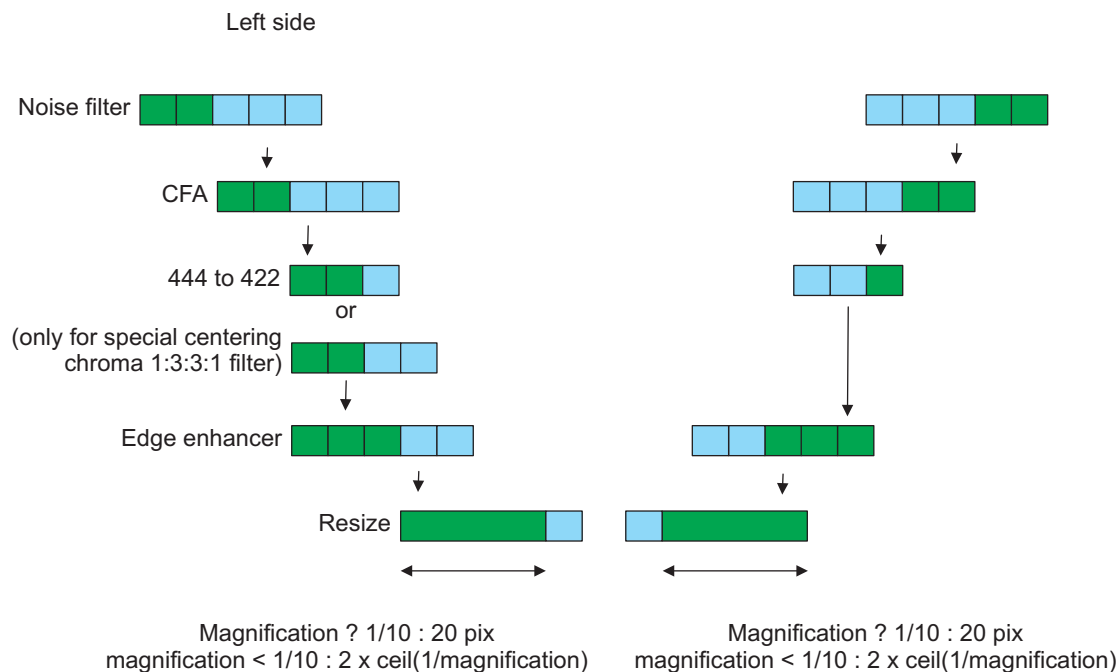
In between frames, it may be necessary to enable/disable functions or modify the memory pointers. Since several registers and the memory pointer registers are shadowed, these modifications can take place any time after the INT5 (update register) interrupt and before the end of the frame, and the data will get latched in for the next frame. The host controller can perform these changes upon receiving an interrupt, or an EDMA transfer can be programmed to make these changes upon receiving an event.

In between frames, it may be necessary to enable/disable functions or modify the memory pointers. Since several registers and the memory pointer registers are shadowed, these modifications can take place any time after the INT5 (update register) interrupt and before the end of the frame, and the data will get latched in for the next frame. The host controller can perform these changes upon receiving an interrupt, or an EDMA transfer can be programmed to make these changes upon receiving an event.

### 5.6.5.1 Overhead Lines and Pixels

Filtering processes in IPIPE creates overhead pixels at each side (left/right/top/bottom). Figure 71 shows the lateral (left/right) overhead of each process. Noise Filter and CFA have two pixels of overhead at each side. The 444 to 422 module has one overhead pixel except when interpolation is in 1:3:3:1 mode. When in 1:3:3:1 mode, the 444 to 422 module has two overhead pixels. Edge Enhancer has three overhead pixels. Each resizer has variable overhead pixels depending on magnification rate. As a rule of thumb, the overhead for the Resizer can be described by the following equation.

**Figure 71. Lateral Overhead Pixels**



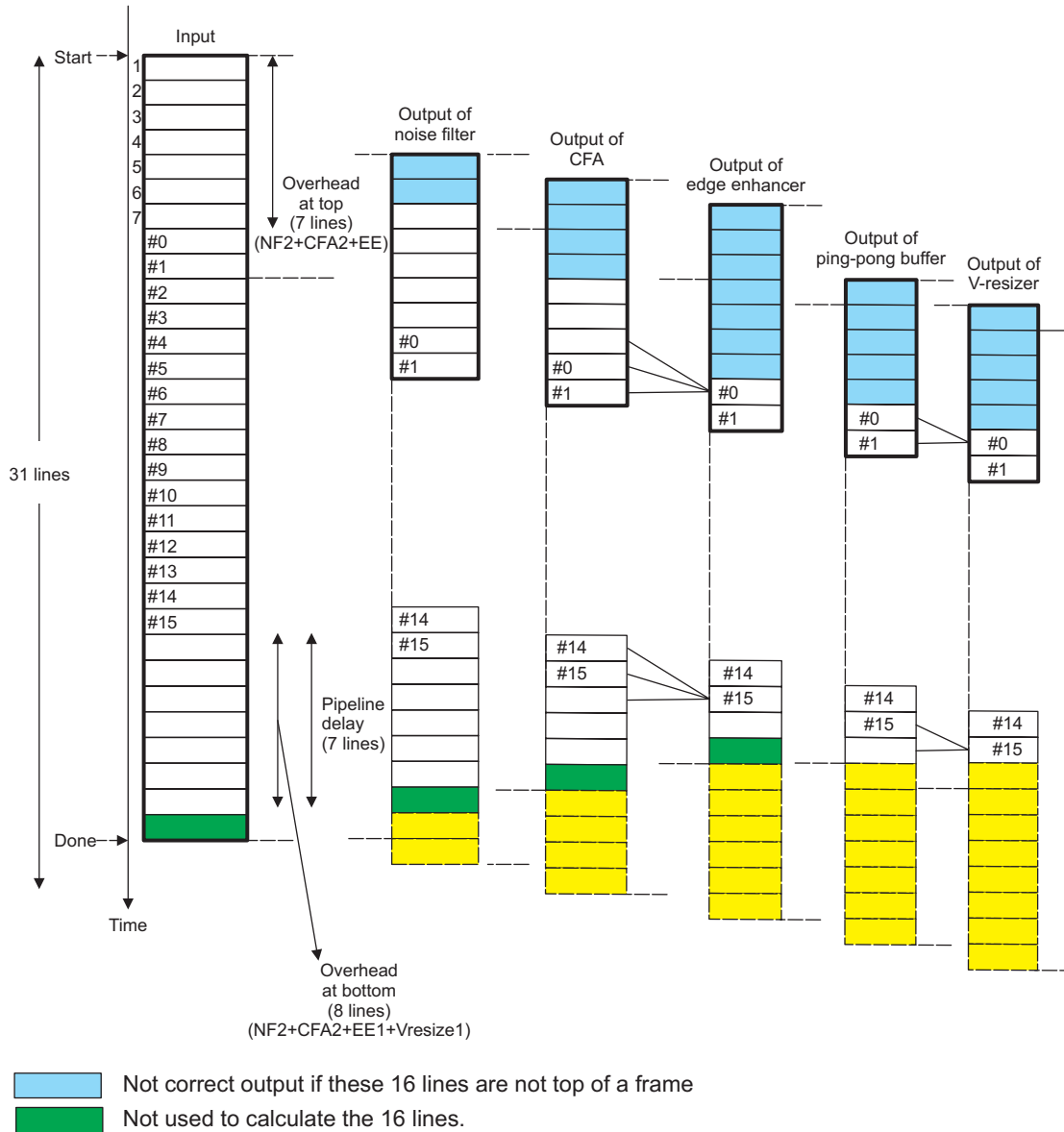
Ex) Mag ? 1/10 & co-sided C => 28/side  
Mag = 1/16 (recommended minimum) & co-sided C -> 40/side

 : overhead

ceil (x) = the smallest integer that is greater or equal to x

In the vertical direction, the noise filter module and the CFA module have two lines of overhead at top and bottom. The edge enhancer has three overhead lines at the both sides. The resizer has an overhead line only at the bottom. In addition to these overheads, the ping-pong buffer before resizer module consumes 1-line of pipeline delay. This delay does not affect output data. These overhead lines are described in Figure 72.

Figure 72. Vertical Overhead Pixels



### 5.6.5.2 Frame Division Mode

IPIPE supports input images split into sub-blocks (frame division mode). The overheads at the boundaries of each block are masked by the resizer module. In the following section, examples of these operations are described.

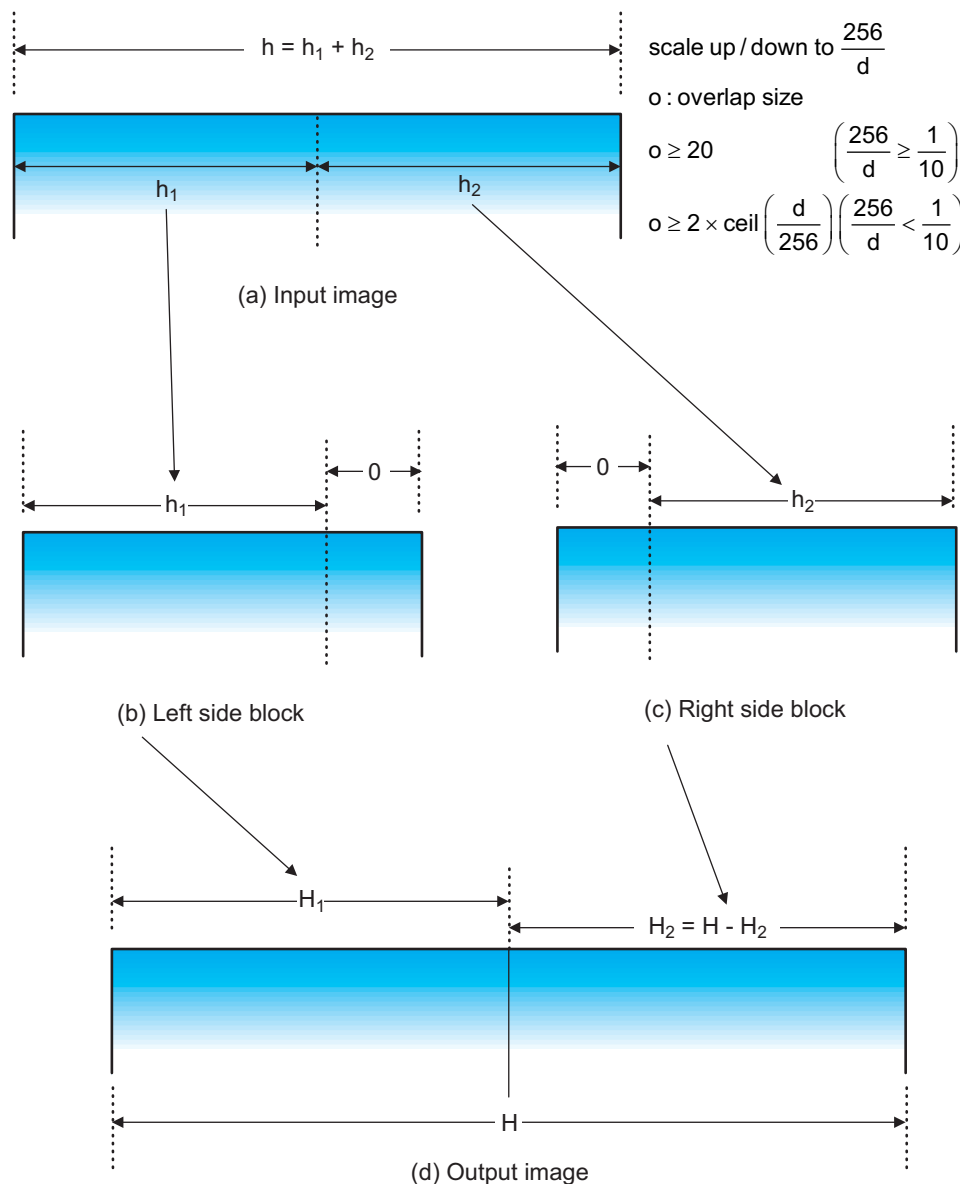
### 5.6.5.2.1 Frame Division Mode-V

In *Frame Division Mode-V*, the input image is horizontally split into multiple images as shown in [Figure 73](#). Each image at right or left is processed separately, and the output is merged in SDRAM to make a single output image. Following are the example of the settings of RZA for this mode (same settings can apply to RZB).

The input image is split into the left side block with width of  $h_1$  and the right side block with width of  $h_2$ . Each image is resized to the ratio of  $256/d$  to make images with width of  $H_0$  and  $H_2 = H - H_0$  respectively. These two images form the target image with width of  $H$  ([Figure 73d](#)).

An example of parameters for resizing of left side blocks and right side blocks are shown in [Figure 74](#). For the matching of the output from left side block and right side block, a certain amount of overlap pixels are required. The minimum overlap size is 20 for  $d \leq 2560$ , and  $2 \times \text{ceil}(d/256)$  for  $d > 2560$ . When other processes, such as CFA, are working, larger overlap is required (See [Section 5.6.5.1](#)).

**Figure 73. Frame Division Mode - V**



**Figure 74. Register Settings for Frame Division Mode - V**

<p> input_h_position = 0  output_h_position = 0  <math display="block">\text{tmp\_size} = \text{floor} \left( (h_1 - 1) \times \frac{256}{d} \right)</math> <math display="block">\text{output\_h\_size} = \begin{cases} \text{tmp\_size} + 1 &amp; \text{if tmp\_size is odd} \\ \text{tmp\_size} &amp; \text{if tmp\_size is even} \end{cases}</math> h_initial_phase = 0   RSZ[0].RSZ_I_HST = input_h_position  RSZ[0].RSZ_O_HST = output_h_position  RSZ[0].RSZ_O_HSZ = output_h_size-1  RSZ[0].RSZ_H_PHS = h_initial_phase </p> <p>(a) register setting for left side blocks</p>	$X_0 = 2 \times \text{ceil} \left( \frac{(x_0 \times 256)}{d} \right)$ $x_1 = 2 \times \text{floor} \left( \frac{\left( \frac{X_0 \times d}{256} \right)}{2} \right)$ <p> input_h_size = h<sub>2</sub> + o  input_h_position = x<sub>1</sub> - x<sub>0</sub>  output_h_position = H<sub>1</sub> - X<sub>0</sub>  output_h_size = H<sub>2</sub> = H - H<sub>1</sub>  h_initial_phase = X<sub>0</sub> × d - x<sub>1</sub> × 256 </p> <p> RSZ[0].RSZ_I_HST = input_h_position  RSZ[0].RSZ_O_HST = output_h_position  RSZ[0].RSZ_O_HSZ = output_h_size-1  RSZ[0].RSZ_H_PHS = h_initial_phase </p> <p>(b) register setting for right side blocks</p>
---	---

input\_h\_size : The width of input image for that block.  
input\_h\_position : The pixel at which resize modules start proceeding.  
output\_h\_position : The number of pixels to skip in the produced image.  
output\_h\_size : The number of pixels to output.  
h\_initial\_phase : The first interpolation ratio in horizontal direction.

Note:   ceil(x): the smallest interger number not smaller than x  
          floor(x): the largest interger number not larger than x

5.6.5.2.1.1 Frame Division Mode-H

This section describes the example of parameter setting values in frame division mode-H, where the input image is split into several boxes (Figure 75).

In this section, it is assumed that the width of the input image is  $h$  and the height  $v$ . Also, those of the output image are  $H$  and  $V$ . The input image is split into left side and right side. Left side blocks have the dimension of  $h_1$  by  $b$ , right side blocks  $h_2$  by  $b$ , as shown in Figure 75b. Each block is scaled up or down to the size of  $256/d$  to form a part of the target image.

The input image is split into blocks as shown in Figure 75. In this section, the blocks are numbered from left to right, top to bottom. Therefore, block -  $2n$  is the left side block at the  $n$ -th row. Also, block -  $(2m + 1)$  is the right side block at the  $m$ -th row. Each block need one overlap line between vertical adjacent blocks. Each block also needs some more overlap lines (overlap1 lines at the top and overlap2 lines at the bottom where  $overlap_1 = overlap_2$ ) for other processes such as CFA. Therefore, the height of each input block after the first row of blocks should be  $(b + 1 + overlap_1 + overlap_2)$  as shown in Figure 75b.

Figure 75. Frame Division Mode - H

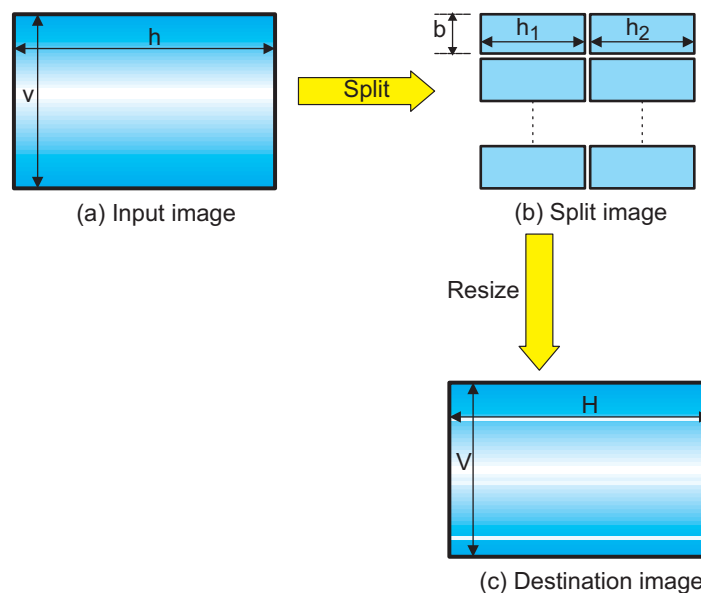
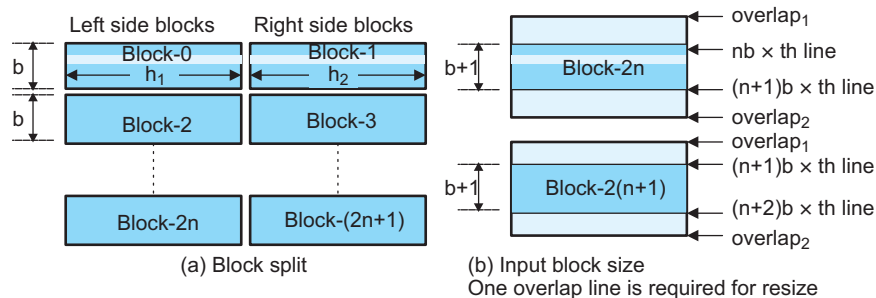


Figure 76. Blocks in Frame Division Mode - H



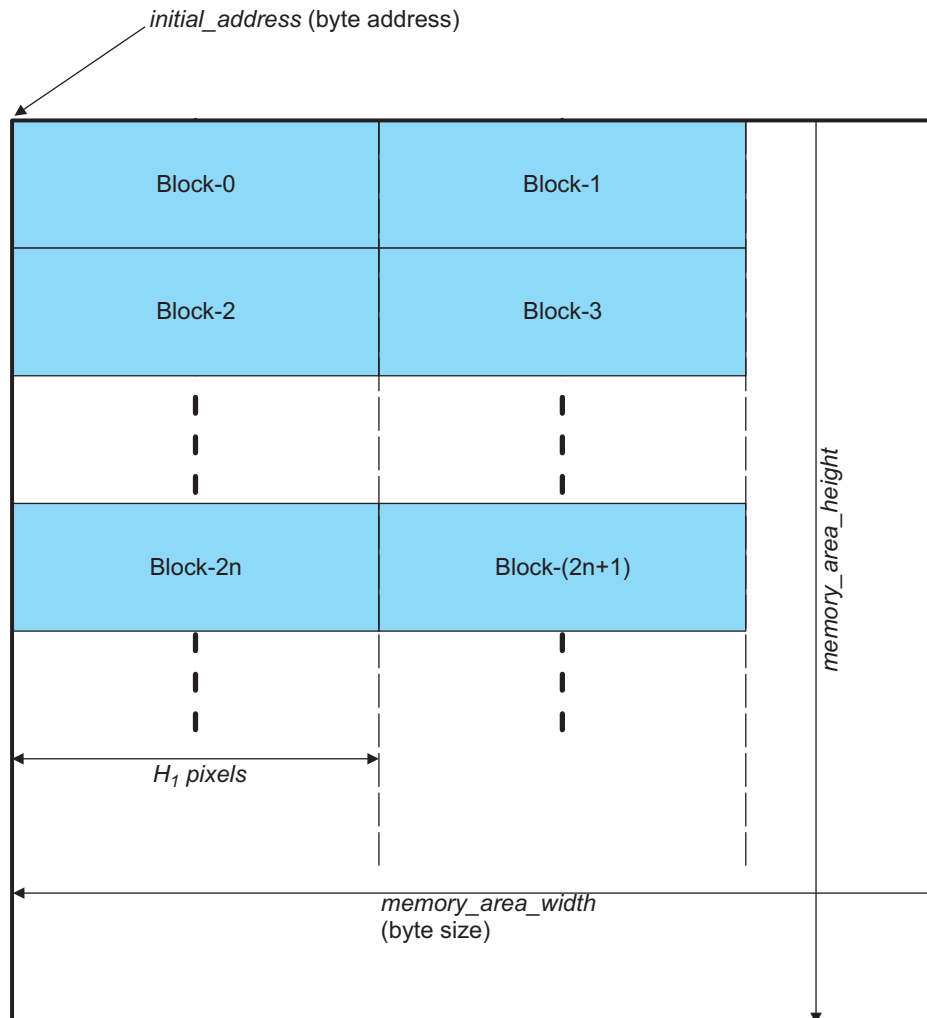




The output image will be placed in memory area as shown in [Figure 78](#). In this figure, the first address of the destination area is *initial\_address* (in byte address) and width of the area is *memory\_area\_width* (bytes). Also the area has the height of *memory\_area\_height* lines. Also, the output image of the blocks at the left has the width of  $H_1$  pixels.

For the blocks at the left (block 0, 2, 4, ...), the register setting should be the values shown in [Figure 79a](#). Here,  $rps_{last}$  is the register value of RSZ[0].RSZ\_SDR\_PTR\_O written by IPIPE module for the blocks of previous row. This value shows the next destination line in the memory area. For block - 2n, RSZ[0].RSZ\_SDR\_PTR\_O for block - 2(n - 1) should be used as  $rps_{last}$ . For the block at the right, the register setting are shown in [Figure 79b](#).

**Figure 78. Register Settings for Frame Division Mode - H**



**Figure 79. Memory Settings for Frame Division Mode - H**

Left side blocks (block 0, 2, ..., 2n,

$$\begin{aligned} \text{RSZ}[0].\text{RSZ\_SDR\_BAD} &= \text{initial\_address} \\ \text{RSZ}[0].\text{RSZ\_SDR\_SAD} &= \text{initial\_address} + \text{memory\_width} \times \text{rsp}_{new} \\ \text{RSZ}[0].\text{RSZ\_SDR\_OFT} &= \text{memory\_width} \\ \text{RSZ}[0].\text{RSZ\_SDR\_PTR\_S} &= \text{rsp}_{new} \end{aligned}$$

(a). Register setting for left side

Right side blocks (block 1, 3, ..., 2n+1,

$$\begin{aligned} \text{RSZ}[0].\text{RSZ\_SDR\_BAD} &= \text{initial\_address} + 2H_1 \\ \text{RSZ}[0].\text{RSZ\_SDR\_SAD} &= \text{initial\_address} + 2H_1 + \text{memory\_width} \times \text{rsp}_{new} \\ \text{RSZ}[0].\text{RSZ\_SDR\_OFT} &= \text{memory\_width} \\ \text{RSZ}[0].\text{RSZ\_SDR\_PTR\_S} &= \text{rsp}_{new} \end{aligned}$$

(b). Register setting for right side

$$\text{rsp}_{new} = \begin{cases} (\text{RSZ}[0].\text{RSZ\_SDR\_PTR\_O} + 1) \bmod \text{memory\_height} & \text{RSZ}[0].\text{RSZ\_V\_SIZ\_O} > 0 \\ \text{RSZ}[0].\text{RSZ\_SDR\_PTR\_O} & \text{RSZ}[0].\text{RSZ\_V\_SIZ\_O} = 0 \end{cases}$$

$\text{rsp}_{new}$  : The line in memory space where the next line will be placed.

$\text{RZA\_SDR\_PTR\_O}$  : The line pointer at which the last output is written. this register value is written by ISP module.

### 5.6.6 Summary of Constraints

The following is a list of register configuration constraints to adhere to when programming the IPIPE. It can be used as a quick checklist. More detailed register setting constraints can be found in the individual register descriptions.

- The first input pixel should be the RED pixel in order for the register names to be aligned with the appropriate colors.
- Both the input and output widths should be less than or equal to 1344 pixels.
- $\text{RSZ}[1]$  output width should be less than or equal to 640 pixels.
- Input height and width should be equal to or smaller than CCD/CMOS Controller output height and width.
- Output width should be even
- Each input line should have at least  $\text{IPIPE\_HSZ} + 1 + 8$  PCLK cycles.
- Each input frame should have at least  $\text{IPIPE\_VSZ} + 1 + 10$  HD pulses (+4 in continuous mode).
- Resize ratios are limited to the range from 1/16x scale down to 8x scale up.

## 5.7 Programming the Hardware 3A (H3A)

This section discusses issues related to the software control of the H3A module. It lists which registers are required to be programmed in different modes, how to enable and disable the H3A, how to check the status of the H3A, discusses the different register access types, and enumerates several programming constraints.

### 5.7.1 Hardware Setup/Initialization

This section discusses the configuration of the H3A required before image processing can begin.

#### 5.7.1.1 Reset Behavior

Upon hardware reset of the VPSS, all of the registers in the H3A are reset to their reset values.

#### 5.7.1.2 Register Setup

For register configuration purposes, the AF Engine and the AEW Engine of the H3A can independently be configured. There are separate enable bits for each engine, so this section will be divided into the AF engine and the AEW engine.

##### 5.7.1.2.1 AF Engine

Prior to enabling the AF engine, the hardware must be properly configured via register writes. [Table 38](#) identifies the register parameters that must be programmed before enabling the AF engine of the H3A.

**Table 38. AF Engine Required Configuration Parameters**

Function	Configuration Required
Input Source	PCR.INP_SRC
AF Optional Preprocessing	PCR.AF_MED_EN, PCR.AF_ALAW_EN
AF Mode Configuration	PCR.RGBPOS, PCR.FVMODE
Paxel Start and Size Information	AFPAX1, AFPAX2, AFPAXSTART, AFIIRSH
Memory Address	AFBUFST
Filter Coefficients	AFCOEF0[10:0] , AFCOEF1[10:0]

[Table 39](#) identifies additional configuration requirements depending on if the corresponding condition is met. It can be read as:

if(Condition is TRUE), then configuration-required parameters must be programmed.

**Table 39. AF Engine Conditional Configuration Parameters**

Function	Condition	Configuration Required
Horz. Median Filter	PCR.AF_MED_EN	PCR.MED_TH
DDR2/mDDR controller input	PCR.INP_SRC	PCR.INP_WIDTH, RSDR_ADDR, RADR_OFFSET SDR_FRSIZE.HSIZE, SDR_FRSIZE.VSIZE
Bit Selection	!PCD.INP_WIDTH	SDR_FRSIZE.BITSEL

The following references offer guidelines on how to program the filter coefficients and make use of the H3A output.

- M. Gamadia, V. Peddigari, N. Kehtarnavaz, S-Y. Lee, G. Cook, *Real-time Implementation of Auto Focus on the TI DSC Processor*, Proceedings of SPIE Real-Time Imaging Conference, Jan 2004
- N. Kehtarnavaz, H-J. Oh, *Development and Real-Time Implementation of a Rule-Based Auto-Focus Algorithm*, Journal of Real-Time Imaging, 9, 197-203, 2003

### 5.7.1.2.2 AEW Engine

Prior to enabling the AEW Engine, the hardware must be properly configured via register writes. [Table 40](#) identifies the register parameters that must be programmed before enabling the AEW Engine of the H3A.

**Table 40. AEW Engine Required Configuration Parameters**

Function	Configuration Required
Input Source	PCR.INP_SRC
AEW Optional Preprocessing	PCR.AEW_ALAW_EN
Saturation Limit	PCR.AVE2LMT
Window Start and Size Information	AEWWIN1, AEWINSTART, AEWINBLK, AEWSUBWIN
Memory Address	AEWBUFST

[Table 41](#) identifies additional configuration requirements depending on if the corresponding condition is met. It can be read as:

if(Condition is TRUE) then

Configuration Required parameters must be programmed

**Table 41. AEW Engine Conditional Configuration Parameters**

Function	Condition	Configuration Required
DDR2/mDDR controller Input	PCR.INP_SRC	PCR.INP_WIDTH RSDR_ADDR, RADR_OFFSET SDR_FRSIZE.HSIZE, SDR_FRSIZE.VSIZE
Bit Selection	!PCD.INP_WIDTH	SDR_FRSIZE.BITSEL

### 5.7.2 Enable/Disable Hardware

Setting the PCR.AF\_EN bit enables the AF engine, and the PCR.AEW\_EN bit enables the AEW engine. This should be done after all of the required registers mentioned in the previous section are programmed.

When the input source is SDRAM, the H3A operates in one-shot mode. In addition to the enable bits mentioned above, the PCR.SDR\_FETCH\_EN bit must be set for each frame processed from SDRAM.

When the input source is the video port interface of the CCD/CMOS controller, the H3A operates in continuous mode. In this mode, processing of the frame is dependent upon the timing of the CCD controller. In order to guarantee that data from the CCD controller is not missed, the H3A should be enabled prior to the CCD controller. In this way, the H3A will wait for data from the CCD controller. The AF engine or the AEW engine can be disabled by clearing the PCR.AF\_EN or PCR.AEW\_EN bit, respectively, during the processing of the last frame. The disable will be latched in at the end of the frame in which it was written.

### 5.7.3 Events and Status Checking

Both the AF engine and the AEW engine generates an interrupt and an EDMA event at the end of processing each frame. However, these two interrupts are internally tied together so that only one H3A interrupt signal (and H3A EDMA event) is seen by the interrupt controller (and EDMA). If the AF engine and AEW engine are not processing the same frame concurrently, then this shouldn't be an issue. However, if both the AF and AEW engines are running concurrently, then one of two outcomes may occur:

- The H3A interrupt may seem to only trigger once for each frame. This can happen when the processing for both the AF Engine and the AEW engine is finished at/near the same time. The interrupt service routine does not have enough time to clear the interrupt flag for the first interrupt before the second interrupt occurs.

- The H3A interrupt may trigger twice for each frame. This can happen when either the AF engine or the AEW engine finishes processing the frame much earlier than the other one. In this case, the interrupt service routine does not have enough time to clear the interrupt flag for the first interrupt by the time the second interrupt occurs.

The outcome is dependent on the difference in location of the last paxel/window in the frame (determines when processing is finished), the frequency of the relative clocks in the system, the occurrence and triggering of other interrupts in the system, and the latencies of the context switching and interrupt service routine execution.

The PCR.BUSYAF and/or PCR.BUSYAEAWB status bits are set when the start of frame occurs (if the PCR.AF\_EN and/or PCR.AEW\_EN bits are 1 at that time). They are automatically reset to 0 at the end of processing a frame. The PCR.BUSYAF and/or PCR.BUSYAEAWB status bits may be polled to determine the end of frame status.

#### 5.7.4 Register Accessibility During Frame Processing

There are two types of register access in the H3A module.

- Shadow registers
  - These registers/fields can be read and written (if the field is writeable) at any time. However, the written values take effect only at the start of a frame. Note that reads will still return the most recent write even though the settings are not used until the next start of frame.
  - The PCR, AFBUFST, and AEWBUFST registers are the only shadowed registers in the H3A module.
- Busy-lock registers
  - All registers EXCEPT the PCR, AFBUFST, and AEWBUFST registers belong to this category.
  - Busy-lock registers cannot be written when the module is busy. Writes will be allowed to occur, but no change will occur in the registers (blocked writes from hardware perspective, but allowed write from the software perspective). Once the busy bit in the PCR register is reset to 0, the busy-lock registers can be written.

The ideal procedure for changing the H3A registers is

IF (busy == 0) OR IF (EOF interrupt occurs):

DISABLE AF or AE/AWB

CHANGE REGISTERS

ENABLE AF or AE/AWB

#### 5.7.5 Inter-Frame Operations

In between frames, it may be necessary to modify the memory pointers before processing the next frame. Since the PCR and memory pointer registers are shadowed, these modifications can take place any time before the end of the frame, and the data will get latched in for the next frame. The host controller can perform these changes upon receiving an interrupt, or an EDMA transfer can be programmed to make these changes upon receiving an event.

#### 5.7.6 Summary of Constraints

The following is a list of register configuration constraints to adhere to when programming the H3A. It can be used as a quick checklist. More detailed register setting constraints can be found in the individual register descriptions.

- The output addresses must be on 64-byte boundaries

AF Engine:

- The paxel horizontal start value must be greater than or equal to the IIR horizontal start position.
- The width and height of the paxels must be an even number.
- The minimum width of the auto focus paxel must be 8 pixels.

- Paxels cannot overlap the last pixel in a line.
- Paxels must be adjacent to one another.

AEW Engine:

- The width and height of the windows must be an even number.
- Sub-sampling windows can only start on even numbers.
- The minimum width of the AE/AWB windows must be 8 pixels.

## 5.8 Programming the Buffer Logic (VPSSBL and VPSSCLK Registers)

This section discusses issues related to the software control of the VPSS Buffer Logic. The VPSS Buffer Logic comprises the infrastructure data path switches, interrupt control multiplexing, and clock gating control within the VPSS. This section briefly lists which registers are required to be programmed in different configurations of the VPSS.

### 5.8.1 Hardware Setup/Initialization

This section discusses the configuration of the VPSSBL and VPSSCLK required before image processing can begin.

#### 5.8.1.1 Reset Behavior

Upon hardware reset of the VPSS, all of the registers in the VPSSBL and VPSSCLK register modules are reset to their reset values.

#### 5.8.1.2 Register Setup

Prior to enabling the modules within the VPSS, the buffer logic hardware must be properly configured via register writes. [Table 42](#) identifies the register parameters that must be programmed properly before enabling the various modules. The items not bolded are optional, depending on if the operational mode of the module requires the setting or not.

**Table 42. VPSSBL and VPSSCLK Required Configuration Parameters**

Function	Configuration Required
CCDC	VPSSBL.MEMCTRL.DFCCTRL <b>VPSSCLK.CLKCTRL.CCDCCLK</b>
IPIPEIF	<b>VPSSBL.PCR.RBLCTRL</b> <b>VPSSCLK.CLKCTRL.IPIPECLK</b>
IPIPE	<b>VPSSBL.PCR.WBLCTRL</b> <b>VPSSBL.MEMCTRL.IPIPE_WD_EN</b> <b>VPSSBL.MEMCTRL.RESZ_CTRL</b> VPSSBL.MEMCTRL.DFCCTRL <b>VPSSCLK.CLKCTRL.IPIPECLK</b>
H3A	<b>VPSSBL.PCR.RBLCTRL</b> <b>VPSSCLK.CLKCTRL.H3ACKL</b>

### 5.8.2 Events and Status Checking

The VPSSBL controls the selection of which module interrupts are routed to the ARM interrupt controller and EDMA event controllers using the VPSSBL.INTSEL and VPSSBL.EVTSEL registers. The VPSSBL.INTSTAT register can also be used to poll for events. For more details, see [Section 3.2](#).

### 5.8.3 Register Accessibility During Frame Processing

There is only one type of register access in the VPSSBL and VPSSCLK modules.

**Busy-Writeable Registers**—These registers/fields can be read or written even if the module is busy. Changes to the underlying settings takes place instantaneously.

### 5.8.4 Inter-Frame Operations

Since the VPSSBL and VPSSCLK registers are busy-writable, care must be taken when modifying any of these registers. It is recommended that affected modules be disabled while switching modes and modifying any of these registers.

### 5.8.5 Summary of Constraints

None noted.



## 6 Registers

There are eight sub-modules associated with the Video Processing Front End subsystem, as show in [Table 43](#).

**Table 43. Video Processing Front End Sub-Module Register Map**

Address	Acronym	Register Description	Section
0x01C7:0600	CCDC	CCD Controller	<a href="#">Section 6.1</a>
0x01C7:0100	IPIPEIF	Image Pipe IF	<a href="#">Section 6.2</a>
0x01C7:1000	IPIPE	Image Pipe	<a href="#">Section 6.3</a>
0x01C7:0080	H3A	Hardware 3A	<a href="#">Section 6.4</a>
0x01C7:0800	VPSSBL	VPSS Buffer Logic	<a href="#">Section 6.5</a>
0x01C7:0000	VPSSCLK	VPSS Clock Control	<a href="#">Section 6.6</a>

### 6.1 CCD Controller (CCDC) Registers

The CCD controller (CCDC) registers are shown in [Table 44](#).

**Table 44. CCD Controller (CCDC) Registers**

Address	Acronym	Register Description	Section
0x01C7:0600	SYNCEN	Synchronization Enable Register	<a href="#">Section 6.1.1</a>
0x01C7:0604	MODESET	Mode Setup Register	<a href="#">Section 6.1.2</a>
0x01C7:0608	HDWIDTH	HD Pulse Width Register	<a href="#">Section 6.1.3</a>
0x01C7:060C	VDWIDTH	VD Pulse Width Register	<a href="#">Section 6.1.4</a>
0x01C7:0610	PPLN	Pixels Per Line Register	<a href="#">Section 6.1.5</a>
0x01C7:0614	LPFR	Lines Per Frame Register	<a href="#">Section 6.1.6</a>
0x01C7:0618	SPH	Start Pixel Horizontal Register	<a href="#">Section 6.1.7</a>
0x01C7:061C	NPH	Number Of Pixels Horizontal Register	<a href="#">Section 6.1.8</a>
0x01C7:0620	SLV0	Start Line Vertical - Field 0 Register	<a href="#">Section 6.1.9</a>
0x01C7:0624	SLV1	Start Line Vertical - Field 1 Register	<a href="#">Section 6.1.10</a>
0x01C7:0628	NLV	Number Of Lines Vertical Register	<a href="#">Section 6.1.11</a>
0x01C7:062C	CULH	Culling - Horizontal Register	<a href="#">Section 6.1.12</a>
0x01C7:0630	CULV	Culling - Vertical Register	<a href="#">Section 6.1.13</a>
0x01C7:0634	HSIZE	Horizontal Size Register	<a href="#">Section 6.1.14</a>
0x01C7:0638	SDOFST	SDRAM Line Offset Register	<a href="#">Section 6.1.15</a>
0x01C7:063C	STADRH	SDRAM Address - High Register	<a href="#">Section 6.1.16</a>
0x01C7:0640	STADRL	SDRAM Address - Low Register	<a href="#">Section 6.1.17</a>
0x01C7:0644	CLAMP	CCD Data Clamping Register	<a href="#">Section 6.1.18</a>
0x01C7:0648	DCSUB	DC Clamp Register	<a href="#">Section 6.1.19</a>
0x01C7:064C	COLPTN	CCD Color Pattern Register	<a href="#">Section 6.1.20</a>
0x01C7:0650	BLKCMP0	Black Compensation #1 Register	<a href="#">Section 6.1.21</a>
0x01C7:0654	BLKCMP1	Black Compensation #2 Register	<a href="#">Section 6.1.22</a>
0x01C7:0658	MEDFILT	CCD Median Filter Register	<a href="#">Section 6.1.23</a>
0x01C7:065C	RYEGAIN	CCD Gain Adjustment - R/Ye Register	<a href="#">Section 6.1.24</a>
0x01C7:0660	GRCYGAIN	CCD Gain Adjustment - Gr/Cy Register	<a href="#">Section 6.1.25</a>
0x01C7:0664	GBGGAIN	CCD Gain Adjustment - Gb/G Register	<a href="#">Section 6.1.26</a>
0x01C7:0668	BMGGAIN	CCD Gain Adjustment - B/Mg Register	<a href="#">Section 6.1.27</a>
0x01C7:066C	OFFSET	CCD Offset Adjustment Register	<a href="#">Section 6.1.28</a>
0x01C7:0670	OUTCLIP	Output Clipping Value Register	<a href="#">Section 6.1.29</a>
0x01C7:0674	VDINT0	VD Interrupt #0 Register	<a href="#">Section 6.1.30</a>

**Table 44. CCD Controller (CCDC) Registers (continued)**

Address	Acronym	Register Description	Section
0x01C7:0678	VDINT1	VD Interrupt #1 Register	<a href="#">Section 6.1.31</a>
0x01C7:0680	GAMMAWD	Gamma Correction Settings Register	<a href="#">Section 6.1.32</a>
0x01C7:0684	REC656IF	REC656 Control Register	<a href="#">Section 6.1.33</a>
0x01C7:0688	CCDCFG	CCD Configuration Register	<a href="#">Section 6.1.34</a>
0x01C7:0694	FMTSPH	Start Pixel Horizontal Register	<a href="#">Section 6.1.35</a>
0x01C7:0698	FMTLNH	Number Of Pixels Register	<a href="#">Section 6.1.36</a>
0x01C7:069C	FMTSLV	Start Line Vertical Register	<a href="#">Section 6.1.37</a>
0x01C7:06A0	FMTLNV	Number Of Lines Register	<a href="#">Section 6.1.38</a>
0x01C7:06F4	LSCCFG1	Lens Shading Correction Configuration 1 Register	<a href="#">Section 6.1.39</a>
0x01C7:06F8	LSCCFG2	Lens Shading Correction Configuration 2 Register	<a href="#">Section 6.1.40</a>
0x01C7:06FC	LSCH0	Lens Shading Correction - Center Position (H0) Register	<a href="#">Section 6.1.41</a>
0x01C7:0700	LSCV0	Lens Shading Correction - Center Position (V0) Register	<a href="#">Section 6.1.42</a>
0x01C7:0704	LSCKH	Lens Shading Correction - Horizontal Coefficients Register	<a href="#">Section 6.1.43</a>
0x01C7:0708	LSCKV	Lens Shading Correction - Vertical Coefficients Register	<a href="#">Section 6.1.44</a>
0x01C7:070C	LSCMEMCTL	Lens Shading Correction - Memory Control Register	<a href="#">Section 6.1.45</a>
0x01C7:0710	LSCMEMD	Lens Shading Correction - Memory Write Data Register	<a href="#">Section 6.1.46</a>
0x01C7:0714	LSCMEMQ	Lens Shading Correction - Memory Read Data Register	<a href="#">Section 6.1.47</a>
0x01C7:0718	DFCCTL	Defect Correction - Control Register	<a href="#">Section 6.1.48</a>
0x01C7:071C	DFCVSAT	Defect Correction - Vertical Saturation Level Register	<a href="#">Section 6.1.49</a>
0x01C7:0720	DFCMEMCTL	Defect Correction - Memory Control Register	<a href="#">Section 6.1.50</a>
0x01C7:0724	DFCMEM0	Defect Correction - Set V Position Register	<a href="#">Section 6.1.51</a>
0x01C7:0728	DFCMEM1	Defect Correction - Set H Position Register	<a href="#">Section 6.1.52</a>
0x01C7:072C	DFCMEM2	Defect Correction - Set SUB1 Register	<a href="#">Section 6.1.53</a>
0x01C7:0730	DFCMEM3	Defect Correction - Set SUB2 Register	<a href="#">Section 6.1.54</a>
0x01C7:0734	DFCMEM4	Defect Correction - Set SUB3 Register	<a href="#">Section 6.1.55</a>
0x01C7:0738	CSCCTL	Color Space Converter Enable Register	<a href="#">Section 6.1.56</a>
0x01C7:073C	CSCM0	Color Space Converter - Coefficients #0 Register	<a href="#">Section 6.1.57</a>
0x01C7:0740	CSCM1	Color Space Converter - Coefficients #1 Register	<a href="#">Section 6.1.58</a>
0x01C7:0744	CSCM2	Color Space Converter - Coefficients #2 Register	<a href="#">Section 6.1.59</a>
0x01C7:0748	CSCM3	Color Space Converter - Coefficients #3 Register	<a href="#">Section 6.1.60</a>
0x01C7:074C	CSCM4	Color Space Converter - Coefficients #4 Register	<a href="#">Section 6.1.61</a>
0x01C7:0750	CSCM5	Color Space Converter - Coefficients #5 Register	<a href="#">Section 6.1.62</a>
0x01C7:0754	CSCM6	Color Space Converter - Coefficients #6 Register	<a href="#">Section 6.1.63</a>
0x01C7:0758	CSCM7	Color Space Converter - Coefficients #7 Register	<a href="#">Section 6.1.64</a>
0x01C7:075C	DATAOFST	Data Offset Register	<a href="#">Section 6.1.65</a>

### 6.1.1 Synchronization Enable Register (SYNCEN)

The synchronization enable register (SYNCEN) is shown in [Figure 80](#) and described in [Table 45](#).

**Figure 80. Synchronization Enable Register (SYNCEN)**

15	2	1	0
Reserved		WEN	VDHDEN
R-0		R/W-0	R/W-0

LEGEND: R/W = Read/Write; R = Read only; -n = value after reset

**Table 45. Synchronization Enable Register (SYNCEN) Field Descriptions**

Bit	Field	Value	Description
15-2	Reserved	0	Reserved
1	WEN	0	Data Write Enable. Controls whether or not CCD raw data is written to SDRAM. This bit is latched by VD. Disable.
		1	Enable.
0	VDHDEN	0	VD/HD Enable. If VD/HD are defined as output, activates internal timing generator. If VD/HD are defined as inputs, activates internal timing generator to synchronize with VD/HD. Disable.
		1	Enable

### 6.1.2 Mode Setup Register (MODESET)

The mode setup register (MODESET) is shown in [Figure 81](#) and described in [Table 46](#).

**Figure 81. Mode Setup Register (MODESET)**

15	14	13	12	11	10	8	
FLDSTAT	LPF	INPMOD		PACK8	DATASFT		
R-0	R/W-0	R/W-2		R/W-0	R/W-0		
7	6	5	4	3	2	1	0
FLDMODE	DATAPOL	EXWEN	FLDPOL	HDPOL	VDPOL	Reserved	VDHDOUT
R/W-0	R/W-0	R/W-0	R/W-0	R/W-0	R/W-0	R-0	R/W-0

LEGEND: R/W = Read/Write; R = Read only; -n = value after reset

**Table 46. Mode Setup Register (MODESET) Field Descriptions**

Bit	Field	Value	Description
15	FLDSTAT	0 1	Field Status. Odd field Even field
14	LPF	0 1	3-tap Low-Pass (anti-aliasing) filter. 1/4, 1/2, 1/4 filtering applied to CCD data. This bit is latched by VD. Off On
13-12	INPMOD	0 1 2 3	Data input mode. CCD RAW data. YCbCr 16-bit. YCbCr 8-bit. Reserved.
11	PACK8	0 1	Pack to 8-bits/pixel (into SDRAM). Normal (16 bits/pixel). Pack to 8-bits/pixel.
10-8	DATASFT	0 1 2 3 4 5 6 7	CCD Data Right Shift for Data Written to SDRAM valid only when INPMOD is set to 0. No shift. 1-bit 2-bits 3-bits 4-bits 5-bits 6-bits Reserved
7	FLDMODE	0 1	Sensor field mode. This bit should not be set if the EXWEN bit is set. Non-interlaced (progressive). Interlaced.
6	DATAPOL	0 1	CCD data polarity. Normal (no change). One's complement.

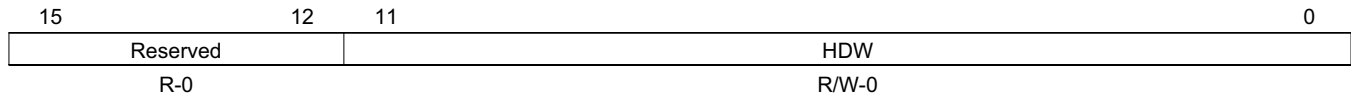
**Table 46. Mode Setup Register (MODESET) Field Descriptions (continued)**

Bit	Field	Value	Description
5	EXWEN		External WEN selection. When set to 1 and when ENABLE is set to 1, the external WEN signal is used as the external memory write enable (to SDRAM/DDRAM). The data is stored to memory only when the external sync (HD and VD) signals are active.  This bit should not be set if the FLDMODE bit is set.
		0	Do not use external WEN (Write Enable).
		1	Use external WEN (Write Enable).
4	FLDPOL	0	Field indicator polarity. Positive
		1	Negative
3	HDPOL	0	HD sync polarity. Positive
		1	Negative
2	VDPOL	0	VD sync polarity. Positive
		1	Negative
1	Reserved.	0	Reserved.
0	VDHDOUT	0	VD/HD sync direction. Input
		1	Output

### 6.1.3 HD Pulse Width Register (HDWIDTH)

The HD pulse width register (HDWIDTH) is shown in [Figure 82](#) and described in [Table 47](#).

**Figure 82. HD Pulse Width Register (HDWIDTH)**



LEGEND: R/W = Read/Write; R = Read only; -n = value after reset

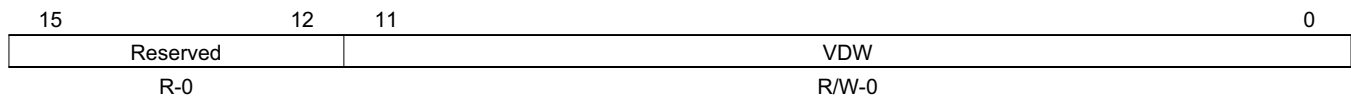
**Table 47. HD Pulse Width Register (HDWIDTH) Field Descriptions**

Bit	Field	Value	Description
15-12	Reserved	0	Reserved.
11-0	HDW	0-FFFh	Width of HD sync pulse if output: HDW + 1 pixel clocks. HDWIDTH is not used when HD is input, i.e. when VDHDOUT in MODESET is cleared to 0. This bit field is latched by VD.

### 6.1.4 VD Pulse Width Register (VDWIDTH)

The VD pulse width register (VDWIDTH) is shown in [Figure 83](#) and described in [Table 48](#).

**Figure 83. VD Pulse Width Register (VDWIDTH)**



LEGEND: R/W = Read/Write; R = Read only; -n = value after reset

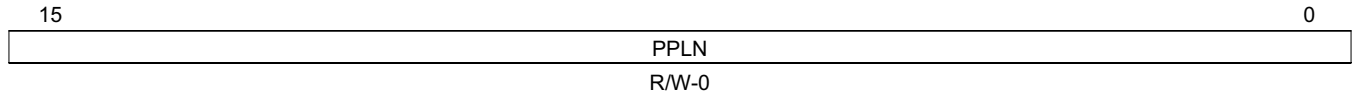
**Table 48. VD Pulse Width Register (VDWIDTH) Field Descriptions**

Bit	Field	Value	Description
15-12	Reserved	0	Reserved.
11-0	VDW	0-FFFh	Width of VD sync pulse if output: VDW + 1 lines. VDWIDTH is not used when VD is input, i.e. when VDHDOUT in MODESET is cleared to 0. This bit field is latched by VD.

### 6.1.5 Pixels Per Line Register (PPLN)

The pixels per line register (PPLN) is shown in [Figure 84](#) and described in [Table 49](#).

**Figure 84. Pixels Per Line Register (PPLN)**



LEGEND: R/W = Read/Write; -n = value after reset

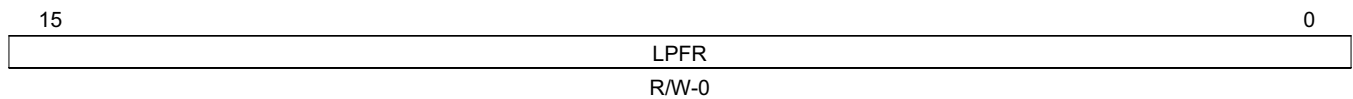
**Table 49. Pixels Per Line Register (PPLN) Field Descriptions**

Bit	Field	Value	Description
15-0	PPLN	0-FFFFh	Pixels per line. Number of pixel clock periods in one line. HD period = PPLN + 1 pixel clocks PPLN is not used when HD and VD are inputs, i.e. when VDHDOUT in MODESET is cleared to 0. This bit field is latched by VD.

### 6.1.6 Lines Per Frame Register (LPFR)

The lines per frame register (LPFR) is shown in [Figure 85](#) and described in [Table 50](#).

**Figure 85. Lines Per Frame Register (LPFR)**



LEGEND: R/W = Read/Write; -n = value after reset

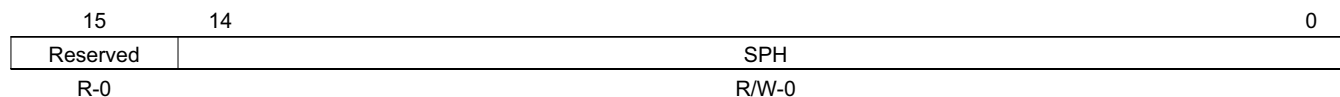
**Table 50. Lines Per Frame Register (LPFR) Field Descriptions**

Bit	Field	Value	Description
15-0	LPFR	0-FFFFh	Half lines per field or frame. Sets number of half lines per frame or field. VD period = (HLPFR + 1)/2 lines LPFR is not used when HD and are inputs, i.e. when VDHDOUT in MODESET is cleared to 0. This bit field is latched by VD.

### 6.1.7 Start Pixel Horizontal Register (SPH)

The start pixel horizontal register (SPH) is shown in [Figure 86](#) and described in [Table 51](#).

**Figure 86. Start Pixel Horizontal Register (SPH)**



LEGEND: R/W = Read/Write; R = Read only; -n = value after reset

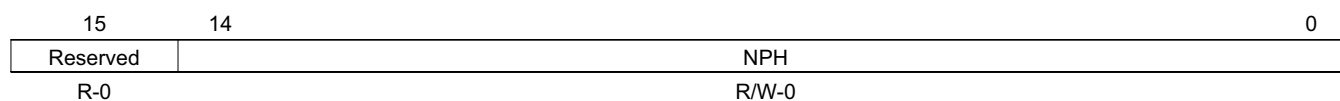
**Table 51. Start Pixel Horizontal Register (SPH) Field Descriptions**

Bit	Field	Value	Description
15	Reserved	0	Reserved.
14-0	SPH	0-7FFFh	Start pixel, horizontal. Sets pixel clock position at which data output to SDRAM begins, measured from the start of HD. This bit field is latched by VD.

### 6.1.8 Number of Pixels Horizontal Register (NPH)

The number of pixels horizontal register (NPH) is shown in [Figure 87](#) and described in [Table 52](#).

**Figure 87. Number of Pixels Horizontal Register (NPH)**



LEGEND: R/W = Read/Write; R = Read only; -n = value after reset

**Table 52. Number of Pixels Horizontal Register (NPH) Field Descriptions**

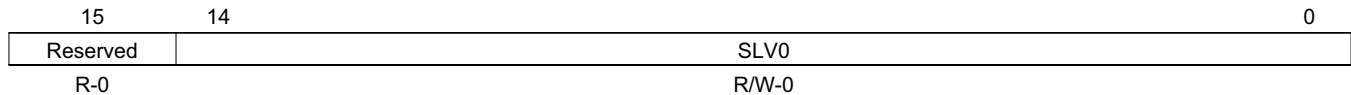
Bit	Field	Value	Description
15	Reserved	0	Reserved.
14-0	NPH	0-7FFFh	Number of pixels, horizontal. Sets number of horizontal pixels that will be output to SDRAM = (NPH + 1) and 0xFFF0, i.e. the number of horizontal output pixels is truncated to multiples of 16. This bit field is latched by VD.



### 6.1.9 Start Line Vertical - Field 0 Register (SLV0)

The start line vertical - field 0 register (SLV0) is shown in [Figure 88](#) and described in [Table 53](#).

**Figure 88. Start Line Vertical - Field 0 Register (SLV0)**



LEGEND: R/W = Read/Write; R = Read only; -n = value after reset

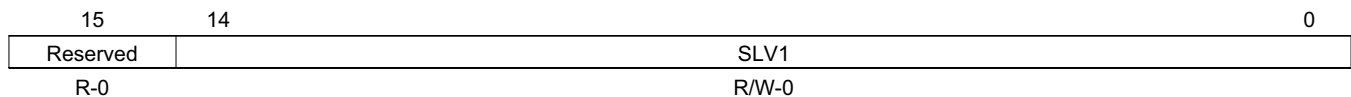
**Table 53. Start Line Vertical - Field 0 Register (SLV0) Field Descriptions**

Bit	Field	Value	Description
15	Reserved	0	Reserved.
14-0	SLV0	0-7FFFh	Start Line, Vertical (Field 0). Sets line at which data output to SDRAM will begin, measured from the start of VD. This bit field is latched by VD.

### 6.1.10 Start Line Vertical - Field 1 Register (SLV1)

The start line vertical - field 1 register (SLV1) is shown in [Figure 89](#) and described in [Table 54](#).

**Figure 89. Start Line Vertical - Field 1 Register (SLV1)**



LEGEND: R/W = Read/Write; R = Read only; -n = value after reset

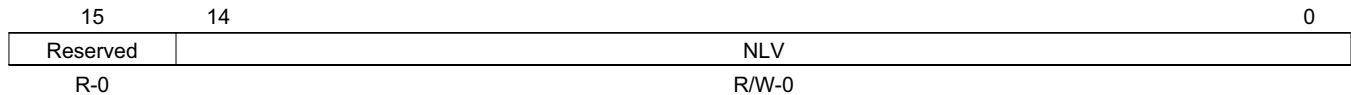
**Table 54. Start Line Vertical - Field 1 Register (SLV1) Field Descriptions**

Bit	Field	Value	Description
15	Reserved	0	Reserved.
14-0	SLV1	0-7FFFh	Start Line, Vertical (Field 1). Sets line at which data output to SDRAM will begin, measured from the start of VD. This bit field is latched by VD.

### 6.1.11 Number of Lines Vertical Register (NLV)

The number of lines vertical register (NLV) is shown in [Figure 90](#) and described in [Table 55](#).

**Figure 90. Number of Lines Vertical Register (NLV)**



LEGEND: R/W = Read/Write; R = Read only; -n = value after reset

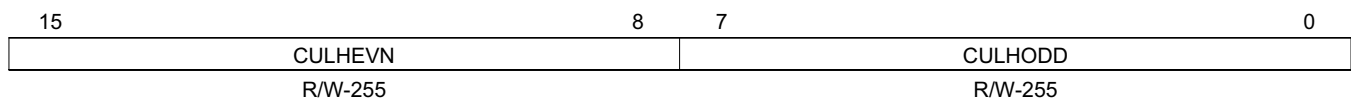
**Table 55. Number of Lines Vertical Register (NLV) Field Descriptions**

Bit	Field	Value	Description
15	Reserved	0	Reserved.
14-0	NLV	0-7FFFh	Number of lines, vertical. Sets number of vertical lines that will be output to SDRAM. The number of lines output to SDRAM = (NLV + 1). This bit field is latched by VD.

### 6.1.12 Culling Horizontal Register (CULH)

The culling horizontal register (CULH) is shown in [Figure 91](#) and described in [Table 56](#).

**Figure 91. Culling Horizontal Register (CULH)**



LEGEND: R/W = Read/Write; -n = value after reset

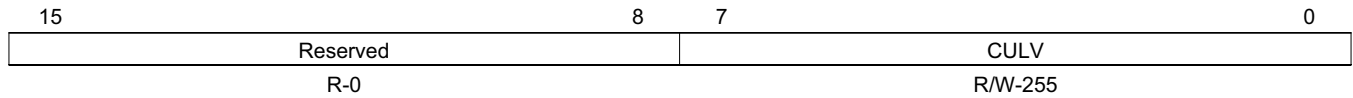
**Table 56. Culling Horizontal Register (CULH) Field Descriptions**

Bit	Field	Value	Description
15-8	CULHEVN	0 Cull. 1 Retain.	Horizontal culling pattern for even line. When writing to SDRAM, 8_bit mask: LSB is first pixel, MSB is 8th pixel, then pattern repeats. This bit field is latched by VD.
7-0	CULHODD	0 Cull. 1 Retain.	Horizontal culling pattern for odd line. When writing to SDRAM, 8_bit mask: LSB is first pixel, MSB is 8th pixel, then pattern repeats. This bit field is latched by VD.

### 6.1.13 Culling Vertical Register (CULV)

The culling vertical register (CULV) is shown in [Figure 92](#) and described in [Table 57](#).

**Figure 92. Culling Vertical Register (CULV)**



LEGEND: R/W = Read/Write; R = Read only; -n = value after reset

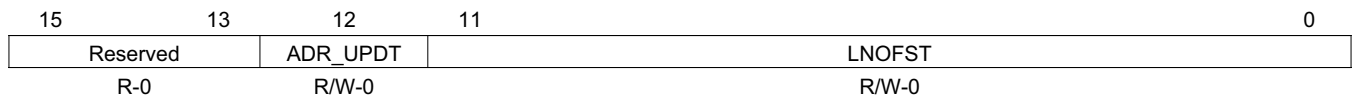
**Table 57. Culling Vertical Register (CULV) Field Descriptions**

Bit	Field	Value	Description
15-8	Reserved	0	Reserved.
7-0	CULV	0 1	Vertical culling pattern. 8_bit mask: 0 Cull. 1 Retain. LSB is first line, MSB is 8th line, then pattern repeats. This bit field is latched by VD.

### 6.1.14 Horizontal Size Register (HSIZE)

The horizontal size register (HSIZE) is shown in [Figure 93](#) and described in [Table 58](#).

**Figure 93. Horizontal Size Register (HSIZE)**



LEGEND: R/W = Read/Write; R = Read only; -n = value after reset

**Table 58. Horizontal Size Register (HSIZE) Field Descriptions**

Bit	Field	Value	Description
15-13	Reserved	0	Reserved. Read as zero.
12	ADR_UPDT	0 1	SDRAM address update. By setting this bit, SDRAM address in a line is automatically decreased so that a line can be horizontally flipped in the SDRAM. This bit field is latched by VD. 0 Address increment. 1 Address decrement.
11-0	LNOFST	0-FFFh	Address offset for each line. Sets size of line in SDRAM, units: 32 bytes. Either 16 or 32 pixels depending on setting of PACK8. This bit field is latched by VD.

### 6.1.15 SDRAM Line Offset Register (SDOFST)

The SDRAM line offset register (SDOFST) is shown in [Figure 94](#) and described in [Table 59](#).

**Figure 94. SDRAM Line Offset Register (SDOFST)**

15	14	13	12	11	9	8	6	5	3	2	0
Reserved	FIINV	FOFST	LOFST0	LOFST1	LOFST2	LOFST3					
R-0	R/W-0	R/W-0	R/W-0	R/W-0	R/W-0	R/W-0					

LEGEND: R/W = Read/Write; R = Read only; -n = value after reset

**Table 59. SDRAM Line Offset Register (SDOFST) Field Descriptions**

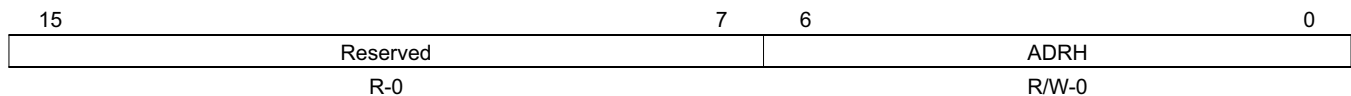
Bit	Field	Value	Description
15	Reserved	0	Reserved.
14	FIINV	0 1	Field identification signal inverse. This field is latched by VD. 0 Non inverse. 1 Inverse.
13-12	FOFST	0 1 2 3	Line offset value of odd field (FID = 1). This field is latched by VD. 0 +1 line. 1 +2 line. 2 +3 line. 3 +4 line.
11-9	LOFST0	0 1 2 3 4 5 6 7	Line offset values of even line and even field (FID = 0). This field is latched by VD. 0 +1 line. 1 +2 lines. 2 +3 lines. 3 +4 lines. 4 -1 line. 5 -2 lines. 6 -3 lines. 7 -4 lines.
8-6	LOFST1	0 1 2 3 4 5 6 7	Line offset values of odd line and even field (FID = 0). This bit is latched by VD. 0 +1 line. 1 +2 lines. 2 +3 lines. 3 +4 lines. 4 -1 line. 5 -2 lines. 6 -3 lines. 7 -4 lines.

**Table 59. SDRAM Line Offset Register (SDFST) Field Descriptions (continued)**

Bit	Field	Value	Description
5-3	LOFTS2	0 1 2 3 4 5 6 7	Line offset values of even line and odd field (FID = 1). This bit is latched by VD. +1 line. +2 lines. +3 lines. +4 lines. -1 line. -2 lines. -3 lines. -4 lines.
2-0	LOFTS3	0 1 2 3 4 5 6 7	Line offset values of odd line and odd field (FID = 1). This bit is latched by VD. +1 line. +2 lines. +3 lines. +4 lines. -1 line. -2 lines. -3 lines. -4 lines.

### 6.1.16 SDRAM Address - High Register (STADRH)

The SDRAM address - high register (STADRH) is shown in [Figure 95](#) and described in [Table 60](#).

**Figure 95. SDRAM Address - High Register (STADRH)**


LEGEND: R/W = Read/Write; R = Read only; -n = value after reset

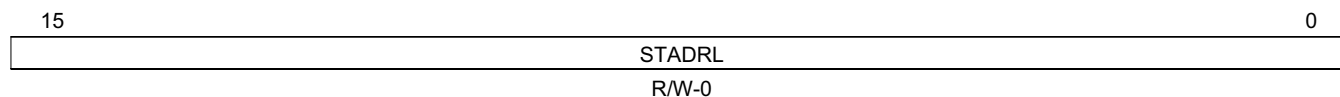
**Table 60. SDRAM Address - High Register (STADRH) Field Descriptions**

Bit	Field	Value	Description
15-7	Reserved	0	Reserved.
6-0	ADRH	0-7Fh	Upper 7 bits of the SDRAM starting address for CCDC output. The address is specified offset from the SDRAM base address in units of 32 bytes. This bit field is latched by VD.

### 6.1.17 SDRAM Address - Low Register (STADRL)

The SDRAM address - low register (STADRL) is shown in [Figure 96](#) and described in [Table 61](#).

**Figure 96. SDRAM Address - Low Register (STADRL)**



LEGEND: R/W = Read/Write; -n = value after reset

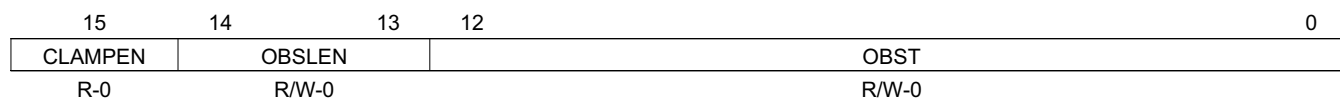
**Table 61. SDRAM Address - Low Register (STADRL) Field Descriptions**

Bit	Field	Value	Description
15-0	STADRL	0-FFFFh	Lower 16 bits of the SDRAM starting address for CCDC output. The address is specified offset from the SDRAM base address in units of 32 bytes. This bit field is latched by VD.

### 6.1.18 CCD Data Clamping Register (CLAMP)

The CCD data clamping register (CLAMP) is shown in [Figure 97](#) and described in [Table 62](#).

**Figure 97. CCD Data Clamping Register (CLAMP)**



LEGEND: R/W = Read/Write; R = Read only; -n = value after reset

**Table 62. CCD Data Clamping Register (CLAMP) Field Descriptions**

Bit	Field	Value	Description
15	CLAMPEN	0 1	Clamp enable. Enables clamping of CCD data based on the calculated average of Optical Black Samples. This should be disabled in YCbCr input modes. This bit is latched by VD. Disable. Enable.
14-13	OBSLEN	0 1 2 3	Optical black sample length. Number of Optical Black Sample pixels per line to include in the average calculation. 2 pixels. 4 pixels. 8 pixels. 16 pixels.
12-0	OBST	0-1FFFh	Start pixel of optical black samples. Start pixel position of Optical Black Samples, specified from the start of HD in pixel clocks.

### 6.1.19 DC Clamp Register (DCSUB)

The DC clamp register (DCSUB) is shown in [Figure 98](#) and described in [Table 63](#).

**Figure 98. DC Clamp Register (DCSUB)**

15	14	13	0
OBSLN		DCSUB	
R/W-0		R/W-0	

LEGEND: R/W = Read/Write; -n = value after reset

**Table 63. DC Clamp Register (DCSUB) Field Descriptions**

Bit	Field	Value	Description
15-14	OBSLN	0 1 2 3	Optical black sample lines. Number of Optical Black Sample lines to include in the average calculation. 2 lines. 4 lines. 8 lines. 16 lines.
13-0	DCSUB	0-3FFFh	DC level to subtract from CCD data. The DC value set here is subtracted from the CCD data when OBS clamping is disabled, CLAMPEN is 0.

### 6.1.20 CCD Color Pattern Register (COLPTN)

The CCD color pattern register (COLPTN) is shown in [Figure 99](#) and described in [Table 64](#).

**Figure 99. CCD Color Pattern Register (COLPTN)**

15	14	13	12	11	10	9	8	7	6	5	4	3	2	1	0
CPF1P0		CPF1P1		CPF1P2		CPF1P3		CPF0P0		CPF0P1		CPF0P2		CPF0P3	
R/W-0		R/W-0		R/W-0		R/W-0		R/W-0		R/W-0		R/W-0		R/W-0	

LEGEND: R/W = Read/Write; -n = value after reset

**Table 64. CCD Color Pattern Register (COLPTN) Field Descriptions**

Bit	Field	Value	Description
15-14	CPF1P0	0 1 2 3	Color pattern for pixel position 0 (Field 1). Mosaic: Pixel count = 0 at EVEN line. Stripe: Pixel count = 0. R/Ye. Gr/Cy. Gb/G. B/Mg.
13-12	CPF1P1	0 1 2 3	Color pattern for pixel position 1 (Field 1). Mosaic: Pixel count = 1 at EVEN line. Stripe: Pixel count = 1. R/Ye. Gr/Cy. Gb/G. B/Mg.

**Table 64. CCD Color Pattern Register (COLPTN) Field Descriptions (continued)**

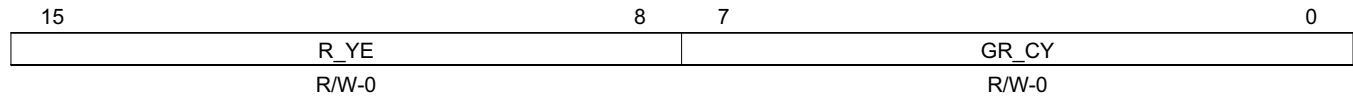
Bit	Field	Value	Description
11-10	CPF1P2	0 1 2 3	Color pattern for pixel position 2 (Field 1). Mosaic: Pixel count = 0 at ODD line. Stripe: Pixel count = 2. R/Ye. Gr/Cy. Gb/G. B/Mg.
9-8	CPF1P3	0 1 2 3	Color pattern for pixel position 3 (Field 1). Mosaic: Pixel count = 1 at ODD line. Stripe: Not applicable. R/Ye. Gr/Cy. Gb/G. B/Mg.
7-6	CPF0P0	0 1 2 3	Color pattern for pixel position 0 (Field 0). Mosaic: Pixel count = 0 at EVEN line. Stripe: Pixel count = 0. R/Ye. Gr/Cy. Gb/G. B/Mg.
5-4	CPF0P1	0 1 2 3	Color pattern for pixel position 1 (Field 0). Mosaic: Pixel count = 1 at EVEN line. Stripe: Pixel count = 1. R/Ye. Gr/Cy. Gb/G. B/Mg.
3-2	CPF0P2	0 1 2 3	Color pattern for pixel position 2 (Field 0). Mosaic: Pixel count = 0 at ODD line. Stripe: Pixel count = 2. R/Ye. Gr/Cy. Gb/G. B/Mg.
1-0	CPF0P3	0 1 2 3	Color pattern for pixel position 3 (Field 0). Mosaic: Pixel count = 1 at ODD line. Stripe: Not applicable. R/Ye. Gr/Cy. Gb/G. B/Mg.



### 6.1.21 Black Compensation #1 Register (BLKCOMP0)

The black compensation #1 register (BLKCOMP0) is shown in [Figure 100](#) and described in [Table 65](#).

**Figure 100. Black Compensation #1 Register (BLKCOMP0)**



LEGEND: R/W = Read/Write; -n = value after reset

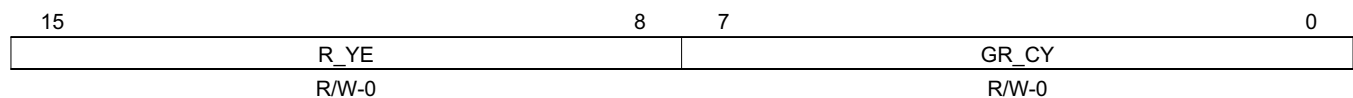
**Table 65. Black Compensation #1 Register (BLKCOMP0) Field Descriptions**

Bit	Field	Value	Description
15-8	R_YE	0-FFh	Black level compensation for R/Ye pixels (-128:+127) 2's complement, MSB is sign bit. This bit is latched by VD.
7-0	GR_CY	0-FFh	Black level compensation for Gr/Cy pixels (-128:+127) 2's complement, MSB is sign bit. This bit field is latched by VD.

### 6.1.22 Black Compensation #2 Register (BLKCOMP1)

The black compensation #2 register (BLKCOMP1) is shown in [Figure 101](#) and described in [Table 66](#).

**Figure 101. Black Compensation #2 Register (BLKCOMP1)**



LEGEND: R/W = Read/Write; -n = value after reset

**Table 66. Black Compensation #2 Register (BLKCOMP1) Field Descriptions**

Bit	Field	Value	Description
15-8	GB_G	0-FFh	Black level compensation for Gb/G pixels (-128:+127) 2's complement, MSB is sign bit. This bit is latched by VD.
7-0	B_MG	0-FFh	Black level compensation for B/Mg pixels (-128:+127) 2's complement, MSB is sign bit. This bit field is latched by VD.

### 6.1.23 CCD Median Filter Register (MEDFILT)

The CCD median filter register (MEDFILT) is shown in [Figure 102](#) and described in [Table 67](#).

**Figure 102. CCD Median Filter Register (MEDFILT)**

15	14	13	0
Reserved		MFTHR	
R-0		R/W-0	

LEGEND: R/W = Read/Write; R = Read only; -n = value after reset

**Table 67. CCD Median Filter Register (MEDFILT) Field Descriptions**

Bit	Field	Value	Description
15-14	Reserved	0	Reserved.
13-0	MFTHR	0-3FFFh	Threshold value for median filter.

### 6.1.24 CCD Gain Adjustment - R/Ye Register (RYEGAIN)

The CCD gain adjustment - R/Ye register (RYEGAIN) is shown in [Figure 103](#) and described in [Table 68](#).

**Figure 103. CCD Gain Adjustment - R/Ye Register (RYEGAIN)**

15	11	10	0
Reserved		GAIN	
R-0		R/W-256	

LEGEND: R/W = Read/Write; R = Read only; -n = value after reset

**Table 68. CCD Gain Adjustment - R/Ye Register (RYEGAIN) Field Descriptions**

Bit	Field	Value	Description
15-11	Reserved	0	Reserved.
10-0	GAIN	0-7FFh	Gain adjustment factor for CCD data. Value is U11Q8, i.e., decimal point between bits 8 and 7. Range: 0-7.9921875. This bit is latched by VD.

### 6.1.25 CCD Gain Adjustment - Gr/Cy Register (GRCYGAIN)

The CCD gain adjustment - Gr/Cy register (GRCYGAIN) is shown in [Figure 104](#) and described in [Table 69](#).

**Figure 104. CCD Gain Adjustment - Gr/Cy Register (GRCYGAIN)**

15	11	10	0
Reserved		GAIN	
R-0		R/W-256	

LEGEND: R/W = Read/Write; R = Read only; -n = value after reset

**Table 69. CCD Gain Adjustment - Gr/Cy Register (GRCYGAIN) Field Descriptions**

Bit	Field	Value	Description
15-11	Reserved	0	Reserved.
10-0	GAIN	0-7FFh	Gain adjustment factor for CCD data. Value is U11Q8, i.e., decimal point between bits 8 and 7. Range: 0-7.9921875. This bit is latched by VD.

### 6.1.26 CCD Gain Adjustment - Gb/G Register (GBGGAIN)

The CCD gain adjustment - Gb/G register (GBGGAIN) is shown in [Figure 105](#) and described in [Table 70](#).

**Figure 105. CCD gain adjustment - Gb/G register (GBGGAIN)**

15	11	10	0
Reserved		GAIN	
R-0		R/W-256	

LEGEND: R/W = Read/Write; R = Read only; -n = value after reset

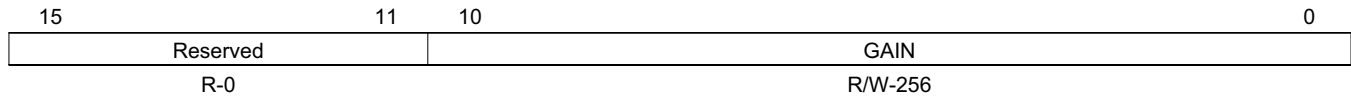
**Table 70. CCD gain adjustment - Gb/G register (GBGGAIN) Field Descriptions**

Bit	Field	Value	Description
15-11	Reserved	0	Reserved.
10-0	GAIN	0-7FFh	Gain adjustment factor for CCD data. Value is U11Q8, i.e., decimal point between bits 8 and 7. Range: 0-7.9921875. This bit is latched by VD.

### 6.1.27 CCD Gain Adjustment - B/Mg Register (BMGGAIN)

The CCD gain adjustment - B/Mg register (BMGGAIN) is shown in [Figure 106](#) and described in [Table 71](#).

**Figure 106. CCD Gain Adjustment - B/Mg Register (BMGGAIN)**



LEGEND: R/W = Read/Write; R = Read only; -n = value after reset

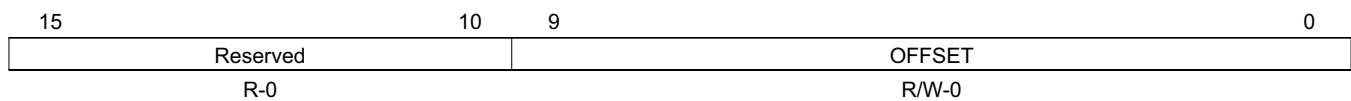
**Table 71. CCD Gain Adjustment - B/Mg Register (BMGGAIN) Field Descriptions**

Bit	Field	Value	Description
15-11	Reserved	0	Reserved.
10-0	GAIN	0-7FFh	Gain adjustment factor for CCD data. Value is U11Q8, i.e., decimal point between bits 8 and 7. Range: 0-7.9921875. This bit is latched by VD.

### 6.1.28 CCD Offset Adjustment Register (OFFSET)

The CCD offset adjustment register (OFFSET) is shown in [Figure 107](#) and described in [Table 72](#).

**Figure 107. CCD Offset Adjustment Register (OFFSET)**



LEGEND: R/W = Read/Write; R = Read only; -n = value after reset

**Table 72. CCD Offset Adjustment Register (OFFSET) Field Descriptions**

Bit	Field	Value	Description
15-10	Reserved	0	Reserved.
9-0	OFFSET	0-3FFh	Offset adjustment after gain adjustment. Value is added to data after gain (0-1023). This bit is latched by VD.

### 6.1.29 Output Clipping Value Register (OUTCLIP)

The output clipping value register (OUTCLIP) is shown in [Figure 108](#) and described in [Table 73](#).

**Figure 108. Output Clipping Value Register (OUTCLIP)**

15	14	13	0
Reserved		OCLIP	
R-0		R/W-16383	

LEGEND: R/W = Read/Write; R = Read only; -n = value after reset

**Table 73. Output Clipping Value Register (OUTCLIP) Field Descriptions**

Bit	Field	Value	Description
15-14	Reserved	0	Reserved.
13-0	OCLIP	0-3FFFh	Output clipping value after gain and offset.

### 6.1.30 VD Interrupt #0 Register (VDINT0)

The VD interrupt #0 register (VDINT0) is shown in [Figure 109](#) and described in [Table 74](#).

**Figure 109. VD Interrupt #0 Register (VDINT0)**

15	14	0
Reserved		VDINT0
R-0		R/W-0

LEGEND: R/W = Read/Write; R = Read only; -n = value after reset

**Table 74. VD Interrupt #0 Register (VDINT0) Field Descriptions**

Bit	Field	Value	Description
15	Reserved	0	Reserved.
14-0	VDINT0	0-7FFFh	VD0 Interrupt Timing. Specify VDINT0 in units of horizontal lines from the start of VD pulse.

### 6.1.31 VD Interrupt #1 Register (VDINT1)

The VD interrupt #1 register (VDINT1) is shown in [Figure 110](#) and described in [Table 75](#).

**Figure 110. VD Interrupt #1 Register (VDINT1)**

15	14	0
Reserved		VDINT1
R-0		R/W-0

LEGEND: R/W = Read/Write; R = Read only; -n = value after reset

**Table 75. VD Interrupt #1 Register (VDINT1) Field Descriptions**

Bit	Field	Value	Description
15	Reserved	0	Reserved.
14-0	VDINT1	0-7FFFh	VD1 Interrupt Timing. Specify VDINT1 in units of horizontal lines from the start of VD pulse.

### 6.1.32 Gamma Correction Settings Register (GAMMAWD)

The gamma correction settings register (GAMMAWD) is shown in [Figure 111](#) and described in [Table 76](#).

**Figure 111. Gamma Correction Settings Register (GAMMAWD)**

15	12	11	10	9	8	7	6	5	4	2	1	0
Reserved		MFIL1		MFIL2		Reserved		CFAP	GWDI	Reserved		CCDTBL
R-0		R/W-0		R/W-0		R-0		R/W-0	R/W-0	R-0		R/W-0

LEGEND: R/W = Read/Write; R = Read only; -n = value after reset

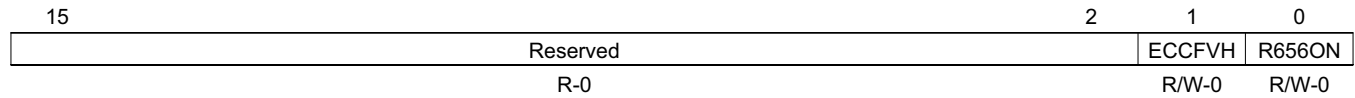
**Table 76. Gamma Correction Settings Register (GAMMAWD) Field Descriptions**

Bit	Field	Value	Description
15-12	Reserved	0	Reserved
11-10	MFIL1	0 1 2 3	Median filter mode for IPIPE. This bit is latched by VD. 0 No Median filter. 1 Average filter. 2 Median filter. 3 Reserved.
9-8	MFIL2	0 1 2 3	Median Filter for SDRAM capture. This bit is latched by VD. 0 No Median filter. 1 Average filter. 2 Median filter. 3 Reserved.
7-6	Reserved	0	Reserved.
5	CFAP	0 1	CFA Pattern. This bit is latched by VD. 0 Mosaic. 1 Stripe.
4-2	GWDI	0 1 2 3 4 5-7	Gamma Width Input (For A-LAW table & H3A port). This bit is latched by VD. 0 Bits 13-4. 1 Bits 12-3. 2 Bits 11-2. 3 Bits 10-1. 4 Bits 9-0. 5-7 Reserved.
1	Reserved	0	Reserved.
0	CCDTBL	0 1	Apply Gamma (A-LAW) to CCDC data saved to SDRAM. This bit is latched by VD. 0 Disable. 1 Enable.

### 6.1.33 REC656 Control Register (REC656IF)

The REC656 control register (REC656IF) is shown in [Figure 112](#) and described in [Table 77](#).

**Figure 112. REC656 Control Register (REC656IF)**



LEGEND: R/W = Read/Write; -n = value after reset

**Table 77. REC656 Control Register (REC656IF) Field Descriptions**

Bit	Field	Value	Description
15-2	Reserved	0	Reserved.
1	ECCFVH	0	FVH error correction enable. Disable.
		1	Enable.
0	R656ON	0	REC656 interface enable. Disable.
		1	Enable.

### 6.1.34 CCD Configuration Register (CCDCFG)

The CCD configuration register (CCDCFG) is shown in [Figure 113](#) and described in [Table 78](#).

**Figure 113. CCD Configuration Register (CCDCFG)**

15	14	13	12	11	10	9	8
VDLC	Reserved	MSBINVI	BSWD	Y8POS	EXTRG	TRGSEL	WENLOG
R/W-0	R-0	R/W-0	R/W-0	R/W-0	R/W-0	R/W-0	R/W-0
7	6	5	4	3	Reserved		0
Reserved	FIDMD	BW656	YCINSWP	Reserved			
R-0	R/W-0	R/W-0	R/W-0	R-0			

LEGEND: R/W = Read/Write; R = Read only; -n = value after reset

**Table 78. CCD Configuration Register (CCDCFG) Field Descriptions**

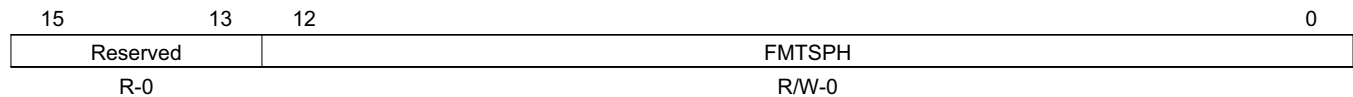
Bit	Field	Value	Description
15	VDLC	0 1	Enable synchronizing function registers on VSYNC. Latched on VSYNC. Not latched on VSYNC.
14	Reserved		Reserved.
13	MSBINVI	0 1	MSB of Chroma input signal stored to SDRAM inverted. Normal. MSB inverted.
12	BSWD	0 1	Byte swap data stored to SDRAM. Normal. Swap Bytes.
11	Y8POS	0 1	Location of Y signal when YCbCr 8bit data is input. Even pixel. Odd pixel.
10	EXTRG	0 1	External trigger. Disable. Enable.
9	TRGSEL	0 1	Signal that initializes SDRAM address when EXTRG = 1. WEN bit (SYNCEN register). FID input port.
8	WENLOG	0 1	Specifies CCD valid area. Internal valid and WEN signals are ANDed logically. Internal valid and WEN signals are ORed logically.
7	Reserved	0	Reserved.
6	FIDMD	0 1	Setting of FID detection function. FID signal is latched at the VSYNC timing. FID signal is not latched.
5	BW656	0 1	The data width in REC656 input mode. 8-bits. 10-bits.
4	YCINSWP	0 1	Y input (YIN[7:0]) and C input (CIN[7:0]) are swapped. (NO_YCIN_SWAP) YIN[7:0] = Y signal / CIN[7:0] = C signal. (YCIN_SWAP) YIN[7:0] = C signal / CIN[7:0] = Y signal.
3-0	Reserved	0	Reserved.



### 6.1.35 Start Pixel Horizontal Register (FMTSPH)

The start pixel horizontal register (FMTSPH) is shown in [Figure 114](#) and described in [Table 79](#).

**Figure 114. Start Pixel Horizontal Register (FMTSPH)**



LEGEND: R/W = Read/Write; R = Read only; -n = value after reset

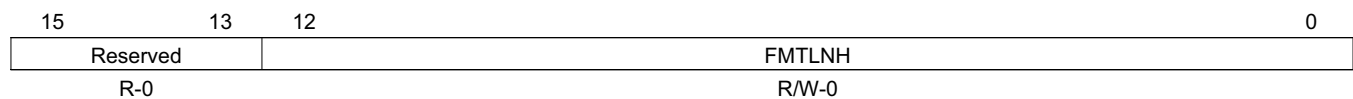
**Table 79. Start Pixel Horizontal Register (FMTSPH) Field Descriptions**

Bit	Field	Value	Description
15-13	Reserved	0	Reserved.
12-0	FMTSPH	0-1FFFh	Start pixel horizontal.

### 6.1.36 Number Of Pixels Register (FMTLNH)

The number of pixels register (FMTLNH) is shown in [Figure 115](#) and described in [Table 80](#).

**Figure 115. Number Of Pixels Register (FMTLNH)**



LEGEND: R/W = Read/Write; R = Read only; -n = value after reset

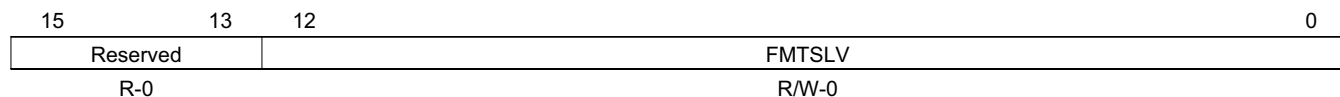
**Table 80. Number Of Pixels Register (FMTLNH) Field Descriptions**

Bit	Field	Value	Description
15-13	Reserved	0	Reserved.
12-0	FMTLNH	0-1FFFh	Number of pixels in horizontal. Number of pixels = FMTLNH + 1.

### 6.1.37 Start Line Vertical Register (FMTSLV)

The start line vertical register (FMTSLV) is shown in [Figure 116](#) and described in [Table 81](#).

**Figure 116. Start Line Vertical Register (FMTSLV)**



LEGEND: R/W = Read/Write; R = Read only; -n = value after reset

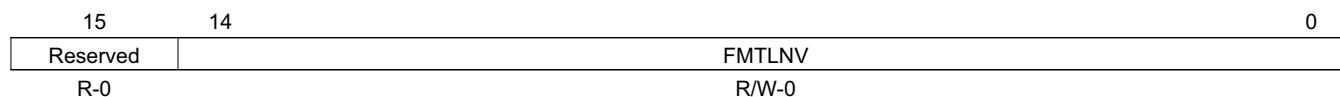
**Table 81. Start Line Vertical Register (FMTSLV) Field Descriptions**

Bit	Field	Value	Description
15-13	Reserved	0	Reserved.
12-0	FMTSLV	0-1FFFh	Start line vertical.

### 6.1.38 Number of Lines Register (FMTLNV)

The number of lines register (FMTLNV) is shown in [Figure 117](#) and described in [Table 82](#).

**Figure 117. Number of Lines Register (FMTLNV)**



LEGEND: R/W = Read/Write; R = Read only; -n = value after reset

**Table 82. Number of Lines Register (FMTLNV) Field Descriptions**

Bit	Field	Value	Description
15	Reserved	0	Reserved.
14-0	FMTLNV	0-7FFFh	Number of lines in vertical. Number of lines = FMTLNV + 1.

### 6.1.39 Lens Shading Correction Configuration 1 Register (LSCCFG1)

The lens shading correction configuration 1 register (LSCCFG1) is shown in [Figure 118](#) and described in [Table 83](#).

**Figure 118. Lens Shading Correction Configuration 1 Register (LSCCFG1)**

15	6	5	4	3	1	0
Reserved		GFMODE		Reserved		LSCEN
R-0		R/W-0		R-0		R/W-0

LEGEND: R/W = Read/Write; R = Read only; -n = value after reset

**Table 83. Lens Shading Correction Configuration 1 Register (LSCCFG1) Field Descriptions**

Bit	Field	Value	Description
15-6	Reserved	0	Reserved.
11	GFMODE	0	Gain Factor Mode. U8Q8 + 1 with Interpolation.
		1	U16Q14 with Interpolation.
		2	Reserved.
		3	U16Q14 without Interpolation.
			Gain factor range is: U8Q8 + 1: $1 \leq \text{Gain Factor} \leq 1 + 255/256$ U16Q14: $0 \leq \text{Gain Factor} \leq 3 + 16383/16384$
		0	(U8Q8_interpolation) U8Q8 with interpolation.
		1	(U16Q14_interpolation) U16Q14 with interpolation.
		2	Reserved.
		3	(U16Q14) U16Q14 without interpolation.
3-1	Reserved	0	Reserved.
0	LSCEN		Lens shading correction enable. This bit field is latched by VD.
		0	Disable.
		1	Enable.

### 6.1.40 Lens Shading Correction Configuration 2 Register (LSCCFG2)

The lens shading correction configuration 2 register (LSCCFG2) is shown in [Figure 119](#) and described in [Table 84](#).

**Figure 119. Lens Shading Correction Configuration 2 Register (LSCCFG2)**

15	14	13	12	11	10	9	8
GFTSEL_OPOL		GFTSEL_EPOL		GFTSEL_OPEL		GFTSEL_EPEL	
R/W-0		R/W-0		R/W-0		R/W-0	
7	4			3	1	0	
GFTINV				GFTSF			Reserved
R/W-0				R/W-7			R-0

LEGEND: R/W = Read/Write; R = Read only; -n = value after reset

**Table 84. Lens Shading Correction Configuration 2 Register (LSCCFG2) Field Descriptions**

Bit	Field	Value	Description
15-14	GFTSEL_OPOL	0 1 2	Gain factor table selection for odd pixel, odd line. Table 1. Table 2. Table 3.
13-12	GFTSEL_EPOL	0-3	Gain factor table selection for even pixel, odd line.
11-10	GFTSEL_OPEL	0-3	Gain factor table selection for odd pixel, even line.
9-8	GFTSEL_EPEL	0-3	Gain factor table selection for even pixel, even line.
7-4	GFTINV	0-Fh	Gain factor table interval (n).
3-1	GFTSF	0-7	Gain factor table scaling factor (m). LUT address = $(m + 9)/16 \times 2^{-n} \times \text{SQRDST}$ $(\text{SQRDST} = kh \times (H - H_0)^2 + kv \times (V - V_0)^2)$
0	Reserved	0	Reserved.

### 6.1.41 Lens Shading Correction - Center Position (H0) Register (LSCH0)

The lens shading correction - center position (H0) register (LSCH0) is shown in [Figure 120](#) and described in [Table 85](#).

**Figure 120. Lens Shading Correction - Center Position (H0) Register (LSCH0)**

15	14	13	0
LSCCSW		LSCH0	
R/W-0		R/W-0	

LEGEND: R/W = Read/Write; -n = value after reset

**Table 85. Lens Shading Correction - Center Position (H0) Register (LSCH0) Field Descriptions**

Bit	Field	Value	Description
15-14	LSCCSW	0 1 2	Color channel switch for shading factors (H 0 , V 0 , k h , k v) configuration.  By switching LSCCSW, you can configure H0, V0, kh, kv for each color channel. Values set to LSCH0, LSCV0, LSCKHL, LSCKHR, LSCKVU, and LSCKVL while LSCCSW is "00", are valid for the color channel which uses Gain Factor Table 1.  Table 1. Table 2. Table 3.
13-0	LSCH0	0-3FFFh	Lens center position (H0: H direction). Range: 0-16383

### 6.1.42 Lens Shading Correction - Center Position (V0) Register (LSCV0)

The lens shading correction - center position (V0) register (LSCV0) is shown in [Figure 121](#) and described in [Table 86](#).

**Figure 121. Lens Shading Correction - Center Position (V0) Register (LSCV0)**

15	14	13	0
Reserved		LSCV0	
R-0		R/W-0	

LEGEND: R/W = Read/Write; R = Read only; -n = value after reset

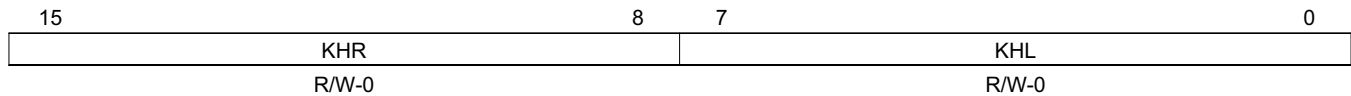
**Table 86. Lens Shading Correction - Center Position (V0) Register (LSCV0) Field Descriptions**

Bit	Field	Value	Description
15-14	Reserved	0	Reserved.
13-0	LSCV0	0-3FFFh	Lens center position (V0: V direction). Range: 0-16383

### 6.1.43 Lens Shading Correction - Horizontal Coefficients Register (LSCKH)

The lens shading correction - horizontal coefficients register (LSCKH) is shown in [Figure 122](#) and described in [Table 87](#).

**Figure 122. Lens Shading Correction - Horizontal Coefficients Register (LSCKH)**



LEGEND: R/W = Read/Write; -n = value after reset

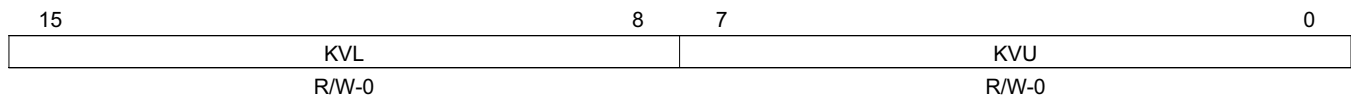
**Table 87. Lens Shading Correction - Horizontal Coefficients Register (LSCKH) Field Descriptions**

Bit	Field	Value	Description
15-8	KHR	0-FFh	Horizontal-right coefficient (Khr). Khr is selected when (H > H0). Khr is U8Q7.
7-0	KHL	0-FFh	Horizontal-left coefficient (Khl). Khl is selected when (H < H0). Khl is U8Q7.

### 6.1.44 Lens Shading Correction - Vertical Coefficients Register (LSCKV)

The lens shading correction - vertical coefficients register (LSCKV) is shown in [Figure 123](#) and described in [Table 88](#).

**Figure 123. Lens Shading Correction - Vertical Coefficients Register (LSCKV)**



LEGEND: R/W = Read/Write; -n = value after reset

**Table 88. Lens Shading Correction - Vertical Coefficients Register (LSCKV) Field Descriptions**

Bit	Field	Value	Description
15-8	KVL	0-FFh	Vertical-lower coefficient (Kvl). Kvl is selected when (V > V0). Kvl is U8Q7.
7-0	KVU	0-FFh	Vertical-upper coefficient (Kvu). Kvu is selected when (V < V0). Kvu is U8Q7.

### 6.1.45 Lens Shading Correction - Memory Control Register (LSCMEMCTL)

The lens shading correction - memory control register (LSCMEMCTL) is shown in [Figure 124](#) and described in [Table 89](#).

**Figure 124. Lens Shading Correction - Memory Control Register (LSCMEMCTL)**

15	5	4	3	2	1	0
Reserved		LSCMBSY	LSCMRD	LSCMARST	LSCMSL	
R-0		R-0	R/W-0	R/W-0	R/W-0	

LEGEND: R/W = Read/Write; R = Read only; -n = value after reset

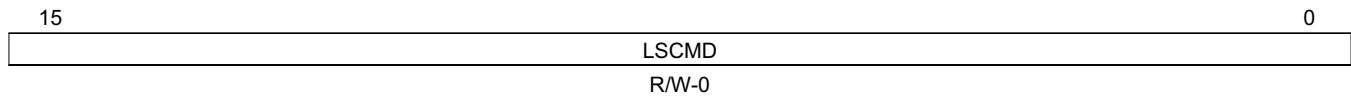
**Table 89. Lens Shading Correction - Memory Control Register (LSCMEMCTL) Field Descriptions**

Bit	Field	Value	Description
15-5	Reserved	0	Reserved.
4	LSCMBSY	0 1	Memory access busy flag. Set during memory configuration, when table updates are not allowed. Not busy. Busy.
3	LSCMRD	0 1	Memory read (for debug). Set LSCMRD and write any data to LSCMD. After LSCMBSY becomes 0, You'll be able to read memory data from LSCMQ. If LSCMARST is set, data of the address offset 0 can be read. Memory write. Memory read.
2	LSCMARST	0 1	Memory address reset. Write the gain factors for LUT address 0 and 1 to LSCMD with LSCMARST set. LSCMARST is automatically cleared if any of the data is written to LSCMD. Writing gain factors with LSCMARST cleared stores the data to the next half-word address. Increment the gain table address. Clear the gain table address to offset 0.
1-0	LSCMSL	0 1 2 3	Memory selection. Table 1. Table 2. Table 3. Reserved.

### 6.1.46 Lens Shading Correction - Memory Write Data Register (LSCMEMD)

The lens shading correction memory Write data register (LSCMEMD) is shown in [Figure 125](#) and described in [Table 90](#).

**Figure 125. Lens Shading Correction - Memory Write Data Register (LSCMEMD)**



LEGEND: R/W = Read/Write; -n = value after reset

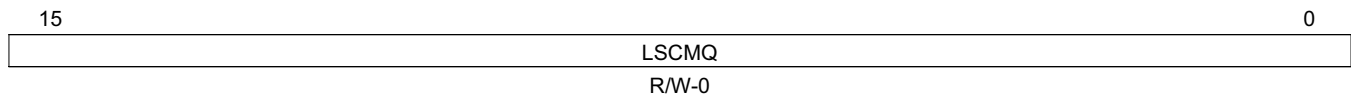
**Table 90. Lens Shading Correction - Memory Write Data Register (LSCMEMD) Field Descriptions**

Bit	Field	Value	Description
15-0	LSCMD	0-FFFFh	Memory write data. In case Gain Factor is U8Q8+1 (LSCGFMD = 00), a series of 2 Gain Factors can be stored at a table at once by writing 16bit data to LSCMD. U8Q8 + 1: Gain Factor(2N+1) & Gain Factor(2N) U16Q14: Gain Factor(N)

### 6.1.47 Lens Shading Correction - Memory Read Data Register (LSCMEMQ)

The lens shading correction - memory read data register (LSCMEMQ) is shown in [Figure 126](#) and described in [Table 91](#).

**Figure 126. Lens Shading Correction - Memory Read Data Register (LSCMEMQ)**



LEGEND: R/W = Read/Write; -n = value after reset

**Table 91. Lens Shading Correction - Memory Read Data Register (LSCMEMQ) Field Descriptions**

Bit	Field	Value	Description
15-0	LSCMQ	0-FFFFh	Memory read data (for debug purpose). Memory data can be read out from LSCMQ.



### 6.1.48 Defect Correction - Control Register (DFCCTL)

The defect correction - control register (DFCCTL) is shown in [Figure 127](#) and described in [Table 92](#).

**Figure 127. Defect Correction - Control Register (DFCCTL)**

15	11	10	8	7	6	5	4	3	1	0
Reserved		VDFLSFT	VDFCUDA	VDFCSL	VDFCEN	Reserved		Reserved		GDFCEN
R-0		R/W-0	R/W-0	R/W-0	R/W-0	R/W-0		R-0		R/W-0

LEGEND: R/W = Read/Write; R = Read only; -n = value after reset

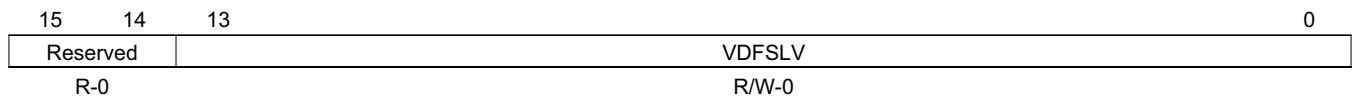
**Table 92. Defect Correction - Control Register (DFCCTL) Field Descriptions**

Bit	Field	Value	Description
15-11	Reserved	0	Reserved.
10-8	VDFLSFT	0-7h	Vertical line defect level shift value. Defect Level (value to be subtracted from the data) is 8bit width, but can be up-shifted up to 6bits by VDFLSFT. Left shift value = VDFLSFT (Range: 0-6) Setting 7 to VDFLSFT is not allowed.
7	VDFCUDA	0 1	Vertical line defect correction upper pixels disable. 0 The whole line is corrected. 1 Pixels upper than the defect are not corrected.
6-5	VDFCSL	0 1 2 3	Vertical line defect correction mode select. 0 (NORMAL) Defect level subtraction. Just fed through if data are saturating. 1 (HORZINTERPOLIFSAT) Defect level subtraction. Horizontal interpolation $((I - 2) + (I + 2))/2$ if data are saturating. 2 (HORZINTERPOL) Horizontal interpolation $((I - 2) + (I + 2))/2$ . 3 Reserved.
4	VDFCEN	0 1	Vertical line defect correction enable. This bit field is latched by VD. 0 Off. 1 On.
3-1	Reserved	0	Reserved.
0	GDFCEN	0 1	General defect correction enable. This bit field is latched by VD. 0 Off. 1 On.

### 6.1.49 Defect Correction - Vertical Saturation Level Register (DFCVSAT)

The defect correction - vertical saturation level register (DFCVSAT) is shown in [Figure 128](#) and described in [Table 93](#).

**Figure 128. Defect Correction - Vertical Saturation Level Register (DFCVSAT)**



LEGEND: R/W = Read/Write; R = Read only; -n = value after reset

**Table 93. Defect Correction - Vertical Saturation Level Register (DFCVSAT) Field Descriptions**

Bit	Field	Value	Description
15-14	Reserved	0	Reserved.
13-0	VDFSLV	0-3FFFh	Vertical line defect correction saturation level. VDFSLV is U14 (Range: 0-16383).

### 6.1.50 Defect Correction - Memory Control Register (DFCMEMCTL)

The defect correction - memory control register (DFCMEMCTL) is shown in [Figure 129](#) and described in [Table 94](#).

**Figure 129. Defect Correction - Memory Control Register (DFCMEMCTL)**

15	5	4	3	2	1	0
Reserved	DFCMCLR	Reserved	DFCMARST	DFCMRD	DFCMWR	
R-0	R/W-0	R-0	R/W-0	R/W-0	R/W-0	R/W-0

LEGEND: R/W = Read/Write; R = Read only; -n = value after reset

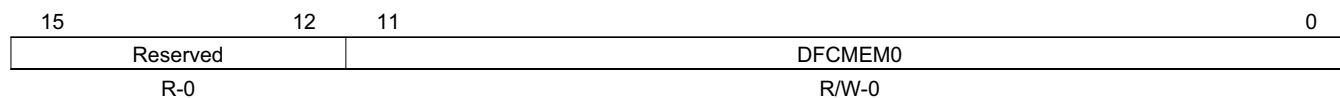
**Table 94. Defect Correction - Memory Control Register (DFCMEMCTL) Field Descriptions**

Bit	Field	Value	Description
15-5	Reserved	0	Reserved.
4	DFCMCLR	0	Memory clear. Writing 1 to this bit clears the memory contents to all zero. It will be automatically cleared to 0 when the memory clear is completed.
		0	Memory clear complete.
		1	Clear memory.
3	Reserved	0	Reserved.
2	DFCMARST		Memory address reset. Setting DFCMWR or DFCMRD with LSCMARST set starts memory access to address offset 0. DFCMARST is automatically cleared if data transfer completes. Setting DFCMWR or DFCMRD with LSCMARST cleared starts memory access to the next address.
		0	Increment the memory address.
		1	Clear the memory address to offset 0.
1	DFCMRD		Memory read (for debug). Writing 1 to this bit starts reading from the memory. It will be automatically cleared when the data transfer is completed, and the data can be read from DFCMEM4_0.
		0	Memory read complete.
		1	Memory read.
0	DFCMWR		Memory write. Writing 1 to this bit starts writing to the memory. It will be automatically cleared when the data transfer is completed. DFCMEM4_0 should be set prior to the memory access.
		0	Memory write complete.
		1	Memory write.

### 6.1.51 Defect Correction - Set V Position Register (DFCMEM0)

The defect correction - set V position register (DFCMEM0) is shown in [Figure 130](#) and described in [Table 95](#).

**Figure 130. Defect Correction - Set V Position Register (DFCMEM0)**



LEGEND: R/W = Read/Write; R = Read only; -n = value after reset

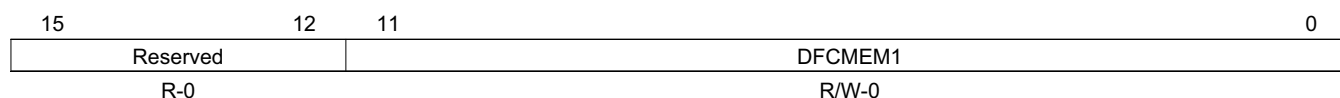
**Table 95. Defect Correction - Set V Position Register (DFCMEM0) Field Descriptions**

Bit	Field	Value	Description
15-12	Reserved	0	Reserved.
11-0	DFCMEM0	0-1	Memory 0. Set V position of the defects.

### 6.1.52 Defect Correction - Set H Position Register (DFCMEM1)

The defect correction - set H position register (DFCMEM1) is shown in [Figure 131](#) and described in [Table 96](#).

**Figure 131. Defect Correction - Set H Position Register (DFCMEM1)**



LEGEND: R/W = Read/Write; R = Read only; -n = value after reset

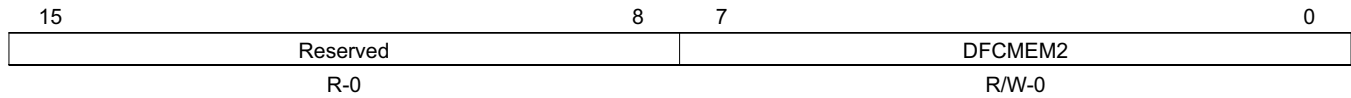
**Table 96. Defect Correction - Set H Position Register (DFCMEM1) Field Descriptions**

Bit	Field	Value	Description
15-12	Reserved	0	Reserved.
11-0	DFCMEM1	0-1	Memory 1. Set H position of the defects.

### 6.1.53 Defect Correction - Set SUB1 Register (DFCMEM2)

The defect correction - set SUB1 register (DFCMEM2) is shown in [Figure 132](#) and described in [Table 97](#).

**Figure 132. Defect Correction - Set SUB1 Register (DFCMEM2)**



LEGEND: R/W = Read/Write; R = Read only; -n = value after reset

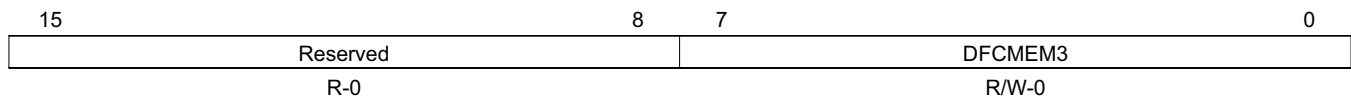
**Table 97. Defect Correction - Set SUB1 Register (DFCMEM2) Field Descriptions**

Bit	Field	Value	Description
15-8	Reserved	0	Reserved.
7-0	DFCMEM2	0-FFh	Memory 2. Set SUB1: Defect level of the Vertical line defect position ( $V = V_{\text{defect}}$ ). DFCMEM2 can be up shifted according to VDFLSFT, and subtracted from the data for Vertical line defect correction.

### 6.1.54 Defect Correction - Set SUB2 Register (DFCMEM3)

The defect correction - set SUB2 register (DFCMEM3) is shown in [Figure 133](#) and described in [Table 98](#).

**Figure 133. Defect Correction - Set SUB2 Register (DFCMEM3)**



LEGEND: R/W = Read/Write; R = Read only; -n = value after reset

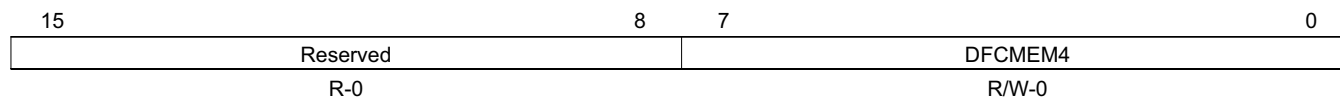
**Table 98. Defect Correction - Set SUB2 Register (DFCMEM3) Field Descriptions**

Bit	Field	Value	Description
15-8	Reserved	0	Reserved.
7-0	DFCMEM3	0-FFh	Memory 3. Set SUB2: Defect level of the pixels upper than the Vertical line defect ( $V < V_{\text{defect}}$ ). DFCMEM3 can be up shifted according to VDFLSFT, and subtracted from the data for Vertical line defect correction.

### 6.1.55 Defect Correction - Set SUB3 Register (DFCMEM4)

The defect correction - set SUB3 register (DFCMEM4) is shown in [Figure 134](#) and described in [Table 99](#).

**Figure 134. Defect Correction - Set SUB3 Register (DFCMEM4)**



LEGEND: R/W = Read/Write; R = Read only; -n = value after reset

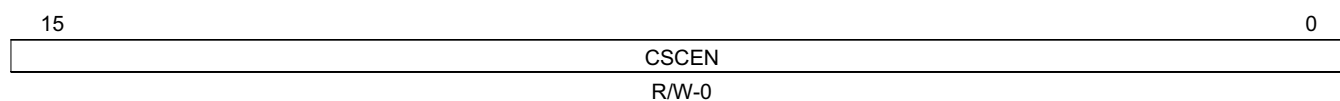
**Table 99. Defect Correction - Set SUB3 Register (DFCMEM4) Field Descriptions**

Bit	Field	Value	Description
15-8	Reserved	0	Reserved.
7-0	DFCMEM4	0-FFh	Memory 4 Set SUB3: Defect level of the pixels lower than the Vertical line defect ( $V > V_{defect}$ ). DFCMEM4 can be up shifted according to VDFLSFT, and subtracted from the data for Vertical line defect correction.

### 6.1.56 Color Space Converter Enable Register (CSCCTL)

The color space converter enable register (CSCCTL) is shown in [Figure 135](#) and described in [Table 100](#).

**Figure 135. Color Space Converter Enable Register (CSCCTL)**



LEGEND: R/W = Read/Write; -n = value after reset

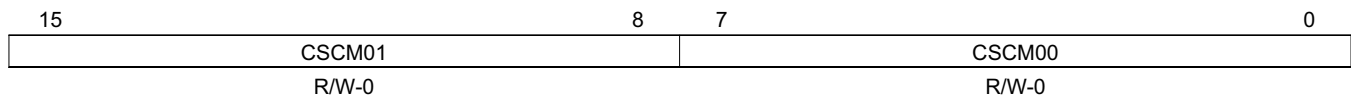
**Table 100. Color Space Converter Enable Register (CSCCTL) Field Descriptions**

Bit	Field	Value	Description
15-0	CSCEN	0	CSC enable. (DISABLE) disable.
		1	(ENABLE) enable.

### 6.1.57 Color Space Converter - Coefficients #0 Register (CSCM0)

The color space converter - coefficients #0 register (CSCM0) is shown in [Figure 136](#) and described in [Table 101](#).

**Figure 136. Color Space Converter - Coefficients #0 Register (CSCM0)**



LEGEND: R/W = Read/Write; -n = value after reset

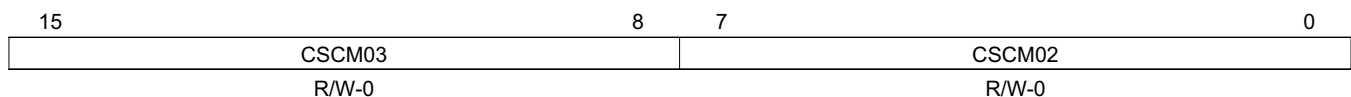
**Table 101. Color Space Converter - Coefficients #0 Register (CSCM0) Field Descriptions**

Bit	Field	Value	Description
15-8	CSCM01	0-FFh	Color space conversion coefficient value M01. This value is S8Q5.
7-0	CSCM00	0-FFh	Color space conversion coefficient value M00. This value is S8Q5.

### 6.1.58 Color Space Converter - Coefficients #1 Register (CSCM1)

The color space converter - coefficients #1 register (CSCM1) is shown in [Figure 137](#) and described in [Table 102](#).

**Figure 137. Color Space Converter - Coefficients #1 Register (CSCM1)**



LEGEND: R/W = Read/Write; -n = value after reset

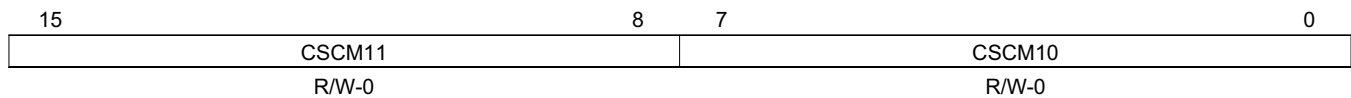
**Table 102. Color Space Converter - Coefficients #1 Register (CSCM1P) Field Descriptions**

Bit	Field	Value	Description
15-8	CSCM03	0-FFh	Color space conversion coefficient value M03. This value is S8Q5.
7-0	CSCM02	0-FFh	Color space conversion coefficient value M02. This value is S8Q5.

### 6.1.59 Color Space Converter - Coefficients #2 Register (CSCM2)

The color space converter - coefficients #2 register (CSCM2) is shown in [Figure 138](#) and described in [Table 103](#).

**Figure 138. Color Space Converter - Coefficients #2 Register (CSCM2)**



LEGEND: R/W = Read/Write; -n = value after reset

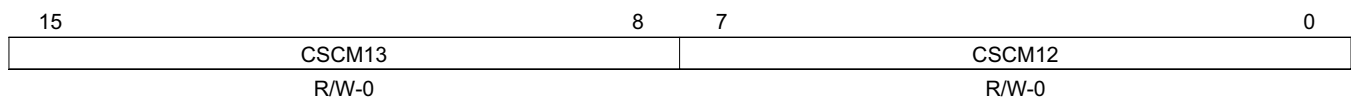
**Table 103. Color Space Converter - Coefficients #2 Register (CSCM2) Field Descriptions**

Bit	Field	Value	Description
15-8	CSCM11	0-FFh	Color space conversion coefficient value M11. This value is S8Q5.
7-0	CSCM10	0-FFh	Color space conversion coefficient value M10. This value is S8Q5.

### 6.1.60 Color Space Converter - Coefficients #3 Register (CSCM3)

The color space converter - coefficients #3 register (CSCM3) is shown in [Figure 139](#) and described in [Table 104](#).

**Figure 139. Color Space Converter - Coefficients #3 Register (CSCM3)**



LEGEND: R/W = Read/Write; -n = value after reset

**Table 104. Color Space Converter - Coefficients #3 Register (CSCM3) Field Descriptions**

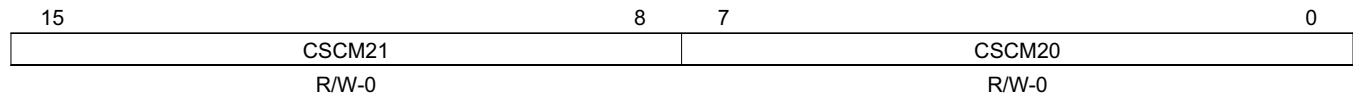
Bit	Field	Value	Description
15-8	CSCM13	0-FFh	Color space conversion coefficient value M13. This value is S8Q5.
7-0	CSCM12	0-FFh	Color space conversion coefficient value M12. This value is S8Q5.



### 6.1.61 Color Space Converter - Coefficients #4 Register (CSCM4)

The color space converter - coefficients #4 register (CSCM4) is shown in [Figure 140](#) and described in [Table 105](#).

**Figure 140. Color Space Converter - Coefficients #4 Register (CSCM4)**



LEGEND: R/W = Read/Write; -n = value after reset

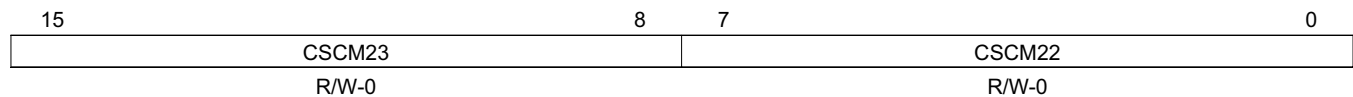
**Table 105. Color Space Converter - Coefficients #4 Register (CSCM4) Field Descriptions**

Bit	Field	Value	Description
15-8	CSCM21	0-FFh	Color space conversion coefficient value M21. This value is S8Q5.
7-0	CSCM20	0-FFh	Color space conversion coefficient value M20. This value is S8Q5.

### 6.1.62 Color Space Converter - Coefficients #5 Register (CSCM5)

The color space converter - coefficients #5 register (CSCM5) is shown in [Figure 141](#) and described in [Table 106](#).

**Figure 141. Color Space Converter - Coefficients #5 Register (CSCM5)**



LEGEND: R/W = Read/Write; -n = value after reset

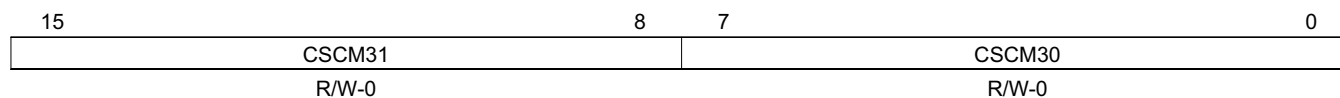
**Table 106. Color Space Converter - Coefficients #5 Register (CSCM5) Field Descriptions**

Bit	Field	Value	Description
15-8	CSCM23	0-FFh	Color space conversion coefficient value M23. This value is S8Q5.
7-0	CSCM22	0-FFh	Color space conversion coefficient value M22. This value is S8Q5.

### 6.1.63 Color Space Converter - Coefficients #6 Register (CSCM6)

The color space converter - coefficients #6 register (CSCM6) is shown in [Figure 142](#) and described in [Table 107](#).

**Figure 142. Color Space Converter - Coefficients #6 Register (CSCM6)**



LEGEND: R/W = Read/Write; -n = value after reset

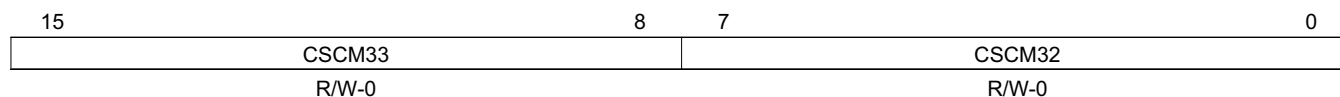
**Table 107. Color Space Converter - Coefficients #6 Register (CSCM6) Field Descriptions**

Bit	Field	Value	Description
15-8	CSCM31	0-FFh	Color space conversion coefficient value M31. This value is S8Q5.
7-0	CSCM30	0-FFh	Color space conversion coefficient value M30. This value is S8Q5.

### 6.1.64 Color Space Converter - Coefficients #7 Register (CSCM7)

The color space converter coefficients #7 register (CSCM7) is shown in [Figure 143](#) and described in [Table 108](#).

**Figure 143. Color Space Converter - Coefficients #7 Register (CSCM7)**



LEGEND: R/W = Read/Write; -n = value after reset

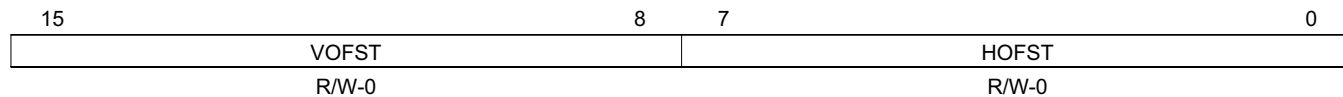
**Table 108. Color Space Converter - Coefficients #7 Register (CSCM7) Field Descriptions**

Bit	Field	Value	Description
15-8	CSCM33	0-FFh	Color space conversion coefficient value M33. This value is S8Q5.
7-0	CSCM32	0-FFh	Color space conversion coefficient value M32. This value is S8Q5.

### 6.1.65 Data Offset Register (DATAOFST)

The data offset register (DATAOFST) is shown in [Figure 144](#) and described in [Table 109](#).

**Figure 144. Data Offset Register (DATAOFST)**



LEGEND: R/W = Read/Write; -n = value after reset

**Table 109. Data Offset Register (DATAOFST) Field Descriptions**

Bit	Field	Value	Description
15-8	VOFST	0-FFh	V direction data offset for defect correction and lens shading correction. Range: 0-255.
7-0	HOFST	0-FFh	H direction data offset for defect correction and lens shading Correction. Range: 0-255.

## 6.2 Image Pipe Input Interface Registers (IPIPEIF)

The Image Pipe Input Interface registers are shown in [Table 110](#).

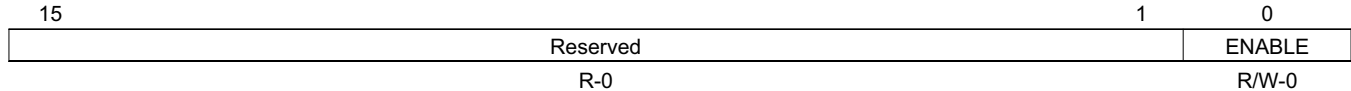
**Table 110. Image Pipe Input Interface Register Map (IPIPEIF)**

Address	Acronym	Register Description	Section
0x01C7:0100	ENABLE	IPIPE I/F Enable	<a href="#">Section 6.2.1</a>
0x01C7:0104	CFG	IPIPE I/F Configuration	<a href="#">Section 6.2.2</a>
0x01C7:0108	PPLN	IPIPE I/F Interval of HD / Start pixel in HD	<a href="#">Section 6.2.3</a>
0x01C7:010C	LPFR	IPIPE I/F Interval of VD / Start line in VD	<a href="#">Section 6.2.4</a>
0x01C7:0110	HNUM	IPIPE I/F Number of valid pixels per line	<a href="#">Section 6.2.5</a>
0x01C7:0114	VNUM	IPIPE I/F Number of valid lines per frame	<a href="#">Section 6.2.6</a>
0x01C7:0118	ADDRU	IPIPE I/F Memory Address (Upper)	<a href="#">Section 6.2.7</a>
0x01C7:011C	ADDRL	IPIPE I/F Memory Address (Lower)	<a href="#">Section 6.2.8</a>
0x01C7:0120	ADOFS	IPIPE I/F Address offset of each line	<a href="#">Section 6.2.9</a>
0x01C7:0124	RSZ	IPIPE I/F Horizontal Resizing Parameter	<a href="#">Section 6.2.10</a>
0x01C7:0128	GAIN	IPIPE I/F Gain Parameter	<a href="#">Section 6.2.11</a>

### 6.2.1 IPIPE I/F Enable Register (ENABLE)

The IPIPE I/F enable (ENABLE) register is shown in [Figure 145](#) and described in [Table 111](#).

**Figure 145. IPIPE I/F Enable Register (ENABLE)**



LEGEND: R/W = Read/Write; R = Read only; -n = value after reset

**Table 111. IPIPE I/F Enable Register (ENABLE) Field Descriptions**

Bit	Field	Value	Description
15-1	Reserved	0	Reserved.
0	ENABLE	0 1	IPIPE I/F Enable This register used to start the operation of SDRAM buffer memory read and generates SYNC signals. This register is available when INPSRC (CFG[3:2]) = 1, 2 or 3. 0 Disable 1 Enable

### 6.2.2 IPIPE I/F Configuration Register (CFG)

The IPIPE I/F configuration register (CFG) is shown in [Figure 146](#) and described in [Table 112](#).

**Figure 146. IPIPE I/F Configuration Register (CFG)**

15	14	13	11	10	9	8	
Reserved		DATASFT			CLKSEL	IALAW	PACK8IN
R-0		R/W-2			R/W-0	R/W-0	R/W-0
7	6	4	3	2	1	0	
AVGFILT	CLKDIV		INPSRC		DECM	ONESHOT	
R/W-0	R/W-0		R/W-0		R/W-0	R/W-0	

LEGEND: R/W = Read/Write; R = Read only; -n = value after reset

**Table 112. IPIPE I/F Configuration Register (CFG) Field Descriptions**

Bit	Field	Value	Description
15-14	Reserved	0	Reserved. Read as zero.
13-11	DATASFT	0 1 2 3 4 5 6	SDRAM Read Data Shift (0_6) This register is available when INPSRC = 1 or 2. Output data (13:0) = read data(15:2) Output data (13:0) = read data(14:1) Output data (13:0) = read data(13:0) Output data (13:0) = read data(12:0) & "0" Output data (13:0) = read data(11:0) & "00" Output data (13:0) = read data(10:0) & "000" Output data (13:0) = read data(9:0) & "0000"
10	CLKSEL	0 1	IPIPEIF & IPIPE Clock Select This register is available when INPSRC = 1 or 3. Should code "0" when INPSRC = 0 or 2. Pixel clock (PCLK) Divided SDRAM clock as per CLKDIV
9	IALAW	0 1	Inverse A-law Conversion Applies inverse A-law (8bit to 10bit) conversion to the SDRAM data. This register is available when INPSRC = 1 or 2. Inverse alaw off Inverse alaw on
8	PACK8IN	0 1	8-Bit Packed Mode When CCD raw data is stored in 8-bit packed mode, this register should code "1". This register is effective when INPSRC = 1 or 2. (NORMAL_16_BITS_PIXEL) 16 bits / pixel (PACK_8_BITS_PIXEL) 8 bits / pixel
7	AVGFILT	0 1	Averaging Filter It applies (1,2,1) filter for the RGB/YCbCr data. Off On

**Table 112. IPIPE I/F Configuration Register (CFG) Field Descriptions (continued)**

Bit	Field	Value	Description
6-4	CLKDIV	0 1 2 3 4 5 6 7	Clock Selection when Offline Mode (SDRAM Input Mode) IPIPEIF/IPIPE clock frequency = CLKDIV x VPSSCLK clock frequency This register is available when CLKSEL = 1 1/2 1/3 1/4 1/5 1/6 1/8 1/16 1/32
3-2	INPSRC	0 1 2 3	CCD/YCbCr Data Port Selection 0 From CCD Controller 1 From SDRAM (raw data) 2 From CCD Controller & SDRAM (Darkframe) 3 From SDRAM (YCbCr data)
1	DECM	0 1	Pixel Decimation Decimation rate defined by RSZ register 0 No decimation 1 Decimate
0	ONESHOT	0 1	One Shot Mode This register is available when INPSRC = 1 or 3. 0 Continuous mode 1 One shot mode

### 6.2.3 IPIPE I/F Interval of HD / Start pixel in HD Register (PPLN)

The PIPE I/F interval of HD /start pixel in HD register (PPLN) is shown in [Figure 147](#) and described in [Table 113](#).

**Figure 147. PIPE I/F Interval of HD / Start pixel in HD Register (PPLN)**

15	13	12	0
Reserved		PPLN	
R-0		R/W-0	

LEGEND: R/W = Read/Write; R = Read only; -n = value after reset

**Table 113. PIPE I/F Interval of HD / Start pixel in HD Register (PPLN) Field Descriptions**

Bit	Field	Value	Description
15-13	Reserved	0	Reserved. Read as zero.
12-0	PPLN	0-1FFFh	Case-1: Interval of Horizontal Sync (HD) Specifies the interval of horizontal sync. This register is available when INPSRC = 1 or 3.  Case-2: Start Pixel in Horizontal Sync (HD) Specifies the start pixel in horizontal sync. This register is available when INPSRC = 2

### 6.2.4 IPIPE I/F Interval of VD / Start line in VD Register (LPFR)

The IPIPE I/F interval of VD / start line in VD register (LPFR) is shown in [Figure 148](#) and described in [Table 114](#).

**Figure 148. IPIPE I/F Interval of VD / Start line in VD Register (LPFR)**

15	13	12	0
Reserved		LPFR	
R-0		R/W-0	

LEGEND: R/W = Read/Write; R = Read only; -n = value after reset

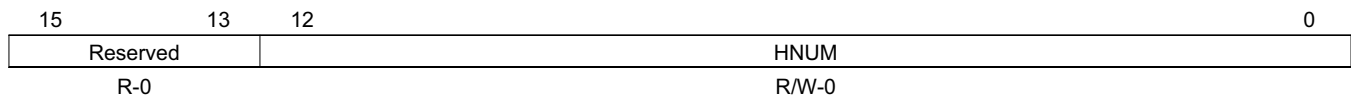
**Table 114. IPIPE I/F Interval of VD / Start line in VD Register (LPFR) Field Descriptions**

Bit	Field	Value	Description
15-13	Reserved	0	Reserved. Read as zero.
12-0	LPFR	0-1FFFh	Case-1: Interval of Vertical Sync (VD) Specifies the interval of vertical sync. This register is available when INPSRC = 1 or 3.  Case-2: Start Pixel in Vertical Sync (VD) Specifies the start line in vertical sync. This register is available when INPSRC = 2

### 6.2.5 IPIPE I/F Number of valid pixels per line Register (HNUM)

The IPIPE I/F number of valid pixels per line register (HNUM) is shown in [Figure 149](#) and described in [Table 115](#).

**Figure 149. IPIPE I/F Number of valid pixels per line Register (HNUM)**



LEGEND: R = Read only; -n = value after reset

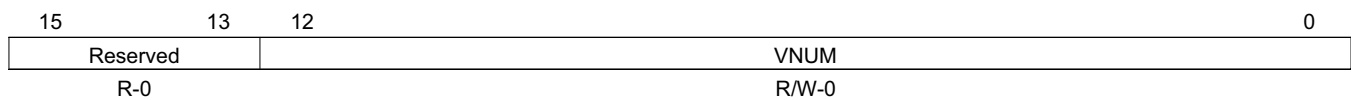
**Table 115. IPIPE I/F Number of valid pixels per line Register (HNUM) Field Descriptions**

Bit	Field	Value	Description
15-13	Reserved	0	Reserved.
12-0	HNUM	0-1FFFh	The Number of Valid Pixel in a Line Specifies the number of valid pixel in a horizontal line. This register is available when INPSRC = 1, 2 or 3

### 6.2.6 IPIPE I/F Number of Valid Lines per Frame Register (VNUM)

The IPIPE I/F number of valid lines per frame (VNUM) is shown in [Figure 150](#) and described in [Table 116](#).

**Figure 150. IPIPE I/F Number of Valid Lines per Frame Register (VNUM)**



LEGEND: R/W = Read/Write; R = Read only; -n = value after reset

**Table 116. IPIPE I/F Number of Valid Lines per Frame Register (VNUM) Field Descriptions**

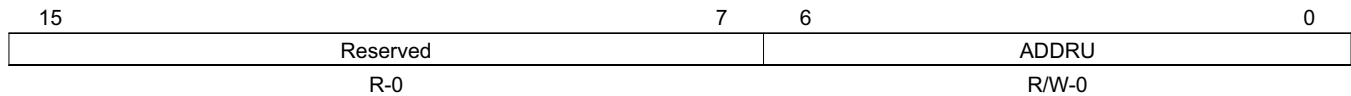
Bit	Field	Value	Description
15-13	Reserved	0	Reserved.
12-0	VNUM	0-1FFFh	The Number of Valid Lines in a Vertical Specifies the number of valid lines in a vertical. This register is available when INPSRC = 1, 2 or 3



### 6.2.7 IPIPE I/F Memory Address (Upper) Register (ADDRU)

The IPIPE I/F memory address (Upper) register (ADDRU) is shown in [Figure 151](#) and described in [Table 117](#).

**Figure 151. IPIPE I/F Memory Address (Upper) Register (ADDRU)**



LEGEND: R/W = Read/Write; R = Read only; -n = value after reset

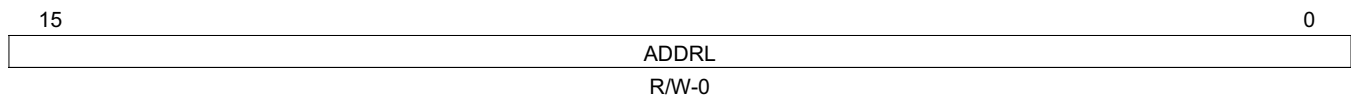
**Table 117. IPIPE I/F Memory Address (Upper) Register (ADDRU) Field Descriptions**

Bit	Field	Value	Description
15-7	Reserved	0	Reserved.
6-0	ADDRU	0-7Fh	Memory Address - Upper This register is available when INPSRC = 1, 2 or 3.

### 6.2.8 IPIPE I/F Memory Address (Lower) Register (ADDRL)

The IPIPE I/F memory address (Lower) register (ADDRL) is shown in [Figure 152](#) and described in [Table 118](#).

**Figure 152. IPIPE I/F Memory Address (Lower) Register (ADDRL)**



LEGEND: R/W = Read/Write; R = Read only; -n = value after reset

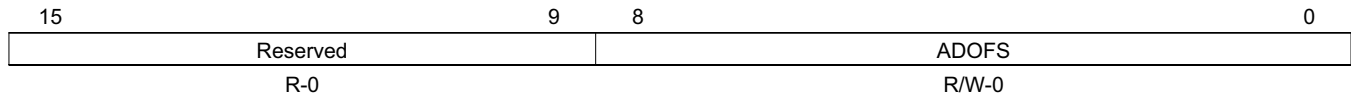
**Table 118. IPIPE I/F Memory Address (Lower) Register (ADDRL) Field Descriptions**

Bit	Field	Value	Description
15-0	ADDRL	0-FFFFh	Memory Address - Lower Memory address lower 16-bits are specified in units of 32-bytes. This register is available when INPSRC = 1, 2 or 3.

### 6.2.9 IPIPE I/F Address Offset of Each Line Register (ADOFS)

The IPIPE I/F address offset of each line (ADOFS) is shown in [Figure 153](#) and described in [Table 119](#).

**Figure 153. IPIPE I/F Address Offset of Each Line Register (ADOFS)**



LEGEND: R/W = Read/Write; R = Read only; -n = value after reset

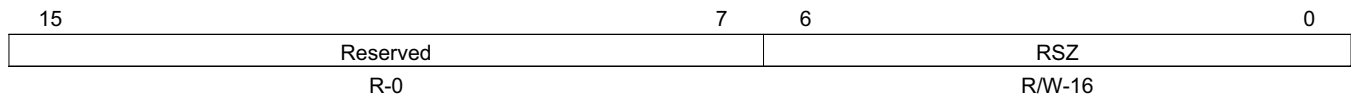
**Table 119. IPIPE I/F Address Offset of Each Line Register (ADOFS) Field Descriptions**

Bit	Field	Value	Description
15-9	Reserved	0	Reserved.
8-0	ADOFS	0-1FFh	The Address Offset of Each Line Specifies the offset address each start line is specified in units of 32-bytes. This register is available when INPSRC = 1, 2 or 3.

### 6.2.10 IPIPE I/F Horizontal Resizing Parameter Register (RSZ)

The IPIPE I/F Horizontal Resizing Parameter Register (RSZ) is shown in [Figure 154](#) and described in [Table 120](#).

**Figure 154. IPIPE I/F Horizontal Resizing Parameter Register (RSZ)**



LEGEND: R/W = Read/Write; R = Read only; -n = value after reset

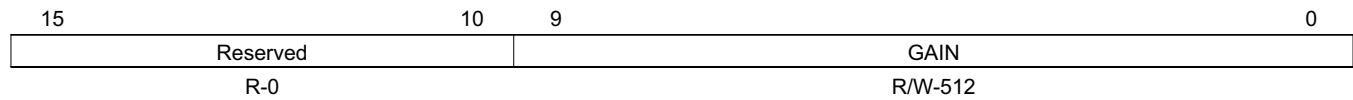
**Table 120. IPIPE I/F Horizontal Resizing Parameter Register (RSZ) Field Descriptions**

Bit	Field	Value	Description
15-7	Reserved	0	Reserved. Read as zero.
6-0	RSZ	10h-70h	The Horizontal Resizing Parameter Specifies the horizontal resizing parameter. The RSZ register can be configured within 16 to 112 range. This resizing ratio is determined by 16/RSZ (= 1/1 to 1/7).

### 6.2.11 IPIPE I/F Gain Parameter Register (GAIN)

The IPIPE I/F gain parameter register (GAIN) is shown in [Figure 155](#) and described in [Table 121](#).

**Figure 155. IPIPE I/F Gain Parameter Register (GAIN)**



LEGEND: R/W = Read/Write; R = Read only; -n = value after reset

**Table 121. IPIPE I/F Gain Parameter Register (GAIN) Field Descriptions**

Bit	Field	Value	Description
15-10	Reserved	0	Reserved. Read as zero.
9-0	GAIN	0-3FFh	Gain Parameter Specifies the gain parameter for IPIPE output data. The GAIN register can be configured within 0.00195(1/512) to 1.99805(1023/512) range. This gain default value is x1 gain. These bits don't influence Data of YCC.

### 6.3 Image Pipe Registers (IPIPE)

The Image Pipe registers are shown in [Table 122](#).

**Table 122. Image Pipe Registers (IPIPE)**

Address	Acronym	Register Description	Section
<b>Global Registers</b>			
0x01C7:1000	IPIPE_EN	IPIPE Enable Register	<a href="#">Section 6.3.1</a>
0x01C7:1004	IPIPE_MODE	One Shot Mode Register	<a href="#">Section 6.3.2</a>
0x01C7:1008	IPIPE_DPATHS	Input/Output Data Paths Register	<a href="#">Section 6.3.3</a>
0x01C7:100C	IPIPE_COLPAT	Color Pattern Register	<a href="#">Section 6.3.4</a>
0x01C7:1010	IPIPE_VST	Vertical Start Position Register	<a href="#">Section 6.3.5</a>
0x01C7:1014	IPIPE_VSZ	Vertical Processing Size Register	<a href="#">Section 6.3.6</a>
0x01C7:1018	IPIPE_HST	Horizontal Start Position Register	<a href="#">Section 6.3.7</a>
0x01C7:101C	IPIPE_HSZ	Horizontal Processing Size Register	<a href="#">Section 6.3.8</a>
<b>Gated Clock Enables</b>			
0x01C7:1024	GCL_ARM	ARM Gated Clock Control Register	<a href="#">Section 6.3.9</a>
0x01C7:1028	GCL_CCD	CCD Gated Clock Control Register	<a href="#">Section 6.3.10</a>
0x01C7:102C	GCL_SDR	SDR Gated Clock Control Register	<a href="#">Section 6.3.11</a>
<b>Internal Memory Access</b>			
0x01C7:1030	RAM_MODE	Internal Table Selection Register	<a href="#">Section 6.3.12</a>
0x01C7:1034	RAM_ADR	Address Register	<a href="#">Section 6.3.13</a>
0x01C7:1038	RAM_WDT	Write Data Register	<a href="#">Section 6.3.14</a>
0x01C7:103C	RAM_RDT	Read Data Register	<a href="#">Section 6.3.15</a>
<b>Interrupts</b>			
0x01C7:1040	IRQ_EN	Interrupt Enable Register	<a href="#">Section 6.3.16</a>
0x01C7:1044	IRQ_RZA	Interval of IRQ-2 Register	<a href="#">Section 6.3.17</a>
0x01C7:1048	IRQ_RZB	Interval of IRQ-3 Register	<a href="#">Section 6.3.18</a>
<b>Defect Correction</b>			
0x01C7:104C	DFC_EN	Defect Correction Enable Register	<a href="#">Section 6.3.19</a>
0x01C7:1050	DFC_SEL	Copy Method Selection (from Top or from Bottom) Register	<a href="#">Section 6.3.20</a>
0x01C7:1054	DFC_ADR	Start Address in LUT Register	<a href="#">Section 6.3.21</a>
0x01C7:1058	DFC_SIZ	Number of Available Entries in LUT Register	<a href="#">Section 6.3.22</a>
<b>Programmable Noise Filter</b>			
0x01C7:105C	D2F_EN	2D Noise Filter Enable Register	<a href="#">Section 6.3.23</a>
0x01C7:1060	D2F_CFG	Noise Filter Configuration Register	<a href="#">Section 6.3.24</a>
0x01C7:1064	D2F_THR[32]	Noise Filter LUT Values (Threshold) Register	<a href="#">Section 6.3.25</a>
0x01C7:10E4	D2F_STR[32]	Noise Filter LUT Values (Intensity) Register	<a href="#">Section 6.3.26</a>
<b>Pre-filter</b>			
0x01C7:1164	PRE_EN	PreFilter Enable Register	<a href="#">Section 6.3.27</a>
0x01C7:1168	PRE_TYP	PreFilter Type Register	<a href="#">Section 6.3.28</a>
0x01C7:116C	PRE_SHF	Shift Value of Adaptive Gain Register	<a href="#">Section 6.3.29</a>
0x01C7:1170	PRE_GAIN	Constant Gain or Adaptive Gain Slope Register	<a href="#">Section 6.3.30</a>
0x01C7:1174	PRE_THR_G	Threshold G Register	<a href="#">Section 6.3.31</a>
0x01C7:1178	PRE_THR_B	Threshold B Register	<a href="#">Section 6.3.32</a>
0x01C7:117C	PRE_THR_1	Threshold 1 Register	<a href="#">Section 6.3.33</a>
<b>White Balance</b>			
0x01C7:1180	WB2_DGN	Digital Gain Register	<a href="#">Section 6.3.34</a>
0x01C7:1184	WB2_WG_R	White Balance Gain (Red) Register	<a href="#">Section 6.3.35</a>
0x01C7:1188	WB2_WG_GR	White Balance Gain (GR) Register	<a href="#">Section 6.3.36</a>

**Table 122. Image Pipe Registers (IPIPE) (continued)**

Address	Acronym	Register Description	Section
0x01C7:118C	WB2_WG_GB	White Balance Gain (GB) Register	<a href="#">Section 6.3.37</a>
0x01C7:1190	WB2_WG_B	White Balance Gain (Blue) Register	<a href="#">Section 6.3.38</a>
<b>RGB to RGB Conversion (Include GAMMA Correction)</b>			
0x01C7:11F4	RGB_MUL_RR	Matrix Coefficient RR Register	<a href="#">Section 6.3.39</a>
0x01C7:11F8	RGB_MUL_GR	Matrix Coefficient GR Register	<a href="#">Section 6.3.40</a>
0x01C7:11FC	RGB_MUL_BR	Matrix Coefficient BR Register	<a href="#">Section 6.3.41</a>
0x01C7:1200	RGB_MUL_RG	Matrix Coefficient RG Register	<a href="#">Section 6.3.42</a>
0x01C7:1204	RGB_MUL_GG	Matrix Coefficient GG Register	<a href="#">Section 6.3.43</a>
0x01C7:1208	RGB_MUL_BG	Matrix Coefficient BG Register	<a href="#">Section 6.3.44</a>
0x01C7:120C	RGB_MUL_RB	Matrix Coefficient RB Register	<a href="#">Section 6.3.45</a>
0x01C7:1210	RGB_MUL_GB	Matrix Coefficient GB Register	<a href="#">Section 6.3.46</a>
0x01C7:1214	RGB_MUL_BB	Matrix Coefficient BB Register	<a href="#">Section 6.3.47</a>
0x01C7:1218	RGB_OFT_OR	R Output Offset Register	<a href="#">Section 6.3.48</a>
0x01C7:121C	RGB_OFT_OG	G Output Offset Register	<a href="#">Section 6.3.49</a>
0x01C7:1220	RGB_OFT_OB	B Output Offset Register	<a href="#">Section 6.3.50</a>
0x01C7:1224	GMM_CFG	Gamma Correction Configuration Register	<a href="#">Section 6.3.51</a>
<b>RGB to YCbCr Conversion</b>			
0x01C7:1228	YCC_ADJ	Luminance Adjustment (Contrast and Brightness) Register	<a href="#">Section 6.3.52</a>
0x01C7:122C	YCC_MUL_RY	Matrix Coefficient RY Register	<a href="#">Section 6.3.53</a>
0x01C7:1230	YCC_MUL_GY	Matrix Coefficient GY Register	<a href="#">Section 6.3.54</a>
0x01C7:1234	YCC_MUL_BY	Matrix Coefficient BY Register	<a href="#">Section 6.3.55</a>
0x01C7:1238	YCC_MUL_RCB	Matrix Coefficient RCb Register	<a href="#">Section 6.3.56</a>
0x01C7:123C	YCC_MUL_GCB	Matrix Coefficient GCb Register	<a href="#">Section 6.3.57</a>
0x01C7:1240	YCC_MUL_BCB	Matrix Coefficient BCb Register	<a href="#">Section 6.3.58</a>
0x01C7:1244	YCC_MUL_RCR	Matrix Coefficient RCr Register	<a href="#">Section 6.3.59</a>
0x01C7:1248	YCC_MUL_GCR	Matrix Coefficient GCr Register	<a href="#">Section 6.3.60</a>
0x01C7:124C	YCC_MUL_BCR	Matrix Coefficient BCr Register	<a href="#">Section 6.3.61</a>
0x01C7:1250	YCC_OFT_Y	Y Output Offset Register	<a href="#">Section 6.3.62</a>
0x01C7:1254	YCC_OFT_CB	Cb Output Offset Register	<a href="#">Section 6.3.63</a>
0x01C7:1258	YCC_OFT_CR	Cr Output Offset Register	<a href="#">Section 6.3.64</a>
0x01C7:125C	YCC_Y_MIN	Saturation (Luminance Minimum) Register	<a href="#">Section 6.3.65</a>
0x01C7:1260	YCC_Y_MAX	Saturation (Luminance Maximum) Register	<a href="#">Section 6.3.66</a>
0x01C7:1264	YCC_C_MIN	Saturation (Chrominance Minimum) Register	<a href="#">Section 6.3.67</a>
0x01C7:1268	YCC_C_MAX	Saturation (Chrominance Maximum) Register	<a href="#">Section 6.3.68</a>
0x01C7:126C	YCC_PHS	Chrominance Position (for 422 Down Sampler) Register	<a href="#">Section 6.3.69</a>
<b>Edge Enhancer</b>			
0x01C7:1270	YEE_EN	Edge Enhancer Enable Register	<a href="#">Section 6.3.70</a>
0x01C7:1274	YEE_EMF	MedianNR Enable Register	<a href="#">Section 6.3.71</a>
0x01C7:1278	YEE_SHF	HPF Shift Length Register	<a href="#">Section 6.3.72</a>
0x01C7:127C	YEE_MUL_00	HPF Coefficient 00 Register	<a href="#">Section 6.3.73</a>
0x01C7:1280	YEE_MUL_01	HPF Coefficient 01 Register	<a href="#">Section 6.3.74</a>
0x01C7:1284	YEE_MUL_02	HPF Coefficient 02 Register	<a href="#">Section 6.3.75</a>
0x01C7:1288	YEE_MUL_10	HPF Coefficient 10 Register	<a href="#">Section 6.3.76</a>
0x01C7:128C	YEE_MUL_11	HPF Coefficient 11 Register	<a href="#">Section 6.3.77</a>
0x01C7:1290	YEE_MUL_12	HPF Coefficient 12 Register	<a href="#">Section 6.3.78</a>
0x01C7:1294	YEE_MUL_20	HPF Coefficient 20 Register	<a href="#">Section 6.3.79</a>

**Table 122. Image Pipe Registers (IPIPE) (continued)**

Address	Acronym	Register Description	Section
0x01C7:1298	YEE_MUL_21	HPF Coefficient 21 Register	<a href="#">Section 6.3.80</a>
0x01C7:129C	YEE_MUL_22	HPF Coefficient 22 Register	<a href="#">Section 6.3.81</a>
<b>False Color Suppression</b>			
0x01C7:12A0	FCS_EN	Fault Color Suppression Enable Register	<a href="#">Section 6.3.82</a>
0x01C7:12A4	FCS_TYP	Type Selection of HPF Register	<a href="#">Section 6.3.83</a>
0x01C7:12A8	FCS_SHF_Y	Down Shift Size (HPF) Register	<a href="#">Section 6.3.84</a>
0x01C7:12AC	FCS_SHF_C	Down Shift size (GAIN) Register	<a href="#">Section 6.3.85</a>
0x01C7:12B0	FCS_THR	Threshold Register	<a href="#">Section 6.3.86</a>
0x01C7:12B4	FCS_SGN	Intensity Register	<a href="#">Section 6.3.87</a>
0x01C7:12B8	FCS_LTH	Lower Limit of Chroma Gain Register	<a href="#">Section 6.3.88</a>
<b>Resizer</b>			
0x01C7:12BC	RSZ_SEQ	Processing Mode Register	<a href="#">Section 6.3.89</a>
0x01C7:12C0	RSZ_AAL	Vertical Anti Aliasing Filter Register	<a href="#">Section 6.3.90</a>
<b>RSZ 0</b>			
<b>Resizer Rescale Parameters</b>			
0x01C7:12C4	RSZ_EN	Resizer Enable Register	<a href="#">Section 6.3.91</a>
0x01C7:12C8	RSZ_MODE	One Shot Mode Register	<a href="#">Section 6.3.92</a>
0x01C7:12CC	RSZ_I_VST	Vertical Start Position of the Input Register	<a href="#">Section 6.3.93</a>
0x01C7:12D0	RSZ_I_VSZ	Vertical Size of the Input Register	<a href="#">Section 6.3.94</a>
0x01C7:12D4	RSZ_I_HST	Horizontal Start Position of the Input Register	<a href="#">Section 6.3.95</a>
0x01C7:12D8	RSZ_O_VSZ	Vertical Size of the Output Register	<a href="#">Section 6.3.96</a>
0x01C7:12DC	RSZ_O_HST	Horizontal Start Position of the Output Register	<a href="#">Section 6.3.97</a>
0x01C7:12E0	RSZ_O_HSZ	Horizontal Size of the Output Register	<a href="#">Section 6.3.98</a>
0x01C7:12E4	RSZ_V_PHS	Initial Phase of Vertical Resizing Process Register	<a href="#">Section 6.3.99</a>
0x01C7:12E8	RSZ_V_PHS_O	Phase of Last Value in Previous Resize Process Register	<a href="#">Section 6.3.100</a>
0x01C7:12EC	RSZ_V_DIF	Vertical Resize Parameter Register	<a href="#">Section 6.3.101</a>
0x01C7:12F0	RSZ_V_SIZ_O	Actual Number of Output Lines Register	<a href="#">Section 6.3.102</a>
0x01C7:12F4	RSZ_H_PHS	Initial Phase of Horizontal Resizing Process Register	<a href="#">Section 6.3.103</a>
0x01C7:12F8	RSZ_H_DIF	Horizontal Resize Parameter Register	<a href="#">Section 6.3.104</a>
0x01C7:12FC	RSZ_H_TYP	Interpolation Method for Horizontal Rescaling Register	<a href="#">Section 6.3.105</a>
0x01C7:1300	RSZ_H_LSE	Selection of Horizontal LPF Intensity Register	<a href="#">Section 6.3.106</a>
0x01C7:1304	RSZ_H_LPF	Horizontal LPF Intensity Register	<a href="#">Section 6.3.107</a>
<b>Resizer RGB Conversion Parameters</b>			
0x01C7:1308	RSZ_RGB_EN	RGB Output Enable Register	<a href="#">Section 6.3.108</a>
0x01C7:130C	RSZ_RGB_TYP	RGB Output Bit Mode (32 or 16 bit) Register	<a href="#">Section 6.3.109</a>
0x01C7:1310	RSZ_RGB_BLD	YC422 to YC444 Conversion Method Register	<a href="#">Section 6.3.110</a>
<b>Resizer External Memory Parameters</b>			
0x01C7:1314	RSZ_SDR_BAD_H	SDRAM Base Address MSB Register	<a href="#">Section 6.3.111</a>
0x01C7:1318	RSZ_SDR_BAD_L	SDRAM Base Address LSB Register	<a href="#">Section 6.3.112</a>
0x01C7:131C	RSZ_SDR_SAD_H	SDRAM Start Address MSB Register	<a href="#">Section 6.3.113</a>
0x01C7:1320	RSZ_SDR_SAD_L	SDRAM Start Address LSB Register	<a href="#">Section 6.3.114</a>
0x01C7:1324	RSZ_SDR_OFT	SDRAM Line Offset Register	<a href="#">Section 6.3.115</a>
0x01C7:1328	RSZ_SDR_PTR_S	Start Line of SDRAM Pointer Register	<a href="#">Section 6.3.116</a>
0x01C7:132C	RSZ_SDR_PTR_E	End line of SDRAM Pointer Register	<a href="#">Section 6.3.117</a>
0x01C7:1330	RSZ_SDR_PTR_O	Output of Current Pointer Value (Read Only) Register	<a href="#">Section 6.3.118</a>

**Table 122. Image Pipe Registers (IPIPE) (continued)**

Address	Acronym	Register Description	Section
<b>RSZ 1</b>			
<b>Resizer Rescale Parameters</b>			
0x01C7:1334	RSZ_EN	Resizer Enable Register	<a href="#">Section 6.3.91</a>
0x01C7:1338	RSZ_MODE	One Shot Mode Register	<a href="#">Section 6.3.92</a>
0x01C7:133C	RSZ_I_VST	Vertical Start Position of the Input Register	<a href="#">Section 6.3.93</a>
0x01C7:1340	RSZ_I_VSZ	Vertical Size of the Input Register	<a href="#">Section 6.3.94</a>
0x01C7:1344	RSZ_I_HST	Horizontal Start Position of the Input Register	<a href="#">Section 6.3.95</a>
0x01C7:1348	RSZ_O_VSZ	Vertical Size of the Output Register	<a href="#">Section 6.3.96</a>
0x01C7:134C	RSZ_O_HST	Horizontal Start Position of the Output Register	<a href="#">Section 6.3.97</a>
0x01C7:1350	RSZ_O_HSZ	Horizontal Size of the Output Register	<a href="#">Section 6.3.98</a>
0x01C7:1354	RSZ_V_PHS	Initial Phase of Vertical Resizing Process Register	<a href="#">Section 6.3.99</a>
0x01C7:1358	RSZ_V_PHS_O	Phase of Last Value in Previous Resize Process Register	<a href="#">Section 6.3.100</a>
0x01C7:135C	RSZ_V_DIF	Vertical Resize Parameter Register	<a href="#">Section 6.3.101</a>
0x01C7:1360	RSZ_V_SIZ_O	Actual Number of Output Lines Register	<a href="#">Section 6.3.102</a>
0x01C7:1364	RSZ_H_PHS	Initial Phase of Horizontal Resizing Process Register	<a href="#">Section 6.3.103</a>
0x01C7:1368	RSZ_H_DIF	Horizontal Resize Parameter Register	<a href="#">Section 6.3.104</a>
0x01C7:136C	RSZ_H_TYP	Interpolation Method for Horizontal Rescaling Register	<a href="#">Section 6.3.105</a>
0x01C7:1370	RSZ_H_LSE	Selection of Horizontal LPF Intensity Register	<a href="#">Section 6.3.106</a>
0x01C7:1374	RSZ_H_LPF	Horizontal LPF Intensity Register	<a href="#">Section 6.3.107</a>
<b>Resizer RGB Conversion Parameters</b>			
0x01C7:1378	RSZ_RGB_EN	RGB Output Enable Register	<a href="#">Section 6.3.108</a>
0x01C7:137C	RSZ_RGB_TYP	RGB Output Bit Mode (32 or 16 bit) Register	<a href="#">Section 6.3.109</a>
0x01C7:1380	RSZ_RGB_BLD	YC422 to YC444 Conversion Method Register	<a href="#">Section 6.3.110</a>
<b>Resizer External Memory Parameters</b>			
0x01C7:1384	RSZ_SDR_BAD_H	SDRAM Base Address MSB Register	<a href="#">Section 6.3.111</a>
0x01C7:1388	RSZ_SDR_BAD_L	SDRAM Base Address LSB Register	<a href="#">Section 6.3.112</a>
0x01C7:138C	RSZ_SDR_SAD_H	SDRAM Start Address MSB Register	<a href="#">Section 6.3.113</a>
0x01C7:1390	RSZ_SDR_SAD_L	SDRAM Start Address LSB Register	<a href="#">Section 6.3.114</a>
0x01C7:1394	RSZ_SDR_OFT	SDRAM Line Offset Register	<a href="#">Section 6.3.115</a>
0x01C7:1398	RSZ_SDR_PTR_S	Start Line of SDRAM Pointer Register	<a href="#">Section 6.3.116</a>
0x01C7:139C	RSZ_SDR_PTR_E	End line of SDRAM Pointer Register	<a href="#">Section 6.3.117</a>
0x01C7:13A0	RSZ_SDR_PTR_O	Output of Current Pointer Value (Read Only) Register	<a href="#">Section 6.3.118</a>
<b>Boxcar (2d)</b>			
0x01C7:13A4	BOX_EN	Boxcar Enable Register	<a href="#">Section 6.3.119</a>
0x01C7:13A8	BOX_MODE	One Shot Mode Register	<a href="#">Section 6.3.120</a>
0x01C7:13AC	BOX_TYP	Block Size (16x16 or 8x8) Register	<a href="#">Section 6.3.121</a>
0x01C7:13B0	BOX_SHF	Down Shift Value of Input Register	<a href="#">Section 6.3.122</a>
0x01C7:13B4	HST_EN	Histogram Enable Register	<a href="#">Section 6.3.123</a>
0x01C7:13B8	HST_MODE	One Shot Mode Register	<a href="#">Section 6.3.124</a>
0x01C7:13BC	HST_SEL	Histogram Source Select Register	<a href="#">Section 6.3.125</a>
0x01C7:13C0	HST_PARA	Histogram Parameters Select Register	<a href="#">Section 6.3.126</a>

**Table 122. Image Pipe Registers (IPIPE) (continued)**

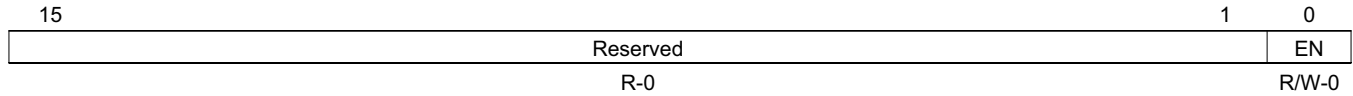
Address	Acronym	Register Description	Section
<b>Histogram Region Definitions</b>			
<b>Histogram Region 0</b>			
0x01C7:13C4	HST_VST	Vertical Start Position Register	<a href="#">Section 6.3.127</a>
0x01C7:13C8	HST_VSZ	Vertical Size Register	<a href="#">Section 6.3.128</a>
0x01C7:13CC	HST_HST	Horizontal Start Position Register	<a href="#">Section 6.3.129</a>
0x01C7:13D0	HST_HSZ	Horizontal Size Register	<a href="#">Section 6.3.130</a>
<b>Histogram Region 1</b>			
0x01C7:13D4	HST_VST	Vertical Start Position Register	<a href="#">Section 6.3.127</a>
0x01C7:13D8	HST_VSZ	Vertical Size Register	<a href="#">Section 6.3.128</a>
0x01C7:13DC	HST_HST	Horizontal Start Position Register	<a href="#">Section 6.3.129</a>
0x01C7:13E0	HST_HSZ	Horizontal Size Register	<a href="#">Section 6.3.130</a>
<b>Histogram Region 2</b>			
0x01C7:13E4	HST_VST	Vertical Start Position Register	<a href="#">Section 6.3.127</a>
0x01C7:13E8	HST_VSZ	Vertical Size Register	<a href="#">Section 6.3.128</a>
0x01C7:13EC	HST_HST	Horizontal Start Position Register	<a href="#">Section 6.3.129</a>
0x01C7:13F0	HST_HSZ	Horizontal Size Register	<a href="#">Section 6.3.130</a>
<b>Histogram Region 3</b>			
0x01C7:13F4	HST_VST	Vertical Start Position Register	<a href="#">Section 6.3.127</a>
0x01C7:13F8	HST_VSZ	Vertical Size Register	<a href="#">Section 6.3.128</a>
0x01C7:13FC	HST_HST	Horizontal Start Position Register	<a href="#">Section 6.3.129</a>
0x01C7:1400	HST_HSZ	Horizontal Size Register	<a href="#">Section 6.3.130</a>



### 6.3.1 IPIPE Enable Register (IPIPE\_EN)

The IPIPE enable register (IPIPE\_EN) is shown in [Figure 156](#) and described in [Table 123](#).

**Figure 156. IPIPE Enable Register (IPIPE\_EN)**



LEGEND: R/W = Read/Write; R = Read only; -n = value after reset

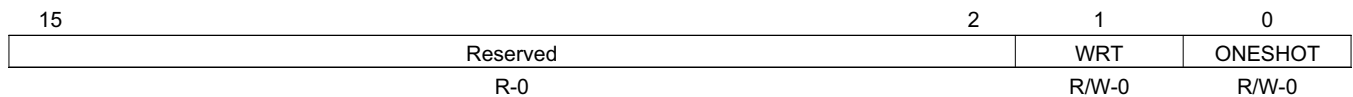
**Table 123. IPIPE Enable Register (IPIPE\_EN) Field Descriptions**

Bit	Field	Value	Description
15-1	Reserved	0	Reserved
0	EN	0 1	The start flag of the IPIPE module. When EN is 1, the IPIPE module starts a processing from the next rising edge of the VD. If the processing mode of the IPIPE module is "one shot", the EN is cleared to 0 after the end of the processing area.  0 Disable. 1 Enable.

### 6.3.2 One Shot Mode Register (IPIPE\_MODE)

The one shot mode register (IPIPE\_MODE) is shown in [Figure 157](#) and described in [Table 124](#).

**Figure 157. One Shot Mode Register (IPIPE\_MODE)**



LEGEND: R/W = Read/Write; R = Read only; -n = value after reset

**Table 124. One Shot Mode Register (IPIPE\_MODE) Field Descriptions**

Bit	Field	Value	Description
15-2	Reserved	0	Reserved
1	WRT	0 1	CAM_WEN mode selection. The mode selection of processing based on CAM_WEN signal. If WRT is 0, the IPIPE module ignores CAM_WEN signal and processes every image frame while IPIPE is enabled. If WRT = 1, the IPIPE only processes frames that while CAM_WEN is high. This bit should be cleared when the input timing is generated by the IPIPEIF (not from CCDC).  0 Disable. 1 Enable.
0	ONESHOT	0 1	One shot mode. The processing mode selection of the IPIPE module. Value 0 indicates the mode of "free run", value 1 indicates the mode of "one shot".  0 Disable. 1 Enable

### 6.3.3 Input/Output Data Paths Register (IPIPE\_DPATHS)

The Input/Output data paths register (IPIPE\_DPATHS) is shown in [Figure 158](#) and described in [Table 125](#).

**Figure 158. Input/Output Data Paths Register (IPIPE\_DPATHS)**

15	3	2	1	0
Reserved			BYPASS	FMT
R-0			R/W-0	R/W-0

LEGEND: R/W = Read/Write; R = Read only; -n = value after reset

**Table 125. Input/Output Data Paths Register (IPIPE\_DPATHS) Field Descriptions**

Bit	Field	Value	Description
15-3	Reserved	0	Reserved
2	BYPASS	0 1	Enable RAW-Bypass mode through IPIPE. This mode enables passthru of RAW input for images up to 4096 pixels wide. This bit is valid only if FMT = 1 (Bayer input, bayer output). 0 Raw passthru mode off. 1 Raw passthru mode on.
0-1	FMT	0 1 2 3	Data Path through IPIPE. 0 (RAW2YUV) Bayer input, YCbCr (or RGB) output. 1 (RAW2RAW) Bayer input, Bayer output. 2 (RAW2BOX) Bayer input, Boxcar output. 3 (YUV2YUV) YCbCr (16bit) input, YCbCr (or RGB) output.

### 6.3.4 Color Pattern Register (IPIPE\_COLPAT)

The color pattern register (IPIPE\_COLPAT) is shown in [Figure 159](#) and described in [Table 126](#).

**Figure 159. Color Pattern Register (IPIPE\_COLPAT)**

15	8	7	6	5	4	3	2	1	0
Reserved				OLOP	OLEP	ELOP	ELEP		
R-0				R/W-3	R/W-2	R/W-1	R/W-0		

LEGEND: R/W = Read/Write; R = Read only; -n = value after reset

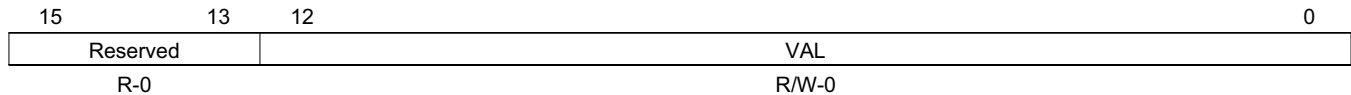
**Table 126. Color Pattern Register (IPIPE\_COLPAT) Field Descriptions**

Bit	Field	Value	Description
15-8	Reserved	0	Reserved.
7-6	OLOP	0	Color of the odd line and odd pixel. This parameter is valid when IPIPE_DPATHS[FMT] is 0. (R) Red.
		1	(Gr) Green (red line).
		2	(Gb) Green (blue line).
		3	(B) Blue.
5-4	OLEP	0	Color of the odd line and even pixel. This parameter is valid when IPIPE_DPATHS[FMT] is 0. (R) Red.
		1	(Gr) Green (red line).
		2	(Gb) Green (blue line).
		3	(B) Blue.
3-2	ELOP	0	Color of the even line and odd pixel. This parameter is valid when IPIPE_DPATHS[FMT] is 0. (R) Red.
		1	(Gr) Green (red line).
		2	(Gb) Green (blue line).
		3	(B) Blue.
1-0	ELEP	0	Color of the even line and even pixel. This parameter is valid when IPIPE_DPATHS[FMT] is 0. (R) Red.
		1	(Gr) Green (red line).
		2	(Gb) Green (blue line).
		3	(B) Blue.

### 6.3.5 Vertical Start Position Register (IPIPE\_VST)

The vertical start position register (IPIPE\_VST) is shown in [Figure 160](#) and described in [Table 127](#).

**Figure 160. Vertical Start Position Register (IPIPE\_VST)**



LEGEND: R/W = Read/Write; R = Read only; -n = value after reset

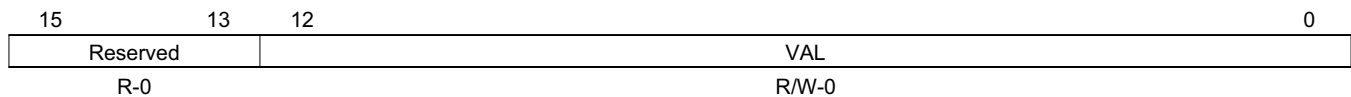
**Table 127. Vertical Start Position Register (IPIPE\_VST) Field Descriptions**

Bit	Field	Value	Description
15-13	Reserved	0	Reserved.
12-0	VAL	0-1FFFh	Vertical start position. The vertical position of the global frame from the rising edge of the VD. The IPIPE module will start an image processing from VAL line.

### 6.3.6 Vertical Processing Size Register (IPIPE\_VSZ)

The vertical processing size register (IPIPE\_VSZ) is shown in [Figure 161](#) and described in [Table 128](#).

**Figure 161. Vertical Processing Size Register (IPIPE\_VSZ)**



LEGEND: R/W = Read/Write; R = Read only; -n = value after reset

**Table 128. Vertical Processing Size Register (IPIPE\_VSZ) Field Descriptions**

Bit	Field	Value	Description
15-13	Reserved	0	Reserved.
12-0	VAL	0-1FFFh	Vertical processing size. The vertical size of the processing area. VAL[0] can not be written. The IPIPE module will process (VAL + 1) lines.

### 6.3.7 Horizontal Start Position Register (IPIPE\_HST)

The horizontal start position register (IPIPE\_HST) is shown in [Figure 162](#) and described in [Table 129](#).

**Figure 162. Horizontal Start Position Register (IPIPE\_HST)**

15	13	12	0
Reserved		VAL	
R-0		R/W-0	

LEGEND: R/W = Read/Write; R = Read only; -n = value after reset

**Table 129. Horizontal Start Position Register (IPIPE\_HST) Field Descriptions**

Bit	Field	Value	Description
15-13	Reserved	0	Reserved.
12-0	VAL	0-1FFFh	Horizontal start position. The horizontal position of the global frame from the rising edge of the HD. The IPIPE module will start an image processing from VAL pixel.

### 6.3.8 Horizontal Processing Size Register (IPIPE\_HSZ)

The horizontal processing size register (IPIPE\_HSZ) is shown in [Figure 163](#) and described in [Table 130](#).

**Figure 163. Horizontal Processing Size Register (IPIPE\_HSZ)**

15	13	12	0
Reserved		VAL	
R-0		R/W-0	

LEGEND: R/W = Read/Write; R = Read only; -n = value after reset

**Table 130. Horizontal Processing Size Register (IPIPE\_HSZ) Field Descriptions**

Bit	Field	Value	Description
15-13	Reserved	0	Reserved.
12-0	VAL	0-1FFFh	Horizontal processing size. The horizontal size of the processing area. VAL[0] can not be written. The IPIPE module will process (VAL + 1) pixels.

### 6.3.9 ARM Gated Clock Control Register (GCL\_ARM)

The ARM gated clock control register (GCL\_ARM) is shown in [Figure 164](#) and described in [Table 131](#).

**Figure 164. ARM Gated Clock Control Register (GCL\_ARM)**

15	Reserved	1	0
R-0			REG R/W-0

LEGEND: R/W = Read/Write; -n = value after reset

**Table 131. ARM Gated Clock Control Register (GCL\_ARM) Field Descriptions**

Bit	Field	Value	Description
15-1	Reserved	0	Reserved.
0	REG	0 1	IPIPE MMR clock enable. The on/off selection of the MMR interface clock which is used for ARM register accesses. Off On

### 6.3.10 CCD Gated Clock Control Register (GCL\_CCD)

The CCD gated clock control register (GCL\_CCD) is shown in [Figure 165](#) and described in [Table 132](#).

**Figure 165. CCD Gated Clock Control Register (GCL\_CCD)**

15	Reserved	3	2	1	0	
R-0				G2 R/W-0	G1 R/W-0	G0 R/W-0

LEGEND: R/W = Read/Write; R = Read only; -n = value after reset

**Table 132. CCD Gated Clock Control Register (GCL\_CCD) Field Descriptions**

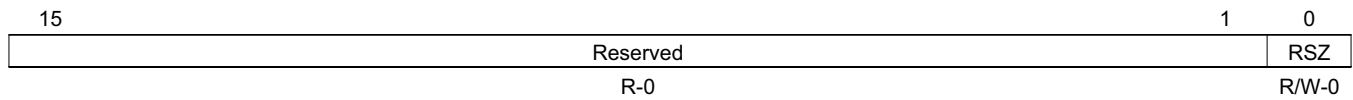
Bit	Field	Value	Description
15-3	Reserved	0	Reserved
2	G2	0 1	IPIPE G2 clock enable. The on/off selection of the clock which is used for the IPIPE processing of "CFA" to "422", "Histogram". Off On
1	G1	0 1	IPIPE G1 clock enable. The on/off selection of the clock which is used for the IPIPE processing of "Defect Correction" to "White Balance". Off On
0	G0	0 1	IPIPE G0 clock enable. The on/off selection of the clock which is used for the IPIPE processing of "Boxcar". Off On



### 6.3.11 SDR Gated Clock Control Register (GCL\_SDR)

The SDR gated clock control register (GCL\_ARM) is shown in [Figure 166](#) and described in [Table 133](#).

**Figure 166. SDR Gated Clock Control Register (GCL\_SDR)**



LEGEND: R/W = Read/Write; -n = value after reset

**Table 133. SDR Gated Clock Control Register (GCL\_SDR) Field Descriptions**

Bit	Field	Value	Description
15-1	Reserved	0	Reserved.
0	RSZ	0 1	IPIPE RSZ clock enable. The on/off selection of the clock which is used for "Resize". The resizer operates in bypass mode when this is off. Off On



### 6.3.12 Internal Table Selection Register (RAM\_MODE)

The internal table selection register (RAM\_MODE) is shown in [Figure 167](#) and described in [Table 134](#).

**Figure 167. Internal Table Selection Register (RAM\_MODE)**

15	14	7	6	5	4	3	0
WIT	Reserved			EXT	WDT	ADR	SEL
R-1	R-0			R/W-0	R/W-0	R/W-1	R/W-0

LEGEND: R/W = Read/Write; R = Read only; -n = value after reset

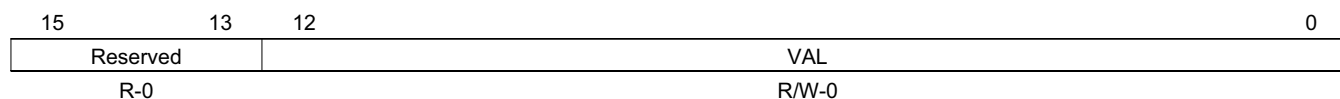
**Table 134. Internal Table Selection Register (RAM\_MODE) Field Descriptions**

Bit	Field	Value	Description
15	WIT	0 1	Internal wait flag. Value 0 indicates that the IPIPE module is busy. In this condition access to the RAM_xxx registers is prohibited. Busy. Not busy.
15-7	Reserved	0	Reserved.
6	EXT	0 1	Output selection of the IPIPE_NWAIT. Output. No output (Use WIT).
5	WDT	0 1	Write data enable. Value 0 indicates that RAM_WDT is written to the internal memory. Read only. Write.
4	ADR	0 1	Auto increment mode. Value 1 indicates that RAM_ADR adds to 1 after each memory access. Manual mode. Auto increment mode.
3-0	SEL	0 1 2 3 4 5 6 7 8 9	Memory selection. Histogram 0. Histogram 1. Reserved. Reserved. Defect correction. Gamma Red. Gamma Green. Gamma Blue. Gamma RGB all. Edge enhancer.

### 6.3.13 Address Register (RAM\_ADR)

The address register (RAM\_ADR) is shown in [Figure 168](#) and described in [Table 135](#).

**Figure 168. Address Register (RAM\_ADR)**



LEGEND: R/W = Read/Write; R = Read only; -n = value after reset

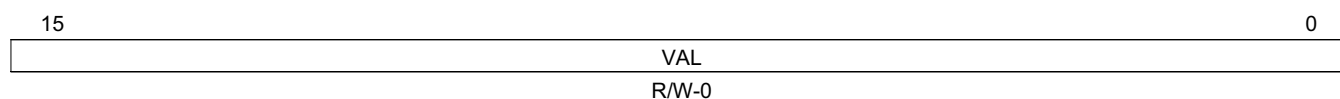
**Table 135. Address Register (RAM\_ADR) Field Descriptions**

Bit	Field	Value	Description
15-13	Reserved	0	Reserved.
12-0	VAL	0-1FFFh	Address of an internal memory.

### 6.3.14 Write Data Register (RAM\_WDT)

The write data register (RAM\_WDT) is shown in [Figure 169](#) and described in [Table 136](#).

**Figure 169. Write Data Register (RAM\_WDT)**



LEGEND: R/W = Read/Write; -n = value after reset

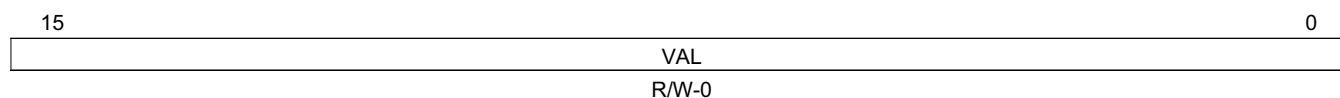
**Table 136. Write Data Register (RAM\_WDT) Field Descriptions**

Bit	Field	Value	Description
15-0	VAL	0-FFFFh	Write data value of an internal memory.

### 6.3.15 Read Data Register (RAM\_RDT)

The read data register (RAM\_RDT) is shown in [Figure 170](#) and described in [Table 137](#).

**Figure 170. Read Data Register (RAM\_RDT)**



LEGEND: R/W = Read/Write; -n = value after reset

**Table 137. Read Data Register (RAM\_RDT) Field Descriptions**

Bit	Field	Value	Description
15-0	VAL	0-FFFFh	Read data value of an internal memory.

### 6.3.16 Interrupt Enable Register (IRQ\_EN)

The interrupt enable register (IRQ\_EN) is shown in [Figure 171](#) and described in [Table 138](#).

**Figure 171. Interrupt Enable Register (IRQ\_EN)**

15	6	5	4	3	2	1	0
Reserved		INT5	INT4	INT3	INT2	INT1	INT0
R-0		R/W-0	R/W-0	R/W-0	R/W-0	R/W-1	R/W-0

LEGEND: R/W = Read/Write; R = Read only; -n = value after reset

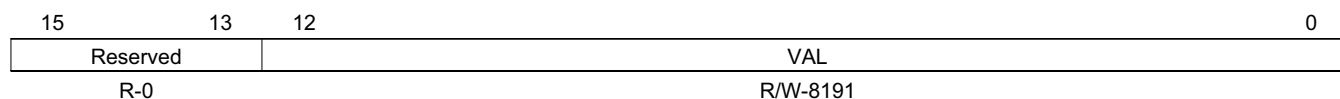
**Table 138. Interrupt Enable Register (IRQ\_EN) Field Descriptions**

Bit	Field	Value	Description
15-6	Reserved	0	Reserved.
5	INT5	0 1	IRQ5 enable. Interrupt signal to indicate the beginning of the time period in which update of registers is allowed. Disable. Enable.
4	INT4	0 1	IRQ4 enable. Interrupt signal to indicate the completion of boundary signal calculator. Disable. Enable.
3	INT3	0 1	IRQ3 enable. Refer to IRQ_RZB. Disable. Enable.
2	INT2	0 1	IRQ2 enable. Refer to IRQ_RZA. Disable. Enable.
1	INT1	0 1	IRQ1 enable. Interrupt signal to indicate that output of a frame to SDRAM is finished, either in IPIPE mode or Boxcar mode. Disable. Enable.
0	INT0	0 1	IRQ0 enable. Interrupt signal at the last pixel output in image_pipe (completion of histogram). Disable. Enable.

### 6.3.17 Interval of IRQ-2 Register (IRQ\_RZA)

The interval of IRQ-2 register (IRQ\_RZA) is shown in [Figure 172](#) and described in [Table 139](#).

**Figure 172. Interval of IRQ-2 Register (IRQ\_RZA)**



LEGEND: R/W = Read/Write; R = Read only; -n = value after reset

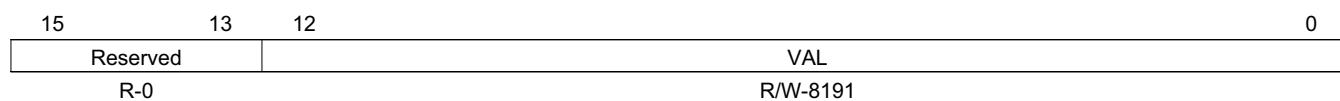
**Table 139. Interval of IRQ-2 Register (IRQ\_RZA) Field Descriptions**

Bit	Field	Value	Description
15-13	Reserved	0	Reserved.
12-0	VAL	0-1FFFh	Interval of IRQ_2. Interrupt signal at every (VAL + 1) lines of Resize and RGB output.

### 6.3.18 Interval of IRQ-3 Register (IRQ\_RZB)

The interval of IRQ-3 register (IRQ\_RZB) is shown in [Figure 173](#) and described in [Table 140](#).

**Figure 173. Interval of IRQ-3 Register (IRQ\_RZB)**



LEGEND: R/W = Read/Write; R = Read only; -n = value after reset

**Table 140. Interval of IRQ-3 Register (IRQ\_RZB) Field Descriptions**

Bit	Field	Value	Description
15-13	Reserved	0	Reserved.
12-0	VAL	0-1FFFh	Interval of IRQ_3. Interrupt signal at every (VAL + 1) lines of Resize and RGB output.

### 6.3.19 Defect Correction Enable Register (DFC\_EN)

The defect correction enable register (DFC\_EN) is shown in [Figure 174](#) and described in [Table 141](#).

**Figure 174. Defect Correction Enable Register (DFC\_EN)**

15	1	0
Reserved		EN
R-0		R/W-0

LEGEND: R/W = Read/Write; R = Read only; -n = value after reset

**Table 141. Defect Correction Enable Register (DFC\_EN) Field Descriptions**

Bit	Field	Value	Description
15-1	Reserved	0	Reserved.
0	EN		Defect correction enable.
		0	Disable.
		1	Enable.

### 6.3.20 Copy Method Selection (from Top or from Bottom) Register (DFC\_SEL)

The copy method selection (from top or from bottom) Register (DFC\_SEL) is shown in [Figure 175](#) and described in [Table 142](#).

**Figure 175. Copy Method Selection (from Top or from Bottom) Register (DFC\_SEL)**

15	1	0
Reserved		SEL
R-0		R/W-0

LEGEND: R/W = Read/Write; R = Read only; -n = value after reset

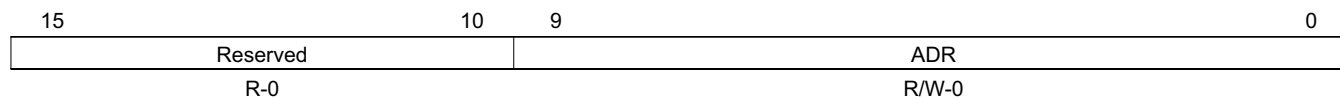
**Table 142. Copy Method Selection (from Top or from Bottom) Register (DFC\_SEL) Field Descriptions**

Bit	Field	Value	Description
15-1	Reserved	0	Reserved.
0	SEL		Copy method in vertical defect correction. Used when defect correction method for a pixel is set to option #7.
		0	From top.
		1	From bottom.

### 6.3.21 Start Address in LUT Register (DFC\_ADR)

The start address in LUT register (DFC\_ADR) is shown in [Figure 176](#) and described in [Table 143](#).

**Figure 176. Start Address in LUT Register (DFC\_ADR)**



LEGEND: R/W = Read/Write; R = Read only; -n = value after reset

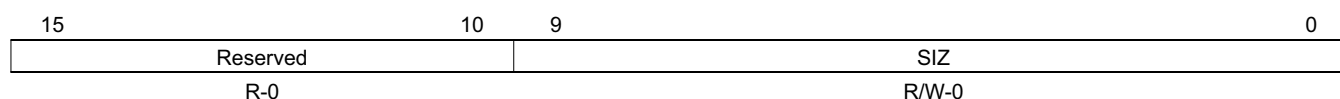
**Table 143. Start Address in LUT Register (DFC\_ADR) Field Descriptions**

Bit	Field	Value	Description
15-10	Reserved	0	Reserved
9-0	ADR	0-3FFh	Start Address in LUT.

### 6.3.22 Number of Available Entries in LUT Register (DFC\_SIZ)

The number of available entries in LUT register (DFC\_SIZ) is shown in [Figure 177](#) and described in [Table 144](#).

**Figure 177. Number of Available Entries in LUT Register (DFC\_SIZ)**



LEGEND: R/W = Read/Write; R = Read only; -n = value after reset

**Table 144. Number of Available Entries in LUT Register (DFC\_SIZ) Field Descriptions**

Bit	Field	Value	Description
15-10	Reserved	0	Reserved
9-0	SIZ	0-3FFh	Number of valid data in LUT.

### 6.3.23 2D Noise Filter Enable Register (D2F\_EN)

The 2D noise filter enable register (D2F\_EN) is shown in [Figure 178](#) and described in [Table 145](#).

**Figure 178. 2D Noise Filter Enable Register (D2F\_EN)**

15	1	0
Reserved	EN	
R-0	R/W-0	

LEGEND: R/W = Read/Write; R = Read only; -n = value after reset

**Table 145. 2D Noise Filter Enable Register (D2F\_EN) Field Descriptions**

Bit	Field	Value	Description
15-1	Reserved	0	Reserved.
0	SEL	0	Noise filter enable.
		0	Disable.
		1	Enable.

### 6.3.24 Noise Filter Configuration Register (D2F\_CFG)

The noise filter configuration register (D2F\_CFG) is shown in [Figure 179](#) and described in [Table 146](#).

**Figure 179. Noise Filter Configuration Register (D2F\_CFG)**

15	4	3	2	1	0
Reserved	TYP	SHF	SPR		
R-0	R/W-0	R/W-0	R/W-0		

LEGEND: R/W = Read/Write; R = Read only; -n = value after reset

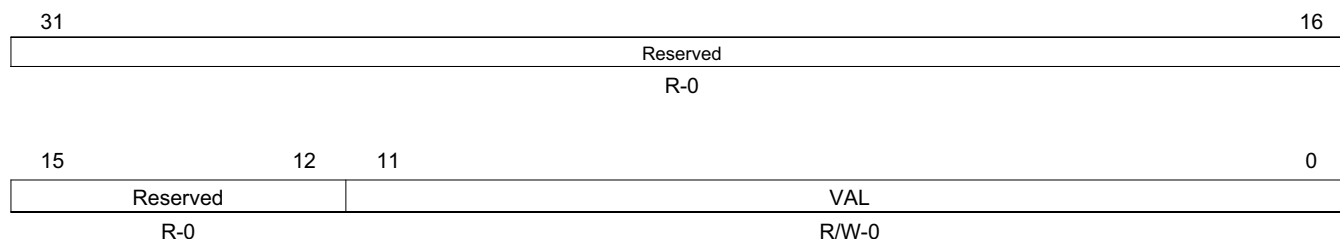
**Table 146. Noise Filter Configuration Register (D2F\_CFG) Field Descriptions**

Bit	Field	Value	Description
15-5	Reserved	0	Reserved.
4	TYP	0	Sampling method of green pixels.
		0	Box (same as R or B).
		1	Diamond mode.
3-2	SHF	0-3	Down shift value in LUT reference address.
1-0	SPR	0-3	Spread value in noise filter algorithm.

### 6.3.25 Noise Filter LUT Values (Threshold) Register (D2F\_THR[32])

The noise filter LUT values (Threshold) register (D2F\_THR[32]) is shown in [Figure 180](#) and described in [Table 147](#).

**Figure 180. Noise Filter LUT Values (Threshold) Register (D2F\_THR[32])**



LEGEND: R/W = Read/Write; R = Read only; -n = value after reset

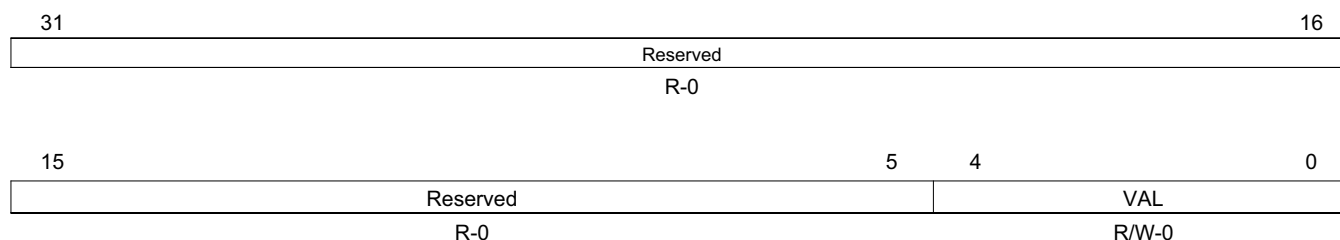
**Table 147. Noise Filter LUT Values (Threshold) Register (D2F\_THR[32]) Field Descriptions**

Bit	Field	Value	Description
31-12	Reserved	0	Reserved.
11-0	VAL	0-FFFh	Threshold value in noise filter algorithm.

### 6.3.26 Noise Filter LUT Values (Intensity) Register (D2F\_STR[32])

The noise filter LUT values (Intensity) register (D2F\_STR[32]) is shown in [Figure 181](#) and described in [Table 148](#).

**Figure 181. Noise Filter LUT Values (Intensity) Register (D2F\_STR[32])**



LEGEND: R/W = Read/Write; R = Read only; -n = value after reset

**Table 148. Noise Filter LUT Values (Intensity) Register (D2F\_STR[32]) Field Descriptions**

Bit	Field	Value	Description
31-5	Reserved	0	Reserved.
4-0	VAL	0-1Fh	Intensity value in noise filter algorithm. VAL needs to be equal to or less than 32.



### 6.3.27 PreFilter Enable Register (PRE\_EN)

The PreFilter enable register (PRE\_EN) is shown in [Figure 182](#) and described in [Table 149](#).

**Figure 182. PreFilter Enable Register (PRE\_EN)**

15	Reserved	1	0
	R-0		EN R/W-0

LEGEND: R/W = Read/Write; R = Read only; -n = value after reset

**Table 149. PreFilter Enable Register (PRE\_EN) Field Descriptions**

Bit	Field	Value	Description
15-1	Reserved	0	Reserved.
0	EN		PreFilter enable.
		0	Disable.
		1	Enable.

### 6.3.28 PreFilter Type Register (PRE\_TYP)

The PreFilter type register (PRE\_TYP) is shown in [Figure 183](#) and described in [Table 150](#).

**Figure 183. PreFilter Type Register (PRE\_TYP)**

15	Reserved	4	3	2	1	0
	R-0		EN1 R/W-0	EN0 R/W-0	SEL1 R/W-0	SEL0 R/W-0

LEGEND: R/W = Read/Write; R = Read only; -n = value after reset

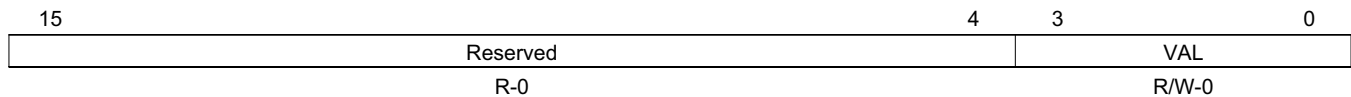
**Table 150. PreFilter Type Register (PRE\_TYP) Field Descriptions**

Bit	Field	Value	Description
15-4	Reserved	0	Reserved.
3	EN1		Enable of Adaptive DotReduction.
		0	(DISABLE) only prefilter is applied.
		1	(ENABLE) DotReduction is applied after prefilter.
2	EN0		Enable of Adaptive PreFilter.
		0	(DISABLE) constant gain.
		1	(ENABLE) adaptive gain control.
1	SEL1		Averaging Method GS1 in PreFilter.
		0	(AVG4PIX) average of 4 pixels.
		1	(AVG2MEDPIX) average of 2 median pixels.
0	SEL0		Averaging Method GS2 in PreFilter.
		0	(AVG4PIX) average of 4 pixels.
		1	(AVG2MEDPIX) average of 2 median pixels.

### 6.3.29 Shift Value of Adaptive Gain Register (PRE\_SHF)

The shift value of adaptive gain register (PRE\_SHF) is shown in [Figure 184](#) and described in [Table 151](#).

**Figure 184. Shift Value of Adaptive Gain Register (PRE\_SHF)**



LEGEND: R/W = Read/Write; R = Read only; -n = value after reset

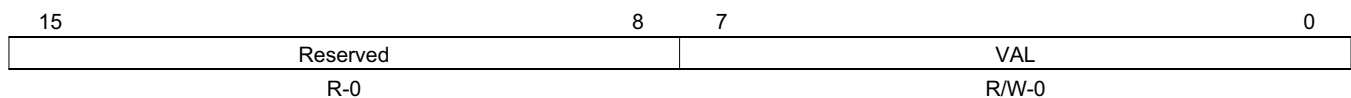
**Table 151. Shift Value of Adaptive Gain Register (PRE\_SHF) Field Descriptions**

Bit	Field	Value	Description
15-4	Reserved	0	Reserved.
3-0	VAL	0-Fh	Downshift value in adaptive PreFilter algorithm.

### 6.3.30 Constant Gain or Adaptive Gain Slope Register (PRE\_GAIN)

The constant gain or adaptive gain slope register (PRE\_GAIN) is shown in [Figure 185](#) and described in [Table 152](#).

**Figure 185. Constant Gain or Adaptive Gain Slope Register (PRE\_GAIN)**



LEGEND: R/W = Read/Write; R = Read only; -n = value after reset

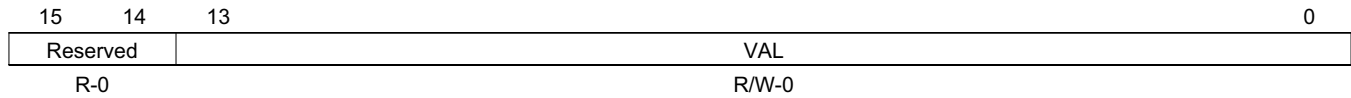
**Table 152. Constant Gain or Adaptive Gain Slope Register (PRE\_GAIN) Field Descriptions**

Bit	Field	Value	Description
15-8	Reserved	0	Reserved.
7-0	VAL	0-FFh	Constant gain or adaptive gain slope. In constant gain mode (PRE_TYP[EN0]=0), VAL specifies the PreFilter gain. In adaptive PreFilter mode (PRE_TYP[EN0]=1), VAL specifies the slope in gain function.

### 6.3.31 Threshold G Register (PRE\_THR\_G)

The threshold G register (PRE\_THR\_G) is shown in [Figure 186](#) and described in [Table 153](#).

**Figure 186. Threshold G Register (PRE\_THR\_G)**



LEGEND: R/W = Read/Write; R = Read only; -n = value after reset

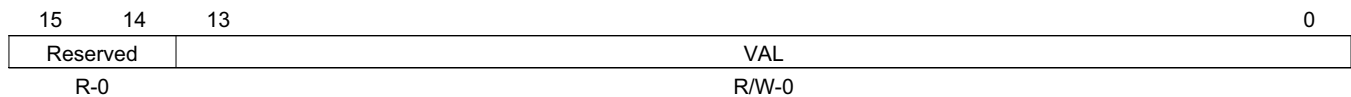
**Table 153. Threshold G Register (PRE\_THR\_G) Field Descriptions**

Bit	Field	Value	Description
15-14	Reserved	0	Reserved.
13-0	VAL	0-3FFFh	Threshold (ThrG) in the adaptive PreFilter algorithm.

### 6.3.32 Threshold B Register (PRE\_THR\_B)

The threshold B register (PRE\_THR\_B) is shown in [Figure 187](#) and described in [Table 154](#).

**Figure 187. Threshold B Register (PRE\_THR\_B)**



LEGEND: R/W = Read/Write; R = Read only; -n = value after reset

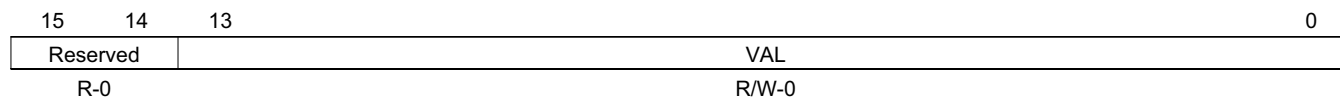
**Table 154. Threshold B Register (PRE\_THR\_B) Field Descriptions**

Bit	Field	Value	Description
15-14	Reserved	0	Reserved.
13-0	VAL	0-3FFFh	Threshold (ThrB) in the DotReduction.

### 6.3.33 Threshold 1 Register (PRE\_THR\_1)

The threshold 1 register (PRE\_THR\_1) is shown in [Figure 188](#) and described in [Table 155](#).

**Figure 188. Threshold 1 Register (PRE\_THR\_1)**



LEGEND: R/W = Read/Write; R = Read only; -n = value after reset

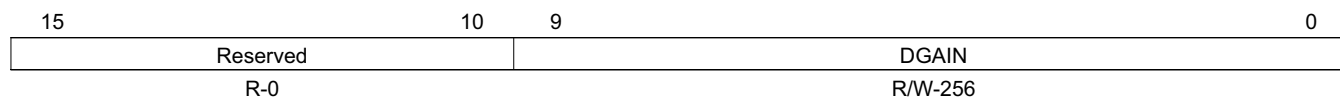
**Table 155. Threshold 1 Register (PRE\_THR\_1) Field Descriptions**

Bit	Field	Value	Description
15-14	Reserved	0	Reserved.
13-0	VAL	0-3FFFh	Threshold (Thr1) in the adaptive PreFilter algorithm.

### 6.3.34 Digital Gain Register (WB2\_DGN)

The digital gain register (WB2\_DGN) is shown in [Figure 189](#) and described in [Table 156](#).

**Figure 189. Digital Gain Register (WB2\_DGN)**



LEGEND: R/W = Read/Write; R = Read only; -n = value after reset

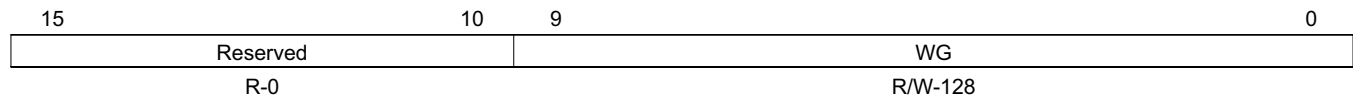
**Table 156. Digital Gain Register (WB2\_DGN) Field Descriptions**

Bit	Field	Value	Description
15-10	Reserved	0	Reserved.
9-0	DGAIN	0-3FFh	Digital Gain. Value is in U10Q8.

### 6.3.35 White Balance Gain (Red) Register (WB2\_WG\_R)

The white balance gain (Red) register (WB2\_WG\_R) is shown in [Figure 190](#) and described in [Table 157](#).

**Figure 190. White Balance Gain (Red) Register (WB2\_WG\_R)**



LEGEND: R/W = Read/Write; R = Read only; -n = value after reset

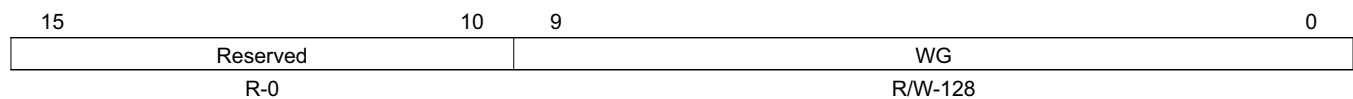
**Table 157. White Balance Gain (Red) Register (WB2\_WG\_R) Field Descriptions**

Bit	Field	Value	Description
15-10	Reserved	0	Reserved.
9-0	WG	0-3FFh	Red gain. Value is in U10Q7.

### 6.3.36 White Balance Gain (Gr) Register (WB2\_WG\_GR)

The white balance gain (Gr) register (WB2\_WG\_GR) is shown in [Figure 191](#) and described in [Table 158](#).

**Figure 191. White Balance Gain (Gr) Register (WB2\_WG\_GR)**



LEGEND: R/W = Read/Write; R = Read only; -n = value after reset

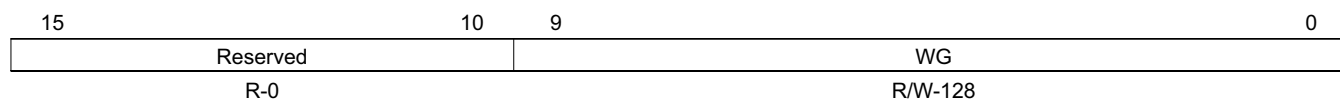
**Table 158. White Balance Gain (Gr) Register (WB2\_WG\_GR) Field Descriptions**

Bit	Field	Value	Description
15-10	Reserved	0	Reserved.
9-0	WG	0-3FFh	Gr gain. Value is in U10Q7.

### 6.3.37 White Balance Gain (Gb) Register (WB2\_WG\_GB)

The white balance gain (Gb) register (WB2\_WG\_GB) is shown in [Figure 192](#) and described in [Table 159](#).

**Figure 192. White Balance Gain (Gb) Register (WB2\_WG\_GB)**



LEGEND: R/W = Read/Write; R = Read only; -n = value after reset

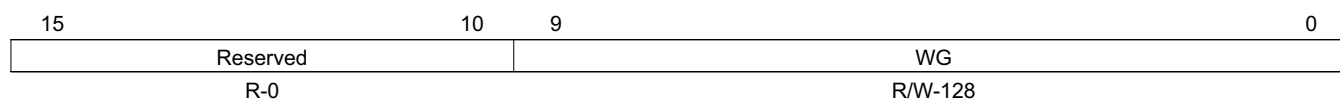
**Table 159. White Balance Gain (Gb) Register (WB2\_WG\_GB) Field Descriptions**

Bit	Field	Value	Description
15-10	Reserved	0	Reserved.
9-0	WG	0-3FFh	Gb gain. Value is in U10Q7.

### 6.3.38 White Balance Gain (Blue) Register (WB2\_WG\_B)

The white balance gain (Blue) register (WB2\_WG\_B) is shown in [Figure 193](#) and described in [Table 160](#).

**Figure 193. White Balance Gain (Blue) Register (WB2\_WG\_B)**



LEGEND: R/W = Read/Write; R = Read only; -n = value after reset

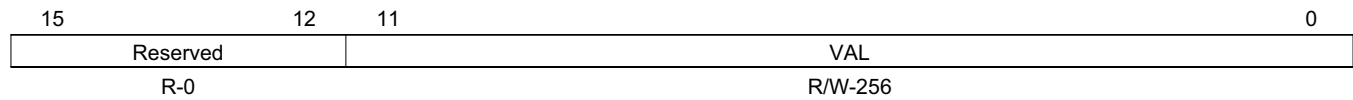
**Table 160. White Balance Gain (Blue) Register (WB2\_WG\_B) Field Descriptions**

Bit	Field	Value	Description
15-10	Reserved	0	Reserved.
9-0	WG	0-3FFh	Blue gain. Value is in U10Q7.

### 6.3.39 Matrix Coefficient RR Register (RGB\_MUL\_RR)

The matrix coefficient RR register (RGB\_MUL\_RR) is shown in [Figure 194](#) and described in [Table 161](#).

**Figure 194. Matrix Coefficient RR Register (RGB\_MUL\_RR)**



LEGEND: R/W = Read/Write; R = Read only; -n = value after reset

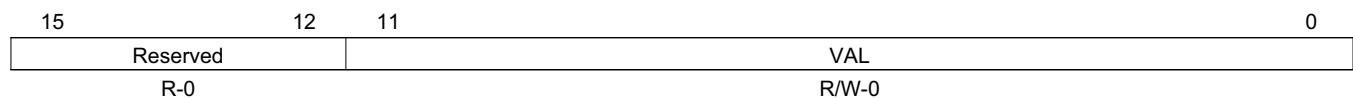
**Table 161. Matrix Coefficient RR Register (RGB\_MUL\_RR) Field Descriptions**

Bit	Field	Value	Description
15-12	Reserved	0	Reserved.
11-0	VAL	0-FFFh	Matrix coefficient RR. Value is in S12Q8.

### 6.3.40 Matrix Coefficient GR Register (RGB\_MUL\_GR)

The matrix coefficient GR register (RGB\_MUL\_GR) is shown in [Figure 195](#) and described in [Table 162](#).

**Figure 195. Matrix Coefficient GR Register (RGB\_MUL\_GR)**



LEGEND: R/W = Read/Write; R = Read only; -n = value after reset

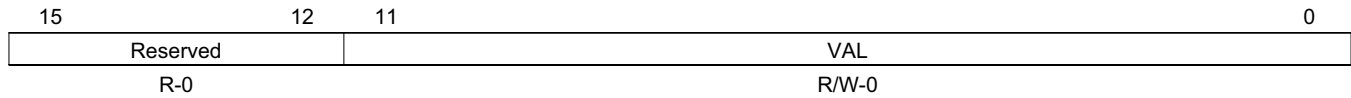
**Table 162. Matrix Coefficient GR Register (RGB\_MUL\_GR) Field Descriptions**

Bit	Field	Value	Description
15-12	Reserved	0	Reserved.
11-0	VAL	0-FFFh	Matrix coefficient GR. Value is in S12Q8.

### 6.3.41 Matrix Coefficient BR Register (RGB\_MUL\_BR)

The matrix coefficient BR register (RGB\_MUL\_BR) is shown in [Figure 196](#) and described in [Table 163](#).

**Figure 196. Matrix Coefficient BR Register (RGB\_MUL\_BR)**



LEGEND: R/W = Read/Write; R = Read only; -n = value after reset

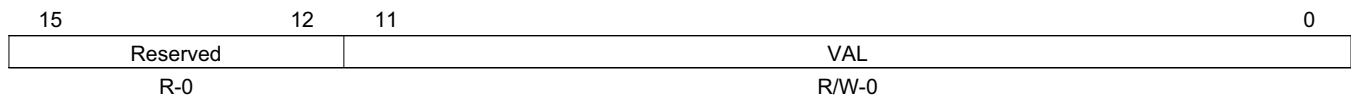
**Table 163. Matrix Coefficient BR Register (RGB\_MUL\_BR) Field Descriptions**

Bit	Field	Value	Description
15-12	Reserved	0	Reserved.
11-0	VAL	0-FFFh	Matrix coefficient BR. Value is in S12Q8.

### 6.3.42 Matrix Coefficient RG Register (RGB\_MUL\_RG)

The matrix coefficient RG register (RGB\_MUL\_RG) is shown in [Figure 197](#) and described in [Table 164](#).

**Figure 197. Matrix Coefficient RG Register (RGB\_MUL\_RG)**



LEGEND: R/W = Read/Write; R = Read only; -n = value after reset

**Table 164. Matrix Coefficient RG Register (RGB\_MUL\_RG) Field Descriptions**

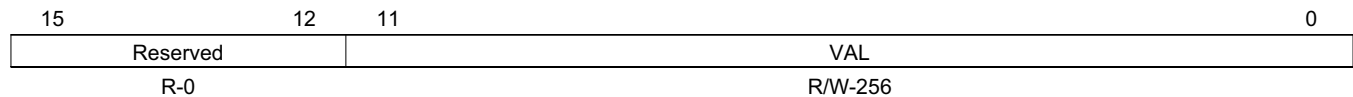
Bit	Field	Value	Description
15-12	Reserved	0	Reserved.
11-0	VAL	0-FFFh	Matrix coefficient RG. Value is in S12Q8.



### 6.3.43 Matrix Coefficient GG Register (RGB\_MUL\_GG)

The matrix coefficient GG register (RGB\_MUL\_GG) is shown in [Figure 198](#) and described in [Table 165](#).

**Figure 198. Matrix Coefficient GG Register (RGB\_MUL\_GG)**



LEGEND: R/W = Read/Write; R = Read only; -n = value after reset

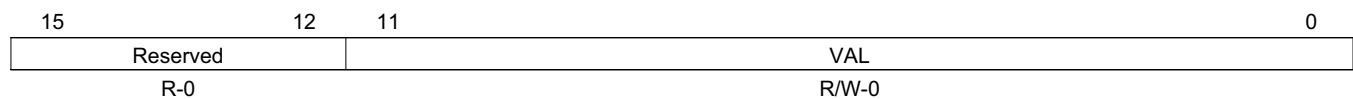
**Table 165. Matrix Coefficient GG Register (RGB\_MUL\_GG) Field Descriptions**

Bit	Field	Value	Description
15-12	Reserved	0	Reserved.
11-0	VAL	0-FFFh	Matrix coefficient GG. Value is in S12Q8.

### 6.3.44 Matrix Coefficient BG Register (RGB\_MUL\_BG)

The matrix coefficient BG register (RGB\_MUL\_BG) is shown in [Figure 199](#) and described in [Table 166](#).

**Figure 199. Matrix Coefficient BG Register (RGB\_MUL\_BG)**



LEGEND: R/W = Read/Write; R = Read only; -n = value after reset

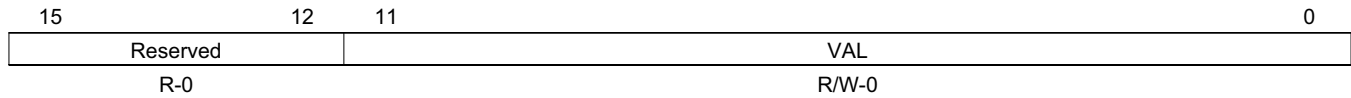
**Table 166. Matrix Coefficient BG Register (RGB\_MUL\_BG) Field Descriptions**

Bit	Field	Value	Description
15-12	Reserved	0	Reserved.
11-0	VAL	0-FFFh	Matrix coefficient BG. Value is in S12Q8.

### 6.3.45 Matrix Coefficient RB Register (RGB\_MUL\_RB)

The matrix coefficient RB register (RGB\_MUL\_RB) is shown in [Figure 200](#) and described in [Table 167](#).

**Figure 200. Matrix Coefficient RB Register (RGB\_MUL\_RB)**



LEGEND: R/W = Read/Write; R = Read only; -n = value after reset

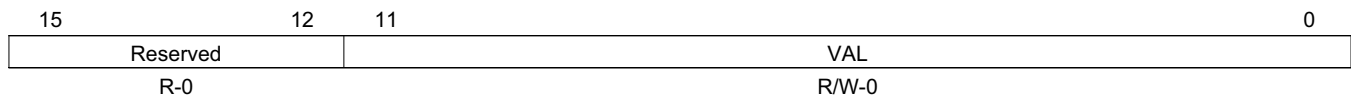
**Table 167. Matrix Coefficient RB Register (RGB\_MUL\_RB) Field Descriptions**

Bit	Field	Value	Description
15-12	Reserved	0	Reserved.
11-0	VAL	0-FFFh	Matrix coefficient RB. Value is in S12Q8.

### 6.3.46 Matrix Coefficient GB Register (RGB\_MUL\_GB)

The matrix coefficient GB register (RGB\_MUL\_GB) is shown in [Figure 201](#) and described in [Table 168](#).

**Figure 201. Matrix Coefficient GB Register (RGB\_MUL\_GB)**



LEGEND: R/W = Read/Write; R = Read only; -n = value after reset

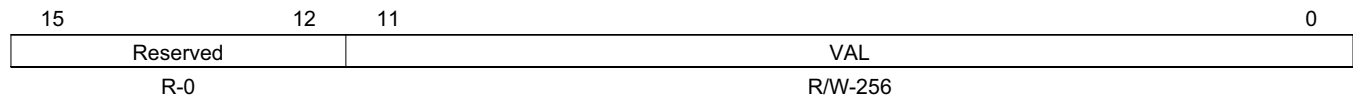
**Table 168. Matrix Coefficient GB Register (RGB\_MUL\_GB) Field Descriptions**

Bit	Field	Value	Description
15-12	Reserved	0	Reserved.
11-0	VAL	0-FFFh	Matrix coefficient GB. Value is in S12Q8.

### 6.3.47 Matrix Coefficient BB Register (RGB\_MUL\_BB)

The matrix coefficient BB register (RGB\_MUL\_BB) is shown in [Figure 202](#) and described in [Table 169](#).

**Figure 202. Matrix Coefficient BB Register (RGB\_MUL\_BB)**



LEGEND: R/W = Read/Write; R = Read only; -n = value after reset

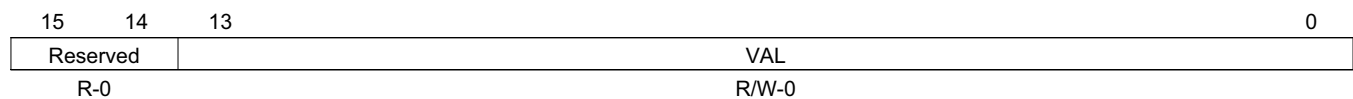
**Table 169. Matrix Coefficient BB Register (RGB\_MUL\_BB) Field Descriptions**

Bit	Field	Value	Description
15-12	Reserved	0	Reserved.
11-0	VAL	0-FFFh	Matrix coefficient BB. Value is in S12Q8.

### 6.3.48 R Output Offset Register (RGB\_OFT\_OR)

The R output offset register (RGB\_OFT\_OR) is shown in [Figure 203](#) and described in [Table 170](#).

**Figure 203. R Output Offset Register (RGB\_OFT\_OR)**



LEGEND: R/W = Read/Write; R = Read only; -n = value after reset

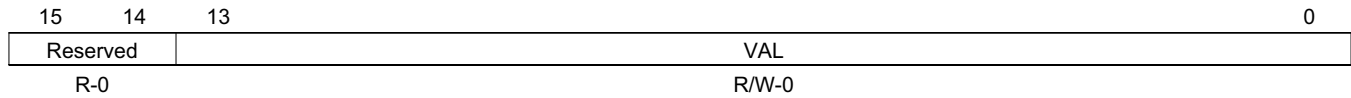
**Table 170. R Output Offset Register (RGB\_OFT\_OR) Field Descriptions**

Bit	Field	Value	Description
15-14	Reserved	0	Reserved.
13-0	VAL	0-3FFFh	Output offset value for R. Value is in S14Q0.

### 6.3.49 G Output Offset Register (RGB\_OFT\_OG)

The G output offset register (RGB\_OFT\_OG) is shown in [Figure 204](#) and described in [Table 171](#).

**Figure 204. G Output Offset Register (RGB\_OFT\_OG)**



LEGEND: R/W = Read/Write; R = Read only; -n = value after reset

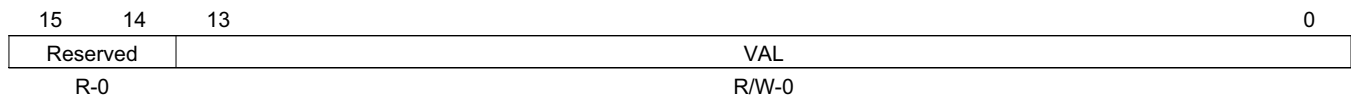
**Table 171. G Output Offset Register (RGB\_OFT\_OG) Field Descriptions**

Bit	Field	Value	Description
15-14	Reserved	0	Reserved.
13-0	VAL	0-3FFFh	Output offset value for G. Value is in S14Q0.

### 6.3.50 B Output Offset Register (RGB\_OFT\_OB)

The B output offset register (RGB\_OFT\_OB) is shown in [Figure 205](#) and described in [Table 172](#).

**Figure 205. B Output Offset Register (RGB\_OFT\_OB)**



LEGEND: R/W = Read/Write; R = Read only; -n = value after reset

**Table 172. B Output Offset Register (RGB\_OFT\_OB) Field Descriptions**

Bit	Field	Value	Description
15-14	Reserved	0	Reserved.
13-0	VAL	0-3FFFh	Output offset value for B. Value is in S14Q0.

### 6.3.51 Gamma Correction Configuration Register (GMM\_CFG)

The gamma correction configuration register (GMM\_CFG) is shown in [Figure 206](#) and described in [Table 173](#).

**Figure 206. Gamma Correction Configuration Register (GMM\_CFG)**

15	7	6	5	4	3	2	1	0
Reserved		SIZ	TBL	Reserved	BYPB	BYPG	BYPR	
R-0		R/W-3	R/W-0	R-0	R/W-1	R/W-1	R/W-1	

LEGEND: R/W = Read/Write; R = Read only; -n = value after reset

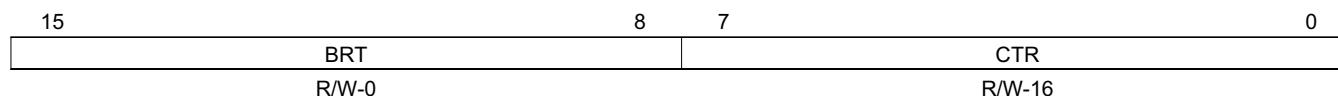
**Table 173. Gamma Correction Configuration Register (GMM\_CFG) Field Descriptions**

Bit	Field	Value	Description
15-7	Reserved	0	Reserved.
6-5	SIZ	0	128 words.
		1	256 words.
		2	Reserved.
		3	512 words.
4	TBL	0	RAM.
		1	ROM.
3	Reserved	0	Reserved.
2	BYPB	0	Gamma correction mode for B. Not bypass.
		1	Bypass.
1	BYPG	0	Gamma correction mode for G. Not bypass.
		1	Bypass.
0	BYPR	0	Gamma correction mode for R. Not bypass.
		1	Bypass.

### 6.3.52 Luminance Adjustment (Contrast and Brightness) Register (YCC\_ADJ)

The luminance adjustment (contrast and brightness) register (YCC\_ADJ) is shown in [Figure 207](#) and described in [Table 174](#).

**Figure 207. Luminance Adjustment (Contrast and Brightness) Register (YCC\_ADJ)**



LEGEND: R/W = Read/Write; -n = value after reset

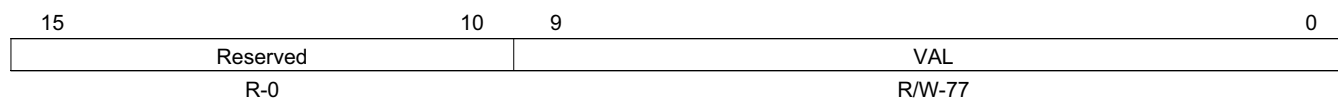
**Table 174. Luminance Adjustment (Contrast and Brightness) Register (YCC\_ADJ) Field Descriptions**

Bit	Field	Value	Description
15-8	BRT	0-FFh	Brightness. Offset value for brightness control.
7-0	CTR	0-FFh	Contrast. Multiplier coefficient for contrast control. Value is in U8Q4.

### 6.3.53 Matrix Coefficient RY Register (YCC\_MUL\_RY)

The matrix coefficient RY register (YCC\_MUL\_RY) is shown in [Figure 208](#) and described in [Table 175](#).

**Figure 208. Matrix Coefficient RY Register (YCC\_MUL\_RY)**



LEGEND: R/W = Read/Write; R = Read only; -n = value after reset

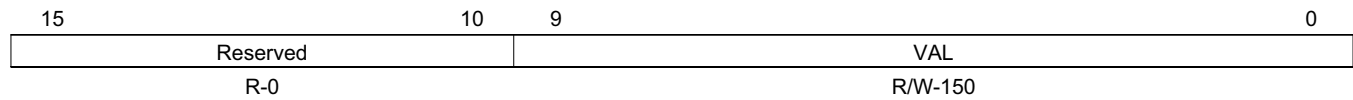
**Table 175. Matrix Coefficient RY Register (YCC\_MUL\_RY) Field Descriptions**

Bit	Field	Value	Description
15-10	Reserved	0	Reserved.
9-0	VAL	0-3FFh	Matrix coefficient for RY. Value is in S10Q8.

### 6.3.54 Matrix Coefficient GY Register (YCC\_MUL\_GY)

The matrix coefficient GY register (YCC\_MUL\_GY) is shown in [Figure 209](#) and described in [Table 176](#).

**Figure 209. Matrix Coefficient GY Register (YCC\_MUL\_GY)**



LEGEND: R/W = Read/Write; R = Read only; -n = value after reset

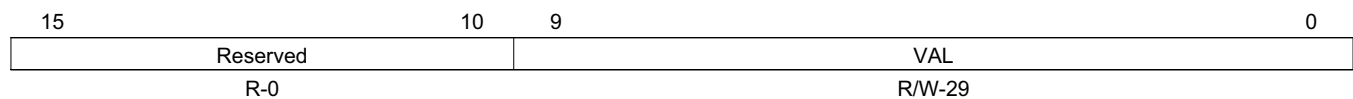
**Table 176. Matrix Coefficient GY Register (YCC\_MUL\_GY) Field Descriptions**

Bit	Field	Value	Description
15-10	Reserved	0	Reserved.
9-0	VAL	0-3FFh	Matrix coefficient for GY. Value is in S10Q8.

### 6.3.55 Matrix Coefficient BY Register (YCC\_MUL\_BY)

The matrix coefficient BY register (YCC\_MUL\_BY) is shown in [Figure 210](#) and described in [Table 177](#).

**Figure 210. Matrix Coefficient BY Register (YCC\_MUL\_BY)**



LEGEND: R/W = Read/Write; R = Read only; -n = value after reset

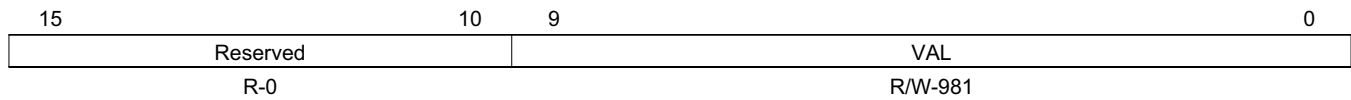
**Table 177. Matrix Coefficient BY Register (YCC\_MUL\_BY) Field Descriptions**

Bit	Field	Value	Description
15-10	Reserved	0	Reserved.
9-0	VAL	0-3FFh	Matrix coefficient for BY. Value is in S10Q8.

### 6.3.56 Matrix Coefficient RCb Register (YCC\_MUL\_RCB)

The matrix coefficient RCb register (YCC\_MUL\_RCB) is shown in [Figure 211](#) and described in [Table 178](#).

**Figure 211. Matrix Coefficient RCb Register (YCC\_MUL\_RCB)**



LEGEND: R/W = Read/Write; R = Read only; -n = value after reset

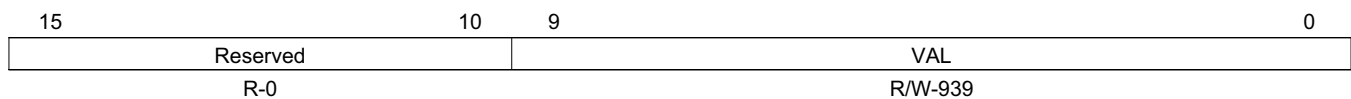
**Table 178. Matrix Coefficient RCb Register (YCC\_MUL\_RCB) Field Descriptions**

Bit	Field	Value	Description
15-10	Reserved	0	Reserved.
9-0	VAL	0-3FFh	Matrix coefficient for RCb. Value is in S10Q8.

### 6.3.57 Matrix Coefficient GCb Register (YCC\_MUL\_GCB)

The matrix coefficient GCb register (YCC\_MUL\_GCB) is shown in [Figure 212](#) and described in [Table 179](#).

**Figure 212. Matrix Coefficient GCb Register (YCC\_MUL\_GCB)**



LEGEND: R/W = Read/Write; R = Read only; -n = value after reset

**Table 179. Matrix Coefficient GCb Register (YCC\_MUL\_GCB) Field Descriptions**

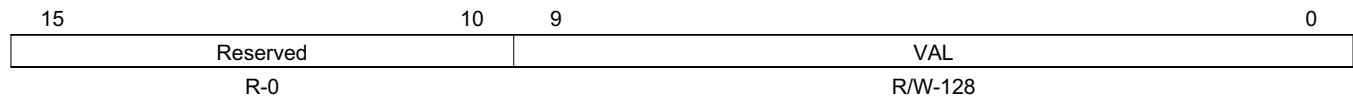
Bit	Field	Value	Description
15-10	Reserved	0	Reserved.
9-0	VAL	0-3FFh	Matrix coefficient for GCb. Value is in S10Q8.



### 6.3.58 Matrix Coefficient BCb Register (YCC\_MUL\_BCB)

The matrix coefficient BCb register (YCC\_MUL\_BCB) is shown in [Figure 213](#) and described in [Table 180](#).

**Figure 213. Matrix Coefficient BCb Register (YCC\_MUL\_BCB)**



LEGEND: R/W = Read/Write; R = Read only; -n = value after reset

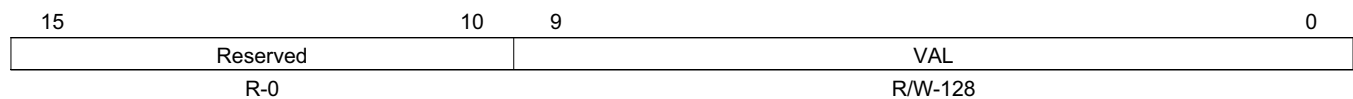
**Table 180. Matrix Coefficient BCb Register (YCC\_MUL\_BCB) Field Descriptions**

Bit	Field	Value	Description
15-10	Reserved	0	Reserved.
9-0	VAL	0-3FFh	Matrix coefficient for BCb. Value is in S10Q8.

### 6.3.59 Matrix Coefficient RCr Register (YCC\_MUL\_RCR)

The matrix coefficient RCr register (YCC\_MUL\_RCR) is shown in [Figure 214](#) and described in [Table 181](#).

**Figure 214. Matrix Coefficient RCr Register (YCC\_MUL\_RCR)**



LEGEND: R/W = Read/Write; R = Read only; -n = value after reset

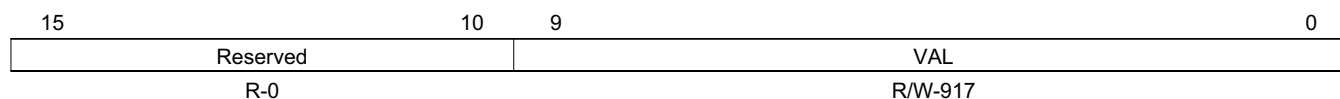
**Table 181. Matrix Coefficient RCr Register (YCC\_MUL\_RCR) Field Descriptions**

Bit	Field	Value	Description
15-10	Reserved	0	Reserved.
9-0	VAL	0-3FFh	Matrix coefficient for RCr. Value is in S10Q8.

### 6.3.60 Matrix Coefficient GCr Register (YCC\_MUL\_GCR)

The matrix coefficient GCr register (YCC\_MUL\_GCR) is shown in [Figure 215](#) and described in [Table 182](#).

**Figure 215. Matrix Coefficient GCr Register (YCC\_MUL\_GCR)**



LEGEND: R/W = Read/Write; R = Read only; -n = value after reset

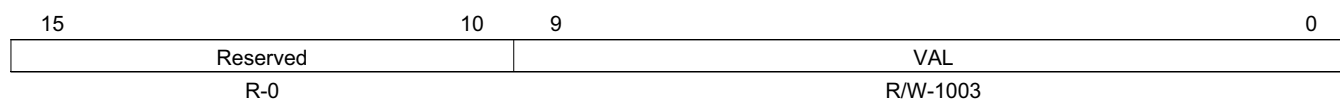
**Table 182. Matrix Coefficient GCr Register (YCC\_MUL\_GCR) Field Descriptions**

Bit	Field	Value	Description
15-10	Reserved	0	Reserved.
9-0	VAL	0-3FFh	Matrix coefficient for GCr. Value is in S10Q8.

### 6.3.61 Matrix Coefficient BCr Register (YCC\_MUL\_BCR)

The matrix coefficient BCr register (YCC\_MUL\_BCR) is shown in [Figure 216](#) and described in [Table 183](#).

**Figure 216. Matrix Coefficient BCr Register (YCC\_MUL\_BCR)**



LEGEND: R/W = Read/Write; R = Read only; -n = value after reset

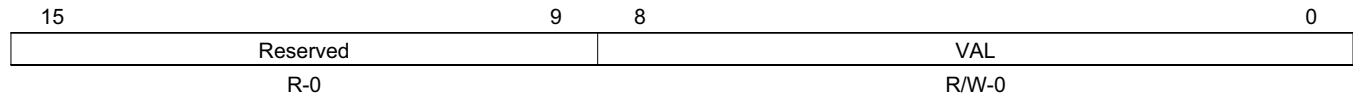
**Table 183. Matrix Coefficient BCr Register (YCC\_MUL\_BCR) Field Descriptions**

Bit	Field	Value	Description
15-10	Reserved	0	Reserved.
9-0	VAL	0-3FFh	Matrix coefficient for BCr. Value is in S10Q8.

### 6.3.62 Y Output Offset Register (YCC\_OFT\_Y)

The Y output offset register (YCC\_OFT\_Y) is shown in [Figure 217](#) and described in [Table 184](#).

**Figure 217. Y Output Offset Register (YCC\_OFT\_Y)**



LEGEND: R/W = Read/Write; R = Read only; -n = value after reset

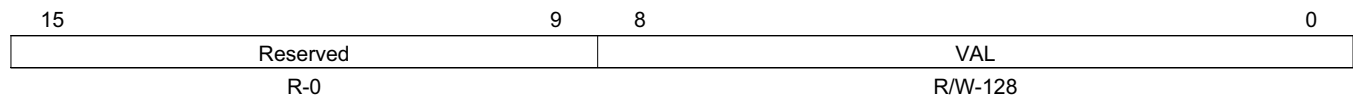
**Table 184. Y Output Offset Register (YCC\_OFT\_Y) Field Descriptions**

Bit	Field	Value	Description
15-9	Reserved	0	Reserved
8-0	VAL	0-1FFh	Y output offset. Value is in S9Q0.

### 6.3.63 Cb Output Offset Register (YCC\_OFT\_CB)

The Cb output offset register (YCC\_OFT\_CB) is shown in [Figure 218](#) and described in [Table 185](#).

**Figure 218. Cb Output Offset Register (YCC\_OFT\_CB)**



LEGEND: R/W = Read/Write; R = Read only; -n = value after reset

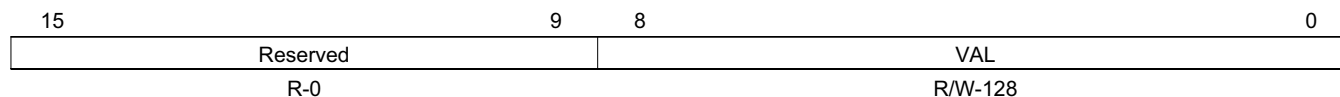
**Table 185. Cb Output Offset Register (YCC\_OFT\_CB) Field Descriptions**

Bit	Field	Value	Description
15-9	Reserved	0	Reserved
8-0	VAL	0-1FFh	Cb output offset. Value is in S9Q0.

### 6.3.64 Cr Output Offset Register (YCC\_OFT\_CR)

The Cr output offset register (YCC\_OFT\_CR) is shown in [Figure 219](#) and described in [Table 186](#).

**Figure 219. Cr Output Offset Register (YCC\_OFT\_CR)**



LEGEND: R/W = Read/Write; R = Read only; -n = value after reset

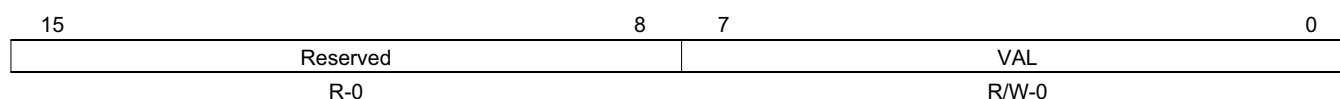
**Table 186. Cr Output Offset Register (YCC\_OFT\_CR) Field Descriptions**

Bit	Field	Value	Description
15-9	Reserved	0	Reserved
8-0	VAL	0-1FFh	Cr output offset. Value is in S9Q0.

### 6.3.65 Saturation (Luminance Minimum) Register (YCC\_Y\_MIN)

The saturation (luminance minimum) register (YCC\_Y\_MIN) is shown in [Figure 220](#) and described in [Table 187](#).

**Figure 220. Saturation (Luminance Minimum) Register (YCC\_Y\_MIN)**



LEGEND: R/W = Read/Write; R = Read only; -n = value after reset

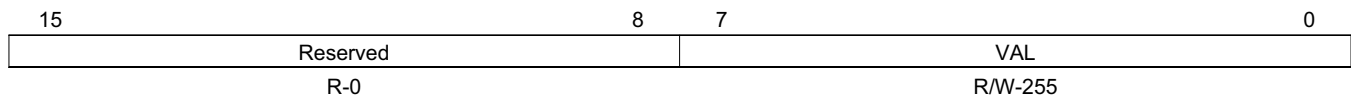
**Table 187. Saturation (Luminance Minimum) Register (YCC\_Y\_MIN) Field Descriptions**

Bit	Field	Value	Description
15-8	Reserved	0	Reserved
7-0	VAL	0-FFh	Minimum luminance value.

### 6.3.66 Saturation (Luminance Maximum) Register (YCC\_Y\_MAX)

The saturation (luminance maximum) register (YCC\_Y\_MAX) is shown in [Figure 221](#) and described in [Table 188](#).

**Figure 221. Saturation (Luminance Maximum) Register (YCC\_Y\_MAX)**



LEGEND: R/W = Read/Write; R = Read only; -n = value after reset

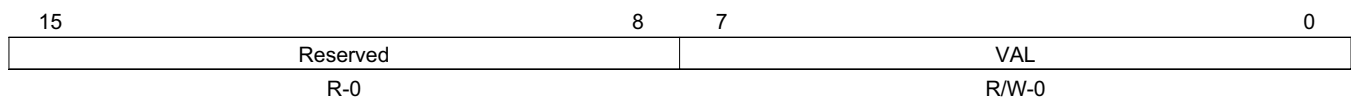
**Table 188. Saturation (Luminance Maximum) Register (YCC\_Y\_MAX) Field Descriptions**

Bit	Field	Value	Description
15-8	Reserved	0	Reserved
7-0	VAL	0-FFh	Maximum luminance value.

### 6.3.67 Saturation (Chrominance Minimum) Register (YCC\_C\_MIN)

The saturation (chrominance minimum) register (YCC\_C\_MIN) is shown in [Figure 222](#) and described in [Table 189](#).

**Figure 222. Saturation (Chrominance Minimum) Register (YCC\_C\_MIN)**



LEGEND: R/W = Read/Write; R = Read only; -n = value after reset

**Table 189. Saturation (Chrominance Minimum) Register (YCC\_C\_MIN) Field Descriptions**

Bit	Field	Value	Description
15-8	Reserved	0	Reserved
7-0	VAL	0-FFh	Minimum chrominance value.

### 6.3.68 Saturation (Chrominance Maximum) Register (YCC\_C\_MAX)

The saturation (chrominance maximum) register (YCC\_C\_MAX) is shown in [Figure 223](#) and described in [Table 190](#).

**Figure 223. Saturation (Chrominance Maximum) Register (YCC\_C\_MAX)**

15	8	7	0
Reserved		VAL	
R-0		R/W-255	

LEGEND: R/W = Read/Write; R = Read only; -n = value after reset

**Table 190. Saturation (Chrominance Maximum) Register (YCC\_C\_MAX) Field Descriptions**

Bit	Field	Value	Description
15-8	Reserved	0	Reserved
7-0	VAL	0-FFh	Maximum chrominance value.

### 6.3.69 Chrominance Position (for 422 Down Sampler) Register (YCC\_PHS)

The chrominance position (for 422 down sampler) register (YCC\_PHS) is shown in [Figure 224](#) and described in [Table 191](#).

**Figure 224. Chrominance Position (for 422 Down Sampler) Register (YCC\_PHS)**

15	1	0
Reserved		LPF
R-0		SEL
		R/W-0 R/W-0

LEGEND: R/W = Read/Write; R = Read only; -n = value after reset

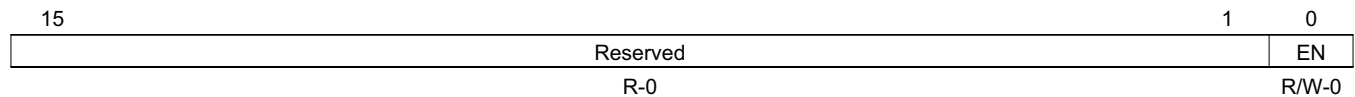
**Table 191. Chrominance Position (for 422 down sampler) Register (YCC\_PHS) Field Descriptions**

Bit	Field	Value	Description
15-2	Reserved	0	Reserved.
1	LPF	0	121_LPF enable for chrominance.
		0	Off.
		1	On.
0	POS		Phase position of the output of the chrominance. If IPIPE_DPATHS = 3 (YCbCr input), then the phase position of the INPUT of the Chrominance is selected by this register.
		0	(COSITING) same position with luminance.
		1	(CENTERING) the middle of the luminance.

### 6.3.70 Edge Enhancer Enable Register (YEE\_EN)

The edge enhancer enable register (YEE\_EN) is shown in [Figure 225](#) and described in [Table 192](#).

**Figure 225. Edge Enhancer Enable Register (YEE\_EN)**



LEGEND: R/W = Read/Write; R = Read only; -n = value after reset

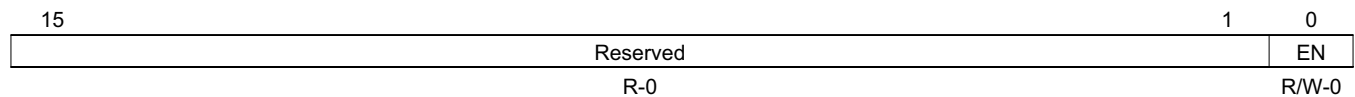
**Table 192. Edge Enhancer Enable Register (YEE\_EN) Field Descriptions**

Bit	Field	Value	Description
15-1	Reserved	0	Reserved.
0	EN		Edge enhancer enable.
		0	Disable.
		1	Enable.

### 6.3.71 MedianNR Enable Register (YEE\_EMF)

The MedianNR enable register (YEE\_EMF) is shown in [Figure 226](#) and described in [Table 193](#).

**Figure 226. MedianNR Enable Register (YEE\_EMF)**



LEGEND: R/W = Read/Write; R = Read only; -n = value after reset

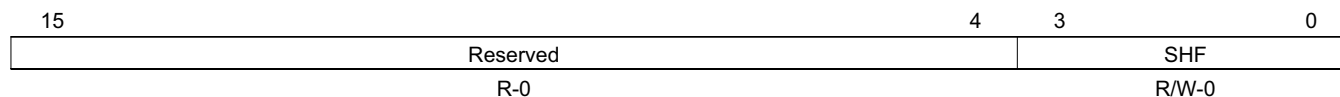
**Table 193. MedianNR Enable Register (YEE\_EMF) Field Descriptions**

Bit	Field	Value	Description
15-1	Reserved	0	Reserved.
0	EN		MedianNR enable.
		0	Disable.
		1	Enable.

### 6.3.72 HPF Shift Length Register (YEE\_SHF)

The HPF shift length register (YEE\_SHF) is shown in [Figure 227](#) and described in [Table 194](#).

**Figure 227. HPF Shift Length Register (YEE\_SHF)**



LEGEND: R/W = Read/Write; R = Read only; -n = value after reset

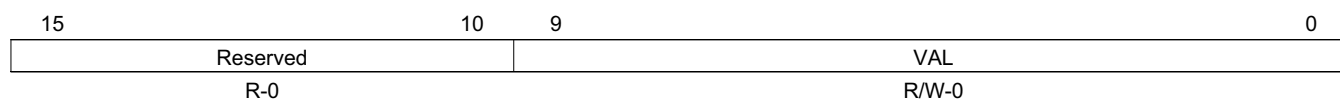
**Table 194. HPF Shift Length Register (YEE\_SHF) Field Descriptions**

Bit	Field	Value	Description
15-4	Reserved	0	Reserved.
3-0	SHF	0-Fh	HPF shift length. Down shift length of high pass filter (HPF) in edge enhancer.

### 6.3.73 HPF Coefficient 00 Register (YEE\_MUL\_00)

The HPF coefficient 00 register (YEE\_MUL\_00) is shown in [Figure 228](#) and described in [Table 195](#).

**Figure 228. HPF Coefficient 00 Register (YEE\_MUL\_00)**



LEGEND: R/W = Read/Write; R = Read only; -n = value after reset

**Table 195. HPF Coefficient 00 Register (YEE\_MUL\_00) Field Descriptions**

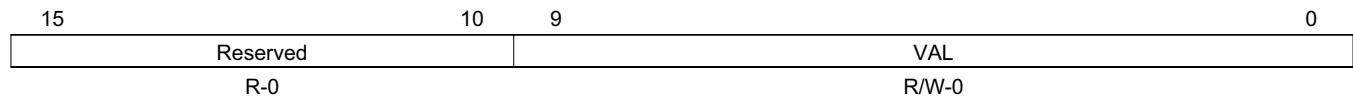
Bit	Field	Value	Description
15-10	Reserved	0	Reserved.
9-0	VAL	0-3FFh	HPF coefficient 00. Value is in S10Q0.



### 6.3.74 HPF Coefficient 01 Register (YEE\_MUL\_01)

The HPF coefficient 01 register (YEE\_MUL\_01) is shown in [Figure 229](#) and described in [Table 196](#).

**Figure 229. HPF Coefficient 01 Register (YEE\_MUL\_01)**



LEGEND: R/W = Read/Write; R = Read only; -n = value after reset

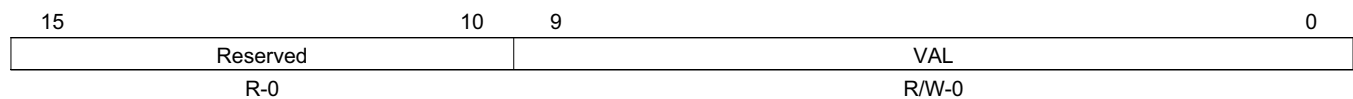
**Table 196. HPF Coefficient 01 Register (YEE\_MUL\_01) Field Descriptions**

Bit	Field	Value	Description
15-10	Reserved	0	Reserved.
9-0	VAL	0-3FFh	HPF coefficient 01. Value is in S10Q0.

### 6.3.75 HPF Coefficient 02 Register (YEE\_MUL\_02)

The HPF coefficient 02 register (YEE\_MUL\_02) is shown in [Figure 230](#) and described in [Table 197](#).

**Figure 230. HPF Coefficient 02 Register (YEE\_MUL\_02)**



LEGEND: R/W = Read/Write; R = Read only; -n = value after reset

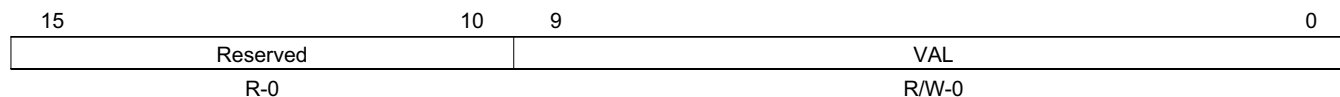
**Table 197. HPF Coefficient 02 Register (YEE\_MUL\_02) Field Descriptions**

Bit	Field	Value	Description
15-10	Reserved	0	Reserved.
9-0	VAL	0-3FFh	HPF coefficient 02. Value is in S10Q0.

### 6.3.76 HPF Coefficient 10 Register (YEE\_MUL\_10)

The HPF coefficient 10 register (YEE\_MUL\_10) is shown in [Figure 231](#) and described in [Table 198](#).

**Figure 231. HPF Coefficient 10 Register (YEE\_MUL\_10)**



LEGEND: R/W = Read/Write; R = Read only; -n = value after reset

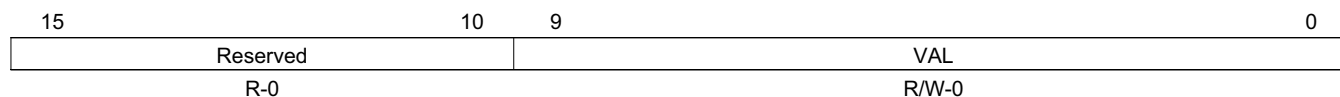
**Table 198. HPF Coefficient 10 Register (YEE\_MUL\_10) Field Descriptions**

Bit	Field	Value	Description
15-10	Reserved	0	Reserved.
9-0	VAL	0-3FFh	HPF coefficient 10. Value is in S10Q0.

### 6.3.77 HPF Coefficient 11 Register (YEE\_MUL\_11)

The HPF coefficient 11 register (YEE\_MUL\_11) is shown in [Figure 232](#) and described in [Table 199](#).

**Figure 232. HPF Coefficient 11 Register (YEE\_MUL\_11)**



LEGEND: R/W = Read/Write; R = Read only; -n = value after reset

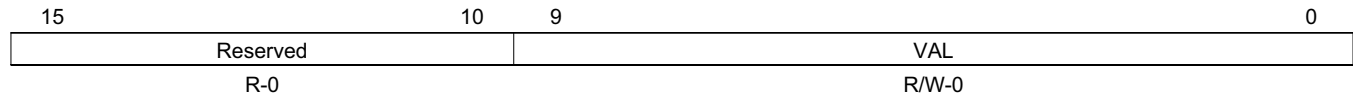
**Table 199. HPF Coefficient 11 Register (YEE\_MUL\_11) Field Descriptions**

Bit	Field	Value	Description
15-10	Reserved	0	Reserved.
9-0	VAL	0-3FFh	HPF coefficient 11. Value is in S10Q0.

### 6.3.78 HPF Coefficient 12 Register (YEE\_MUL\_12)

The HPF coefficient 12 register (YEE\_MUL\_12) is shown in [Figure 233](#) and described in [Table 200](#).

**Figure 233. HPF Coefficient 12 Register (YEE\_MUL\_12)**



LEGEND: R/W = Read/Write; R = Read only; -n = value after reset

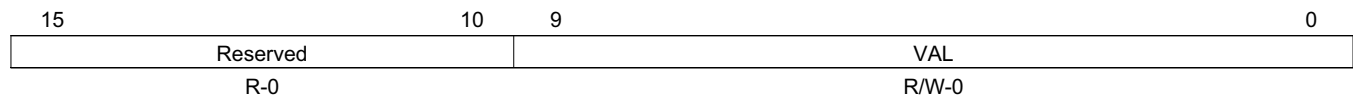
**Table 200. HPF Coefficient 12 Register (YEE\_MUL\_12) Field Descriptions**

Bit	Field	Value	Description
15-10	Reserved	0	Reserved.
9-0	VAL	0-3FFh	HPF coefficient 12. Value is in S10Q0.

### 6.3.79 HPF Coefficient 20 Register (YEE\_MUL\_20)

The HPF coefficient 20 register (YEE\_MUL\_20) is shown in [Figure 234](#) and described in [Table 201](#).

**Figure 234. HPF Coefficient 20 Register (YEE\_MUL\_20)**



LEGEND: R/W = Read/Write; R = Read only; -n = value after reset

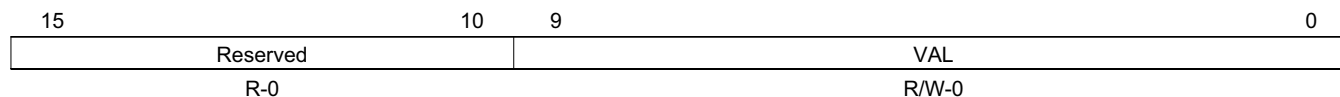
**Table 201. HPF Coefficient 20 Register (YEE\_MUL\_20) Field Descriptions**

Bit	Field	Value	Description
15-10	Reserved	0	Reserved
9-0	VAL	0-3FFh	HPF coefficient 20. Value is in S10Q0.

### 6.3.80 HPF Coefficient 21 Register (YEE\_MUL\_21)

The HPF coefficient 21 register (YEE\_MUL\_21) is shown in [Figure 235](#) and described in [Table 202](#).

**Figure 235. HPF Coefficient 21 Register (YEE\_MUL\_21)**



LEGEND: R/W = Read/Write; R = Read only; -n = value after reset

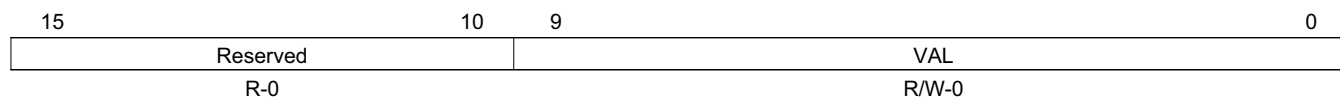
**Table 202. HPF Coefficient 21 Register (YEE\_MUL\_21) Field Descriptions**

Bit	Field	Value	Description
15-10	Reserved	0	Reserved
9-0	VAL	0-3FFh	HPF coefficient 21. Value is in S10Q0.

### 6.3.81 HPF Coefficient 22 Register (YEE\_MUL\_22)

The HPF coefficient 22 register (YEE\_MUL\_22) is shown in [Figure 236](#) and described in [Table 203](#).

**Figure 236. HPF Coefficient 22 Register (YEE\_MUL\_22)**



LEGEND: R/W = Read/Write; R = Read only; -n = value after reset

**Table 203. HPF Coefficient 22 Register (YEE\_MUL\_22) Field Descriptions**

Bit	Field	Value	Description
15-10	Reserved	0	Reserved
9-0	VAL	0-3FFh	HPF coefficient 22. Value is in S10Q0.

### 6.3.82 Fault Color Suppression Enable Register (FCS\_EN)

The fault color suppression enable register (FCS\_EN) is shown in [Figure 237](#) and described in [Table 204](#).

**Figure 237. Fault Color Suppression Enable Register (FCS\_EN)**

15	Reserved	1	0
R-0		EN R/W-0	

LEGEND: R/W = Read/Write; R = Read only; -n = value after reset

**Table 204. Fault Color Suppression Enable Register (FCS\_EN) Field Descriptions**

Bit	Field	Value	Description
15-1	Reserved	0	Reserved.
0	EN	0	Fault color suppression enable.
		0	Disable.
		1	Enable.

### 6.3.83 Type selection of HPF Register (FCS\_TYP)

The type selection of HPF Register (FCS\_TYP) is shown in [Figure 238](#) and described in [Table 205](#).

**Figure 238. Type selection of HPF Register (FCS\_TYP)**

15	Reserved	3	2	0
R-0			TYP R/W-0	

LEGEND: R/W = Read/Write; R = Read only; -n = value after reset

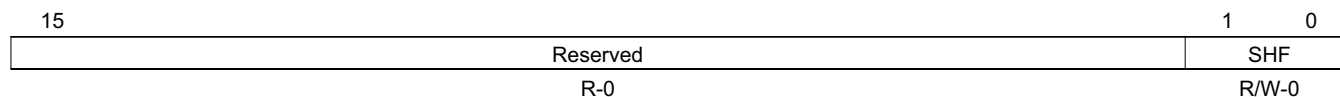
**Table 205. Type selection of HPF Register (FCS\_TYP) Field Descriptions**

Bit	Field	Value	Description
15-3	Reserved	0	Reserved.
2-0	TYP		Type of HPF.
		0	Y.
		1	horizontal HPF.
		2	vertical HPF.
		3	2D HPF.
	4	2D HPF from edge enhancement.	

### 6.3.84 Down Shift Size (HPF) Register (FCS\_SHF\_Y)

The down shift size (HPF) Register (FCS\_SHF\_Y) is shown in [Figure 239](#) and described in [Table 206](#).

**Figure 239. Down Shift Size (HPF) Register (FCS\_SHF\_Y)**



LEGEND: R/W = Read/Write; R = Read only; -n = value after reset

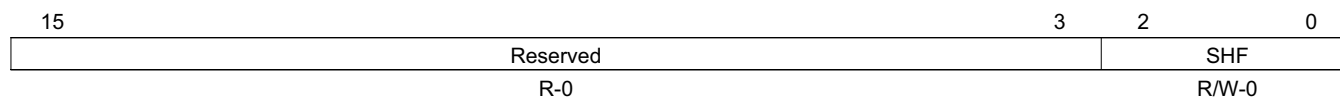
**Table 206. Down Shift Size (HPF) Register (FCS\_SHF\_Y) Field Descriptions**

Bit	Field	Value	Description
15-2	Reserved	0	Reserved.
1-0	SHF	0-3	Down shift value for HPF

### 6.3.85 Down Shift Size (GAIN) Register (FCS\_SHF\_C)

The Down Shift Size (GAIN) Register (FCS\_SHF\_C) is shown in [Figure 240](#) and described in [Table 207](#).

**Figure 240. Down Shift Size (GAIN) Register (FCS\_SHF\_C)**



LEGEND: R/W = Read/Write; R = Read only; -n = value after reset

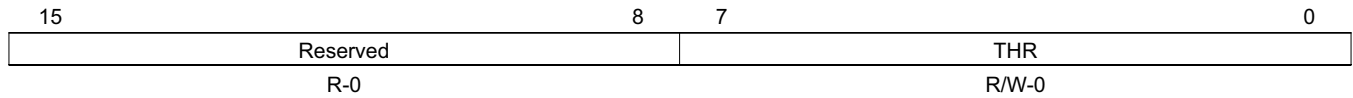
**Table 207. Down Shift Size (GAIN) Register (FCS\_SHF\_C) Field Descriptions**

Bit	Field	Value	Description
15-3	Reserved	0	Reserved.
2-0	SHF	0-7	Down shift value for GAIN function.

### 6.3.86 Threshold Register (FCS\_THR)

The threshold register (FCS\_THR) is shown in [Figure 241](#) and described in [Table 208](#).

**Figure 241. Threshold Register (FCS\_THR)**



LEGEND: R/W = Read/Write; R = Read only; -n = value after reset

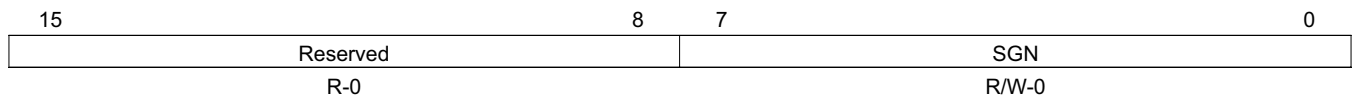
**Table 208. Threshold Register (FCS\_THR) Field Descriptions**

Bit	Field	Value	Description
15-9	Reserved	0	Reserved.
8-0	THR	0-1FFh	Threshold of the suppression gain.

### 6.3.87 Intensity Register (FCS\_SGN)

The Intensity Register (FCS\_SGN) is shown in [Figure 242](#) and described in [Table 209](#).

**Figure 242. Intensity Register (FCS\_SGN)**



LEGEND: R/W = Read/Write; R = Read only; -n = value after reset

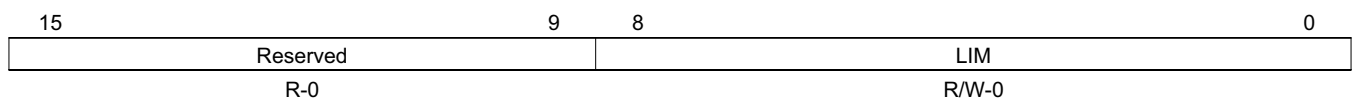
**Table 209. Intensity Register (FCS\_SGN) Field Descriptions**

Bit	Field	Value	Description
15-9	Reserved	0	Reserved.
8-0	SGN	0-1FFh	Intensity of the color suppression.

### 6.3.88 Lower Limit of Chroma Gain Register (FCS\_LTH)

The lower limit of chroma gain register (FCS\_LTH) is shown in [Figure 243](#) and described in [Table 210](#).

**Figure 243. Lower Limit of Chroma Gain Register (FCS\_LTH)**



LEGEND: R/W = Read/Write; R = Read only; -n = value after reset

**Table 210. Lower Limit of Chroma Gain Register (FCS\_LTH) Field Descriptions**

Bit	Field	Value	Description
15-9	Reserved	0	Reserved
8-0	LIM	0-1FFh	Lower limit of chroma gain. Range: 0= LIM =256.

### 6.3.89 Processing Mode Register (RSZ\_SEQ)

The processing mode register (RSZ\_SEQ) is shown in [Figure 244](#) and described in [Table 211](#).

**Figure 244. Processing Mode Register (RSZ\_SEQ)**

15	5	4	3	2	1	0			
Reserved					CRV	VRV	HRV	TMM	SEQ
R-0					R/W-0	R/W-0	R/W-0	R/W-0	R/W-0

LEGEND: R/W = Read/Write; R = Read only; -n = value after reset

**Table 211. Processing Mode Register (RSZ\_SEQ) Field Descriptions**

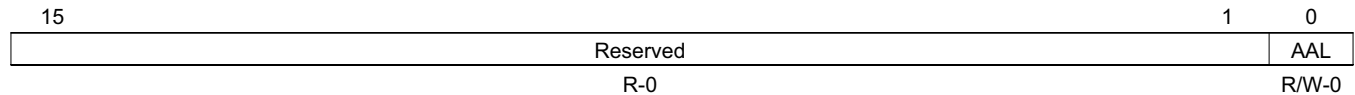
Bit	Field	Value	Description
15-5	Reserved	0	Reserved.
4	CRV	0	Chroma sampling point change. Chroma sampling point is not changed.
		1	Chroma sampling point is changed from odd-numbered pixels to even-number pixels. The pixel the left end is removed and the pixel at the right end is duplicated.
3	VRV	0	Vertical reversal of output image. Processed lines are output in the order of input (normal operation) in vertical direction.
		1	The order of output data is flipped top to bottom.
2	HRV	0	Horizontal reversal of output image. Processed pixels are output in the order of input (normal operation) in horizontal direction.
		1	The order of output data is flipped left to right.
1	TMM	0	Terminal condition of vertical processing. Output line number confined mode (normal mode). The module continues output of resized image until the number of output lines reaches the value set by RZA_O_VSZ and RZB_O_VSZ.
		1	Input line number confined mode. The modules continues output of resized image until the input number of input lines reads the value set by RZA_I_VSZ and RZB_I_VSZ. The numbers of output lines are output to RZA_V_SIZ_O and RZB_V_SIZ_O.
0	SEQ	0	Operation mode of vertical processing. Normal mode. The module clears register values and internal buffer values at VSYNC.
		1	Continuous mode. Resizer holds values from the previous operation. This mode may only be used in combination with input line number confined mode (TMM).



### 6.3.90 Vertical Anti aliasing Filter Register (RSZ\_AAL)

The vertical anti aliasing filter register (RSZ\_AAL) is shown in [Figure 245](#) and described in [Table 212](#).

**Figure 245. Vertical Anti aliasing Filter Register (RSZ\_AAL)**



LEGEND: R/W = Read/Write; R = Read only; -n = value after reset

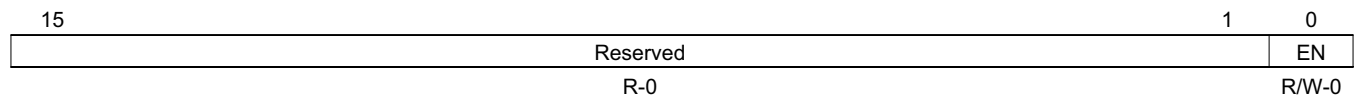
**Table 212. Vertical Anti aliasing Filter Register (RSZ\_AAL) Field Descriptions**

Bit	Field	Value	Description
15-1	Reserved	0	Reserved.
0	AAL	0	Vertical anti aliasing filter enable. Disable.
		1	Enable.

### 6.3.91 Resizer Enable Register (RSZ\_EN)

The resizer enable register (RSZ\_EN) is shown in [Figure 246](#) and described in [Table 213](#).

**Figure 246. Resizer Enable Register (RSZ\_EN)**



LEGEND: R/W = Read/Write; R = Read only; -n = value after reset

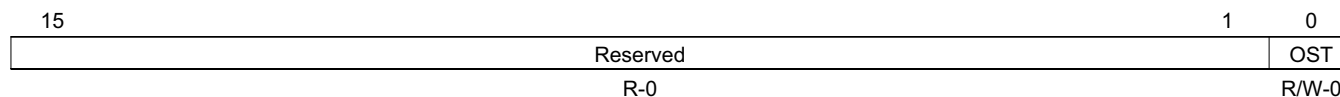
**Table 213. Resizer Enable Register (RSZ\_EN) Field Descriptions**

Bit	Field	Value	Description
15-1	Reserved	0	Reserved.
0	EN	0	Resizer enable. Disable.
		1	Enable.

### 6.3.92 One Shot Mode Register (RSZ\_MODE)

The one shot mode register (RSZ\_MODE) is shown in [Figure 247](#) and described in [Table 214](#).

**Figure 247. One Shot Mode Register (RSZ\_MODE)**



LEGEND: R/W = Read/Write; R = Read only; -n = value after reset

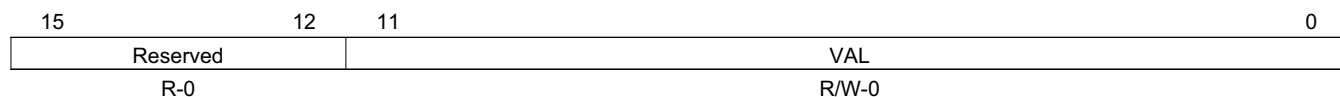
**Table 214. One Shot Mode Register (RSZ\_MODE) Field Descriptions**

Bit	Field	Value	Description
15-1	Reserved	0	Reserved.
0	OST		One shot mode enable.
		0	Continuous mode.
		1	One shot mode.

### 6.3.93 Vertical Start Position of the Input Register (RSZ\_I\_VST)

The Vertical Start Position of the Input Register (RSZ\_I\_VST) is shown in [Figure 248](#) and described in [Table 215](#).

**Figure 248. Vertical Start Position of the Input Register (RSZ\_I\_VST)**



LEGEND: R/W = Read/Write; R = Read only; -n = value after reset

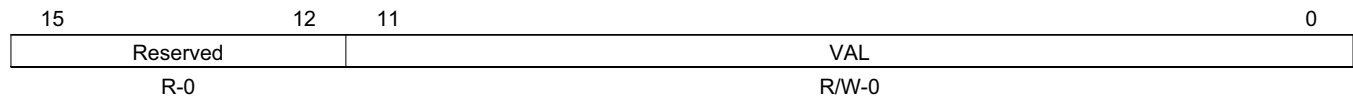
**Table 215. Vertical Start Position of the Input Register (RSZ\_I\_VST) Field Descriptions**

Bit	Field	Value	Description
15-12	Reserved	0	Reserved.
11-0	VAL	0-FFFh	Vertical start position of image processing. After IPIPE_VST, the VAL line is processed as the first line in each image.

### 6.3.94 Vertical Size of the Input Register (RSZ\_I\_VSZ)

The vertical size of the input register (RSZ\_I\_VSZ) is shown in [Figure 249](#) and described in [Table 216](#).

**Figure 249. Vertical Size of the Input Register (RSZ\_I\_VSZ)**



LEGEND: R/W = Read/Write; R = Read only; -n = value after reset

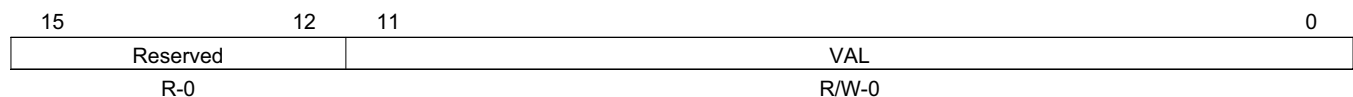
**Table 216. Vertical Size of the Input Register (RSZ\_I\_VSZ) Field Descriptions**

Bit	Field	Value	Description
15-12	Reserved	0	Reserved.
11-0	VAL	0-FFFh	Number of input lines. This value is used only in input line confined mode. (RSZ_SEQ[TMM] at 0108h). The number of input lines is (VAL + 1).

### 6.3.95 Horizontal Start Position of the Input Register (RSZ\_I\_HST)

The horizontal start position of the input register (RSZ\_I\_HST) is shown in [Figure 250](#) and described in [Table 217](#).

**Figure 250. Horizontal Start Position of the Input Register (RSZ\_I\_HST)**



LEGEND: R/W = Read/Write; R = Read only; -n = value after reset

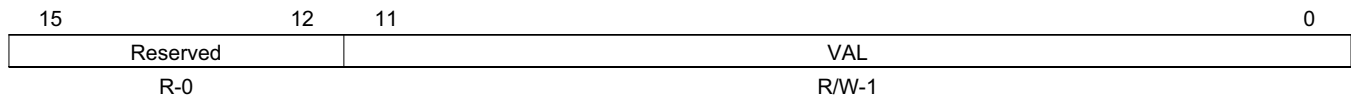
**Table 217. Horizontal Start Position of the Input Register (RSZ\_I\_HST) Field Descriptions**

Bit	Field	Value	Description
15-12	Reserved	0	Reserved.
11-0	VAL	0-FFFh	Horizontal start position of image processing. (RSZ_I_HST[0] is held low so this value must be even). After IPIPE_HST, the VAL pixel is processed as the first pixel.

### 6.3.96 Vertical Size of the Output Register (RSZ\_O\_VSZ)

The vertical size of the output register (RSZ\_O\_VSZ) is shown in [Figure 251](#) and described in [Table 218](#).

**Figure 251. Vertical Size of the Output Register (RSZ\_O\_VSZ)**



LEGEND: R/W = Read/Write; R = Read only; -n = value after reset

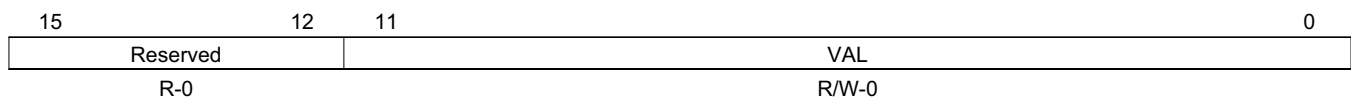
**Table 218. Vertical Size of the Output Register (RSZ\_O\_VSZ) Field Descriptions**

Bit	Field	Value	Description
15-12	Reserved	0	Reserved.
11-0	VAL	0-FFFh	Vertical size of the output image. The number of output lines is (VAL + 1). (RSZ_O_VSZ[0] is held high so this value must be odd).

### 6.3.97 Horizontal Start Position of the Output Register (RSZ\_O\_HST)

The horizontal start position of the output register (RSZ\_O\_HST) is shown in [Figure 252](#) and described in [Table 219](#).

**Figure 252. Horizontal Start Position of the Output Register (RSZ\_O\_HST)**



LEGEND: R/W = Read/Write; R = Read only; -n = value after reset

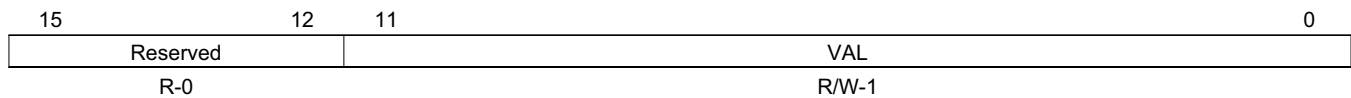
**Table 219. Horizontal Start Position of the Output Register (RSZ\_O\_HST) Field Descriptions**

Bit	Field	Value	Description
15-12	Reserved	0	Reserved.
11-0	VAL	0-FFFh	Horizontal position of the first pixel to be output in processed image. The first VAL pixels of the resized area in each line are discarded, and the next pixel becomes the first to be output. (RSZ_O_HST[0] is held low so this value must be even).

### 6.3.98 Horizontal Size of the Output Register (RSZ\_O\_HSZ)

The horizontal size of the output register (RSZ\_O\_HSZ) is shown in [Figure 253](#) and described in [Table 220](#).

**Figure 253. Horizontal Size of the Output Register (RSZ\_O\_HSZ)**



LEGEND: R/W = Read/Write; R = Read only; -n = value after reset

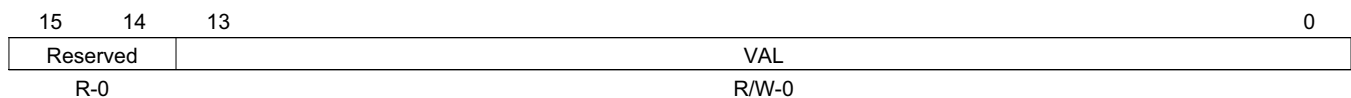
**Table 220. Horizontal Size of the Output Register (RSZ\_O\_HSZ) Field Descriptions**

Bit	Field	Value	Description
15-12	Reserved	0	Reserved.
11-0	VAL	0-FFFh	Horizontal size of output image. The number of pixel in each line is (VAL + 1). RSZ[0]:Value must be lower than 1344 except in RAW passthu mode. RSZ[1]:Value must be lower than 640. (RSZ_O_HSZ[0] is held high so this value must be odd).

### 6.3.99 Initial Phase of Vertical Resizing Process Register (RSZ\_V\_PHS)

The initial phase of vertical resizing process register (RSZ\_V\_PHS) is shown in [Figure 254](#) and described in [Table 221](#).

**Figure 254. Initial Phase of Vertical Resizing Process Register (RSZ\_V\_PHS)**



LEGEND: R/W = Read/Write; R = Read only; -n = value after reset

**Table 221. Initial Phase of Vertical Resizing Process Register (RSZ\_V\_PHS) Field Descriptions**

Bit	Field	Value	Description
15-14	Reserved	0	Reserved.
13-0	VAL	0-3FFFh	Initial value for the phase value in vertical resizing process. (Should be set to zero except in Frame Division Mode-H). Valid range: 0-8191.

### 6.3.100 Phase of Last Value in Previous Resize Process Register (RSZ\_V\_PHS\_O)

The phase of last value in previous resize process register (RSZ\_V\_PHS\_O) is shown in [Figure 255](#) and described in [Table 222](#).

**Figure 255. Phase of Last Value in Previous Resize Process Register (RSZ\_V\_PHS\_O)**

15	14	13	0
Reserved		VAL	
R-0		R-0	

LEGEND: R/W = Read/Write; R = Read only; -n = value after reset

**Table 222. Phase of Last Value in Previous Resize Process Register (RSZ\_V\_PHS\_O) Field Descriptions**

Bit	Field	Value	Description
15-14	Reserved	0	Reserved.
13-0	VAL	0-3FFFh	Phase value of the last line in the previous resizing process. This value is only valid in input line number confined mode ((RSZ_SEQ[TMM] at 0x0108).

### 6.3.101 Vertical Resize Parameter Register (RSZ\_V\_DIF)

The vertical resize parameter register (RSZ\_V\_DIF) is shown in [Figure 256](#) and described in [Table 223](#).

**Figure 256. Vertical Resize Parameter Register (RSZ\_V\_DIF)**

15	14	13	0
Reserved		VAL	
R-0		R/W-0	

LEGEND: R/W = Read/Write; R = Read only; -n = value after reset

**Table 223. Vertical Resize Parameter Register (RSZ\_V\_DIF) Field Descriptions**

Bit	Field	Value	Description
15-14	Reserved	0	Reserved.
13-0	VAL	0-3FFFh	Vertical resize parameter. The actual resizing ratio is 256/VAL.

### 6.3.102 Actual Number of Output Lines Register (RSZ\_V\_SIZ\_O)

The actual number of output lines register (RSZ\_V\_SIZ\_O) is shown in [Figure 257](#) and described in [Table 224](#).

**Figure 257. Actual Number of Output Lines Register (RSZ\_V\_SIZ\_O)**

15	13	12	0
Reserved		VAL	
R-0		R-0	

LEGEND: R = Read only; -n = value after reset

**Table 224. Actual Number of Output Lines Register (RSZ\_V\_SIZ\_O) Field Descriptions**

Bit	Field	Value	Description
15-13	Reserved	0	Reserved.
12-0	VAL	0-1FFFh	Number of actually produced lines in the previous resizing process.

### 6.3.103 Initial Phase of Horizontal Resizing Process Register (RSZ\_H\_PHS)

The initial phase of horizontal resizing process register (RSZ\_H\_PHS) is shown in [Figure 258](#) and described in [Table 225](#).

**Figure 258. Initial Phase of Horizontal Resizing Process Register (RSZ\_H\_PHS)**

15	14	13	0
Reserved		VAL	
R-0		R/W-0	

LEGEND: R/W = Read/Write; R = Read only; -n = value after reset

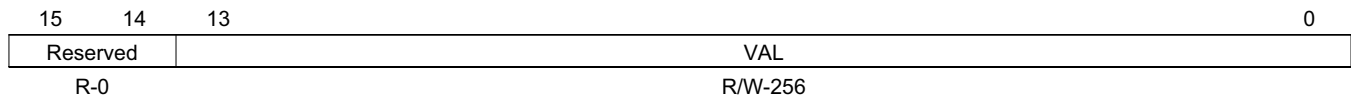
**Table 225. Initial Phase of Horizontal Resizing Process Register (RSZ\_H\_PHS) Field Descriptions**

Bit	Field	Value	Description
15-14	Reserved	0	Reserved.
13-0	VAL	0-3FFFh	Initial value for the phase value in horizontal resizing process. (Should be set to zero except in Frame Division Mode-V). Valid range: 0-8192.

### 6.3.104 Horizontal Resize Parameter Register (RSZ\_H\_DIF)

The horizontal resize parameter register (RSZ\_H\_DIF) is shown in [Figure 259](#) and described in [Table 226](#).

**Figure 259. Horizontal Resize Parameter Register (RSZ\_H\_DIF)**



LEGEND: R/W = Read/Write; R = Read only; -n = value after reset

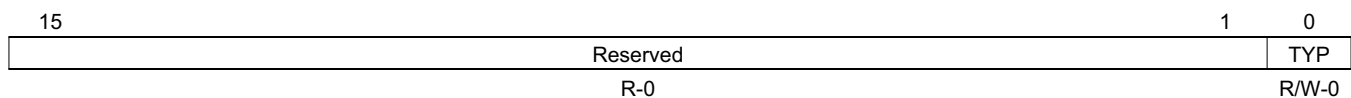
**Table 226. Horizontal Resize Parameter Register (RSZ\_H\_DIF) Field Descriptions**

Bit	Field	Value	Description
15-14	Reserved	0	Reserved.
13-0	VAL	0-3FFFh	Horizontal resize parameter. The actual resizing ratio is 256/VAL.

### 6.3.105 Interpolation Method for Horizontal Rescaling Register (RSZ\_H\_TYP)

The interpolation method for horizontal rescaling register (RSZ\_H\_TYP) is shown in [Figure 260](#) and described in [Table 227](#).

**Figure 260. Interpolation Method for Horizontal Rescaling Register (RSZ\_H\_TYP)**



LEGEND: R/W = Read/Write; R = Read only; -n = value after reset

**Table 227. Interpolation Method for Horizontal Rescaling Register (RSZ\_H\_TYP) Field Descriptions**

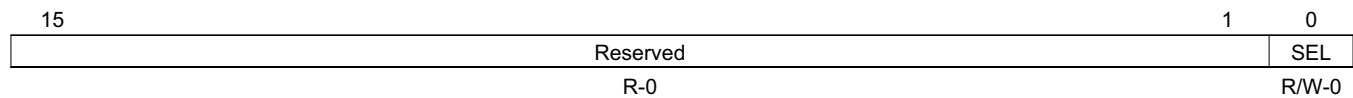
Bit	Field	Value	Description
15-1	Reserved	0	Reserved.
0	TYP		Selection of resizing method in horizontal direction.
		0	4-tap cubic convolution.
		1	2-tap linear interpolation.



### 6.3.106 Selection of Horizontal LPF Intensity Register (RSZ\_H\_LSE)

The selection of horizontal LPF intensity register (RSZ\_H\_LSE) is shown in [Figure 261](#) and described in [Table 228](#).

**Figure 261. Selection of Horizontal LPF Intensity Register (RSZ\_H\_LSE)**



LEGEND: R/W = Read/Write; R = Read only; -n = value after reset

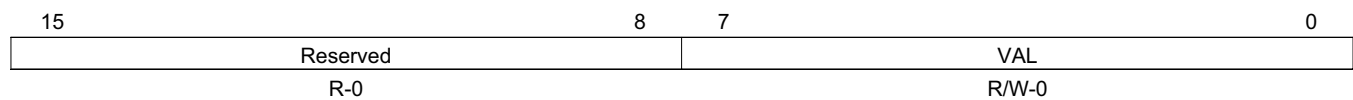
**Table 228. Selection of Horizontal LPF Intensity Register (RSZ\_H\_LSE) Field Descriptions**

Bit	Field	Value	Description
15-1	Reserved	0	Reserved.
0	SEL	0	Selection of the intensity value for horizontal low pass filtering. Use an internally calculated value.
		1	Use the value set by the register (RSZ_H_LPF).

### 6.3.107 Horizontal LPF Intensity Register (RSZ\_H\_LPF)

The horizontal LPF intensity register (RSZ\_H\_LPF) is shown in [Figure 262](#) and described in [Table 229](#).

**Figure 262. Horizontal LPF Intensity Register (RSZ\_H\_LPF)**



LEGEND: R/W = Read/Write; R = Read only; -n = value after reset

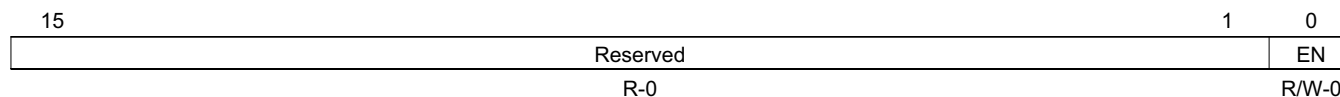
**Table 229. Horizontal LPF Intensity Register (RSZ\_H\_LPF) Field Descriptions**

Bit	Field	Value	Description
15-8	Reserved	0	Reserved.
7-0	VAL	0-FFh	Intensity parameter for horizontal low pass filtering. Used when RZA_H_LSE is high.

### 6.3.108 RGB Output Enable Register (RSZ\_RGB\_EN)

The RGB output enable register (RSZ\_RGB\_EN) is shown in [Figure 263](#) and described in [Table 230](#).

**Figure 263. RGB Output Enable Register (RSZ\_RGB\_EN)**



LEGEND: R/W = Read/Write; R = Read only; -n = value after reset

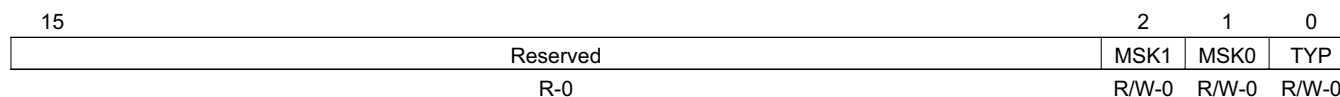
**Table 230. RGB Output Enable Register (RSZ\_RGB\_EN) Field Descriptions**

Bit	Field	Value	Description
15-1	Reserved	0	Reserved.
0	EN	0	RGB output enable. Disable.
		1	Enable.

### 6.3.109 RGB Output Bit Mode (32 or 16 bit) Register (RSZ\_RGB\_TYP)

The RGB output bit mode (32 or 16 bit) register (RSZ\_RGB\_TYP) is shown in [Figure 264](#) and described in [Table 231](#).

**Figure 264. RGB Output Bit Mode (32 or 16 bit) Register (RSZ\_RGB\_TYP)**



LEGEND: R/W = Read/Write; R = Read only; -n = value after reset

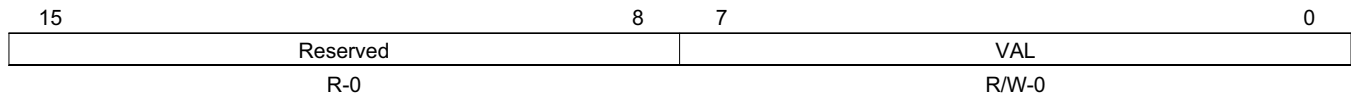
**Table 231. RGB Output Bit Mode (32 or 16 bit) Register (RSZ\_RGB\_TYP) Field Descriptions**

Bit	Field	Value	Description
15-3	Reserved	0	Reserved.
2	MSK1	0	Enable masking of the last 2 pixels. (NOMASK) output the last 2 pixels.
		1	(MASKLAST2) mask the last 2 pixels (do not output).
1	MSK0	0	Enable masking of the first 2 pixels. (NOMASK) output the first 2 pixels.
		1	(MASKFIRST2) mask the first 2 pixels (do not output).
0	TYP	0	16bit/32bit output selection. (OUTPUT32BITS) 32 bit output; alpha + R + G + B (8 bit each).
		1	(OUTPUT16BITS) 16 bit output; R(5bit) + G(6bit) + B(5bit).

### 6.3.110 YC422 to YC444 Conversion Method Register (RSZ\_RGB\_BLD)

The YC422 to YC444 conversion method register (RSZ\_RGB\_BLD) is shown in [Figure 265](#) and described in [Table 232](#).

**Figure 265. YC422 to YC444 Conversion Method Register (RSZ\_RGB\_BLD)**



LEGEND: R/W = Read/Write; R = Read only; -n = value after reset

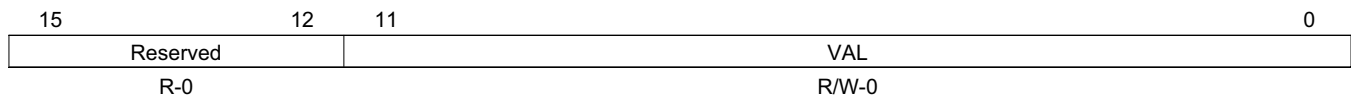
**Table 232. YC422 to YC444 Conversion Method Register (RSZ\_RGB\_BLD) Field Descriptions**

Bit	Field	Value	Description
15-8	Reserved	0	Reserved.
7-0	VAL	0-FFh	The alpha value used in 32_bit output mode.

### 6.3.111 SDRAM Base Address MSB Register (RSZ\_SDR\_BAD\_H)

The SDRAM base address MSB register (RSZ\_SDR\_BAD\_H) is shown in [Figure 266](#) and described in [Table 233](#).

**Figure 266. SDRAM Base Address MSB Register (RSZ\_SDR\_BAD\_H)**



LEGEND: R/W = Read/Write; R = Read only; -n = value after reset

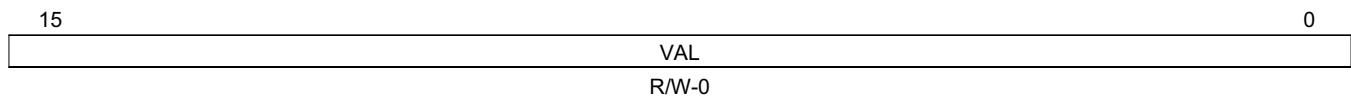
**Table 233. SDRAM Base Address MSB Register (RSZ\_SDR\_BAD\_H) Field Descriptions**

Bit	Field	Value	Description
15-12	Reserved	0	Reserved.
11-0	VAL	0-FFFh	The upper 11 bits of the first address in the allowed memory space in buffer memory or SDRAM.

### 6.3.112 SDRAM Base Address LSB Register (RSZ\_SDR\_BAD\_L)

The SDRAM base address LSB register (RSZ\_SDR\_BAD\_L) is shown in [Figure 267](#) and described in [Table 234](#).

**Figure 267. SDRAM Base Address LSB Register (RSZ\_SDR\_BAD\_L)**



LEGEND: R/W = Read/Write; -n = value after reset

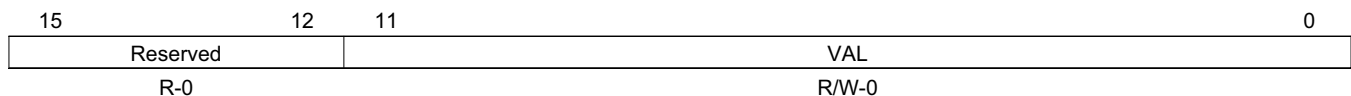
**Table 234. SDRAM Base Address LSB Register (RSZ\_SDR\_BAD\_L) Field Descriptions**

Bit	Field	Value	Description
15-0	VAL	0-FFFFh	The lower 16 bits of the first address in the allowed memory space in buffer memory or SDRAM. In Resize mode, the lowest 2 bits should be 00 when horizontal reversal mode ((RSZ_SEQ[HRV] at 0x0108) is off. These 2 bits should be 11 when horizontal reversal mode is on. In RGB output mode, the lowest 5 bits must be 00000.

### 6.3.113 SDRAM Start Address MSB Register (RSZ\_SDR\_SAD\_H)

The SDRAM start address MSB register (RSZ\_SDR\_SAD\_H) is shown in [Figure 268](#) and described in [Table 235](#).

**Figure 268. SDRAM Start Address MSB Register (RSZ\_SDR\_SAD\_H)**



LEGEND: R/W = Read/Write; R = Read only; -n = value after reset

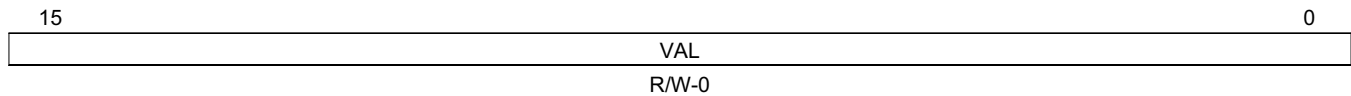
**Table 235. SDRAM Start Address MSB Register (RSZ\_SDR\_SAD\_H) Field Descriptions**

Bit	Field	Value	Description
15-12	Reserved	0	Reserved.
11-0	VAL	0-FFFh	The higher 11 bits of the first address of output in buffer memory or SDRAM.

### 6.3.114 SDRAM Start Address LSB Register (RSZ\_SDR\_SAD\_L)

The SDRAM start address LSB register (RSZ\_SDR\_SAD\_L) is shown in [Figure 269](#) and described in [Table 236](#).

**Figure 269. SDRAM Start Address LSB Register (RSZ\_SDR\_SAD\_L)**



LEGEND: R/W = Read/Write; -n = value after reset

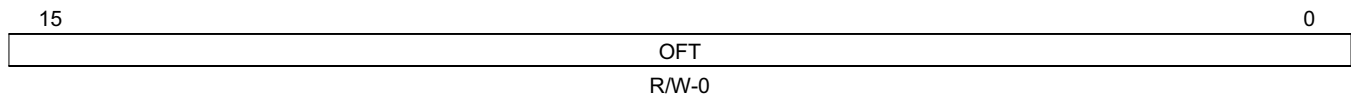
**Table 236. SDRAM Start Address LSB Register (RSZ\_SDR\_SAD\_L) Field Descriptions**

Bit	Field	Value	Description
15-0	VAL	0-FFFFh	The lower 16 bits of the first address of output in buffer memory or SDRAM. In Resize mode, The lowest 2 bits should be 00 when horizontal reversal mode (RSZ_SEQ[HRV] at 0x0108) is off. These 2 bits should be 11 when horizontal reversal mode is on. In RGB output mode, the lowest 5 bits must be 00000.

### 6.3.115 SDRAM Line Offset Register (RSZ\_SDR\_OFT)

The SDRAM line offset register (RSZ\_SDR\_OFT) is shown in [Figure 270](#) and described in [Table 237](#).

**Figure 270. SDRAM Line Offset Register (RSZ\_SDR\_OFT)**



LEGEND: R/W = Read/Write; -n = value after reset

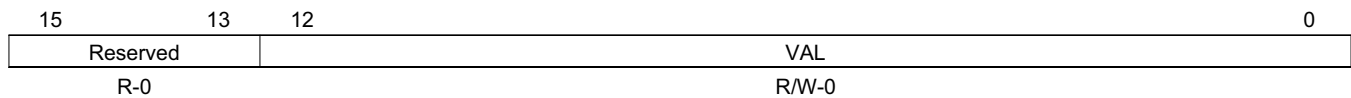
**Table 237. SDRAM Line Offset Register (RSZ\_SDR\_OFT) Field Descriptions**

Bit	Field	Value	Description
15-0	OFT	0-FFFFh	The size of the memory space for each line (in bytes). The first address of each output line should be SAD+(line+OFT). Examples are shown below. line 0: address = SAD + (0 × OFT) line 1: address = SAD + (1 × OFT) line 2: address = SAD + (2 × OFT) line 3: address = SAD + (3 × OFT)  This register value is neglected in RGB output mode. The lower 5 bits are held low, so this value should be a multiple of 32 bytes.

### 6.3.116 Start Line of SDRAM Pointer Register (RSZ\_SDR\_PTR\_S)

The start line of SDRAM pointer register (RSZ\_SDR\_PTR\_S) is shown in [Figure 271](#) and described in [Table 238](#).

**Figure 271. Start Line of SDRAM Pointer Register (RSZ\_SDR\_PTR\_S)**



LEGEND: R/W = Read/Write; R = Read only; -n = value after reset

**Table 238. Start Line of SDRAM Pointer Register (RSZ\_SDR\_PTR\_S) Field Descriptions**

Bit	Field	Value	Description
15-13	Reserved	0	Reserved.
12-0	VAL	0-1FFFh	The vertical position of the first output line in the output memory space. This value should be 0, when RZA_SAD=RZA_BAD. In RGB output mode, this value should be multiple of 4 (the lowest two bits be 00).

### 6.3.117 End Line of SDRAM Pointer Register (RSZ\_SDR\_PTR\_E)

The end line of SDRAM pointer register (RSZ\_SDR\_PTR\_E) is shown in [Figure 272](#) and described in [Table 239](#).

**Figure 272. End Line of SDRAM Pointer Register (RSZ\_SDR\_PTR\_E)**

15	13	12	0
Reserved		VAL	
R-0		R/W-8191	

LEGEND: R/W = Read/Write; R = Read only; -n = value after reset

**Table 239. End Line of SDRAM Pointer Register (RSZ\_SDR\_PTR\_E) Field Descriptions**

Bit	Field	Value	Description
15-13	Reserved	0	Reserved.
12-0	VAL	0-1FFFh	<p>SDRAM Available Capacity: The maximum number of lines to be stored in the memory space in Buffer Memory or DRAM.</p> <p>When the number output lines exceeds this value, the address restarts from the first address in the memory space.</p> <p>Example: VAL = 0x0003h</p> <p>line 0: address = SAD + (0 × OFT)</p> <p>line 1: address = SAD + (1 × OFT)</p> <p>line 2: address = SAD + (2 × OFT)</p> <p>line 3: address = SAD + (3 × OFT)</p> <p>line 4: address = SAD + (0 × OFT) &lt;= (Returned to the first address)</p> <p>line 5: address = SAD + (1 × OFT)</p> <p>line 6: address = SAD + (2 × OFT)</p> <p>line 7: address = SAD + (3 × OFT)</p> <p>line 8: address = SAD + (0 × OFT) &lt;= (Returned to the first address)</p> <p>line 9: address = SAD + (1 × OFT)</p> <p>line 10: address = SAD + (2 × OFT)</p> <p>line 11: address = SAD + (3 × OFT)</p> <p>In RGB output mode, this value should be multiple of 4 (the lowest two bits be 00) to ensure that the end of SDRAM region is aligned with line size.</p>

### 6.3.118 Output of Current Pointer Value (Read Only) Register (RSZ\_SDR\_PTR\_O)

The output of current pointer value (read only) register (RSZ\_SDR\_PTR\_O) is shown in [Figure 273](#) and described in [Table 240](#).

**Figure 273. Output of Current Pointer Value (Read Only) Register (RSZ\_SDR\_PTR\_O)**

15	13	12	0
Reserved		VAL	
R-0		R-0	

LEGEND: R = Read only; -n = value after reset

**Table 240. Output of Current Pointer Value (Read Only) Register (RSZ\_SDR\_PTR\_O) Field Descriptions**

Bit	Field	Value	Description
15-13	Reserved	0	Reserved.
12-0	VAL	0-1FFFh	Vertical position of the last line of the previous resizing process in the memory space. This value is not valid in RGB output mode.

### 6.3.119 Boxcar Enable Register (BOX\_EN)

The boxcar enable register (BOX\_EN) is shown in [Figure 274](#) and described in [Table 241](#).

**Figure 274. Boxcar Enable Register (BOX\_EN)**

15	1	0
Reserved		EN
R-0		R/W-0

LEGEND: R/W = Read/Write; R = Read only; -n = value after reset

**Table 241. Boxcar Enable Register (BOX\_EN) Field Descriptions**

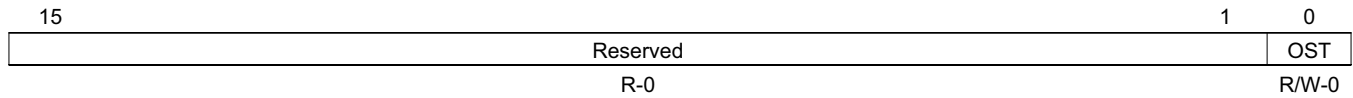
Bit	Field	Value	Description
15-1	Reserved	0	Reserved.
0	EN		Boxcar enable.
		0	Disable.
		1	Enable.



### 6.3.120 One Shot Mode Register (BOX\_MODE)

The one shot mode register (BOX\_MODE) is shown in [Figure 275](#) and described in [Table 242](#).

**Figure 275. One Shot Mode Register (BOX\_MODE)**



LEGEND: R/W = Read/Write; R = Read only; -n = value after reset

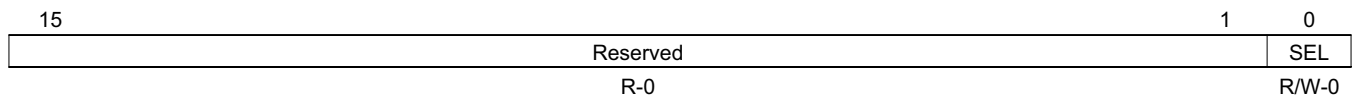
**Table 242. One Shot Mode Register (BOX\_MODE) Field Descriptions**

Bit	Field	Value	Description
15-1	Reserved	0	Reserved.
0	OST		One shot mode enable.
		0	Continuous mode.
		1	One shot mode.

### 6.3.121 Block Size (16 x 16 or 8 x 8) Register (BOX\_TYP)

The block size (16 × 16 or 8 × 8) register (BOX\_TYP) is shown in [Figure 276](#) and described in [Table 243](#).

**Figure 276. Block Size (16x16 or 8x8) Register (BOX\_TYP)**



LEGEND: R/W = Read/Write; R = Read only; -n = value after reset

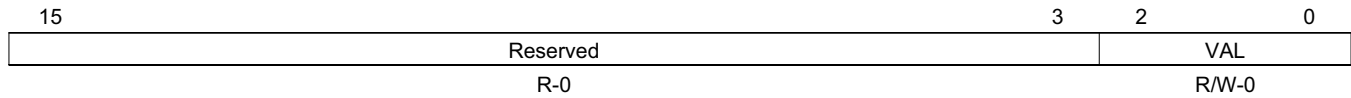
**Table 243. Block Size (16x16 or 8x8) Register (BOX\_TYP) Field Descriptions**

Bit	Field	Value	Description
15-1	Reserved	0	Reserved.
0	SEL		Block size in boxcar sampling.
		0	8 × 8
		1	16 × 16

### 6.3.122 Down Shift Value of Input Register (BOX\_SHF)

The down shift value of input register (BOX\_SHF) is shown in [Figure 277](#) and described in [Table 244](#).

**Figure 277. Down Shift Value of Input Register (BOX\_SHF)**



LEGEND: R/W = Read/Write; R = Read only; -n = value after reset

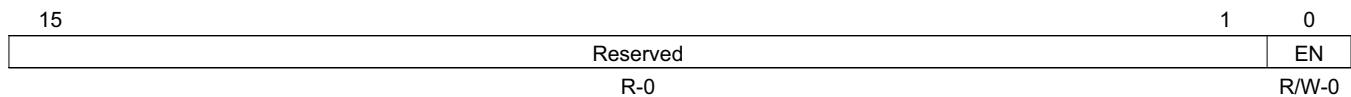
**Table 244. Down Shift Value of Input Register (BOX\_SHF) Field Descriptions**

Bit	Field	Value	Description
15-3	Reserved	0	Reserved.
2-0	VAL	0-7	Down shift value of input data (range: 0-4).

### 6.3.123 Histogram Enable Register (HST\_EN)

The histogram enable register (HST\_EN) is shown in [Figure 278](#) and described in [Table 245](#).

**Figure 278. Histogram Enable Register (HST\_EN)**



LEGEND: R/W = Read/Write; R = Read only; -n = value after reset

**Table 245. Histogram Enable Register (HST\_EN) Field Descriptions**

Bit	Field	Value	Description
15-1	Reserved	0	Reserved.
0	EN	0	Disable.
		1	Enable.

### 6.3.124 One Shot Mode Register (HST\_MODE)

The one shot mode register (HST\_MODE) is shown in [Figure 279](#) and described in [Table 246](#).

**Figure 279. One Shot Mode Register (HST\_MODE)**

15	Reserved	1	0
R-0			OST R/W-0

LEGEND: R/W = Read/Write; R = Read only; -n = value after reset

**Table 246. One Shot Mode Register (HST\_MODE) Field Descriptions**

Bit	Field	Value	Description
15-1	Reserved	0	Reserved.
0	OST		One shot mode enable.
		0	Continuous mode.
		1	One shot mode.

### 6.3.125 Histogram Source Select Register (HST\_SEL)

The histogram source select register (HST\_SEL) is shown in [Figure 280](#) and described in [Table 247](#).

**Figure 280. Histogram Source Select Register (HST\_SEL)**

15	Reserved	2	1	0
R-0			GREENSEL R/W-0	SOURCE R/W-0

LEGEND: R/W = Read/Write; R = Read only; -n = value after reset

**Table 247. Histogram Source Select Register (HST\_SEL) Field Descriptions**

Bit	Field	Value	Description
15-2	Reserved	0	Reserved.
1	GREENSEL		Green sampling selection.
		0	Gr is collected.
		1	Gb is collected.
0	SOURCE		Input selection.
		0	From horizontal defect correction (R/Gr/Gb/B).
		1	From RGB2YUV (RGB input + Y output).

### 6.3.126 Histogram Parameters Select Register (HST\_PARA)

The histogram parameters select register (HST\_PARA) is shown in [Figure 281](#) and described in [Table 248](#).

**Figure 281. Histogram Parameters Select Register (HST\_PARA)**

15	14	13	12	11		8	7	6	5	4	3	2	1	0
Reserved	BIN		SHF			COL3	COL2	COL1	COL0	RGN3	RGN2	RGN1	RGN0	
R-0	R/W-0		R/W-0			R/W-0	R/W-0	R/W-0	R/W-0	R/W-0	R/W-0	R/W-0	R/W-0	

LEGEND: R/W = Read/Write; R = Read only; -n = value after reset

**Table 248. Histogram Parameters Select Register (HST\_PARA) Field Descriptions**

Bit	Field	Value	Description
15-14	Reserved	0	Reserved.
13-12	BIN	0	32 bins.
		1	64 bins.
		2	128 bins.
		3	256 bins.
11-8	SHF	0-Fh	Shift length of input data.
7	COL3	0	Disable.
		1	Enable.
6	COL2	0	Disable.
		1	Enable.
5	COL1	0	Disable.
		1	Enable.
4	COL0	0	Disable.
		1	Enable.
3	RGN3	0	Disable.
		1	Enable.
2	RGN2	0	Disable.
		1	Enable.
1	RGN1	0	Disable.
		1	Enable.
0	RGN0	0	Disable.
		1	Enable.

### 6.3.127 Vertical Start Position Register (HST\_VST)

The vertical start position register (HST\_VST) is shown in [Figure 282](#) and described in [Table 249](#).

**Figure 282. Vertical Start Position Register (HST\_VST)**

15	12	11	0
Reserved		VAL	
R-0		R/W-0	

LEGEND: R/W = Read/Write; R = Read only; -n = value after reset

**Table 249. Vertical Start Position Register (HST\_VST) Field Descriptions**

Bit	Field	Value	Description
15-12	Reserved	0	Reserved.
11-0	VAL	0-FFFh	Vertical start position of the region from the IPIPE_VST. The region will start the Histogram processing from VAL line. (HST_VST[0] is held low so this value must be even).

### 6.3.128 Vertical Size Register (HST\_VSZ)

The vertical size register (HST\_VSZ) is shown in [Figure 283](#) and described in [Table 250](#).

**Figure 283. Vertical Size Register (HST\_VSZ)**

15	12	11	0
Reserved		VAL	
R-0		R/W-1	

LEGEND: R/W = Read/Write; R = Read only; -n = value after reset

**Table 250. Vertical Size Register (HST\_VSZ) Field Descriptions**

Bit	Field	Value	Description
15-12	Reserved	0	Reserved.
11-0	VAL	0-FFFh	Vertical size of the region. This value must be greater than 0. (0 is not allowed). The Histogram processing of the region will process (VAL + 1) lines. (HST_VSZ[0] is held high so this value must be odd).

### 6.3.129 Horizontal Start Position Register (HST\_HST)

The horizontal start position register (HST\_HST) is shown in [Figure 284](#) and described in [Table 251](#).

**Figure 284. Horizontal Start Position Register (HST\_HST)**

15	12	11	0
Reserved		VAL	
R-0		R/W-0	

LEGEND: R/W = Read/Write; R = Read only; -n = value after reset

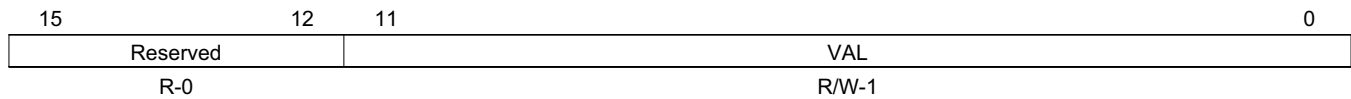
**Table 251. Horizontal Start Position Register (HST\_HST) Field Descriptions**

Bit	Field	Value	Description
15-12	Reserved	0	Reserved.
11-0	VAL	0-FFFh	Horizontal start position of the region from the IPIPE_HST. The region will start the "Histogram" processing from VAL pixel. (HST_HST[0] is held low so this value must be even).

### 6.3.130 Horizontal Size Register (HST\_HSZ)

The horizontal size register (HST\_HSZ) is shown in [Figure 285](#) and described in [Table 252](#).

**Figure 285. Horizontal Size Register (HST\_HSZ)**



LEGEND: R/W = Read/Write; R = Read only; -n = value after reset

**Table 252. Horizontal Size Register (HST\_HSZ) Field Descriptions**

Bit	Field	Value	Description
15-12	Reserved	0	Reserved. Read as zero.
11-0	VAL	0-FFFh	Horizontal size of the region This value must be greater than 0. (0 is not allowed). The "Histogram" processing of the region will process (VAL + 1) pixels. HST_HSZ[0] is held high so this value must be odd.

## 6.4 Hardware 3A Registers (H3A)

The Hardware 3A Registers (H3A) are shown in [Table 253](#).

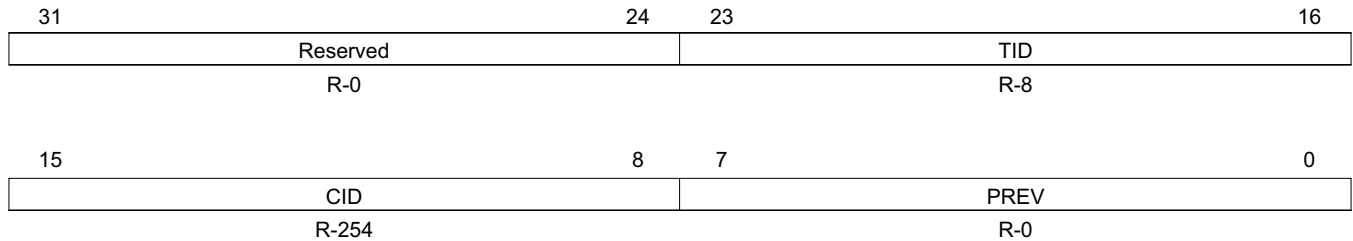
**Table 253. Hardware 3A Register Map (H3A)**

Address	Acronym	Register Description	Section
0x01C7:0080	PID	Peripheral Revision and Class Information	<a href="#">Section 6.4.1</a>
0x01C7:0084	PCR	Peripheral Control Register	<a href="#">Section 6.4.2</a>
0x01C7:0088	AFPAX1	Setup for the AF Engine Poxel Configuration	<a href="#">Section 6.4.3</a>
0x01C7:008C	AFPAX2	Setup for the AF Engine Poxel Configuration	<a href="#">Section 6.4.4</a>
0x01C7:0090	AFPAXSTART	Start Position for AF Engine Poxels	<a href="#">Section 6.4.5</a>
0x01C7:0094	AFIIRSH	Start Position for IIRSH	<a href="#">Section 6.4.6</a>
0x01C7:0098	AFBUFST	SDRAM/DDRAM Start Address for AF Engine	<a href="#">Section 6.4.7</a>
0x01C7:009C	AFCOEF010	IIR Filter Coefficient Data for SET 0	<a href="#">Section 6.4.8</a>
0x01C7:00A0	AFCOEF032	IIR Filter Coefficient Data for SET 0	<a href="#">Section 6.4.9</a>
0x01C7:00A4	AFCOEFF054	IIR Filter Coefficient Data for SET 0	<a href="#">Section 6.4.10</a>
0x01C7:00A8	AFCOEFF076	IIR Filter Coefficient Data for SET 0	<a href="#">Section 6.4.11</a>
0x01C7:00AC	AFCOEFF098	IIR Filter Coefficient Data for SET 0	<a href="#">Section 6.4.12</a>
0x01C7:00B0	AFCOEFF0010	IIR Filter Coefficient Data for SET 0	<a href="#">Section 6.4.13</a>
0x01C7:00B4	AFCOEF110	IIR Filter Coefficient Data for SET 1	<a href="#">Section 6.4.14</a>
0x01C7:00B8	AFCOEF132	IIR Filter Coefficient Data for SET 1	<a href="#">Section 6.4.15</a>
0x01C7:00BC	AFCOEFF154	IIR Filter Coefficient Data for SET 1	<a href="#">Section 6.4.16</a>
0x01C7:00C0	AFCOEFF176	IIR Filter Coefficient Data for SET 1	<a href="#">Section 6.4.17</a>
0x01C7:00C4	AFCOEFF198	IIR Filter Coefficient Data for SET 1	<a href="#">Section 6.4.18</a>
0x01C7:00C8	AFCOEFF1010	IIR Filter Coefficient Data for SET 1	<a href="#">Section 6.4.19</a>
0x01C7:00CC	AEWWIN1	Configuration for AE/AWB Windows	<a href="#">Section 6.4.20</a>
0x01C7:00D0	AEWINSTART	Start Position for AE/AWB Windows	<a href="#">Section 6.4.21</a>
0x01C7:00D4	AEWINBLK	Start Position and Height for Black Line of AE/AWB Windows	<a href="#">Section 6.4.22</a>
0x01C7:00D8	AEWSUBWIN	Configuration for Subsample Data in AE/AWB Window	<a href="#">Section 6.4.23</a>
0x01C7:00DC	AEWBUFST	SDRAM/DDRAM Start Address for AE/AWB Engine Output Data	<a href="#">Section 6.4.24</a>
0x01C7:00E0	RSDR_ADDR	SDRAM/DDRAM Read Address	<a href="#">Section 6.4.25</a>
0x01C7:00E4	RADR_OFFSET	SDRAM/DDRAM Line Offset	<a href="#">Section 6.4.26</a>
0x01C7:00E8	SDR_FRSIZE	Frame Size for SDRAM Read Data	<a href="#">Section 6.4.27</a>

### 6.4.1 Peripheral Revision and Class Information Register (PID)

The peripheral ID register (PID) is shown in [Figure 286](#) and described in [Table 254](#).

**Figure 286. Peripheral Revision and Class Information Register (PID)**



LEGEND: R/W = Read/Write; R = Read only; -n = value after reset

**Table 254. Peripheral ID Register (PID) Field Description**

Bit	Field	Value	Description
31-24	Reserved	0	Reserved. Read as zero.
23-16	TID	0-FFh	Peripheral Identification H3A (AF, AE, and AWB)
15-8	CID	0-FFh	Class Identification VPFE module
7-0	PREV	0-FFh	Peripheral Revision Number Initial Revision



### 6.4.2 Peripheral Control Register (PCR)

The peripheral control register (PCR) is shown in [Figure 287](#) and described in [Table 255](#).

**Figure 287. Peripheral Control Register (PCR)**

	AVE2LMT						
	R/W-1023						
23	22	21	20	19	18	17	16
AVE2LMT	SDR_FETCH_EN	INP_WIDTH	INP_SRC	BUSYAEAWB	AEW_ALAW_EN	AEW_EN	
R/W-1023	R/W-0	R/W-0	R/W-0	R-0	R/W-0	R/W-0	
15	14	13	11	10	8		
BUSYAF	FVMODE	RGBPOS		MED_TH			
R-0	R/W-0	R/W-0		R/W-255			
7	3			2	1	0	
MED_TH				AF_MED_EN	AF_ALAW_EN	AF_EN	
R/W-255				R/W-0	R/W-0	R/W-0	

LEGEND: R/W = Read/Write; R = Read only; -n = value after reset

**Table 255. Peripheral Control Register (PCR) Field Descriptions**

Bit	Field	Value	Description
31-22	AVE2LMT	0-7Fh	AE/AWB Saturation Limit This is the value that all sub sampled pixels in the AE/AWB engine are compared to. If the data is greater or equal to this data then the block is considered saturated.
21	SDR_FETCH_EN	0 1	SDRAM Fetch Enable This bit is used in SDRAM input mode. Set to 1 to begin SDRAM fetch for a frame. Upon completion of frame, it is self-cleared to zero and must then be set to 1 again to initiate the processing of another frame. 0 SDRAM fetch is not active 1 Start SDRAM Fetch for 1 frame
20	INP_WIDTH	0 1	Input Width 0 8-bit packed data (4 pix/ 32 bits) 1 10-bit data (2 pix/32 bits)
19	INP_SRC	0 1	Input Source 0 CCDC (sensor) input 1 SDRAM input
18	BUSYAEAWB	0-1	Busy bit for AE/AWB
17	AEW_ALAW_EN	0 1	AE/AWB A-law Enable 0 Disable AE/AWB A-law table 1 Enable AE/AWB A-law table
16	AEW_EN	0 1	AE/AWB Enable 0 Disable AE/AWB Engine 1 Enable AE/AWB Engine
15	BUSYAF	0-1	Busy bit for AF

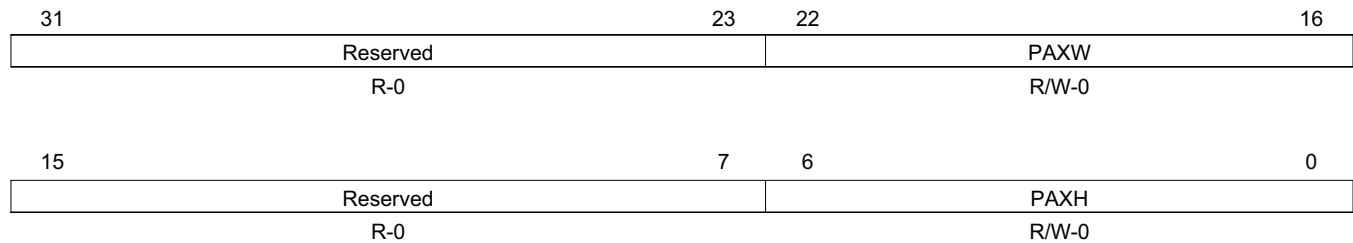
**Table 255. Peripheral Control Register (PCR) Field Descriptions (continued)**

Bit	Field	Value	Description
14	FVMODE	0 1	Focus Value Accumulation Mode Sum Mode Peak Mode
13-11	RGBPOS	0 1 2 3 4 5	Red, Green, and blue pixel location in the AF windows GR and GB as Bayer pattern RG and GB as Bayer pattern GR and BG as Bayer pattern RG and BG as Bayer pattern GG and RB as custom pattern RB and GG as custom pattern
10-3	MED_TH	0-FFh	Median filter threshold
2	AF_MED_EN	0 1	Auto Focus Median filter Enable If the median filter is enabled, then the 1st 2 and last 2 pixels in the frame are not in the valid region. Therefore the paxel start/end and IIR filter start positions should not be set within the 1st and last 2 pixels. Disable Auto Focus median filter Enable Auto Focus median filter
1	AF_ALAW_EN	0 1	Auto Focus A-law table Enable Disable Auto Focus A-law table Enable Auto Focus A-law table
0	AF_EN	0 1	Auto Focus Enable Disable Auto Focus Engine Enable Auto Focus Engine

### 6.4.3 Setup for the AF Engine Poxel Configuration Register (AFPAX1)

The AF engine poxel configuration register (AFPAX1) is shown in [Figure 288](#) and described in [Table 256](#).

**Figure 288. Setup for the AF Engine Poxel Configuration Register (AFPAX1)**



LEGEND: R/W = Read/Write; R = Read only; -n = value after reset

**Table 256. Setup for the AF Engine Poxel Configuration Register (AFPAX1) Field Descriptions**

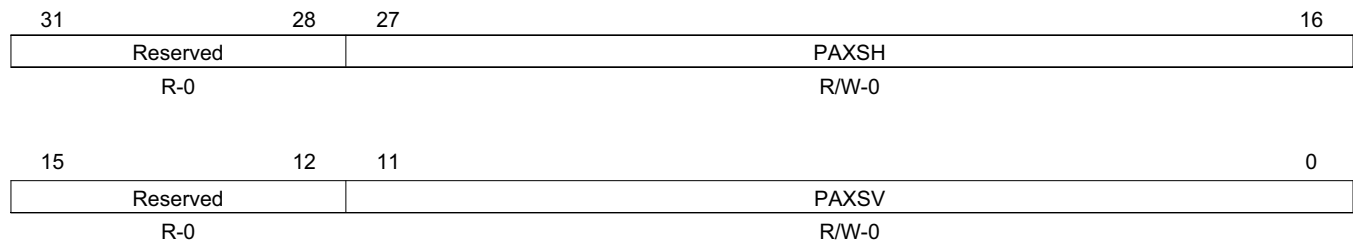
Bit	Field	Value	Description
31-23	Reserved	0	Reserved. Read as zero.
22-16	PAXW	0-7Fh	AF Engine Poxel Width The width of the poxel is the value of this register plus 1 multiplied by 2. The minimum width is expected to be 8 pixels.
15-7	Reserved	0	Reserved. Read as zero.
6-0	PAXH	0-7Fh	AF Engine Poxel Height The height of the poxel is the value of this register plus 1 multiplied by 2 with a final value of 2-256 (even)



### 6.4.5 Start Position for AF Engine Paxels Register (AFPAXSTART)

The start position for AF engine paxels register (AFPAXSTART) is shown in [Figure 290](#) and described in [Table 258](#).

**Figure 290. Start Position for AF Engine Paxels Register (AFPAXSTART)**



LEGEND: R/W = Read/Write; R = Read only; -n = value after reset

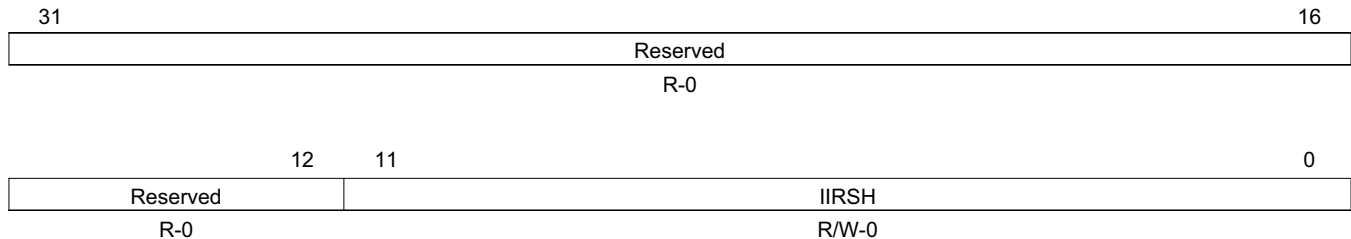
**Table 258. Start Position for AF Engine Paxels Register (AFPAXSTART) Field Descriptions**

Bit	Field	Value	Description
31-28	Reserved	0	Reserved. Read as zero.
27-16	PAXSH	0-FFFh	AF Engine Paxel Horizontal Start Position Range: 2-4094 PAXSH must be equal to or greater than IIRSH + 2 (must be even).
15-12	Reserved	0	Reserved. Read as zero.
11-0	PAXSV	0-FFFh	AF Engine Paxel Vertical Start Position Range: 0-4095 Sets the vertical line for the first paxel.

#### 6.4.6 Start Position for IIRSH Register (AFIIRSH)

The start position for IIRSH register (AFIIRSH) is shown in [Figure 291](#) and described in [Table 259](#).

**Figure 291. Start Position for IIRSH Register (AFIIRSH)**



LEGEND: R = Read only; -n = value after reset

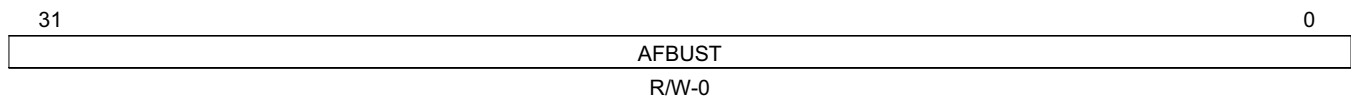
**Table 259. Start Position for IIRSH Register (AFIIRSH) Field Descriptions**

Bit	Field	Value	Description
31-12	Reserved	0	Reserved. Read as zero.
11-0	INITX	0-FFFh	AF Engine IIR Horizontal Start Position Range: 0-4094 When the horizontal position of a line equals this value, the shift registers are cleared on the next pixel (must be even).

#### 6.4.7 SDRAM/DDRAM Start Address for AF Engine Register (AFBUFST)

The SDRAM/DDRAM start address for AF engine register (AFBUFST) is shown in [Figure 292](#) and described in [Table 260](#).

**Figure 292. SDRAM/DDRAM Start Address for AF Engine Register (AFBUFST)**



LEGEND: R/W = Read/Write; R = Read only; -n = value after reset

**Table 260. SDRAM/DDRAM Start Address for AF Engine Register (AFBUFST) Field Descriptions**

Bit	Field	Value	Description
31-0	AFBUST	0-FFFF FFFFh	AF Engine SDRAM/DDRAM Start Address The starting location in the SDRAM/DDRAM. The 6 LSB are ignored, address should be on a 64-byte boundary <b>Note:</b> This field can be altered even when the AF is busy. Change will take place only for the next frame. However, reading this register will always give the latest value.

### 6.4.8 IIR Filter Coefficient Data for SET 0 Register (AFCOEF010)

The IIR filter coefficient data for SET 0 register (AFCOEF010) is shown in [Figure 293](#) and described in [Table 261](#).

**Figure 293. IIR Filter Coefficient Data for SET 0 Register (AFCOEF010)**

31	28	27	16
Reserved		COEFF1	
R-0		R/W-0	
15	12	11	0
Reserved		COEFF0	
R-0		R/W-0	

LEGEND: R/W = Read/Write; R = Read only; -n = value after reset

**Table 261. IIR Filter Coefficient Data for SET 0 Register (AFCOEF010) Field Descriptions**

Bit	Field	Value	Description
31-28	Reserved	0	Reserved. Read as zero.
27-16	COEFF1	0-FFFh	AF Engine IIR Filter Coefficient #1 (Set 0) The range is signed $-32 \leq \text{value} \leq 31 + 63/64$
15-12	Reserved	0	Reserved. Read as zero.
11-0	COEFF0	0-FFFh	AF Engine IIR Filter Coefficient #0 (Set 0) The range is signed $-32 \leq \text{value} \leq 31 + 63/64$

### 6.4.9 IIR Filter Coefficient Data for Set 0 Register (AFCOEF032)

The IIR filter coefficient data for Set 0 register (AFCOEF032) is shown in [Figure 294](#) and described in [Table 262](#).

**Figure 294. IR Filter Coefficient Data for Set 0 Register (AFCOEF032)**

31	28	27	16
Reserved		COEFF3	
R-0		R/W-0	
15	12	11	0
Reserved		COEFF2	
R-0		R/W-0	

LEGEND: R/W = Read/Write; R = Read only; -n = value after reset

**Table 262. IR Filter Coefficient Data for Set 0 Register (AFCOEF032) Field Descriptions**

Bit	Field	Value	Description
31-28	Reserved	0	Reserved. Read as zero.
27-16	COEFF3	0-FFFh	AF Engine IIR filter Coefficient #3 (Set 0) The range is signed $-32 \leq \text{value} \leq 31 + 63/64$
15-12	Reserved	0	Reserved. Read as zero.

**Table 262. IR Filter Coefficient Data for Set 0 Register (AFCOEF032) Field Descriptions (continued)**

Bit	Field	Value	Description
11-0	COEFF2	0-FFFh	AF Engine IIR filter Coefficient #2 (Set 0) The range is signed $-32 \leq \text{value} \leq 31 + 63/64$

#### 6.4.10 IIR Filter Coefficient Data for SET 0 Register (AFCOEFF054)

The IIR filter coefficient data for SET 0 register (AFCOEFF054) is shown in [Figure 295](#) and described in [Table 263](#).

**Figure 295. IIR Filter Coefficient Data for SET 0 Register (AFCOEFF054)**

31	28	27	16
Reserved		COEFF5	
R-0		R/W-0	
15	12	11	0
Reserved		COEFF4	
R-0		R/W-0	

LEGEND: R/W = Read/Write; R = Read only; -n = value after reset

**Table 263. IIR Filter Coefficient Data for SET 0 Register (AFCOEFF054) Field Descriptions**

Bit	Field	Value	Description
31-28	Reserved	0	Reserved. Read as zero.
27-16	COEFF5	0-3FFFh	AF Engine IIR filter Coefficient #5 (Set 0) The range is signed $-32 \leq \text{value} \leq 31 + 63/64$
15-12	Reserved	0	Reserved. Read as zero.
11-0	COEFF4	0-3FFFh	AF Engine IIR filter Coefficient #4 (Set 0) The range is signed $-32 \leq \text{value} \leq 31 + 63/64$

#### 6.4.11 IIR Filter Coefficient Data for SET 0 Register (AFCOEFF076)

The IIR filter coefficient data for SET 0 register (AFCOEFF076) is shown in [Figure 296](#) and described in [Table 264](#).

**Figure 296. IIR Filter Coefficient Data for SET 0 Register (AFCOEFF076)**

31	28	27	16
Reserved		COEFF7	
R-0		R/W-0	
15	12	11	0
Reserved		COEFF6	
R-0		R/W-0	

LEGEND: R/W = Read/Write; R = Read only; -n = value after reset



**Table 264. IIR Filter Coefficient Data for SET 0 Register (AFCOEFF076) Field Descriptions**

Bit	Field	Value	Description
31-28	Reserved	0	Reserved. Read as zero.
27-16	COEFF7	0-FFFh	AF Engine IIR filter Coefficient #7 (Set 0) The range is signed $-32 \leq \text{value} \leq 31 + 63/64$
15-12	Reserved	0	Reserved. Read as zero.
11-0	COEFF6	0-FFFh	AF Engine IIR filter Coefficient #6 (Set 0) The range is signed $-32 \leq \text{value} \leq 31 + 63/64$

#### 6.4.12 IIR Filter Coefficient Data for SET 0 Register (AFCOEFF098)

The IIR filter coefficient data for SET 0 register (AFCOEFF098) is shown in [Figure 297](#) and described in [Table 265](#).

**Figure 297. IIR Filter Coefficient Data for SET 0 Register (AFCOEFF098)**

31	28	27	16
Reserved		COEFF9	
R-0		R/W-0	
15	12	11	0
Reserved		COEFF8	
R-0		R/W-0	

LEGEND: R/W = Read/Write; R = Read only; -n = value after reset

**Table 265. Lens Center (LD) Register (CENTER) Field Descriptions**

Bit	Field	Value	Description
31-28	Reserved	0	Reserved. Read as zero.
27-16	COEFF9	0-FFFh	AF Engine IIR filter Coefficient #9 (Set 0) The range is signed $-32 \leq \text{value} \leq 31 + 63/64$
15-12	Reserved	0	Reserved. Read as zero.
11-0	COEFF8	0-FFFh	AF Engine IIR filter Coefficient #8 (Set 0) The range is signed $-32 \leq \text{value} \leq 31 + 63/64$

#### 6.4.13 IIR Filter Coefficient Data for SET 0 Register (AFCOEFF0010)

The IIR filter coefficient data for SET 0 register (AFCOEFF0010) is shown in [Figure 298](#) and described in [Table 266](#).

**Figure 298. IIR Filter Coefficient Data for SET 0 Register (AFCOEFF0010)**

31	16		
Reserved			
R-0			
15	12	11	0
Reserved		COEFF10	
R-0		R/W-0	

LEGEND: R/W = Read/Write; R = Read only; -n = value after reset

**Table 266. IIR Filter Coefficient Data for SET 0 Register (AFCOEFF0010) Field Descriptions**

Bit	Field	Value	Description
31-12	Reserved	0	Reserved. Read as zero.
11-0	COEFF10	0-FFFh	AF Engine IIR filter Coefficient #10 (Set 0) The range is signed $-32 \leq \text{value} \leq 31 + 63/64$

#### 6.4.14 IIR Filter Coefficient Data for SET 1 Register (AFCOEF110)

The IIR filter coefficient data for SET 1 register (AFCOEF110) is shown in [Figure 299](#) and described in [Table 267](#).

**Figure 299. IIR Filter Coefficient Data for SET 1 Register (AFCOEF110)**

31	28	27	16
Reserved		COEFF1	
R-0		R/W-0	
15	12	11	0
Reserved		COEFF0	
R-0		R/W-0	

LEGEND: R = Read only; -n = value after reset

**Table 267. IIR Filter Coefficient Data for SET 1 Register (AFCOEF110) Field Descriptions**

Bit	Field	Value	Description
31-28	Reserved	0	Reserved. Read as zero.
27-16	COEFF1	0-FFFh	AF Engine IIR Filter Coefficient #1(Set 1) The range is signed $-32 \leq \text{value} \leq 31 + 63/64$
15-12	Reserved	0	Reserved. Read as zero.
11-0	COEFF0	0-FFFh	AF Engine IIR Filter Coefficient #0 (Set 1) The range is signed $-32 \leq \text{value} \leq 31 + 63/64$

#### 6.4.15 IIR Filter Coefficient Data for SET 1 Register (AFCOEF132)

The IIR filter coefficient data for SET 1 register (AFCOEF132) is shown in [Figure 300](#) and described in [Table 268](#).

**Figure 300. IIR Filter Coefficient Data for SET 1 Register (AFCOEF132)**

31	28	27	16
Reserved		COEFF3	
R-0		R/W-0	
15	12	11	0
Reserved		COEFF2	
R-0		R/W-0	

LEGEND: R/W = Read/Write; R = Read only; -n = value after reset

**Table 268. IIR Filter Coefficient Data for SET 1 Register (AFCOEF132) Field Descriptions**

Bit	Field	Value	Description
31-28	Reserved	0	Reserved. Read as zero.
27-16	COEFF3	0-FFFh	AF Engine IIR filter Coefficient #3 (Set 1) The range is signed $-32 \leq \text{value} \leq 31 + 63/64$
15-12	Reserved	0	Reserved. Read as zero.

**Table 268. IIR Filter Coefficient Data for SET 1 Register (AFCOEF132) Field Descriptions (continued)**

Bit	Field	Value	Description
11-0	COEFF2	0-FFFh	AF Engine IIR filter Coefficient #2 (Set 1) The range is signed $-32 \leq \text{value} \leq 31 + 63/64$

#### 6.4.16 IIR Filter Coefficient Data for SET 1 Register (AFCOEFF154)

The IIR filter coefficient data for SET 1 register (AFCOEFF154) is shown in [Figure 301](#) and described in [Table 269](#).

**Figure 301. IIR Filter Coefficient Data for SET 1 Register (AFCOEFF154)**

31	28	27	16
Reserved		COEFF5	
R-0		R/W-0	
15	12	11	0
Reserved		COEFF4	
R-0		R/W-0	

LEGEND: R/W = Read/Write; R = Read only; -n = value after reset

**Table 269. IIR Filter Coefficient Data for SET 1 Register (AFCOEFF154) Field Descriptions**

Bit	Field	Value	Description
31-28	Reserved	0	Reserved. Read as zero.
27-16	COEFF5	0-FFFh	AF Engine IIR filter Coefficient #5 (Set 1) The range is signed $-32 \leq \text{value} \leq 31 + 63/64$
15-12	Reserved	0	Reserved. Read as zero.
11-0	COEFF4	0-FFFh	AF Engine IIR Filter Coefficient #4 (Set 1) The range is signed $-32 \leq \text{value} \leq 31 + 63/64$

#### 6.4.17 IIR Filter Coefficient Data for SET 1 Register (AFCOEFF176)

The IIR filter coefficient data for SET 1 register (AFCOEFF176) is shown in [Figure 302](#) and described in [Table 270](#).

**Figure 302. IIR Filter Coefficient Data for SET 1 Register (AFCOEFF176)**

31	28	27	16
Reserved		COEFF7	
R-0		R/W-0	
15	12	11	0
Reserved		COEFF6	
R-0		R/W-0	

LEGEND: R/W = Read/Write; R = Read only; -n = value after reset

**Table 270. IIR Filter Coefficient Data for SET 1 Register (AFCOEFF176) Field Descriptions**

Bit	Field	Value	Description
31-28	Reserved	0	Reserved. Read as zero.

**Table 270. IIR Filter Coefficient Data for SET 1 Register (AFCOEFF176) Field Descriptions (continued)**

Bit	Field	Value	Description
27-16	COEFF7	0-FFFh	AF Engine IIR Filter Coefficient #7 (Set 1) The range is signed $-32 \leq \text{value} \leq 31 + 63/64$
15-12	Reserved	0	Reserved. Read as zero.
11-0	COEFF6	0-FFFh	AF Engine IIR Filter Coefficient #6 (Set 1) The range is signed $-32 \leq \text{value} \leq 31 + 63/64$

#### 6.4.18 IIR Filter Coefficient Data for SET 1 Register (AFCOEFF198)

The IIR filter coefficient data for SET 1 register (AFCOEFF198) is shown in [Figure 303](#) and described in [Table 271](#).

**Figure 303. IIR Filter Coefficient Data for SET 1 Register (AFCOEFF198)**

31	28	27	16
Reserved		COEFF9	
R-0		R/W-0	
15	12	11	0
Reserved		COEFF8	
R-0		R/W-0	

LEGEND: R/W = Read/Write; R = Read only; -n = value after reset

**Table 271. IIR Filter Coefficient Data for SET 1 Register (AFCOEFF198) Field Descriptions**

Bit	Field	Value	Description
31-28	Reserved	0	Reserved. Read as zero.
27-16	COEFF9	0-FFFh	AF Engine IIR Filter Coefficient #9 (Set 1) The range is signed $-32 \leq \text{value} \leq 31 + 63/64$
15-12	Reserved	0	Reserved. Read as zero.
11-0	COEFF8	0-FFFh	AF Engine IIR Filter Coefficient #8 (Set 1) The range is signed $-32 \leq \text{value} \leq 31 + 63/64$

#### 6.4.19 IIR Filter Coefficient Data for SET 1 Register (AFCOEFF1010)

The IIR filter coefficient data for SET 1 register (AFCOEFF1010) is shown in [Figure 304](#) and described in [Table 272](#).

**Figure 304. IIR Filter Coefficient Data for SET 1 Register (AFCOEFF1010)**

31	16
Reserved	
R-0	
15	0
Reserved	
R-0	
COEFF10	
R/W-0	

LEGEND: R/W = Read/Write; R = Read only; -n = value after reset

**Table 272. IIR Filter Coefficient Data for SET 1 Register (AFCOEFF1010) Field Descriptions**

Bit	Field	Value	Description
31-12	Reserved	0	Reserved. Read as zero.
11-0	COEFF10	0-FFFh	AF Engine IIR filter Coefficient #10 (Set 1) The range is signed $-32 \leq \text{value} \leq 31 + 63/64$

### 6.4.20 Configuration for AE/AWB Windows Register (AEWWIN1)

The configuration for AE/AWB windows register (AEWWIN1) is shown in [Figure 305](#) and described in [Table 273](#).

**Figure 305. Configuration for AE/AWB Windows Register (AEWWIN1)**

31	30	24	23	20	19	16
Rsvd	WINH	Reserved		WINW		
R-0	R/W-0	R-0		R/W-0		
15	13	12	6	5	0	
WINW		WINVC			WINHC	
R/W-0		R/W-0			R/W-0	

LEGEND: R/W = Read/Write; R = Read only; -n = value after reset

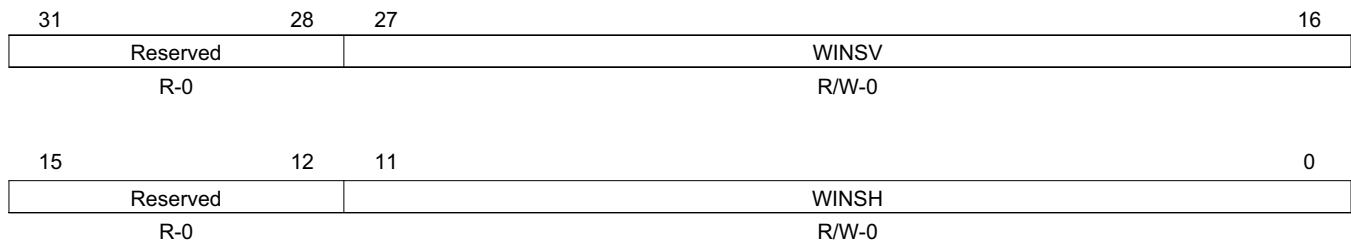
**Table 273. Configuration for AE/AWB Windows Register (AEWWIN1) Field Descriptions**

Bit	Field	Value	Description
31	Reserved	0	Reserved. Read as zero.
30-24	WINH	0-7Fh	AE/AWB Engine Window Height This specifies the window height in an even number of pixels, the window height is the value plus 1 multiplied by 2. The final value can be from 2-256 (even).
23-20	Reserved	0	Reserved. Read as zero.
19-13	WINW	0-7Fh	AE/AWB Engine Window Width This specifies the window width in an even number of pixels, the window width is the value plus 1 multiplied by 2. The minimum width is expected to be 8 pixels.
12-6	WINVC	0-7Fh	AE/AWB Engine Vertical Window Count The number of windows in the vertical direction plus 1. The maximum number of vertical windows in a frame should not exceed 128. The value should be set to ensure that the bandwidth requirements and buffer size are not exceeded.
5-0	WINHC	0-3Fh	AE/AWB Engine Horizontal Window Count The number of horizontal windows plus 1. The maximum number of horizontal windows is 35 plus 1 (36). The minimum number of windows should be 2 (valid range for the field is 1-35).

### 6.4.21 Start Position for AE/AWB Windows Register (AEWINSTART)

The start position for AE/AWB windows register (AEWINSTART) is shown in [Figure 306](#) and described in [Table 274](#).

**Figure 306. Start Position for AE/AWB Windows Register (AEWINSTART)**



LEGEND: R/W = Read/Write; R = Read only; -n = value after reset

**Table 274. Start Position for AE/AWB Windows Register (AEWINSTART) Field Descriptions**

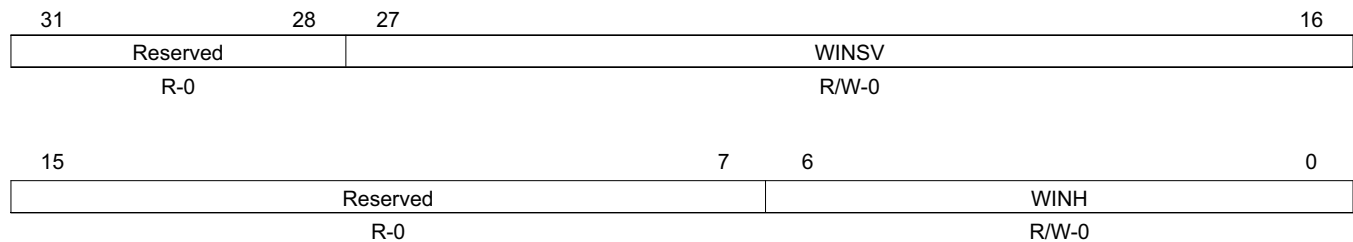
Bit	Field	Value	Description
31-28	Reserved	0	Reserved. Read as zero.
27-16	WINSV	0-FFFh	AE/AWB Engine Vertical Window Start Position Sets the first line for the first window. Range 0-4095
15-12	Reserved	0	Reserved. Read as zero.
11-0	WINSH	0-FFFh	AE/AWB Engine Horizontal Window Start Position Sets the horizontal position for the first window on each line. Range: 0-4095



### 6.4.22 Start Position and Height for Black Line of AE/AWB Windows Register (AEWINBLK)

The start position and height for black line of AE/AWB windows register (AEWINBLK) is shown in [Figure 307](#) and described in [Table 275](#).

**Figure 307. Start Position and Height for Black Line of AE/AWB Windows Register (AEWINBLK)**



LEGEND: R/W = Read/Write; R = Read only; -n = value after reset

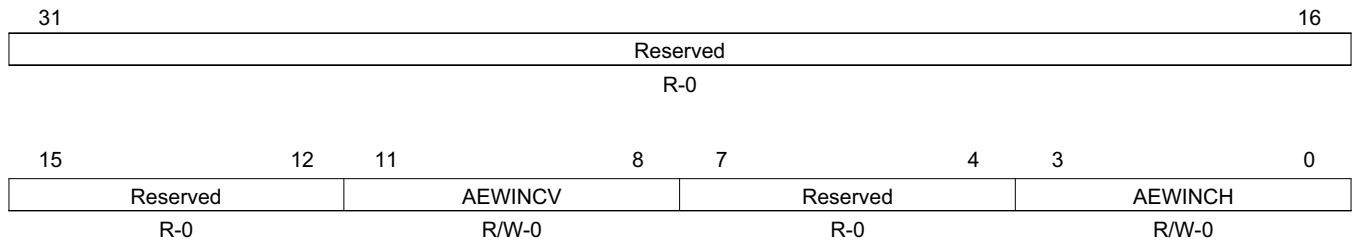
**Table 275. Start Position and Height for Black Line of AE/AWB Windows Register (AEWINBLK)  
Field Descriptions**

Bit	Field	Value	Description
31-28	Reserved	0	Reserved. Read as zero.
27-16	WINSV	0-FFFh	AE/AWB Engine Vertical Window Start Position for single black line of windows. Sets the first line for the first window. Range: 0 - 4095 <b>Note:</b> the horizontal start and the horizontal number of windows will be similar to the regular windows.
15-7	Reserved	0	Reserved. Read as zero.
6-0	WINH	0-7Fh	AE/AWB Engine Window Height for the single black line of windows. This specifies the window height in an even number of pixels, the window height is the value plus 1 multiplied by 2. The final value can be from 2 - 256 (must be even).

### 6.4.23 Configuration for Subsample Data in AE/AWB Window Register (AEWSUBWIN)

The configuration for subsample data in AE/AWB window register (AEWSUBWIN) is shown in [Figure 308](#) and described in [Table 276](#).

**Figure 308. Configuration for Subsample Data in AE/AWB Window Register (AEWSUBWIN)**



LEGEND: R/W = Read/Write; R = Read only; -n = value after reset

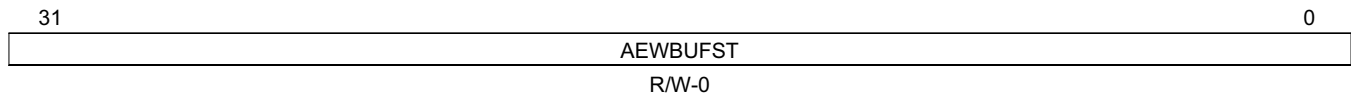
**Table 276. Configuration for Subsample Data in AE/AWB Window Register (AEWSUBWIN)  
Field Descriptions**

Bit	Field	Value	Description
31-12	Reserved	0	Reserved. Read as zero.
11-8	AEWINCV	0-Fh	AE/AWB Engine Vertical Sampling Point Increment Sets vertical distance between sub-samples within a window plus 1 multiplied by 2. The final range is 2-32.
7-4	Reserved	0	Reserved. Read as zero.
3-0	AEWINCH	0-Fh	AE/AWB Engine Horizontal Sampling Point Increment Sets horizontal distance between sub-samples within a window plus 1 multiplied by 2. The final range is 2-32.

#### 6.4.24 SDRAM/DDRAM Start Address for AE/AWB Engine Output Data Register (AEWBUFST)

The SDRAM/DDRAM start address for AE/AWB engine output data register (AEWBUFST) is shown in [Figure 309](#) and described in [Table 277](#).

**Figure 309. SDRAM/DDRAM Start Address for AE/AWB Engine Output Data Register (AEWBUFST)**



LEGEND: R/W = Read/Write; R = Read only; -n = value after reset

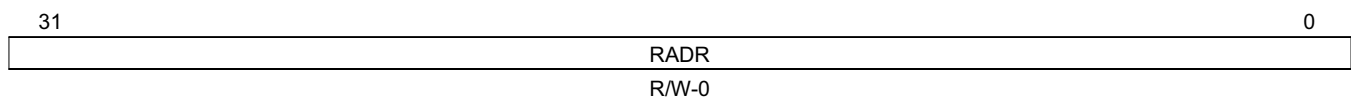
**Table 277. SDRAM/DDRAM Start Address for AE/AWB Engine Output Data Register (AEWBUFST) Field Descriptions**

Bit	Field	Value	Description
31-0	AEWBUFST	0-FFFF FFFFh	<p>AE/AWB Engine SDRAM/DDRAM Start Address The starting location in the SDRAM/DDRAM for the AE/AWB data. The 6 LSB are ignored, address should be on a 64-byte boundary</p> <p><b>Note:</b> This field can be altered even when the AE/AWB is busy. Change will take place only for the next frame. However, note that reading this register will always give the latest value.</p>

#### 6.4.25 SDRAM/DDRAM Read Address for AE/AWB Engine Register (RSDR\_ADDR)

The SDRAM/DDRAM read address for AE/AWB engine register (RSDR\_ADDR) is shown in [Figure 310](#) and described in [Table 278](#).

**Figure 310. SDRAM/DDRAM Read Address for AE/AWB Engine Register (RSDR\_ADDR)**



LEGEND: R/W = Read/Write; R = Read only; -n = value after reset

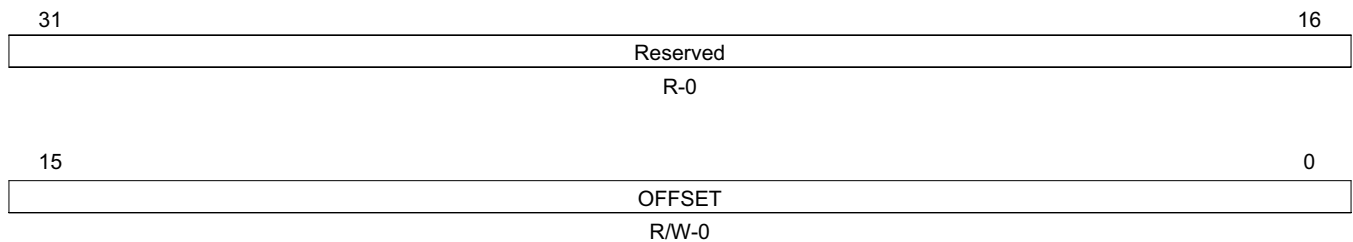
**Table 278. SDRAM/DDRAM Read Address for AE/AWB Engine Register (RSDR\_ADDR) Field Descriptions**

Bit	Field	Value	Description
31-0	RADR	0-FFFF FFFFh	<p>Read Address</p> <p>Specifies the initial address of the frame that is to be fetched from SDRAM. The lower 5 bits of this register are always treated as zeroes - the starting address should be 32-byte aligned.</p> <p><b>Note:</b> This field can be altered even when the H3A is busy. Change will take place only for the next frame. However, note that reading this register will always give the latest value.</p>

### 6.4.26 Line Offset for the Read Data Register (RADR\_OFFSET)

The line offset for the read data register (RADR\_OFFSET) is shown in [Figure 311](#) and described in [Table 279](#).

**Figure 311. Line Offset for the Read Data Register (RADR\_OFFSET)**



LEGEND: R/W = Read/Write; R = Read only; -n = value after reset

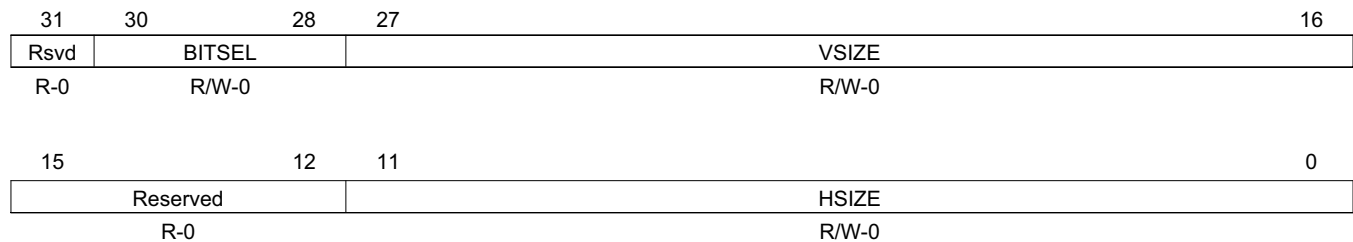
**Table 279. Line Offset for the Read Data Register (RADR\_OFFSET) Field Descriptions**

Bit	Field	Value	Description
31-16	Reserved	0	Reserved. Read as zero.
15-0	OFFSET	0-FFFFh	Line offset Specifies the offset for each line relative to the previous line. The lower 5 bits of this register are always treated as zeroes - the offset should be 32-byte aligned. <b>Note:</b> This field can be altered even when the H3A is busy. Change will take place only for the next frame. However, note that reading this register will always give the latest value.

### 6.4.27 Frame Size for SDRAM Read Data Register (SDR\_FRSIZE)

The frame size for SDRAM read data register (SDR\_FRSIZE) is shown in [Figure 312](#) and described in [Table 280](#).

**Figure 312. Frame Size for SDRAM Read Data Register (SDR\_FRSIZE)**



LEGEND: R/W = Read/Write; R = Read only; -n = value after reset

**Table 280. Frame Size for SDRAM Read Data Register (SDR\_FRSIZE) Field Descriptions**

Bit	Field	Value	Description
31	Reserved	0	Reserved. Read as zero.
30-28	BITSEL		Bit Selection 10 bits from 16 bit SDRAM word
		0	(BITS9_0) 9:0 from 15:0 input
		1	(BITS10_1) 10:1 from 15:0 input
		2	(BITS11_2) 11:2 from 15:0 input
		3	(BITS12_3) 12:3 from 15:0 input
		4	(BITS13_4) 13:4 from 15:0 input
		5	(BITS14_5) 14:5 from 15:0 input
		6	(BITS15_6) 15:6 from 15:0 input
		7	Reserved
27-16	VSIZE	0-FFFh	Number of lines to fetch from SDRAM for the frame
15-12	Reserved	0	Reserved. Read as zero.
11-0	HSIZE	0-7Fh	Number of pixels to fetch for each line for SDRAM The number of bytes to fetch depends on whether input source is 8-bits or 10-bits.

## 6.5 VPSS Buffer Logic Registers (VPSSBL)

The VPSS Buffer Logic Registers (VPSSBL) are shown in [Table 281](#).

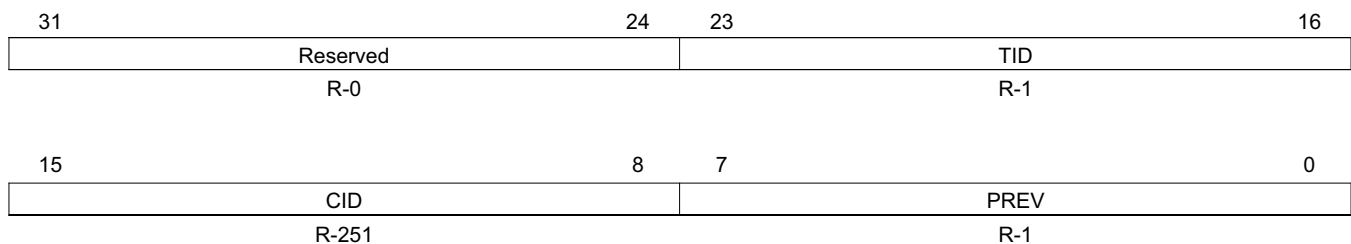
**Table 281. VPSS Buffer Logic Register Map (VPSSBL)**

Address	Acronym	Register Description	Section
0x01C7:0800	PID	Peripheral Revision and Class Information	<a href="#">Section 6.5.1</a>
0x01C7:0804	PCR	Peripheral Control Register	<a href="#">Section 6.5.2</a>
0x01C7:080C	INTSTAT	Interrupt Status Register	<a href="#">Section 6.5.3</a>
0x01C7:0810	INTSEL	Interrupt Selection Register	<a href="#">Section 6.5.4</a>
0x01C7:0814	EVTSEL	Event Selection Register	<a href="#">Section 6.5.5</a>
0x01C7:0818	MEMCTRL	Shared Memory Master Select	<a href="#">Section 6.5.6</a>

### 6.5.1 Peripheral Revision and Class Information Register (PID)

The peripheral revision and class information register (PID) is shown in [Figure 313](#) and described in [Table 282](#).

**Figure 313. Peripheral Revision and Class Information Register (PID)**



LEGEND: R/W = Read/Write; R = Read only; -n = value after reset

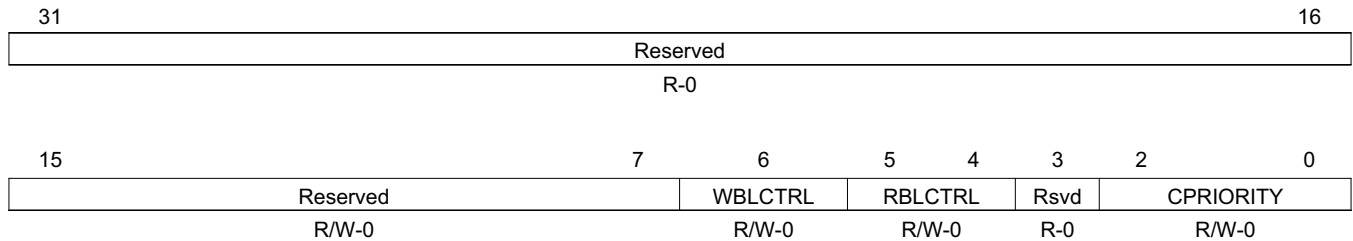
**Table 282. Peripheral ID Register (PID) Field Description**

Bit	Field	Value	Description
31-24	Reserved	0	Reserved. Read as zero.
23-16	TID	0-FFh	Peripheral Identification VPSSBL
15-8	CID	0-FFh	Class Identification VPSS module
7-0	PREV	0-FFh	Peripheral Revision Number Initial Revision

### 6.5.2 Peripheral Control Register (PCR)

The peripheral control register (PCR) is shown in [Figure 314](#) and described in [Table 283](#).

**Figure 314. Peripheral Control Register (PCR)**



LEGEND: R/W = Read/Write; R = Read only; -n = value after reset

**Table 283. Peripheral Control Register (PCR) Field Descriptions**

Bit	Field	Value	Description
31-7	Reserved	0	Read as zero.
6	WBLCTRL	0 1	Select DDR2/mDDR controller Write Master IPIPE Reserved
5-4	RBLCTRL	0 1 2	Select DDR2/mDDR controller Read Master IPIPEIF Reserved H3A
3	Reserved	0	Read as zero.
2-0	CPRIORITY	0-7	Sets Priority of VPSS Should be set to highest priority (0) for best performance

### 6.5.3 Interrupt Status Register (INTSTAT)

The interrupt status register (INTSTAT) is shown in [Figure 315](#) and described in [Table 284](#).

**Figure 315. Interrupt Status Register (INTSTAT)**

31	Reserved								16
R-0									
15	Reserved		13	12	11	10	9	8	
R-0			IPIPE_IN T5	IPIPE_INT4	IPIPE_INT3	IPIPE_INT2	IPIPE_INT1		
R-0			R/W-0	R/W-0	R/W-0	R/W-0	R/W-0	R/W-0	
7	6	5	4	3	2	1	0		
IPIPE_INT0	IPIPEIFINT	OSDINT	VENCINT	H3AINT	CCDC_VDINT2	CCDC_VDINT1	CCDC_VDINT0		
R/W-0	R/W-0	R/W-0	R/W-0	R/W-0	R/W-0	R/W-0	R/W-0	R/W-0	

LEGEND: R/W = Read/Write; R = Read only; -n = value after reset

**Table 284. Interrupt Status Register (INTSTAT) Field Descriptions**

Bit	Field	Value	Description
31-13	Reserved	0	Reserved. Read as zero.
12	IPIPE_INT5	1	Set when IPIPE_INT5 is triggered, clear by writing 1. Clear bit
11	IPIPE_INT4	1	Set when IPIPE_INT4 is triggered, clear by writing 1. Clear bit
10	IPIPE_INT3	1	Set when IPIPE_INT3 is triggered, clear by writing 1. Clear bit
9	IPIPE_INT2	1	Set when IPIPE_INT2 is triggered, clear by writing 1. Clear bit
8	IPIPE_INT1	1	Set when IPIPE_INT1 is triggered, clear by writing 1. Clear bit
7	IPIPE_INT0	1	Set when IPIPE_INT0 is triggered, clear by writing 1. Clear bit
6	IPIPEIFINT	1	Set when IPIPEIFINT is triggered, clear by writing 1. Clear bit
5	OSDINT	1	Set when OSDINT is triggered, clear by writing 1. Clear bit
4	VENCINT	1	Set when VENCINT is triggered, clear by writing 1. Clear bit
3	H3AINT	1	Set when H3AINT is triggered, clear by writing 1. Clear bit
2	CCDC_VDINT2	1	Set when CCDC_VDINT2 is triggered, clear by writing 1. Clear bit
1	CCDC_VDINT1	1	Set when CCDC_VDINT1 is triggered, clear by writing 1. Clear bit
0	CCDC_VDINT0	1	Set when CCDC_VDINT0 is triggered, clear by writing 1. Clear bit





### 6.5.4 Interrupt Selection Register (INTSEL)

The interrupt selection register (INTSEL) is shown in [Figure 316](#) and described in [Table 285](#).

**Figure 316. Interrupt Selection Register (INTSEL)**

31	28	27	24	23	20	19	16	
INTSEL7			INTSEL6			INTSEL5		INTSEL4
R/W-7			R/W-6			R/W-5		R/W-4
15	12	11	8	7	4	3	0	
INTSEL3			INTSEL2			INTSEL1		INTSEL0
R/W-3			R/W-2			R/W-1		R/W-0

LEGEND: R/W = Read/Write; R = Read only; -n = value after reset

**Table 285. Interrupt Selection Register (INTSEL) Field Descriptions**

Bit	Field	Value	Description
31-28	INTSEL7		Selects the interrupt for vpss_int[7]
		0	CCDC VDINT0
		1	CCDC VDINT1
		2	CCDC VDINT2
		3	H3AINT
		4	VENCINT
		5	OSDINT
		6	IPIPEIFINT
		7	IPIPE_INT0_HST
		8	IPIPE_INT1_SDR
		9	IPIPE_INT2_RZA
		10	IPIPE_INT3_RZB
		12	IPIPE_INT5_MMR
27-24	INTSEL6	0-Fh	Selects the interrupt for vpss_int[6]
23-20	INTSEL5	0-Fh	Selects the interrupt for vpss_int[5]
19-16	INTSEL4	0-Fh	Selects the interrupt for vpss_int[4]
15-12	INTSEL3	0-Fh	Selects the interrupt for vpss_int[3]
11-8	INTSEL2	0-Fh	Selects the interrupt for vpss_int[2]
7-4	INTSEL1	0-Fh	Selects the interrupt for vpss_int[1]
3-0	INTSEL1	0-Fh	Selects the interrupt for vpss_int[1]

### 6.5.5 Event Selection Register (EVTSEL)

The event selection register (EVTSEL) is shown in [Figure 317](#) and described in [Table 286](#).

**Figure 317. Event Selection Register (EVTSEL)**

31	28	27	24	23	20	19	16
EVTSEL3		EVTSEL2		EVTSEL1		EVTSEL0	
R-13		R/W-11		R/W-8		R/W-3	
						4	3
15	Reserved					INTSEL8	
R-0					R/W-8		

LEGEND: R/W = Read/Write; R = Read only; -n = value after reset

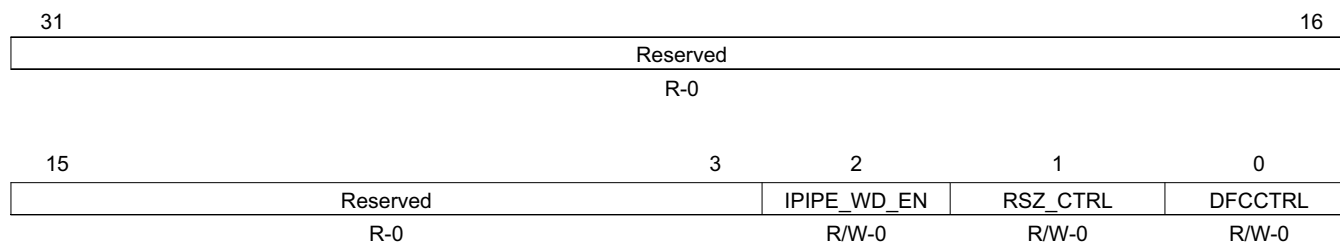
**Table 286. Event Selection Register (EVTSEL) Field Descriptions**

Bit	Field	Value	Description
31-28	EVTSEL3	0	CCDC VDINT0
		1	CCDC VDINT1
		2	CCDC VDINT2
		3	H3AINT
		4	VENCINT
		5	OSDINT
		6	IPIPEIFINT
		7	IPIPE_INT0_HST
		8	IPIPE_INT1_SDR
		9	IPIPE_INT2_RZA
		10	IPIPE_INT3_RZB
		12	IPIPE_INT5_MMR
		27-24	EVTSEL2
23-20	EVTSEL1	0-Fh	Selects the event for vpss_evt[1]
19-16	EVTSEL0	0-Fh	Selects the event for vpss_evt[0]
15-4	Reserved	0	Reserved. Read as zero.
3-0	INTSEL8	0-Fh	Selects the interrupt for vpss_int[8]

### 6.5.6 Shared Memory Master Select Register (MEMCTRL)

The shared memory master select register (MEMCTRL) is shown in [Figure 318](#) and described in [Table 287](#).

**Figure 318. Shared Memory Master Select Register (MEMCTRL)**



LEGEND: R = Read only; -n = value after reset

**Table 287. Shared Memory Master Select Register (MEMCTRL) Field Descriptions**

Bit	Field	Value	Description
31-3	Reserved	0	Reserved. Read as zero.
2	IPIPE_WD_EN	0 1	IPIPE Write Address Word Enable Enable the IPIPE to write to any addresses. When disabled, the IPIPE can only write to 32-byte starting addresses. 0 Enable 1 Disable
1	RSZ_CTRL	0 1	Resizer Memory Select 0 IPIPE 1 Reserved
0	DFCCTRL	0 1	Defect Correction Memory Select 0 IPIPE 1 CCDC

## 6.6 VPSS Clock Control Registers (VPSSCLK)

The VPSS Clock Control Registers (VPSSCLK) are shown in [Table 288](#).

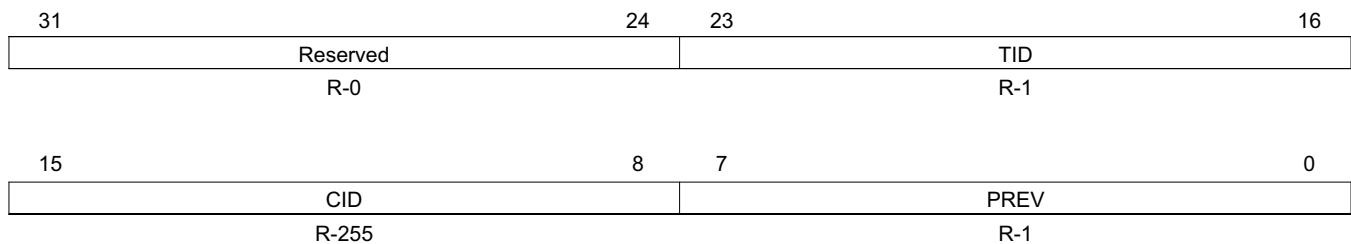
**Table 288. VPSS Clock Control Register Map (VPSSCLK)**

Address	Acronym	Register Description	Section
0x01C7:0000	PID	Peripheral Revision and Class Information	<a href="#">Section 6.6.1</a>
0x01C7:0004	CLKCTRL	VPSS Clock Control Register	<a href="#">Section 6.6.2</a>

### 6.6.1 Peripheral Revision and Class Information Register (PID)

The peripheral ID register (PID) is shown in [Figure 319](#) and described in [Table 289](#).

**Figure 319. Peripheral Revision and Class Information Register (PID)**



LEGEND: R = Read only; -n = value after reset

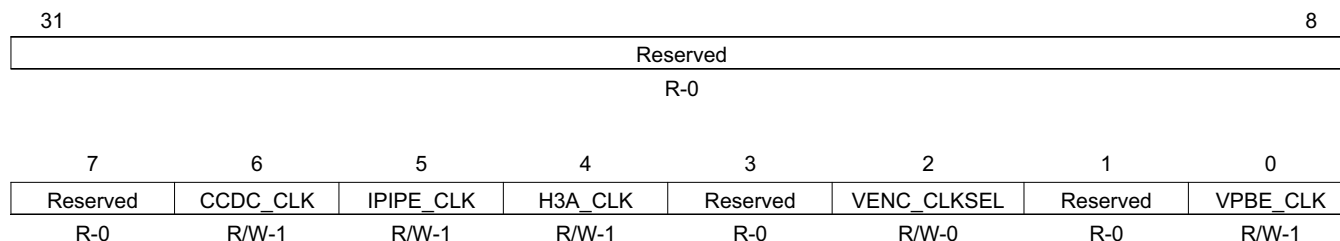
**Table 289. Peripheral ID Register (PID) Field Description**

Bit	Field	Value	Description
31-24	Reserved	0	Reserved. Read as zero.
23-16	TID	0-FFh	Peripheral Identification VPSS
15-8	CID	0-FFh	Class Identification VPSS module
7-0	PREV	0-FFh	Peripheral Revision Number Initial Revision

## 6.6.2 VPSS Clock Control Register (CLKCTRL)

The VPSS clock control register (CLKCTRL) is shown in [Figure 320](#) and described in [Table 290](#).

**Figure 320. VPSS Clock Control Register (CLKCTRL)**



LEGEND: R/W = Read/Write; R = Read only; -n = value after reset

**Table 290. VPSS Clock Control Register (CLKCTRL) Field Descriptions**

Bit	Field	Value	Description
31-7	Reserved	0	Reserved. Read as zero.
6	CCDC_CLK	0	Clock off
		1	Clock on
5	IPIPE_CLK	0	Clock off
		1	Clock on
4	H3A_CLK	0	Clock off
		1	Clock on
3	Reserved	0	Reserved. Read as zero.
2	VENC_CLKSEL	0	enc clk
		1	enc clk/2
1	Reserved	0	Reserved. Read as zero.
0	VPBE_CLK	0	Clock off
		1	Clock on

## Appendix A Revision History

This document has been changed from SPRUF71 to SPRUF71A because of the following technical change(s).

**Table A-1. Changes Made in This Revision**

Location	Additions, Deletions, Changes
<a href="#">Section 4.1.2</a> and <a href="#">Section 4.1.3</a>	Changed both occurrences of SYN_MODE.INPMODE to MODESET.INPMOD
<a href="#">Table 22</a>	Changed the order of and value of the Boxcar function to 2 and the YCbCR to 3.

## IMPORTANT NOTICE

Texas Instruments Incorporated and its subsidiaries (TI) reserve the right to make corrections, modifications, enhancements, improvements, and other changes to its products and services at any time and to discontinue any product or service without notice. Customers should obtain the latest relevant information before placing orders and should verify that such information is current and complete. All products are sold subject to TI's terms and conditions of sale supplied at the time of order acknowledgment.

TI warrants performance of its hardware products to the specifications applicable at the time of sale in accordance with TI's standard warranty. Testing and other quality control techniques are used to the extent TI deems necessary to support this warranty. Except where mandated by government requirements, testing of all parameters of each product is not necessarily performed.

TI assumes no liability for applications assistance or customer product design. Customers are responsible for their products and applications using TI components. To minimize the risks associated with customer products and applications, customers should provide adequate design and operating safeguards.

TI does not warrant or represent that any license, either express or implied, is granted under any TI patent right, copyright, mask work right, or other TI intellectual property right relating to any combination, machine, or process in which TI products or services are used. Information published by TI regarding third-party products or services does not constitute a license from TI to use such products or services or a warranty or endorsement thereof. Use of such information may require a license from a third party under the patents or other intellectual property of the third party, or a license from TI under the patents or other intellectual property of TI.

Reproduction of TI information in TI data books or data sheets is permissible only if reproduction is without alteration and is accompanied by all associated warranties, conditions, limitations, and notices. Reproduction of this information with alteration is an unfair and deceptive business practice. TI is not responsible or liable for such altered documentation. Information of third parties may be subject to additional restrictions.

Resale of TI products or services with statements different from or beyond the parameters stated by TI for that product or service voids all express and any implied warranties for the associated TI product or service and is an unfair and deceptive business practice. TI is not responsible or liable for any such statements.

TI products are not authorized for use in safety-critical applications (such as life support) where a failure of the TI product would reasonably be expected to cause severe personal injury or death, unless officers of the parties have executed an agreement specifically governing such use. Buyers represent that they have all necessary expertise in the safety and regulatory ramifications of their applications, and acknowledge and agree that they are solely responsible for all legal, regulatory and safety-related requirements concerning their products and any use of TI products in such safety-critical applications, notwithstanding any applications-related information or support that may be provided by TI. Further, Buyers must fully indemnify TI and its representatives against any damages arising out of the use of TI products in such safety-critical applications.

TI products are neither designed nor intended for use in military/aerospace applications or environments unless the TI products are specifically designated by TI as military-grade or "enhanced plastic." Only products designated by TI as military-grade meet military specifications. Buyers acknowledge and agree that any such use of TI products which TI has not designated as military-grade is solely at the Buyer's risk, and that they are solely responsible for compliance with all legal and regulatory requirements in connection with such use.

TI products are neither designed nor intended for use in automotive applications or environments unless the specific TI products are designated by TI as compliant with ISO/TS 16949 requirements. Buyers acknowledge and agree that, if they use any non-designated products in automotive applications, TI will not be responsible for any failure to meet such requirements.

Following are URLs where you can obtain information on other Texas Instruments products and application solutions:

### Products

Audio	<a href="http://www.ti.com/audio">www.ti.com/audio</a>
Amplifiers	<a href="http://amplifier.ti.com">amplifier.ti.com</a>
Data Converters	<a href="http://dataconverter.ti.com">dataconverter.ti.com</a>
DLP® Products	<a href="http://www.dlp.com">www.dlp.com</a>
DSP	<a href="http://dsp.ti.com">dsp.ti.com</a>
Clocks and Timers	<a href="http://www.ti.com/clocks">www.ti.com/clocks</a>
Interface	<a href="http://interface.ti.com">interface.ti.com</a>
Logic	<a href="http://logic.ti.com">logic.ti.com</a>
Power Mgmt	<a href="http://power.ti.com">power.ti.com</a>
Microcontrollers	<a href="http://microcontroller.ti.com">microcontroller.ti.com</a>
RFID	<a href="http://www.ti-rfid.com">www.ti-rfid.com</a>
RF/IF and ZigBee® Solutions	<a href="http://www.ti.com/lprf">www.ti.com/lprf</a>

### Applications

Communications and Telecom	<a href="http://www.ti.com/communications">www.ti.com/communications</a>
Computers and Peripherals	<a href="http://www.ti.com/computers">www.ti.com/computers</a>
Consumer Electronics	<a href="http://www.ti.com/consumer-apps">www.ti.com/consumer-apps</a>
Energy and Lighting	<a href="http://www.ti.com/energy">www.ti.com/energy</a>
Industrial	<a href="http://www.ti.com/industrial">www.ti.com/industrial</a>
Medical	<a href="http://www.ti.com/medical">www.ti.com/medical</a>
Security	<a href="http://www.ti.com/security">www.ti.com/security</a>
Space, Avionics and Defense	<a href="http://www.ti.com/space-avionics-defense">www.ti.com/space-avionics-defense</a>
Transportation and Automotive	<a href="http://www.ti.com/automotive">www.ti.com/automotive</a>
Video and Imaging	<a href="http://www.ti.com/video">www.ti.com/video</a>
Wireless	<a href="http://www.ti.com/wireless-apps">www.ti.com/wireless-apps</a>

TI E2E Community Home Page

[e2e.ti.com](http://e2e.ti.com)

Mailing Address: Texas Instruments, Post Office Box 655303, Dallas, Texas 75265  
Copyright © 2011, Texas Instruments Incorporated