

2.4 GHz YAGI PCB Antenna

By Richard Wallace & Steve Dunbar

Keywords

- *Antenna Selection*
- *Directional Antenna*
- *Yagi PCB Antenna*
- *2.4 GHz Antenna*
- *OTA Measurements*
- *CC2xxx*
- *CC8520*

1 Introduction

This application note describes a 2.4 GHz Yagi PCB Directional Antenna that can be used with any 2.4 GHz radio reference design that has a 50 ohm RF interface.

Figure 1 shows the 2.4 GHz Yagi PCB Directional Antenna test board. The size of the board is 100 x 150 mm.

The bandwidth, impedance and OTA measurement results are presented in this document. Complete OTA CTIA measurements are included in the appendices section.

This antenna design is one of the several antenna reference designs available on www.ti.com/lpw and is included in the Comprehensive Antenna Selection Guide [1] and the Antenna Selection Quick Guide [7].

Pros and cons of directional antennas are mentioned and the correct choice of antenna will improve system performance.

With special thanks to Luke Sankey and the University of Colorado for their assistance in making this design note possible.

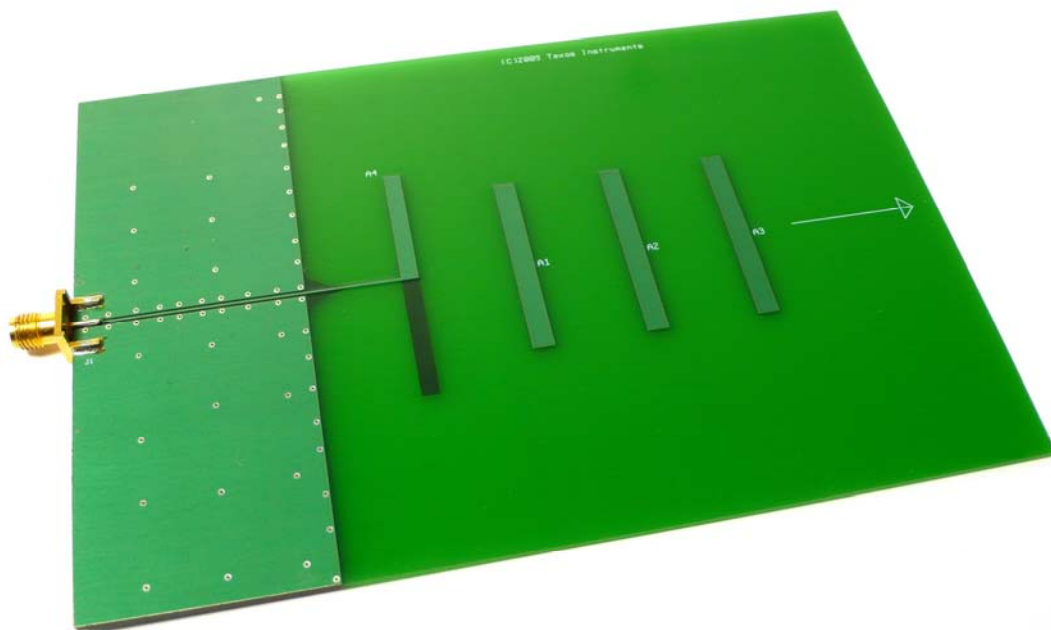

Figure 1. 2.4 GHz Yagi PCB Directional Antenna Test Board

Table of Contents

KEYWORDS	1
1 INTRODUCTION	1
2 ABBREVIATIONS	2
3 BOARD DESCRIPTION	3
3.1 IMPLEMENTATION OF THE 2.4 GHZ YAGI PCB DIRECTIONAL ANTENNA	4
4 MEASUREMENTS	5
4.1 S ₁₁ MEASUREMENTS	5
4.1.1 Bandwidth	5
4.1.2 Impedance	6
4.2 RADIATION PATTERN	7
4.3 OTA TEST RESULTS FOR 2400 MHZ, 2440 MHZ & 2480 MHZ	8
5 SUMMARY	9
6 REFERENCES	10
7 GENERAL INFORMATION	10
7.1 DOCUMENT HISTORY	10
8 APPENDICES	11
8.1 OTA TEST RESULTS FOR FREQUENCY 2400.000 MHZ	11
8.2 OTA TEST RESULTS FOR FREQUENCY 2440.000 MHZ	17
8.3 OTA TEST RESULTS FOR FREQUENCY 2480.000 MHZ	23

2 Abbreviations

AN	Application Note
AUT	Antenna Under Test
CPW	CoPlanar Waveguide
CTIA	Cellular Telecommunications Industry Association
DK	Development Kit
DN	Design Note
EB	Evaluation Board
EIRP	Effective Isotropic Radiated Power
EM	Electro Magnetic
EM	Evaluation Module
IFA	Inverted-F Antenna
ISM	Industrial, Scientific, Medical
LOS	Line of Sight
NHPRP	Near Horizon Partial Radiated Power
NHPRP45	Near Horizon Partial Radiated Power within 45 degrees angle
OTA	Over The Air
PCB	Printed Circuit Board
RF	Radio Frequency
RL	Return Loss
SWR	Standing Wave Ratio
TI	Texas Instruments
TRP	Total Radiated Power
VSWR	Voltage Standing Wave Ratio
YAGI	Directional Antenna (Original invented by YAGI & UDA)

3 Board Description

The antenna described in this document is a Yagi-Uda commonly named as Yagi and is a directional antenna with approximately 7dBi gain. Impedance of the antenna input is 50Ω which allows easy matching to most networks.

Since PCB vendors manufacturing processes, customer board thickness and application board surroundings vary it is a safe option to include a pi-filter network at the feed point. If the pi-filter network is not required then a zero ohm resistor can be inserted. The compensating network allows for detuning caused by enclosing the antenna in plastic and other objects in close vicinity of the antenna. For further information on impedance matching and impedance measurements, refer to AN058 [1].

Bandwidth and the impedance measurements are shown in Section 4.1. Radiation pattern is shown in Section 4.2.

The printed Yagi antenna shown in Figure 2 was designed with a 3D magnetic simulator for antennas. The antenna has a single ended feed input of 50Ω and this single ended transmission line is converted to a two-wire feed via the integrated balun, as shown in the red circle in Figure 2 and Figure 5.

The feed dipole element is fed with a two-wire transmission line, and the ground plane, printed on all four layers of the PCB, acts as the reflector. The arms of the feed dipole element are printed on separate layers; the bottom arm stays on the second (Internal, Antenna Bottom) layer, see Figure 4 and Figure 6; while the top arm and all of the directors reside on the top layer (Top, Antenna Top), see Figure 3 and Figure 6.

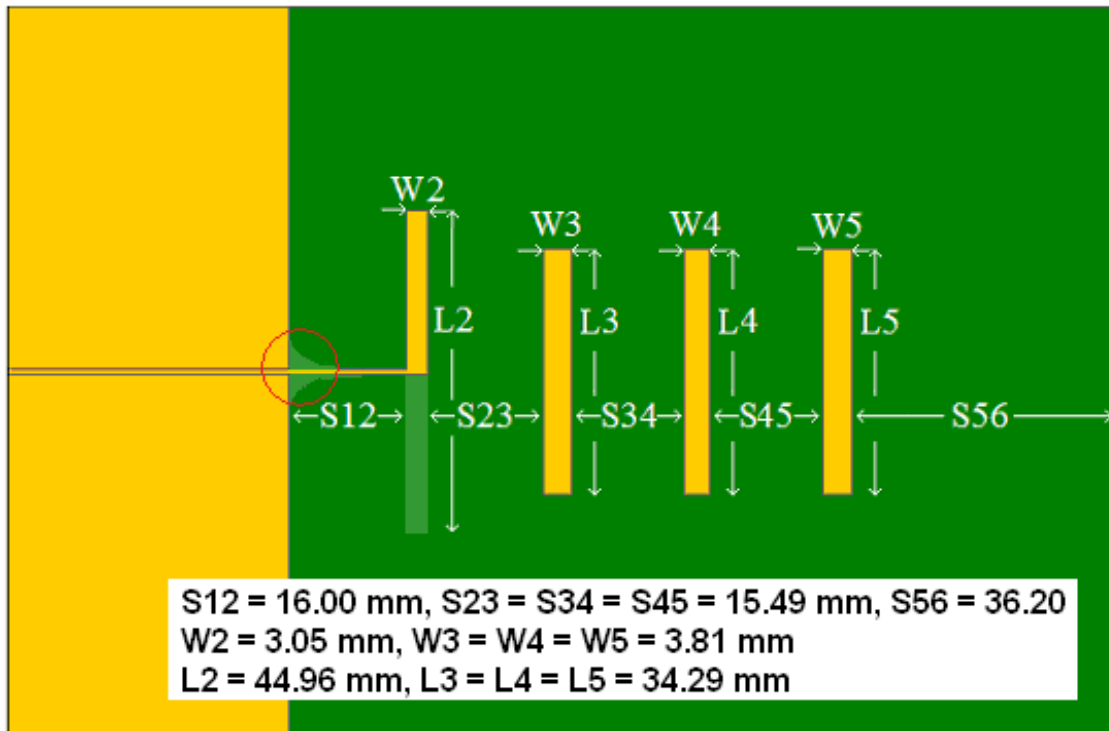

Figure 2. 2.4 GHz Yagi PCB Directional Antenna Dimensions

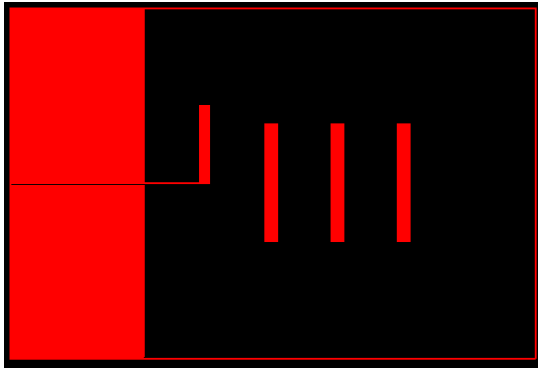

Figure 3. Layer 3 (Top, Antenna Top Layer)

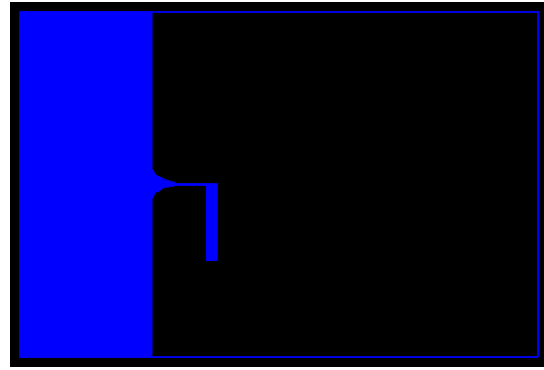

Figure 4. Layer 2 (Inner, Antenna Bottom Layer)

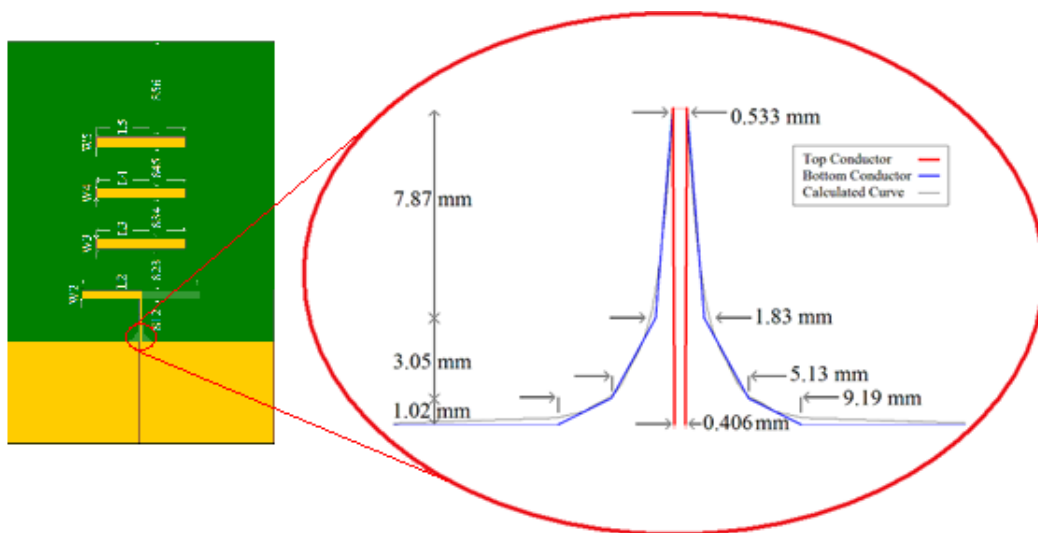

Figure 5. Balun Transition from 50 Ω Microstrip Line to 50 Ω two wire dipole feed

There is a printed balun in the Yagi antenna design and this can be seen in the red circle in Figure 2 and Figure 5; this is required to feed the 50 Ω two wire dipole (Top, Antenna Top Layer) from a 50 Ω microstrip line (Inner, Antenna Bottom Layer). The balun consists of three sections with a narrowing linear taper shown in more detail in Figure 5.

3.1 Implementation of the 2.4 GHz Yagi PCB Directional Antenna

To obtain optimum performance it is important to make an exact copy of the antenna dimensions. Total area of the antenna is 100 mm by 150 mm (4" by 6"). The antenna design is based upon 2 layers (Antenna Top & Antenna Bottom) of a 4-layer standard, FR4, PCB, 1.6mm (62 mils) stack-up, refer to Figure 6.

A standard 4-layer PCB stack-up was used to incorporate the antenna design on layers 3 & 2; layers 1 & 0 should not be used for routing underneath the antenna but can be used for routing of other sections of the application board design. There is a possibility to port the design to another multi-layer stack-up providing that the distance between Antenna Top and Antenna Bottom is kept the same (226 μ m); this has not yet been tested but should be feasible.

It is important for the antenna operation to keep the exact dimensions sizes shown in Figure 2, including the extra PCB material around the antenna.

One approach to implement the antenna in a PCB CAD tool is to import the antenna layout from a Gerber file. Such a file is included in the 2.4 GHz Yagi PCB Directional Antenna Reference Design [2]. If the CAD tool being used does not support import of Gerber files, the dimensions included in Figure 2 and Figure 5 can be used.

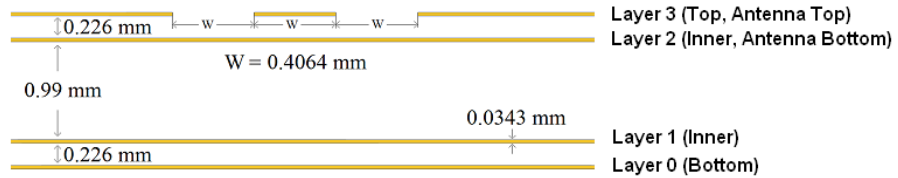

Figure 6. 2 Layer Antenna Design based on a 4 Layer, 1.6mm PCB Stack-Up

4 Measurements

4.1 S₁₁ Measurements

4.1.1 Bandwidth

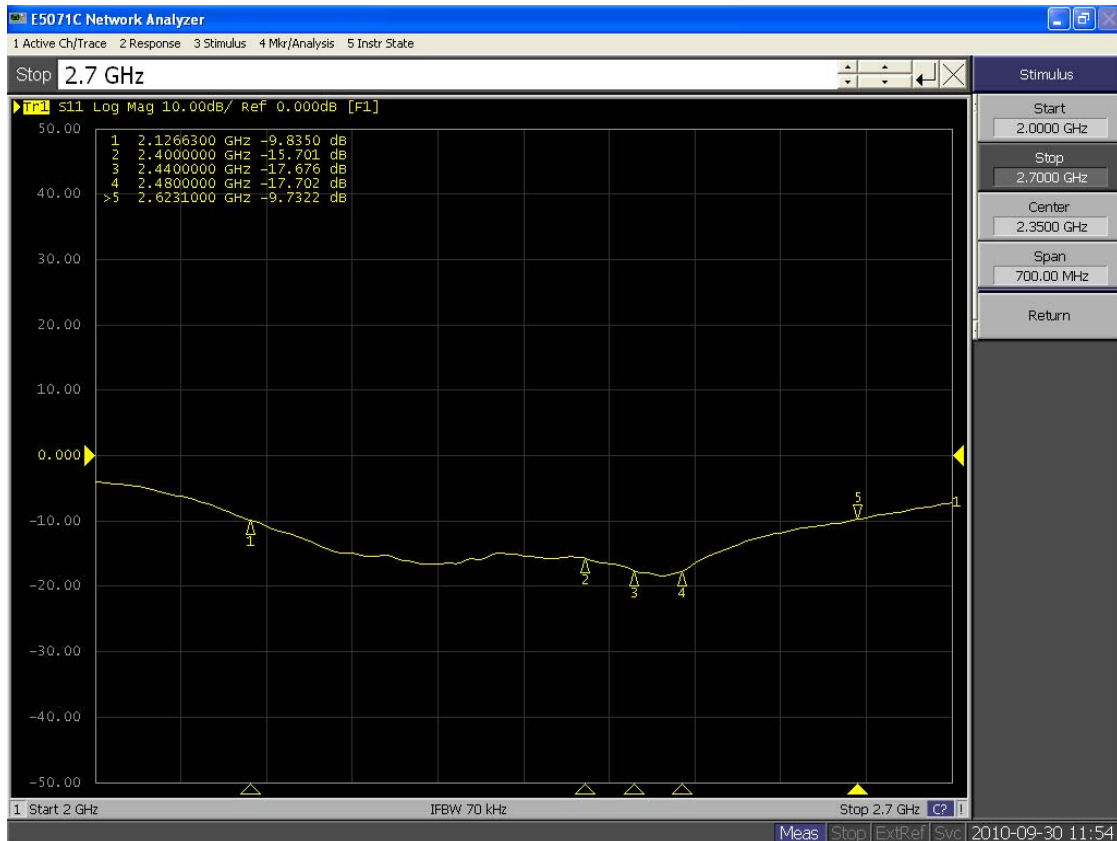

Figure 7. Bandwidth Measurement

Referring to Figure 7, bandwidth is measured at -10dB return loss point (VSWR of 2.0):

$$\text{Bandwidth} = 2623 \text{ MHz}_{(\text{Marker } 5)} - 2126 \text{ MHz}_{(\text{Marker } 1)} = 497 \text{ MHz}$$

4.1.2 Impedance

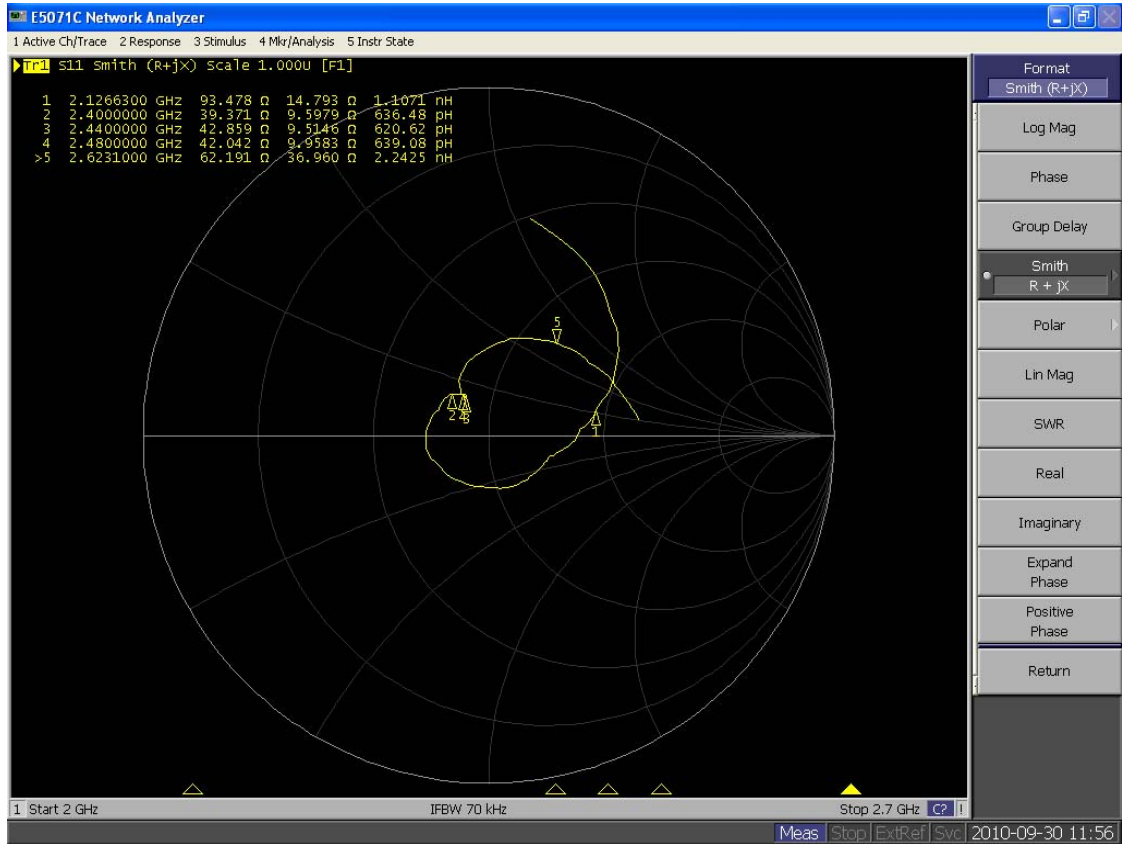

Figure 8. 2.4 GHz Yagi Antenna Test Board 4L, 1.6mm - PCB Stack-Up

Referring to Figure 8, the impedance match for 2.40 GHz_(Marker 2), 2.44 GHz_(Marker 3) & 2.48 GHz_(Marker 4) is good and within VSWR of 1.4. This good match can be seen when the wanted frequency markers (2.40 GHz_(Marker 2), 2.44 GHz_(Marker 3) & 2.48 GHz_(Marker 4)) are in the centre of the Smith chart.

4.2 Radiation Pattern

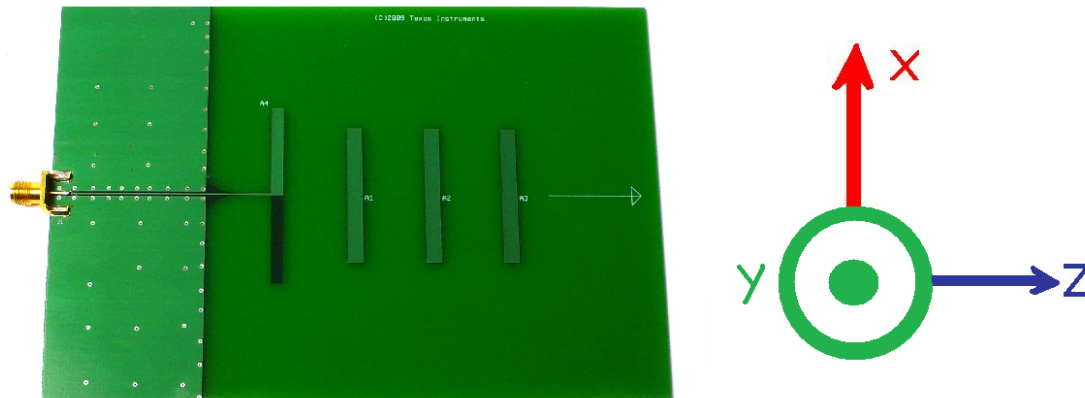

Figure 9. 3D Coordinates for Radiation Patterns

Figure 9 illustrates the coordinates of the 2.4 GHz Yagi antenna test board for the radiation patterns generated from the OTA measurements. The complete OTA measurements are shown in the Appendices Section [8]. Measurements were performed at 2400.000 MHz [8.1], 2440.000 MHz [8.2] and at 2480.000 MHz [8.3].

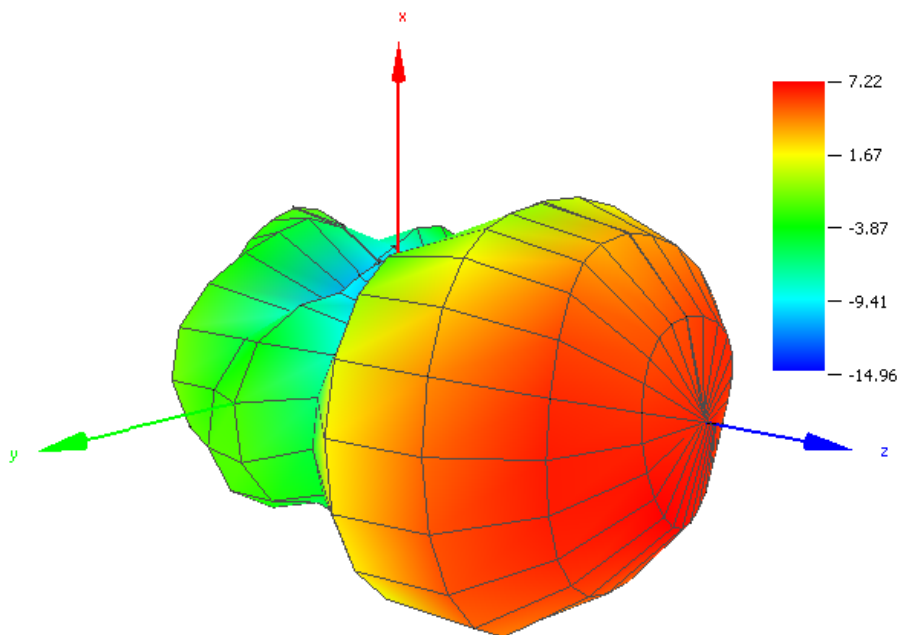

Figure 10. 3D Radiation Pattern at 2400.000 MHz

The radiation pattern for Yagi antenna can be seen in Figure 10. It can be clearly seen that the main focus of energy is directed in the Z plane. The colours relate to the radiation output power and the scale can be seen in the top, right section of Figure 10. The gain at 2400.000 MHz was recorded at 7.22 dBi.

More radiation patterns are shown in the Appendices Section [8].

4.3 OTA Test Results for 2400 MHz, 2440 MHz & 2480 MHz

Frequency	2400.000 MHz	2440.000 MHz	2480.000 MHz
Total Radiated Power	-0.70 dBm	-1.44 dBm	-2.35 dBm
Peak EIRP	7.22 dBm	7.18 dBm	7.13 dBm
Directivity	7.92 dBi	8.62 dBi	9.48 dBi
Efficiency	-0.70 dB	-1.44 dB	-2.35 dB
Efficiency	85.20 %	71.70 %	58.24 %
Gain	7.22 dBi	7.18 dBi	7.13 dBi
NHPRP 45°	-4.58 dBm	-5.88 dBm	-6.97 dBm
NHPRP 45° / TRP	-3.88 dB	-4.43 dB	-4.63 dB
NHPRP 45° / TRP	40.90 %	36.05 %	34.46 %
NHPRP 30°	-7.69 dBm	-9.28 dBm	-9.25 dBm
NHPRP 30° / TRP	-7.00 dB	-7.83 dB	-6.90 dB
NHPRP 30° / TRP	19.96 %	16.48 %	20.41 %
NHPRP 22.5°	-9.23 dBm	-10.81 dBm	-10.40 dBm
NHPRP 22.5° / TRP	-8.53 dB	-9.37 dB	-8.06 dB
NHPRP 22.5° / TRP	14.02 %	11.57 %	15.65 %
UHRP	-1.59 dBm	-2.22 dBm	-3.28 dBm
UHRP / TRP	-0.90 dB	-0.77 dB	-0.93 dB
UHRP / TRP	81.34 %	83.68 %	80.71 %
LHRP	-7.99 dBm	-9.32 dBm	-9.49 dBm
LHRP / TRP	-7.29 dB	-7.87 dB	-7.15 dB
LHRP / TRP	18.66 %	16.32 %	19.29 %
Front/Back Ratio	14.16	15.77	15.25
PhiBW	360.0 deg	360.0 deg	360.0 deg
PhiBW Up	360.0 deg	360.0 deg	360.0 deg
PhiBW Down	360.0 deg	360.0 deg	360.0 deg
ThetaBW	82.1 deg	76.0 deg	63.6 deg
ThetaBW Up	33.5 deg	29.3 deg	33.5 deg
ThetaBW Down	48.6 deg	46.7 deg	30.1 deg
Boresight Phi	135 deg	135 deg	240 deg
Boresight Theta	15 deg	15 deg	0 deg
Maximum Power	7.22 dBm	7.18 dBm	7.13 dBm
Minimum Power	-14.96 dBm	-16.28 dBm	-16.81 dBm
Average Power	1.17 dBm	0.85 dBm	0.39 dBm
Max/Min Ratio	22.18 dB	23.46 dB	23.94 dB
Max/Avg Ratio	6.05 dB	6.33 dB	6.75 dB
Min/Avg Ratio	-16.13 dB	-17.13 dB	-17.20 dB
Best Single Value	6.82 dBm	6.65 dBm	6.85 dBm
Best Position	Phi = 180 deg; Theta = 0 deg; Pol = Hor	Phi = 90 deg; Theta = 0 deg; Pol = Ver	Phi = 90 deg; Theta = 0 deg; Pol = Ver

Table 1. OTA Test Results for 2400 MHz, 2440 MHz & 2480 MHz

As can be seen from Table 1, the gain of the antenna is similar across the whole 2.4 GHz ISM band. The efficiency is highest at 2400 MHz and as the frequency increases the efficiency drops slightly.

For an explanation of each measurement result, please refer to the Antenna Selection Guide, AN058 [1].

5 Summary

Antenna gain is just a measure of the antenna directivity and an antenna can only ever radiated the power that is entered into the antenna. No amplification is achieved via high gain antennas. When the antenna gain characteristic increases, the main radiation lobe becomes longer and narrower (more directive).

Typically for a system with mobile units it is desirable to have an omni-directional radiation pattern such that the performance will be approximately the same regardless of which direction the units are pointed relative to each other. A concern of using directional antennas is that the positioning of the transmitter and receiver unit must be known in detail. If this information is not known then it is could be better to consider to use a more omni-directional antenna design such as the inverted-F antenna [3]. If the positioning of the transmitter and receiver unit is fixed then this directional antenna is an excellent choice.

To assist in the decision which antenna should be used the Comprehensive Antenna Selection Guide is available [1]. The Antenna Selection Quick Guide [7] is also available and is shown in Figure 11.



















Antenna Selection Quick Guide								DN035
								
Design / Application Note	DN007	AN043	DN004	AN040	DN024	DN034	AN048	
Frequency	2.4 GHz	2.4 GHz	2.4 GHz	2.4 GHz	2.4 GHz	2.4 GHz	2.4 GHz	
Typical Efficiency	80 %(EB) 94 %(SA)	68 %(EB)	80 %(EB)	80 %(EB)	76 %(EB) 87 %(SA)	72 %(SA)	55 %(USB)	
Bandwidth @ VSWR 2:0	280 MHz	101 MHz	100 MHz	80 MHz	400 MHz	497 MHz	150 MHz	
Dimensions (mm)	26 x 8	15 x 6	46 x 9	48 x 8	39 x 25	150 x 100	7 x 3	
								
Design / Application Note	DN024	DN023	DN031	DN031	DN033	DN031	DN016	
Frequency	868 / 915 / 955 MHz	868 / 915 / 955 MHz	868 / 915 / 955 MHz	868 / 915 / 955 MHz	868 / 915 / 955 MHz	868 / 915 / 955 MHz	868 / 915 / 955 MHz	
Typical Efficiency	64 %(EB) 91 %(SA)	80 %(SA)	89 %(EB)	64 %(EB)	48 %(EB)	63 %(EB)	20 %(EB)	
Bandwidth @ VSWR 2:0	46 MHz	40 MHz	62 MHz	58 MHz	56 MHz	8 MHz	21 MHz	
Dimensions (mm)	39 x 25	43 x 20	10 x 28	48 x 8	15 x (5 to 29)	10 x 14	9 x 8	
								
Design / Application Note	DN031	DN031	DN031	DN031	DN031			
Frequency	433 MHz	433 MHz	433 MHz	315 MHz	136 - 240 MHz			
Typical Efficiency	20 %(EB)	26 %(EB)	15 %(EB)	15 %(EB)	7 %(EB)			
Bandwidth @ VSWR 2:0	23 MHz	38 MHz	30 MHz	4 MHz	3 MHz			
Dimensions (mm)	37 x 9	42 x (10 to 28)	15 x (5 to 28)	37 x 9	42 x (22 to 28)			
EB: Standard Evaluation Board SA: Stand Alone		SWRA351		By Richard Wallace				

Figure 11. DN035 – Antenna Selection Quick Guide

The gain of the YAGI antenna shown in Figure 1 is approx 7 dBi, compared to a more omni-directional antenna with a gain in the region of approx 2 dBi. Theoretically, by increasing the gain 6 dB, the effective range distance will be doubled in a specific direction.

Applications environments such as corridor coverage, metering surveillance, and maximum range distance between two fixed devices can be ideal applications for the directional type of antennas since the antenna gain can be utilized to achieve a greater range distance between two devices.

Another advantage of using a directional antenna is the PA power can be reduced due to the higher gain in the antenna between two devices for a given distance so that current consumption can be reduced.

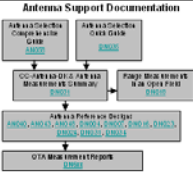
6 References

- [1] AN058 – Antenna Selection guide ([swra161.pdf](#))
- [2] 2.4 GHz Yagi PCB Directional Antenna Reference Design ([swrr074.zip](#))
- [3] DN007 - 2.4 GHz Inverted-F Antenna ([swru120.pdf](#))
- [4] DN018 - Range Measurements in an Open Field Environment ([swra169.pdf](#))
- [5] DN031 – CC-Antenna-DK Documentation and Antenna Measurements Summary ([swra328.pdf](#))
- [6] CC-Antenna-DK Rev 1.0.0. Reference Design ([swrr070.zip](#))
- [7] DN035 – Antenna Selection Quick Guide ([swra351.pdf](#))

7 General Information

7.1 Document History

Revision	Date	Description/Changes
SWRA350	2010-10-14	Initial release.

8 Appendices

8.1 OTA Test Results for Frequency 2400.000 MHz

RP_2400.000_tot

Azimuth (deg)	Elevation 0 deg (dB)	Elevation 15 deg (dB)	Elevation 30 deg (dB)	Elevation 45 deg (dB)	Elevation 60 deg (dB)	Elevation 75 deg (dB)	Elevation 90 deg (dB)	Elevation 105 deg (dB)
0.00	6.34	5.60	3.71	-0.44	-7.12	-13.92	-10.52	-10.06
15.00	6.50	5.45	3.37	-0.59	-7.15	-12.82	-9.89	-10.98
30.00	6.62	5.45	3.96	0.19	-5.35	-11.29	-9.80	-11.27
45.00	6.66	5.60	4.89	1.53	-2.60	-10.31	-9.40	-10.73
60.00	6.63	5.87	5.74	2.83	-0.47	-9.29	-6.71	-8.43
75.00	6.53	6.19	6.35	4.18	1.12	-8.14	-3.93	-5.18
90.00	6.40	6.50	6.67	4.95	1.89	-6.42	-2.31	-3.18
105.00	6.22	6.81	6.67	5.44	2.22	-5.08	-2.16	-2.09
120.00	6.21	7.09	6.47	5.52	2.05	-4.49	-3.17	-2.33
135.00	6.34	7.22	6.08	5.10	1.30	-4.76	-5.74	-3.82
150.00	6.55	7.17	5.70	4.43	0.40	-6.19	-8.59	-5.97
165.00	6.73	7.01	5.26	3.44	-0.72	-8.17	-11.68	-8.78
180.00	6.88	6.76	5.08	2.58	-1.58	-9.96	-12.65	-11.89
195.00	7.01	6.47	5.05	2.02	-1.94	-9.53	-11.06	-13.90
210.00	7.04	6.21	5.17	2.00	-1.49	-8.30	-8.36	-9.05
225.00	7.03	5.93	5.41	2.31	-0.46	-6.77	-5.74	-4.69
240.00	6.97	5.81	5.54	2.72	0.26	-5.39	-3.63	-1.91
255.00	6.79	5.79	5.64	3.14	0.50	-4.30	-2.95	-0.26
270.00	6.56	5.95	5.64	3.41	0.31	-3.90	-3.13	0.34
285.00	6.40	6.18	5.46	3.37	-0.23	-4.87	-4.22	-0.17
300.00	6.31	6.32	5.20	2.94	-0.98	-6.90	-5.93	-1.48
315.00	6.27	6.36	4.81	2.36	-2.25	-9.86	-8.17	-3.87
330.00	6.25	6.24	4.32	1.56	-3.76	-12.40	-10.12	-6.26
345.00	6.33	5.95	3.78	0.60	-5.45	-14.32	-11.02	-8.82
360.00	6.47	5.63	3.63	-0.27	-6.63	-14.96	-10.44	-9.92

(continuation of the "RP_2400.000_tot" table from column 9 ...)

Azimuth (deg)	Elevation 120 deg (dB)	Elevation 135 deg (dB)	Elevation 150 deg (dB)	Elevation 165 deg (dB)	Elevation 180 deg (dB)
0.00	-6.46	-2.04	-4.80	-6.86	-7.72
15.00	-5.05	-2.65	-6.29	-7.60	-8.25
30.00	-4.74	-3.07	-7.12	-8.26	-8.73
45.00	-3.91	-3.48	-7.23	-8.93	-9.60
60.00	-2.67	-3.36	-7.00	-9.63	-10.02
75.00	-1.52	-3.20	-6.51	-10.34	-10.43
90.00	-1.21	-3.31	-6.50	-10.59	-10.24
105.00	-1.91	-3.46	-6.53	-10.07	-9.71
120.00	-3.50	-3.98	-6.59	-9.39	-8.79
135.00	-6.36	-4.76	-7.00	-8.34	-7.85
150.00	-9.04	-5.87	-7.12	-7.68	-7.33
165.00	-11.10	-6.47	-7.32	-7.41	-7.32
180.00	-10.83	-5.97	-7.04	-7.33	-7.68
195.00	-9.97	-4.84	-5.88	-7.77	-8.14
210.00	-9.29	-4.59	-4.67	-8.18	-8.81
225.00	-7.87	-4.59	-4.02	-8.53	-10.06
240.00	-6.80	-4.73	-4.14	-8.72	-10.97
255.00	-5.58	-4.75	-4.52	-9.23	-11.03
270.00	-5.31	-4.43	-4.84	-8.80	-11.29
285.00	-5.72	-4.20	-5.08	-8.08	-10.07
300.00	-6.47	-3.74	-4.77	-7.35	-9.28
315.00	-7.63	-3.13	-4.35	-6.94	-8.16
330.00	-8.25	-2.38	-4.17	-6.66	-7.63
345.00	-7.65	-1.89	-4.42	-6.61	-7.40
360.00	-6.24	-1.90	-5.31	-6.66	-7.67

Application Note DNO34

RP_2400.000_hor

Azimuth (deg)	Elevation 0 deg (dB)	Elevation 15 deg (dB)	Elevation 30 deg (dB)	Elevation 45 deg (dB)	Elevation 60 deg (dB)	Elevation 75 deg (dB)	Elevation 90 deg (dB)	Elevation 105 deg (dB)
0.0	6.27	5.49	3.46	-0.71	-7.93	-16.99	-11.57	-11.21
15.0	6.30	5.39	3.27	-0.70	-7.87	-16.80	-10.72	-12.37
30.0	5.71	4.78	3.02	-0.98	-8.46	-17.95	-11.37	-13.49
45.0	4.37	3.44	2.18	-2.04	-9.34	-21.03	-12.66	-14.82
60.0	2.16	1.13	0.49	-4.07	-10.74	-18.04	-12.52	-13.77
75.0	-1.88	-3.61	-3.08	-8.62	-13.53	-15.60	-11.96	-13.72
90.0	-10.32	-14.43	-10.69	-20.13	-16.96	-13.70	-12.17	-14.99
105.0	-9.13	-6.13	-10.51	-7.69	-11.11	-12.17	-13.86	-18.18
120.0	-1.23	-0.01	-2.41	-2.50	-6.92	-10.67	-15.70	-21.03
135.0	2.82	3.46	1.55	0.36	-4.15	-9.66	-15.66	-19.43
150.0	5.00	5.24	3.52	1.75	-2.78	-9.78	-14.59	-18.92
165.0	6.28	6.29	4.56	2.37	-2.12	-10.00	-14.16	-18.25
180.0	6.82	6.61	4.96	2.31	-1.97	-10.55	-13.77	-17.20
195.0	6.80	6.39	4.83	1.79	-2.39	-10.34	-13.78	-15.76
210.0	6.17	5.62	4.24	0.93	-3.35	-10.55	-12.78	-15.67
225.0	4.80	4.00	2.99	-0.66	-4.59	-11.64	-12.24	-17.07
240.0	2.59	1.52	0.82	-3.12	-6.25	-13.50	-12.03	-18.08
255.0	-1.43	-3.40	-2.87	-7.75	-9.44	-16.15	-13.47	-16.13
270.0	-9.54	-14.10	-10.26	-16.91	-14.47	-17.99	-16.12	-13.44
285.0	-10.48	-8.14	-13.54	-12.07	-20.97	-18.49	-18.08	-11.18
300.0	-1.84	-1.54	-4.92	-6.55	-14.96	-18.92	-17.56	-9.86
315.0	2.17	2.04	-0.94	-3.63	-11.39	-20.53	-16.66	-9.87
330.0	4.33	3.89	1.17	-2.12	-9.54	-20.90	-15.13	-10.42
345.0	5.73	4.99	2.43	-1.23	-8.47	-19.01	-13.03	-10.88
360.0	6.32	5.40	3.08	-0.86	-7.94	-17.62	-11.60	-11.05

(continuation of the "RP_2400.000_hor" table from column 9 ...)

Azimuth (deg)	Elevation 120 deg (dB)	Elevation 135 deg (dB)	Elevation 150 deg (dB)	Elevation 165 deg (dB)	Elevation 180 deg (dB)
0.0	-6.89	-2.14	-5.17	-7.17	-8.79
15.0	-5.25	-3.07	-7.19	-8.06	-9.81
30.0	-5.55	-4.30	-9.00	-9.41	-11.09
45.0	-6.29	-6.13	-11.28	-11.54	-13.81
60.0	-7.01	-8.23	-14.19	-14.65	-17.10
75.0	-8.29	-11.59	-16.46	-19.78	-19.39
90.0	-10.58	-15.66	-16.36	-19.93	-17.31
105.0	-15.61	-17.24	-14.31	-15.49	-13.52
120.0	-20.28	-12.66	-12.39	-12.62	-11.19
135.0	-16.27	-9.63	-11.02	-10.40	-9.54
150.0	-13.88	-8.16	-9.67	-9.10	-8.58
165.0	-12.74	-7.28	-8.41	-8.32	-8.22
180.0	-11.72	-6.48	-7.42	-7.87	-8.45
195.0	-11.65	-6.02	-6.28	-8.11	-8.98
210.0	-12.85	-6.98	-5.71	-8.59	-10.21
225.0	-14.88	-9.07	-6.04	-9.46	-12.43
240.0	-17.77	-12.29	-7.75	-10.92	-15.55
255.0	-20.07	-16.85	-10.89	-13.96	-19.34
270.0	-17.67	-17.49	-15.45	-18.26	-18.79
285.0	-15.08	-12.11	-16.45	-17.12	-14.63
300.0	-13.65	-8.78	-10.91	-13.51	-11.81
315.0	-12.96	-5.76	-7.43	-10.32	-9.65
330.0	-11.61	-3.62	-5.64	-8.56	-8.70
345.0	-9.27	-2.31	-4.96	-7.45	-8.39
360.0	-6.82	-2.00	-5.70	-6.98	-8.84

Application Note DNO34

RP_2400.000_ver

Azimuth (deg)	Elevation 0 deg (dB)	Elevation 15 deg (dB)	Elevation 30 deg (dB)	Elevation 45 deg (dB)	Elevation 60 deg (dB)	Elevation 75 deg (dB)	Elevation 90 deg (dB)	Elevation 105 deg (dB)
0.0	-12.09	-10.53	-8.87	-12.61	-14.84	-16.86	-17.19	-16.38
15.0	-6.83	-12.85	-12.78	-16.66	-15.30	-15.04	-17.48	-16.58
30.0	-0.61	-3.00	-3.17	-6.08	-8.25	-12.34	-14.99	-15.24
45.0	2.80	1.54	1.55	-0.99	-3.63	-10.69	-12.18	-12.87
60.0	4.71	4.09	4.20	1.84	-0.90	-9.92	-8.04	-9.94
75.0	5.85	5.71	5.83	3.95	0.97	-9.00	-4.67	-5.83
90.0	6.30	6.46	6.59	4.93	1.83	-7.32	-2.78	-3.47
105.0	6.09	6.58	6.58	5.22	2.01	-6.03	-2.47	-2.20
120.0	5.35	6.14	5.87	4.77	1.46	-5.69	-3.42	-2.39
135.0	3.78	4.85	4.19	3.31	-0.16	-6.46	-6.21	-3.94
150.0	1.32	2.71	1.65	1.06	-2.46	-8.69	-9.84	-6.20
165.0	-3.35	-1.13	-3.01	-3.17	-6.33	-12.79	-15.29	-9.30
180.0	-12.19	-7.93	-10.54	-9.71	-12.21	-18.94	-19.07	-13.40
195.0	-6.23	-10.93	-8.07	-10.90	-12.04	-17.23	-14.40	-18.46
210.0	-0.37	-2.77	-1.96	-4.60	-6.08	-12.22	-10.31	-10.11
225.0	3.06	1.49	1.72	-0.74	-2.58	-8.49	-6.84	-4.95
240.0	4.99	3.79	3.76	1.41	-0.83	-6.11	-4.31	-2.02
255.0	6.08	5.23	4.98	2.77	0.04	-4.59	-3.35	-0.37
270.0	6.45	5.91	5.53	3.37	0.17	-4.07	-3.36	0.16
285.0	6.31	6.01	5.41	3.24	-0.27	-5.06	-4.40	-0.53
300.0	5.59	5.54	4.75	2.42	-1.16	-7.18	-6.24	-2.16
315.0	4.13	4.36	3.47	1.11	-2.82	-10.24	-8.83	-5.13
330.0	1.77	2.45	1.45	-0.87	-5.09	-13.07	-11.76	-8.36
345.0	-2.58	-1.04	-1.96	-4.05	-8.45	-16.13	-15.31	-13.04
360.0	-8.12	-7.11	-5.65	-9.16	-12.45	-18.36	-16.74	-16.33

(continuation of the "RP_2400.000_ver" table from column 9 ...)

Azimuth (deg)	Elevation 120 deg (dB)	Elevation 135 deg (dB)	Elevation 150 deg (dB)	Elevation 165 deg (dB)	Elevation 180 deg (dB)
0.0	-16.68	-18.66	-15.62	-18.47	-14.33
15.0	-18.43	-13.01	-13.57	-17.55	-13.45
30.0	-12.45	-9.14	-11.66	-14.57	-12.50
45.0	-7.66	-6.88	-9.41	-12.38	-11.67
60.0	-4.66	-5.07	-7.91	-11.27	-10.97
75.0	-2.55	-3.89	-6.98	-10.86	-11.02
90.0	-1.74	-3.57	-6.97	-11.13	-11.19
105.0	-2.10	-3.65	-7.32	-11.54	-12.04
120.0	-3.59	-4.61	-7.91	-12.19	-12.51
135.0	-6.83	-6.47	-9.19	-12.56	-12.79
150.0	-10.76	-9.74	-10.65	-13.22	-13.33
165.0	-16.14	-14.17	-13.83	-14.65	-14.58
180.0	-18.12	-15.54	-17.77	-16.64	-15.59
195.0	-14.93	-11.07	-16.46	-19.08	-15.70
210.0	-11.81	-8.34	-11.36	-18.63	-14.41
225.0	-8.84	-6.50	-8.33	-15.71	-13.82
240.0	-7.16	-5.56	-6.62	-12.72	-12.83
255.0	-5.74	-5.02	-5.66	-11.02	-11.72
270.0	-5.57	-4.65	-5.23	-9.32	-12.14
285.0	-6.26	-4.96	-5.41	-8.66	-11.95
300.0	-7.39	-5.37	-5.98	-8.55	-12.82
315.0	-9.13	-6.55	-7.30	-9.61	-13.52
330.0	-10.93	-8.44	-9.59	-11.17	-14.27
345.0	-12.71	-12.27	-13.81	-14.17	-14.30
360.0	-15.31	-18.17	-16.05	-18.18	-13.93

Application Note DNO34

Theta = 90, Phi = 0

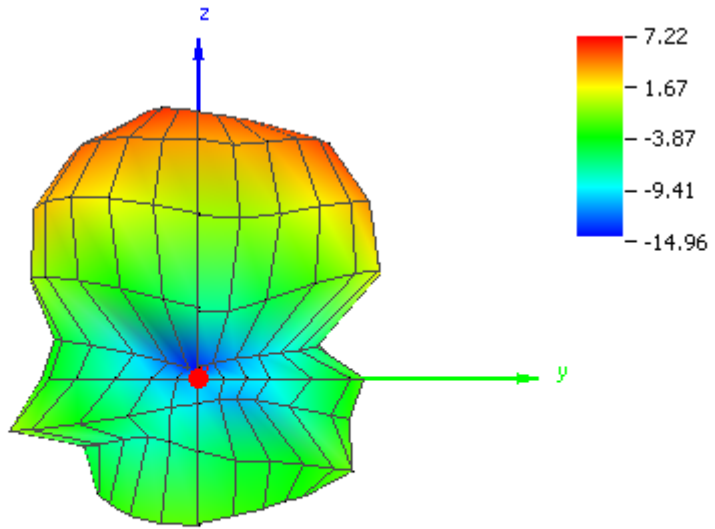

Theta = 90, Phi = 90

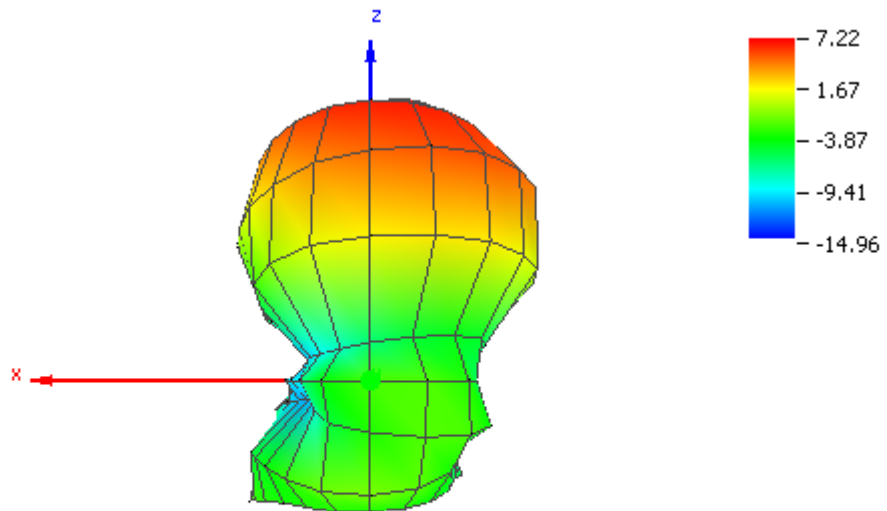

Application Note DN034

Theta = 0, Phi = 0

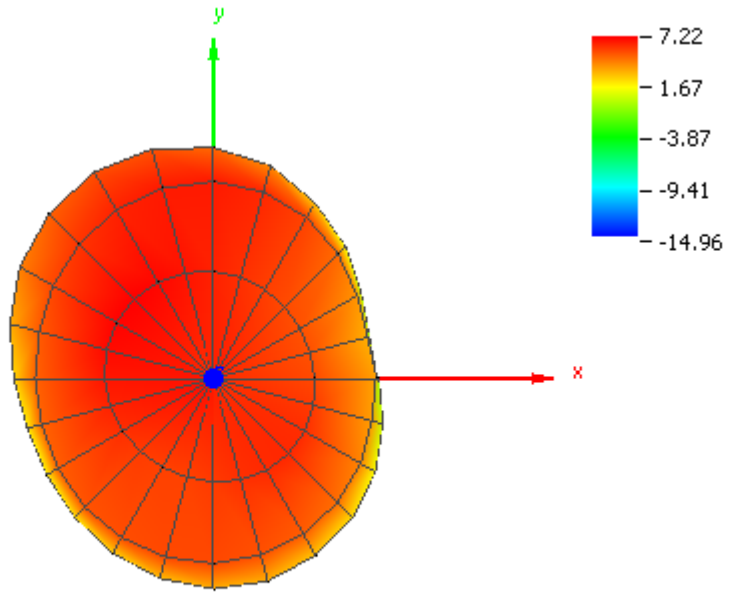

Theta = 90, Phi = 180

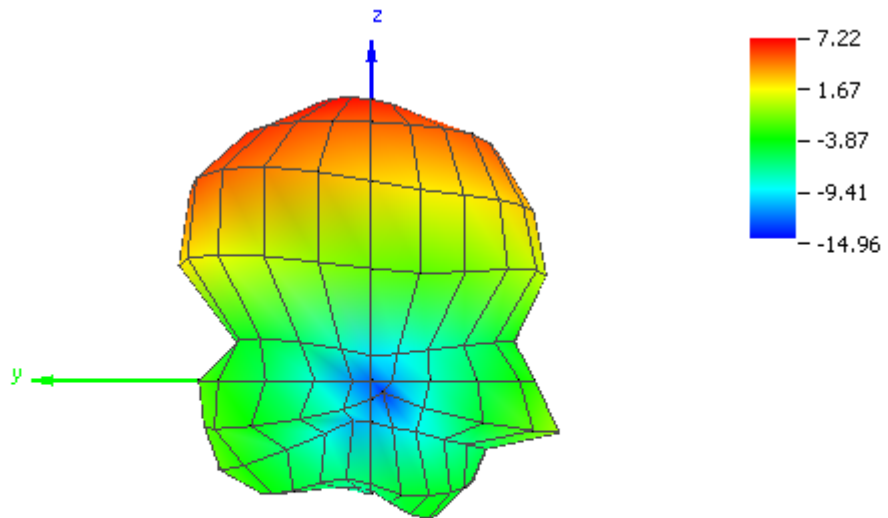

Application Note DNO34

Theta = 90, Phi = 270

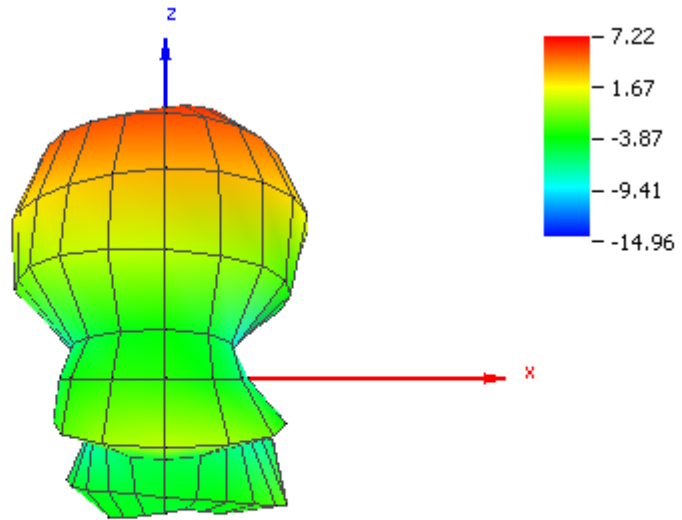

Theta = 180, Phi = 0

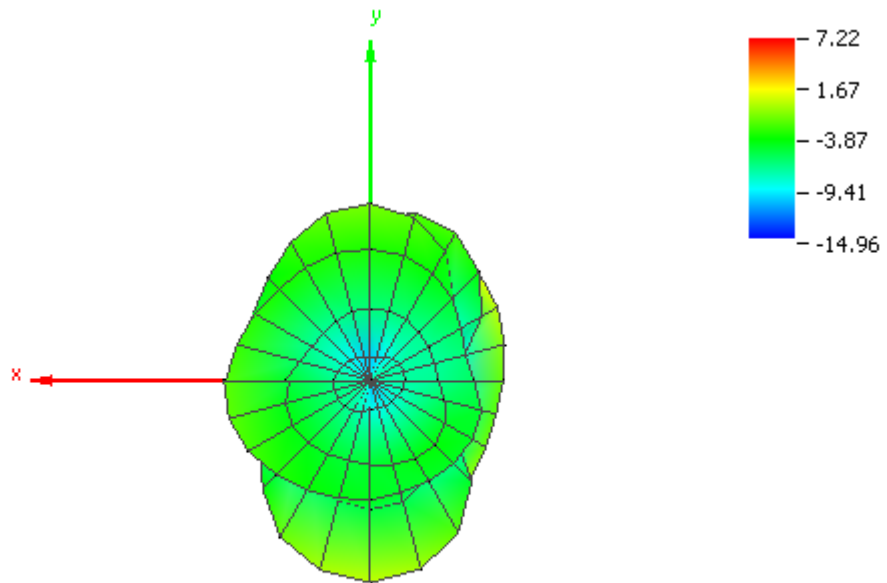

8.2 OTA Test Results for Frequency 2440.000 MHz

RP_2440.000_tot

Azimuth (deg)	Elevation 0 deg (dB)	Elevation 15 deg (dB)	Elevation 30 deg (dB)	Elevation 45 deg (dB)	Elevation 60 deg (dB)	Elevation 75 deg (dB)	Elevation 90 deg (dB)	Elevation 105 deg (dB)
0.00	6.39	5.83	3.83	-0.71	-8.58	-11.45	-11.01	-12.61
15.00	6.68	5.77	4.05	-0.76	-8.61	-11.69	-11.03	-11.96
30.00	6.98	5.81	4.54	-0.14	-6.86	-13.39	-12.53	-11.31
45.00	7.06	5.94	4.98	1.02	-5.03	-15.01	-13.12	-10.85
60.00	7.11	6.04	5.34	2.04	-3.41	-14.38	-10.81	-7.11
75.00	6.95	6.29	5.60	3.03	-2.34	-11.73	-7.52	-3.83
90.00	6.71	6.56	5.71	3.81	-1.36	-9.82	-5.22	-2.17
105.00	6.48	6.89	5.78	4.31	-0.98	-8.57	-4.64	-1.78
120.00	6.33	7.12	5.78	4.44	-1.02	-8.10	-5.25	-2.58
135.00	6.30	7.18	5.71	4.10	-1.59	-8.81	-6.84	-4.77
150.00	6.34	7.08	5.57	3.48	-2.65	-9.74	-8.57	-7.60
165.00	6.48	6.89	5.41	2.74	-3.66	-10.65	-9.81	-10.75
180.00	6.67	6.61	5.31	2.09	-4.27	-11.25	-10.37	-12.96
195.00	6.90	6.35	5.32	1.86	-3.98	-11.42	-10.07	-12.11
210.00	7.06	6.18	5.42	1.93	-3.40	-11.09	-8.65	-9.26
225.00	7.16	5.99	5.49	2.21	-2.21	-10.55	-6.32	-7.16
240.00	7.07	5.98	5.50	2.54	-1.28	-10.24	-4.17	-5.04
255.00	6.99	5.98	5.48	2.76	-0.87	-10.50	-2.88	-3.85
270.00	6.71	6.00	5.32	2.78	-1.04	-11.39	-2.71	-3.14
285.00	6.50	6.14	5.11	2.72	-1.63	-13.19	-3.47	-3.92
300.00	6.38	6.26	4.78	2.49	-2.78	-14.51	-5.17	-5.74
315.00	6.26	6.28	4.47	1.95	-4.32	-14.58	-7.46	-8.39
330.00	6.26	6.22	4.09	1.09	-5.78	-13.47	-9.22	-11.78
345.00	6.32	6.07	3.81	0.07	-7.26	-12.73	-10.43	-14.10
360.00	6.51	5.91	3.82	-0.46	-8.25	-12.10	-10.55	-14.03

(continuation of the "RP_2440.000_tot" table from column 9 ...)

Azimuth (deg)	Elevation 120 deg (dB)	Elevation 135 deg (dB)	Elevation 150 deg (dB)	Elevation 165 deg (dB)	Elevation 180 deg (dB)
0.00	-5.82	-8.97	-8.71	-6.14	-6.03
15.00	-6.02	-10.21	-8.44	-6.52	-6.03
30.00	-5.70	-10.35	-8.59	-7.78	-6.39
45.00	-4.43	-9.04	-8.85	-9.84	-6.97
60.00	-3.01	-7.85	-9.28	-12.50	-7.64
75.00	-2.02	-7.35	-9.84	-15.50	-8.84
90.00	-1.93	-7.15	-11.19	-15.89	-10.16
105.00	-2.30	-7.36	-12.32	-13.75	-10.29
120.00	-3.60	-7.60	-13.62	-11.87	-10.46
135.00	-5.78	-8.44	-13.49	-10.17	-9.30
150.00	-8.57	-9.68	-13.79	-9.40	-8.05
165.00	-10.35	-10.78	-13.79	-8.84	-7.18
180.00	-9.88	-9.61	-14.22	-8.68	-6.78
195.00	-7.89	-7.50	-16.28	-9.07	-6.68
210.00	-5.86	-5.74	-15.00	-9.76	-7.13
225.00	-4.17	-4.64	-11.93	-11.46	-8.00
240.00	-2.89	-4.47	-10.29	-13.16	-9.18
255.00	-2.07	-4.27	-9.81	-13.80	-10.62
270.00	-2.07	-4.40	-9.75	-13.45	-11.87
285.00	-2.36	-4.36	-10.58	-11.90	-12.64
300.00	-3.13	-4.40	-10.86	-10.61	-11.04
315.00	-3.90	-4.72	-11.95	-8.59	-9.23
330.00	-4.78	-5.36	-12.42	-7.31	-7.48
345.00	-5.45	-6.72	-10.69	-6.41	-6.78
360.00	-5.64	-8.02	-9.12	-6.22	-6.16

RP_2440.000_hor

Azimuth (deg)	Elevation 0 deg (dB)	Elevation 15 deg (dB)	Elevation 30 deg (dB)	Elevation 45 deg (dB)	Elevation 60 deg (dB)	Elevation 75 deg (dB)	Elevation 90 deg (dB)	Elevation 105 deg (dB)
0.0	6.34	5.79	3.77	-0.79	-9.23	-13.82	-11.87	-14.00
15.0	6.29	5.59	3.72	-1.04	-9.87	-14.64	-12.05	-12.83
30.0	5.64	4.81	3.23	-1.81	-11.07	-17.55	-13.55	-12.47
45.0	4.29	3.27	2.04	-3.13	-12.31	-18.47	-14.63	-13.44
60.0	1.88	0.35	-0.32	-5.61	-14.00	-16.04	-14.55	-12.19
75.0	-2.22	-4.97	-4.48	-10.84	-16.92	-15.34	-14.98	-11.64
90.0	-12.39	-16.58	-15.52	-17.48	-16.79	-16.39	-16.55	-11.82
105.0	-7.76	-4.18	-7.38	-7.54	-12.13	-14.91	-16.70	-13.85
120.0	-0.77	0.98	-1.00	-2.81	-8.80	-13.01	-13.81	-16.55
135.0	2.85	3.78	2.24	-0.28	-6.86	-12.06	-12.19	-17.96
150.0	4.93	5.39	4.04	1.16	-5.88	-12.33	-11.00	-17.86
165.0	6.12	6.31	4.99	1.90	-5.11	-12.98	-11.06	-17.70
180.0	6.65	6.52	5.26	1.96	-4.82	-13.08	-11.36	-17.18
195.0	6.58	6.18	5.02	1.62	-4.72	-12.87	-10.90	-15.81
210.0	5.89	5.29	4.27	0.77	-5.48	-13.05	-10.31	-14.51
225.0	4.59	3.57	2.86	-0.69	-6.66	-13.28	-10.28	-14.88
240.0	2.24	0.87	0.48	-3.11	-8.09	-14.46	-10.28	-16.05
255.0	-1.63	-4.03	-3.55	-7.77	-10.89	-16.68	-11.33	-17.93
270.0	-10.06	-15.06	-12.49	-18.00	-15.40	-18.76	-11.97	-17.90
285.0	-10.04	-6.56	-10.23	-11.19	-21.05	-19.36	-11.75	-16.02
300.0	-1.47	-0.62	-3.32	-5.79	-16.16	-17.70	-11.23	-15.46
315.0	2.35	2.60	0.15	-3.15	-12.37	-16.74	-10.93	-16.46
330.0	4.57	4.34	2.08	-1.86	-10.36	-15.31	-10.97	-17.88
345.0	5.83	5.35	3.14	-1.18	-9.30	-14.35	-11.50	-17.79
360.0	6.42	5.79	3.67	-0.68	-9.17	-14.13	-11.43	-16.23

(continuation of the "RP_2440.000_hor" table from column 9 ...)

Azimuth (deg)	Elevation 120 deg (dB)	Elevation 135 deg (dB)	Elevation 150 deg (dB)	Elevation 165 deg (dB)	Elevation 180 deg (dB)
0.0	-6.12	-9.62	-10.17	-6.55	-6.51
15.0	-6.79	-11.71	-9.49	-6.91	-6.61
30.0	-8.37	-13.89	-9.37	-8.19	-6.99
45.0	-9.35	-14.60	-9.71	-10.40	-8.06
60.0	-10.02	-14.70	-10.71	-13.63	-9.66
75.0	-11.15	-15.63	-11.95	-18.78	-12.26
90.0	-13.63	-17.55	-14.87	-20.19	-16.51
105.0	-18.32	-19.45	-17.89	-15.38	-17.56
120.0	-18.82	-18.61	-20.80	-12.70	-14.63
135.0	-14.90	-16.40	-19.19	-10.73	-11.21
150.0	-13.06	-14.60	-17.41	-9.92	-8.88
165.0	-11.90	-12.86	-16.74	-9.28	-7.62
180.0	-10.45	-10.27	-17.05	-9.11	-7.05
195.0	-10.14	-8.45	-19.47	-9.57	-6.97
210.0	-11.09	-7.75	-18.41	-10.63	-7.52
225.0	-13.51	-8.00	-15.83	-13.41	-8.54
240.0	-17.20	-10.01	-14.98	-16.77	-10.04
255.0	-19.01	-12.75	-16.20	-19.51	-12.54
270.0	-15.87	-14.77	-18.50	-16.22	-15.09
285.0	-12.75	-13.57	-20.58	-13.24	-17.23
300.0	-10.04	-10.96	-20.30	-11.22	-13.85
315.0	-8.23	-9.07	-19.86	-8.96	-10.70
330.0	-7.14	-8.13	-17.84	-7.71	-8.40
345.0	-6.50	-8.19	-13.60	-6.80	-7.50
360.0	-6.03	-8.86	-10.70	-6.62	-6.70

Application Note DNO34

RP_2440.000_ver

Azimuth (deg)	Elevation 0 deg (dB)	Elevation 15 deg (dB)	Elevation 30 deg (dB)	Elevation 45 deg (dB)	Elevation 60 deg (dB)	Elevation 75 deg (dB)	Elevation 90 deg (dB)	Elevation 105 deg (dB)
0.0	-12.92	-14.26	-14.64	-18.15	-17.19	-15.21	-18.44	-18.25
15.0	-4.01	-8.03	-7.24	-12.93	-14.62	-14.77	-17.80	-19.36
30.0	1.22	-1.06	-1.30	-5.09	-8.94	-15.49	-19.33	-17.60
45.0	3.80	2.56	1.91	-1.10	-5.93	-17.61	-18.45	-14.32
60.0	5.56	4.67	3.96	1.23	-3.81	-19.36	-13.21	-8.72
75.0	6.38	5.95	5.15	2.85	-2.50	-14.22	-8.37	-4.62
90.0	6.65	6.53	5.68	3.77	-1.49	-10.91	-5.56	-2.67
105.0	6.31	6.53	5.56	4.02	-1.32	-9.71	-4.92	-2.05
120.0	5.39	5.91	4.76	3.53	-1.82	-9.79	-5.90	-2.76
135.0	3.69	4.53	3.12	2.13	-3.13	-11.59	-8.34	-4.99
150.0	0.76	2.14	0.30	-0.35	-5.46	-13.21	-12.25	-8.03
165.0	-4.62	-2.12	-4.99	-4.77	-9.15	-14.48	-15.84	-11.73
180.0	-16.96	-10.38	-14.47	-13.19	-13.50	-15.89	-17.29	-15.02
195.0	-4.64	-7.85	-6.44	-10.87	-12.03	-16.89	-17.65	-14.51
210.0	0.79	-1.13	-0.90	-4.39	-7.59	-15.49	-13.63	-10.80
225.0	3.66	2.30	2.07	-0.91	-4.14	-13.87	-8.55	-7.97
240.0	5.34	4.38	3.86	1.17	-2.29	-12.31	-5.38	-5.40
255.0	6.34	5.52	4.90	2.36	-1.33	-11.70	-3.55	-4.03
270.0	6.62	5.97	5.25	2.74	-1.21	-12.27	-3.26	-3.29
285.0	6.40	5.90	4.98	2.54	-1.68	-14.39	-4.16	-4.20
300.0	5.60	5.26	4.05	1.80	-2.98	-17.34	-6.40	-6.23
315.0	4.00	3.86	2.47	0.34	-5.06	-18.66	-10.07	-9.13
330.0	1.33	1.67	-0.23	-1.98	-7.64	-18.09	-13.99	-13.01
345.0	-3.47	-2.09	-4.61	-5.96	-11.53	-17.81	-17.07	-16.53
360.0	-10.28	-9.90	-11.02	-13.53	-15.40	-16.39	-17.91	-18.03

(continuation of the "RP_2440.000_ver" table from column 9 ...)

Azimuth (deg)	Elevation 120 deg (dB)	Elevation 135 deg (dB)	Elevation 150 deg (dB)	Elevation 165 deg (dB)	Elevation 180 deg (dB)
0.0	-17.57	-17.58	-14.16	-16.55	-15.83
15.0	-13.90	-15.56	-15.12	-17.18	-15.06
30.0	-9.08	-12.88	-16.44	-18.26	-15.34
45.0	-6.12	-10.45	-16.30	-19.07	-13.54
60.0	-3.97	-8.85	-14.79	-18.93	-11.93
75.0	-2.59	-8.04	-13.99	-18.25	-11.47
90.0	-2.23	-7.56	-13.62	-17.92	-11.31
105.0	-2.41	-7.64	-13.73	-18.79	-11.19
120.0	-3.73	-7.96	-14.55	-19.47	-12.56
135.0	-6.35	-9.20	-14.86	-19.33	-13.80
150.0	-10.48	-11.37	-16.27	-18.86	-15.69
165.0	-15.55	-14.99	-16.85	-18.99	-17.35
180.0	-18.97	-18.14	-17.42	-18.91	-19.00
195.0	-11.83	-14.58	-19.12	-18.72	-18.65
210.0	-7.41	-10.07	-17.65	-17.18	-17.77
225.0	-4.70	-7.33	-14.21	-15.88	-17.32
240.0	-3.06	-5.89	-12.09	-15.65	-16.61
255.0	-2.15	-4.94	-10.95	-15.16	-15.10
270.0	-2.25	-4.81	-10.37	-16.72	-14.67
285.0	-2.78	-4.91	-11.04	-17.64	-14.50
300.0	-4.11	-5.48	-11.38	-19.47	-14.27
315.0	-5.90	-6.71	-12.71	-19.47	-14.64
330.0	-8.56	-8.63	-13.89	-17.80	-14.67
345.0	-12.13	-12.15	-13.80	-17.12	-14.97
360.0	-16.30	-15.58	-14.28	-16.75	-15.46

Application Note DNO34

Theta = 90, Phi = 0

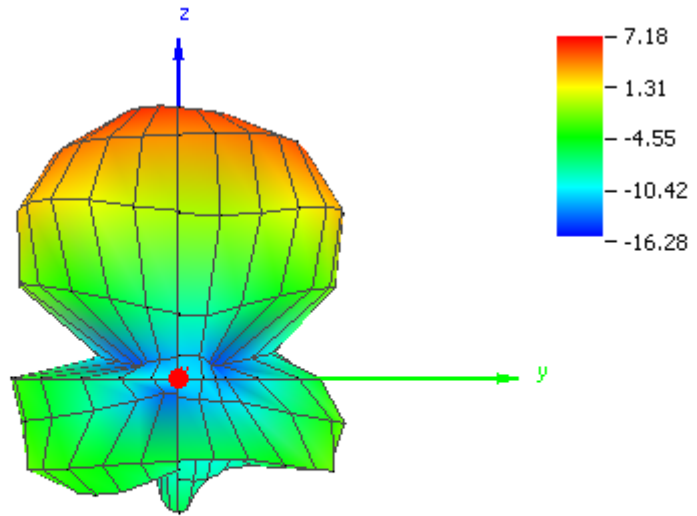

Theta = 90, Phi = 90

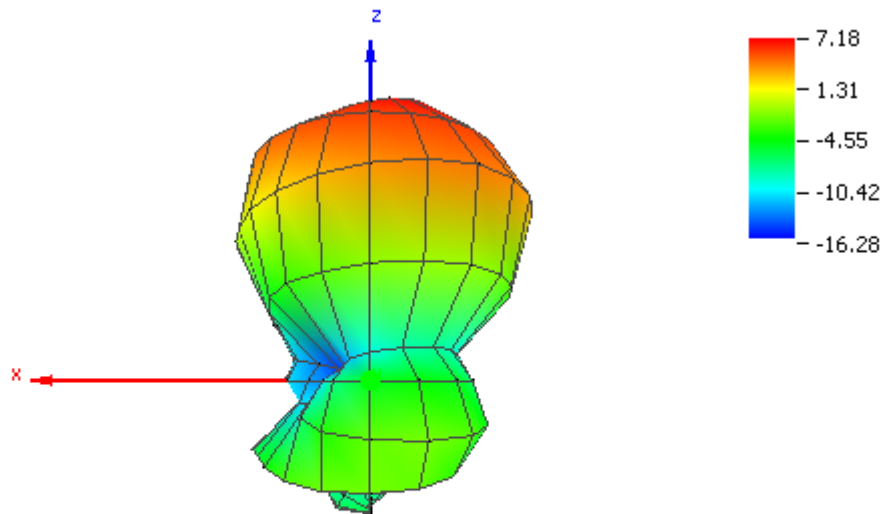

Theta = 0, Phi = 0

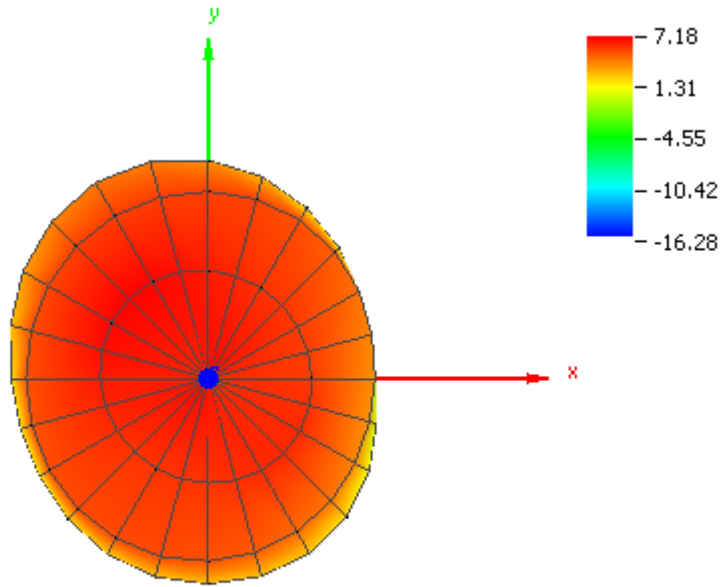

Theta = 90, Phi = 180

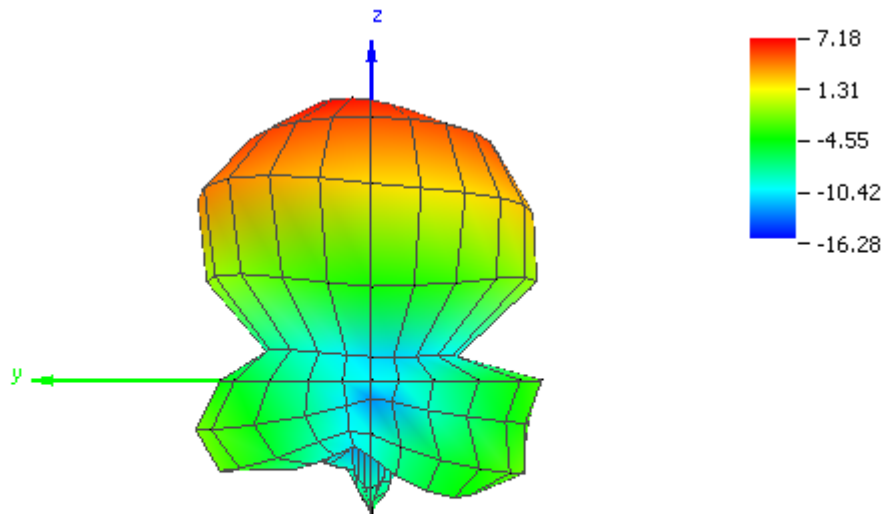

Application Note DN034

Theta = 90, Phi = 270

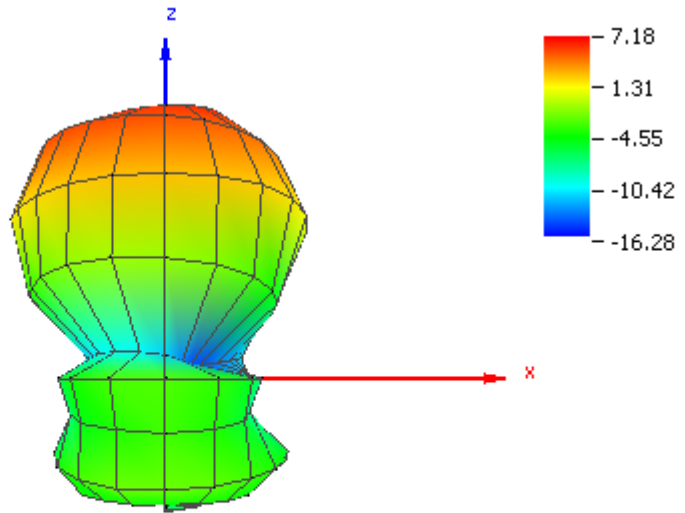

Theta = 180, Phi = 0

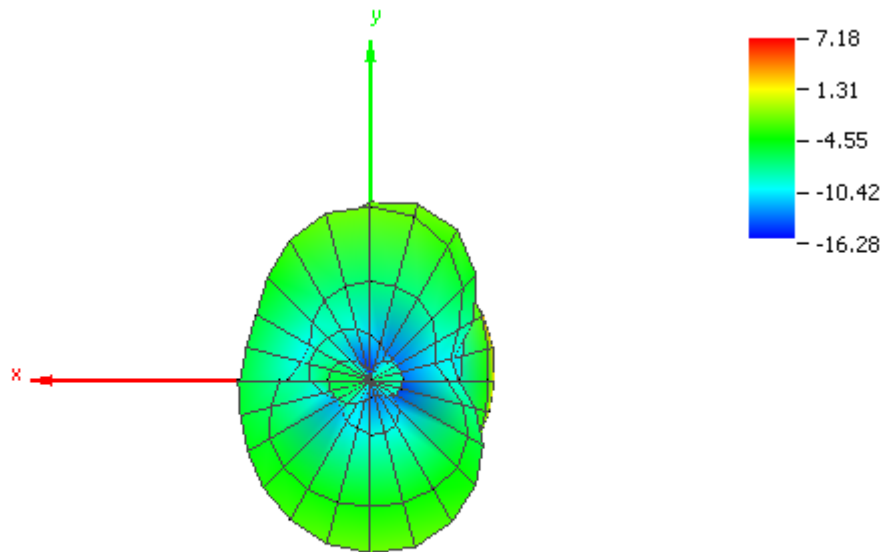

8.3 OTA Test Results for Frequency 2480.000 MHz

RP_2480.000_tot

Azimuth (deg)	Elevation 0 deg (dB)	Elevation 15 deg (dB)	Elevation 30 deg (dB)	Elevation 45 deg (dB)	Elevation 60 deg (dB)	Elevation 75 deg (dB)	Elevation 90 deg (dB)	Elevation 105 deg (dB)
0.00	6.55	5.40	2.56	-3.22	-10.28	-12.56	-15.74	-9.31
15.00	6.81	5.37	2.82	-2.94	-10.12	-13.37	-16.30	-9.22
30.00	7.02	5.44	3.28	-1.99	-8.67	-15.78	-13.80	-9.72
45.00	7.10	5.63	3.77	-0.95	-8.05	-16.81	-11.02	-8.67
60.00	7.11	5.81	4.16	-0.20	-7.76	-15.40	-7.27	-5.33
75.00	7.05	6.06	4.44	0.52	-7.55	-12.60	-4.44	-2.95
90.00	6.89	6.32	4.72	1.28	-7.18	-9.84	-2.64	-1.25
105.00	6.80	6.64	4.84	1.89	-6.34	-8.50	-2.34	-0.74
120.00	6.69	6.81	4.86	2.35	-5.38	-8.11	-3.31	-1.33
135.00	6.63	6.82	4.74	2.10	-5.17	-8.81	-5.64	-3.03
150.00	6.52	6.59	4.44	1.50	-5.31	-9.12	-8.97	-5.51
165.00	6.43	6.21	4.15	0.65	-6.05	-9.04	-12.73	-8.52
180.00	6.41	5.82	3.92	-0.29	-7.04	-8.75	-13.03	-12.69
195.00	6.57	5.62	3.94	-0.82	-7.52	-8.93	-10.29	-12.93
210.00	6.82	5.64	4.29	-0.40	-7.20	-9.42	-7.21	-7.83
225.00	7.01	5.81	4.68	0.47	-6.18	-9.80	-5.12	-4.47
240.00	7.13	6.12	4.96	1.41	-5.02	-9.52	-3.12	-2.40
255.00	7.08	6.31	5.08	2.12	-4.21	-9.20	-2.15	-1.36
270.00	6.88	6.50	4.99	2.42	-3.86	-8.77	-2.14	-1.06
285.00	6.68	6.52	4.70	2.17	-4.23	-8.72	-3.37	-1.65
300.00	6.48	6.50	4.28	1.53	-5.44	-9.76	-5.70	-2.90
315.00	6.34	6.33	3.70	0.58	-6.91	-11.68	-8.65	-4.49
330.00	6.32	6.05	3.00	-0.86	-7.99	-12.83	-11.44	-6.51
345.00	6.45	5.69	2.61	-2.24	-9.29	-12.44	-13.49	-8.08
360.00	6.64	5.57	2.60	-2.20	-9.86	-12.25	-14.87	-9.90

(continuation of the "RP_2480.000_tot" table from column 9 ...)

Azimuth (deg)	Elevation 120 deg (dB)	Elevation 135 deg (dB)	Elevation 150 deg (dB)	Elevation 165 deg (dB)	Elevation 180 deg (dB)
0.00	-9.79	-8.33	-5.96	-6.56	-8.38
15.00	-10.34	-8.70	-6.21	-6.94	-8.36
30.00	-10.67	-9.08	-6.92	-7.80	-8.73
45.00	-9.54	-9.01	-7.95	-8.79	-8.62
60.00	-8.20	-8.95	-9.08	-9.81	-8.12
75.00	-7.10	-8.80	-10.05	-10.21	-7.68
90.00	-6.37	-9.00	-10.89	-10.18	-7.33
105.00	-6.40	-9.55	-11.64	-9.92	-7.00
120.00	-7.72	-10.44	-11.12	-9.71	-7.11
135.00	-9.73	-12.80	-11.09	-9.27	-6.96
150.00	-11.94	-13.89	-10.49	-8.77	-7.00
165.00	-12.77	-13.27	-10.23	-8.47	-7.16
180.00	-11.37	-13.41	-8.50	-8.61	-7.45
195.00	-9.30	-14.34	-7.45	-8.30	-7.84
210.00	-6.92	-15.00	-6.83	-7.85	-8.18
225.00	-5.27	-14.21	-6.69	-7.71	-8.36
240.00	-3.65	-14.06	-6.72	-7.92	-8.76
255.00	-2.71	-13.53	-7.43	-8.05	-8.71
270.00	-2.67	-13.71	-8.11	-8.22	-8.66
285.00	-3.18	-14.20	-9.15	-7.70	-8.22
300.00	-4.16	-14.06	-9.38	-7.39	-7.90
315.00	-5.54	-13.46	-8.25	-6.65	-7.62
330.00	-7.21	-11.08	-6.87	-6.19	-7.70
345.00	-8.53	-9.44	-6.14	-6.18	-7.90
360.00	-9.30	-9.03	-5.96	-5.89	-8.08

Application Note DNO34

RP_2480.000_hor

Azimuth (deg)	Elevation 0 deg (dB)	Elevation 15 deg (dB)	Elevation 30 deg (dB)	Elevation 45 deg (dB)	Elevation 60 deg (dB)	Elevation 75 deg (dB)	Elevation 90 deg (dB)	Elevation 105 deg (dB)
0.0	6.53	5.38	2.53	-3.41	-11.06	-16.81	-20.36	-10.90
15.0	6.43	5.12	2.42	-3.47	-11.08	-18.35	-20.61	-9.91
30.0	5.69	4.15	1.78	-3.85	-10.93	-20.07	-20.29	-11.02
45.0	4.28	2.64	0.65	-4.53	-11.00	-21.34	-19.74	-12.38
60.0	1.76	-0.42	-1.67	-6.43	-12.21	-18.95	-17.62	-12.15
75.0	-2.39	-5.67	-5.63	-10.13	-14.39	-18.32	-16.31	-12.24
90.0	-13.03	-18.94	-15.91	-19.08	-19.14	-16.11	-15.51	-13.05
105.0	-8.28	-5.14	-9.54	-11.05	-15.98	-13.23	-14.69	-14.20
120.0	-0.74	0.16	-2.82	-5.22	-11.01	-10.98	-13.55	-17.20
135.0	2.70	2.96	0.43	-2.79	-8.86	-10.08	-12.89	-18.13
150.0	4.80	4.65	2.38	-1.48	-7.84	-10.14	-12.96	-17.67
165.0	5.88	5.48	3.40	-0.92	-7.53	-10.05	-14.73	-17.53
180.0	6.39	5.73	3.83	-0.73	-8.01	-10.10	-15.22	-16.51
195.0	6.31	5.44	3.67	-1.02	-8.52	-10.09	-15.00	-17.57
210.0	5.62	4.49	3.00	-1.84	-9.17	-10.96	-13.38	-19.15
225.0	4.29	2.89	1.74	-3.16	-10.17	-12.04	-13.11	-18.60
240.0	1.85	0.00	-0.61	-5.49	-12.14	-13.13	-13.67	-17.19
255.0	-2.18	-4.89	-4.52	-9.28	-14.67	-14.65	-15.49	-16.52
270.0	-11.65	-18.76	-13.33	-18.23	-17.71	-16.98	-16.35	-16.32
285.0	-9.39	-6.40	-12.04	-14.48	-21.11	-16.81	-15.02	-16.43
300.0	-1.13	-0.63	-4.39	-8.77	-20.22	-16.47	-14.28	-16.14
315.0	2.49	2.33	-1.04	-5.94	-16.15	-16.02	-14.70	-15.30
330.0	4.80	4.17	0.92	-4.45	-13.30	-15.93	-16.51	-13.98
345.0	6.04	5.01	1.98	-3.77	-11.98	-15.84	-18.45	-12.71
360.0	6.60	5.50	2.50	-2.48	-11.16	-16.66	-20.48	-12.37

(continuation of the "RP_2480.000_hor" table from column 9 ...)

Azimuth (deg)	Elevation 120 deg (dB)	Elevation 135 deg (dB)	Elevation 150 deg (dB)	Elevation 165 deg (dB)	Elevation 180 deg (dB)
0.0	-10.72	-8.78	-6.52	-6.82	-9.20
15.0	-11.50	-9.27	-6.85	-7.29	-9.09
30.0	-13.71	-10.04	-7.96	-8.58	-9.86
45.0	-14.18	-10.65	-9.34	-10.69	-10.97
60.0	-13.95	-11.28	-11.37	-13.88	-12.72
75.0	-13.86	-12.79	-13.62	-19.17	-15.61
90.0	-15.22	-15.29	-16.26	-19.82	-18.47
105.0	-16.80	-17.71	-17.62	-15.06	-18.84
120.0	-17.77	-17.33	-15.24	-12.42	-15.16
135.0	-17.09	-16.59	-14.10	-10.73	-11.76
150.0	-16.02	-15.83	-11.85	-9.81	-10.03
165.0	-14.61	-14.77	-10.85	-9.19	-8.64
180.0	-12.20	-15.65	-9.14	-9.10	-8.16
195.0	-10.32	-18.67	-8.83	-8.80	-8.22
210.0	-9.48	-21.10	-9.35	-8.81	-8.99
225.0	-10.20	-17.92	-11.13	-9.65	-10.20
240.0	-11.90	-16.42	-13.67	-11.42	-12.61
255.0	-14.34	-15.96	-16.53	-14.20	-15.64
270.0	-17.99	-16.06	-18.60	-18.03	-19.85
285.0	-15.83	-17.03	-17.18	-17.46	-18.08
300.0	-12.94	-16.42	-13.46	-12.87	-14.54
315.0	-11.55	-15.28	-10.42	-9.64	-12.00
330.0	-10.87	-12.39	-7.92	-7.81	-10.42
345.0	-10.43	-10.24	-6.76	-6.93	-9.51
360.0	-10.43	-9.55	-6.43	-6.21	-9.17

Application Note DNO34

RP_2480.000_ver

Azimuth (deg)	Elevation 0 deg (dB)	Elevation 15 deg (dB)	Elevation 30 deg (dB)	Elevation 45 deg (dB)	Elevation 60 deg (dB)	Elevation 75 deg (dB)	Elevation 90 deg (dB)	Elevation 105 deg (dB)
0.0	-17.73	-17.86	-18.74	-16.76	-18.13	-14.60	-17.58	-14.46
15.0	-3.94	-7.09	-7.72	-12.39	-17.13	-15.03	-18.31	-17.52
30.0	1.23	-0.48	-2.07	-6.57	-12.58	-17.81	-14.90	-15.59
45.0	3.89	2.60	0.86	-3.45	-11.12	-18.70	-11.65	-11.08
60.0	5.61	4.63	2.84	-1.38	-9.68	-17.92	-7.69	-6.34
75.0	6.52	5.75	3.99	0.13	-8.56	-13.96	-4.74	-3.49
90.0	6.85	6.30	4.68	1.24	-7.46	-11.01	-2.87	-1.54
105.0	6.67	6.34	4.68	1.67	-6.84	-10.28	-2.60	-0.94
120.0	5.83	5.75	4.04	1.51	-6.77	-11.27	-3.74	-1.45
135.0	4.37	4.52	2.73	0.39	-7.59	-14.77	-6.54	-3.17
150.0	1.67	2.15	0.22	-1.55	-8.86	-15.94	-11.18	-5.78
165.0	-2.83	-1.89	-3.89	-4.55	-11.44	-15.87	-17.05	-9.10
180.0	-15.73	-11.27	-13.35	-10.46	-14.01	-14.48	-17.03	-15.01
195.0	-5.93	-8.19	-8.26	-14.28	-14.37	-15.21	-12.07	-14.77
210.0	0.67	-0.67	-1.61	-5.87	-11.59	-14.67	-8.41	-8.16
225.0	3.69	2.70	1.59	-1.99	-8.40	-13.75	-5.87	-4.64
240.0	5.61	4.90	3.55	0.42	-5.95	-11.99	-3.52	-2.54
255.0	6.53	5.96	4.57	1.79	-4.62	-10.65	-2.36	-1.50
270.0	6.82	6.49	4.93	2.39	-4.04	-9.48	-2.31	-1.19
285.0	6.57	6.30	4.61	2.08	-4.32	-9.45	-3.68	-1.80
300.0	5.65	5.57	3.65	1.11	-5.58	-10.81	-6.35	-3.11
315.0	4.03	4.12	1.92	-0.52	-7.46	-13.67	-9.88	-4.87
330.0	1.03	1.50	-1.20	-3.35	-9.51	-15.76	-13.05	-7.36
345.0	-4.06	-2.69	-6.07	-7.53	-12.66	-15.09	-15.16	-9.91
360.0	-13.84	-13.01	-13.56	-14.36	-15.71	-14.20	-16.26	-13.54

(continuation of the "RP_2480.000_ver" table from column 9 ...)

Azimuth (deg)	Elevation 120 deg (dB)	Elevation 135 deg (dB)	Elevation 150 deg (dB)	Elevation 165 deg (dB)	Elevation 180 deg (dB)
0.0	-16.91	-18.39	-15.17	-18.87	-16.06
15.0	-16.63	-17.78	-14.85	-18.14	-16.47
30.0	-13.66	-16.07	-13.65	-15.65	-15.13
45.0	-11.37	-14.04	-13.55	-13.30	-12.41
60.0	-9.55	-12.76	-12.96	-11.97	-9.97
75.0	-8.12	-11.00	-12.56	-10.80	-8.44
90.0	-6.98	-10.16	-12.38	-10.68	-7.68
105.0	-6.82	-10.27	-12.91	-11.51	-7.29
120.0	-8.17	-11.44	-13.24	-13.04	-7.84
135.0	-10.61	-15.15	-14.11	-14.71	-8.70
150.0	-14.09	-18.32	-16.20	-15.47	-9.99
165.0	-17.41	-18.62	-18.98	-16.61	-12.56
180.0	-18.98	-17.36	-17.12	-18.31	-15.67
195.0	-16.10	-16.34	-13.11	-18.01	-18.61
210.0	-10.43	-16.22	-10.39	-14.92	-15.88
225.0	-6.95	-16.61	-8.62	-12.15	-12.97
240.0	-4.35	-17.83	-7.69	-10.49	-11.06
255.0	-3.02	-17.21	-8.00	-9.26	-9.69
270.0	-2.80	-17.50	-8.52	-8.70	-9.01
285.0	-3.43	-17.39	-9.90	-8.19	-8.70
300.0	-4.77	-17.83	-11.54	-8.83	-8.97
315.0	-6.80	-18.12	-12.31	-9.68	-9.59
330.0	-9.66	-16.90	-13.57	-11.25	-11.01
345.0	-13.03	-17.22	-14.96	-14.16	-12.97
360.0	-15.69	-18.51	-15.81	-17.38	-14.62

Application Note DNO34

Theta = 90, Phi = 0

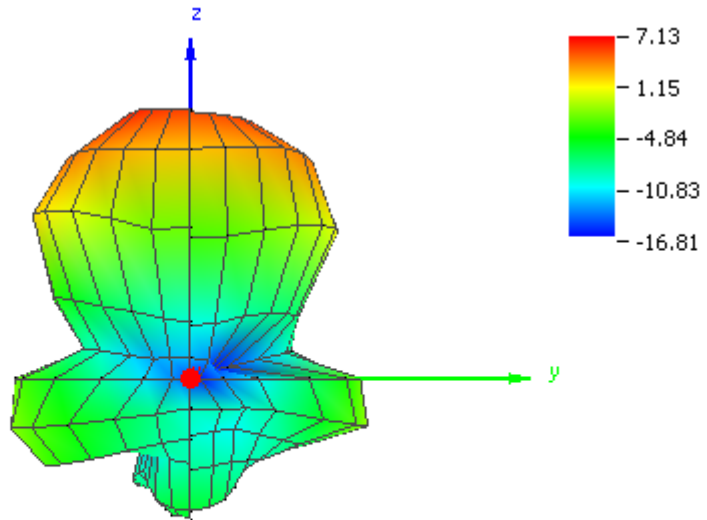

Theta = 90, Phi = 90

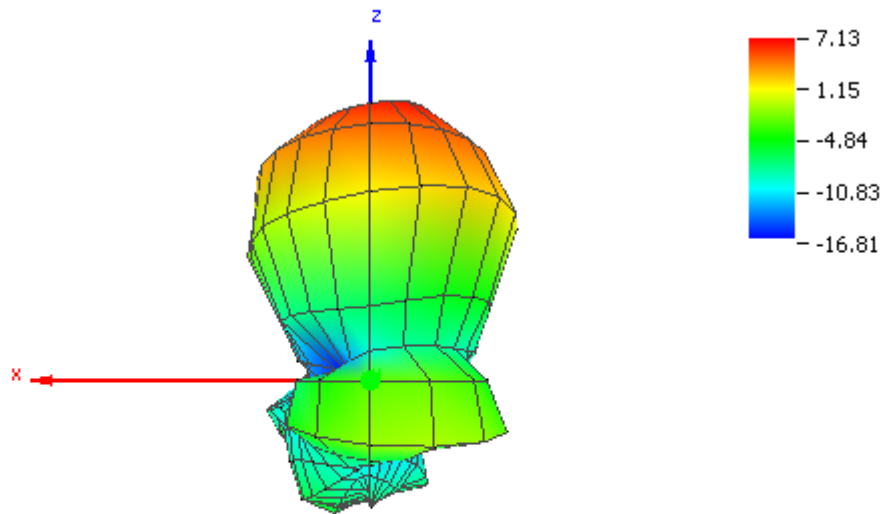

Theta = 0, Phi = 0

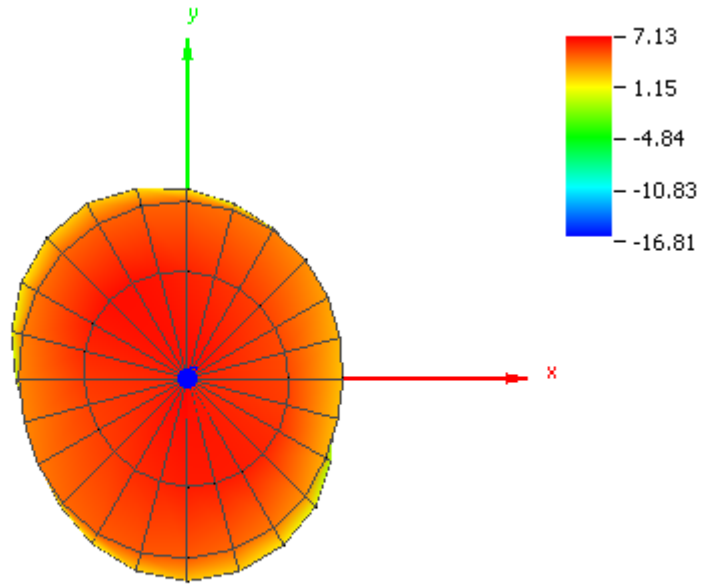

Theta = 90, Phi = 180

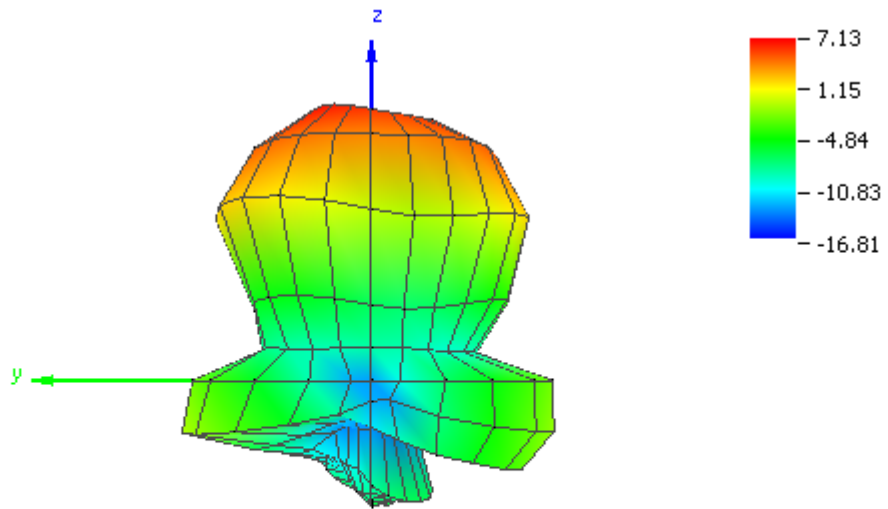

Theta = 90, Phi = 270

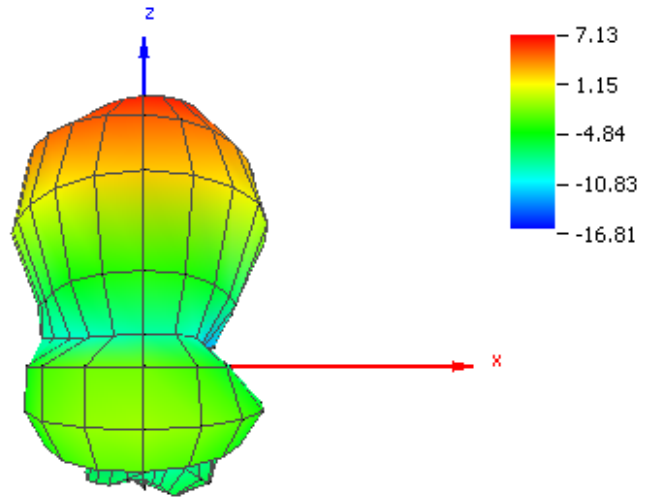

Theta = 180, Phi = 0

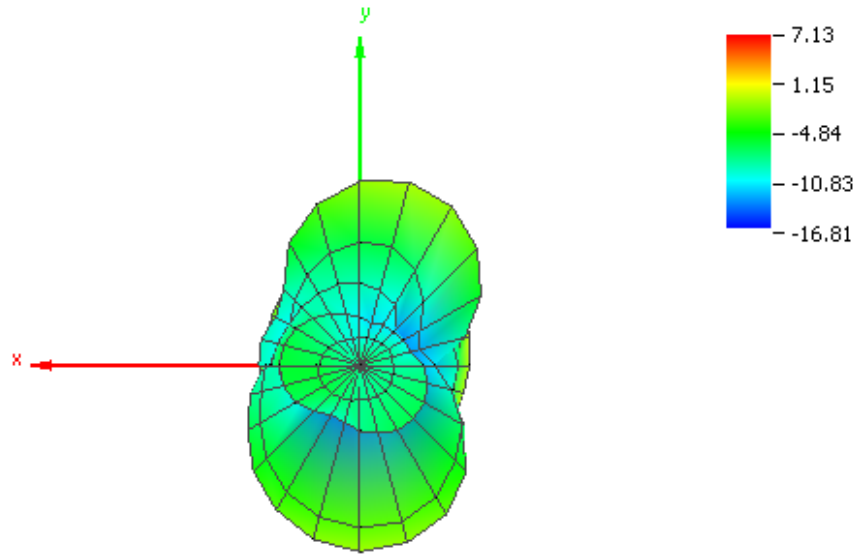

IMPORTANT NOTICE

Texas Instruments Incorporated and its subsidiaries (TI) reserve the right to make corrections, modifications, enhancements, improvements, and other changes to its products and services at any time and to discontinue any product or service without notice. Customers should obtain the latest relevant information before placing orders and should verify that such information is current and complete. All products are sold subject to TI's terms and conditions of sale supplied at the time of order acknowledgment.

TI warrants performance of its hardware products to the specifications applicable at the time of sale in accordance with TI's standard warranty. Testing and other quality control techniques are used to the extent TI deems necessary to support this warranty. Except where mandated by government requirements, testing of all parameters of each product is not necessarily performed.

TI assumes no liability for applications assistance or customer product design. Customers are responsible for their products and applications using TI components. To minimize the risks associated with customer products and applications, customers should provide adequate design and operating safeguards.

TI does not warrant or represent that any license, either express or implied, is granted under any TI patent right, copyright, mask work right, or other TI intellectual property right relating to any combination, machine, or process in which TI products or services are used. Information published by TI regarding third-party products or services does not constitute a license from TI to use such products or services or a warranty or endorsement thereof. Use of such information may require a license from a third party under the patents or other intellectual property of the third party, or a license from TI under the patents or other intellectual property of TI.

Reproduction of TI information in TI data books or data sheets is permissible only if reproduction is without alteration and is accompanied by all associated warranties, conditions, limitations, and notices. Reproduction of this information with alteration is an unfair and deceptive business practice. TI is not responsible or liable for such altered documentation. Information of third parties may be subject to additional restrictions.

Resale of TI products or services with statements different from or beyond the parameters stated by TI for that product or service voids all express and any implied warranties for the associated TI product or service and is an unfair and deceptive business practice. TI is not responsible or liable for any such statements.

TI products are not authorized for use in safety-critical applications (such as life support) where a failure of the TI product would reasonably be expected to cause severe personal injury or death, unless officers of the parties have executed an agreement specifically governing such use. Buyers represent that they have all necessary expertise in the safety and regulatory ramifications of their applications, and acknowledge and agree that they are solely responsible for all legal, regulatory and safety-related requirements concerning their products and any use of TI products in such safety-critical applications, notwithstanding any applications-related information or support that may be provided by TI. Further, Buyers must fully indemnify TI and its representatives against any damages arising out of the use of TI products in such safety-critical applications.

TI products are neither designed nor intended for use in military/aerospace applications or environments unless the TI products are specifically designated by TI as military-grade or "enhanced plastic." Only products designated by TI as military-grade meet military specifications. Buyers acknowledge and agree that any such use of TI products which TI has not designated as military-grade is solely at the Buyer's risk, and that they are solely responsible for compliance with all legal and regulatory requirements in connection with such use.

TI products are neither designed nor intended for use in automotive applications or environments unless the specific TI products are designated by TI as compliant with ISO/TS 16949 requirements. Buyers acknowledge and agree that, if they use any non-designated products in automotive applications, TI will not be responsible for any failure to meet such requirements.

Following are URLs where you can obtain information on other Texas Instruments products and application solutions:

Products		Applications	
Amplifiers	amplifier.ti.com	Audio	www.ti.com/audio
Data Converters	dataconverter.ti.com	Automotive	www.ti.com/automotive
DLP® Products	www.dlp.com	Communications and Telecom	www.ti.com/communications
DSP	dsp.ti.com	Computers and Peripherals	www.ti.com/computers
Clocks and Timers	www.ti.com/clocks	Consumer Electronics	www.ti.com/consumer-apps
Interface	interface.ti.com	Energy	www.ti.com/energy
Logic	logic.ti.com	Industrial	www.ti.com/industrial
Power Mgmt	power.ti.com	Medical	www.ti.com/medical
Microcontrollers	microcontroller.ti.com	Security	www.ti.com/security
RFID	www.ti-rfid.com	Space, Avionics & Defense	www.ti.com/space-avionics-defense
RF/IF and ZigBee® Solutions	www.ti.com/lprf	Video and Imaging	www.ti.com/video
		Wireless	www.ti.com/wireless-apps

Mailing Address: Texas Instruments, Post Office Box 655303, Dallas, Texas 75265
Copyright © 2010, Texas Instruments Incorporated