

ALL ARTWORK VIEWED FROM TOP SIDE	BOARD #: PROC113	REV: D	SUN REV: Not In VersionControl
LAYER NAME = <sup>RE Board Outline</sup> Top Overlay	TID #: N/A		
PLOT NAME = Top Overlay	GENERATED : 1/19/2023	11:56:40 AM	TEXAS INSTRUMENTS

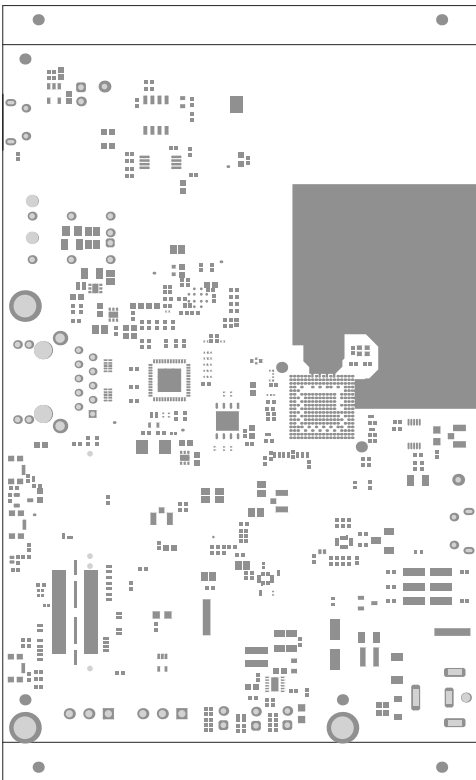

ALL ARTWORK VIEWED FROM TOP SIDE	BOARD #: PROC113	REV: D	SUN REV: Not In VersionControl
LAYER NAME = <small>PC Board Outline</small> Top Solder	TID #: N/A		
PLOT NAME = Top Solder Mask	GENERATED : 1/19/2023 11:56:43 AM	TEXAS INSTRUMENTS	

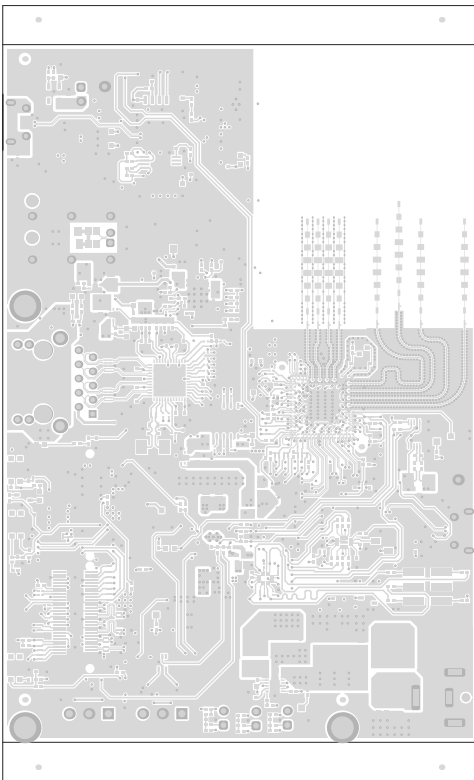

ALL ARTWORK VIEWED FROM TOP SIDE	BOARD #: PROC113	REV: D	SUN REV: Not In VersionControl
LAYER NAME = <small>≡ Board Outline</small> Top Layer	TID #: N/A		
PLOT NAME = Top Layer	GENERATED : 1/19/2023 11:56:46 AM	TEXAS INSTRUMENTS	

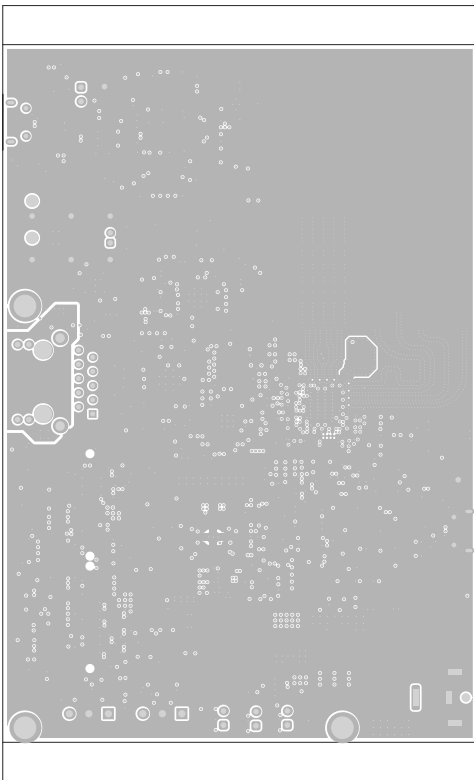

ALL ARTWORK VIEWED FROM TOP SIDE	BOARD #: PROC113	REV: D	SUN REV: Not In VersionControl
LAYER NAME = <small>Fit Board Outline</small> GND1	TID #: N/A		
PLOT NAME = Ground Layer 1	GENERATED : 1/19/2023 11:56:49 AM	TEXAS INSTRUMENTS	

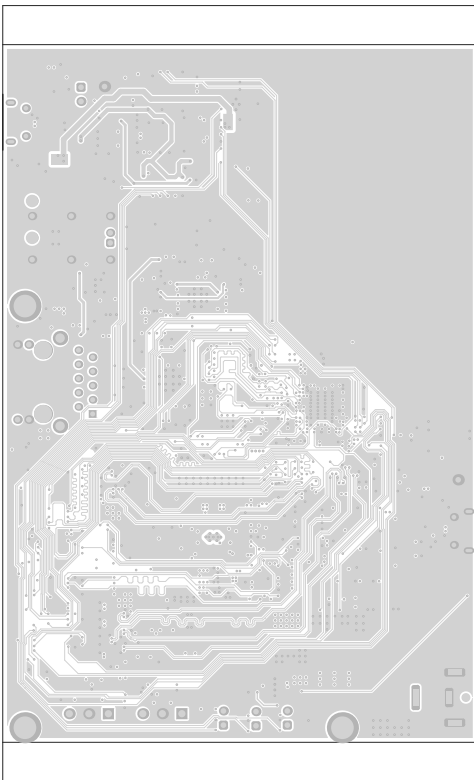

ALL ARTWORK VIEWED FROM TOP SIDE	BOARD #: PROC113	REV: D	SUN REV: Not In VersionControl
LAYER NAME = <small>≡ Board Outline</small> SIG1	TID #: N/A		
PLOT NAME = Signal Layer 1	GENERATED : 1/19/2023 11:56:53 AM	TEXAS INSTRUMENTS	

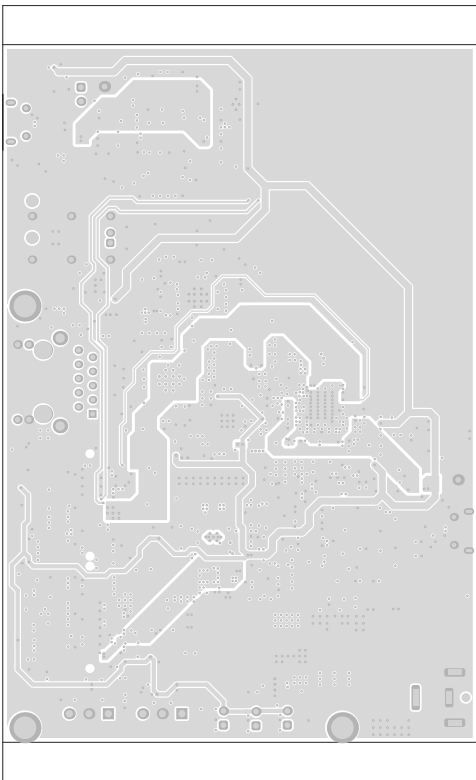

ALL ARTWORK VIEWED FROM TOP SIDE	BOARD #: PROC113	REV: D	SUN REV: Not In VersionControl
LAYER NAME = <small>PC Board Outline</small> PWR1	TID #: N/A		
PLOT NAME = Power Layer 1	GENERATED : 1/19/2023 11:56:56 AM	TEXAS INSTRUMENTS	

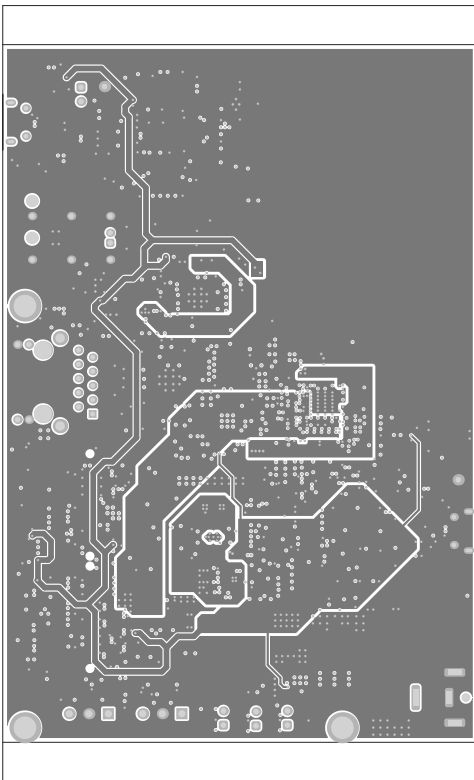

ALL ARTWORK VIEWED FROM TOP SIDE	BOARD #: PROC113	REV: D	SUN REV: Not In VersionControl
LAYER NAME = <small>PC Board Outline</small> PWR2	TID #: N/A		
PLOT NAME = Power Layer 2	GENERATED : 1/19/2023 11:56:59 AM	TEXAS INSTRUMENTS	

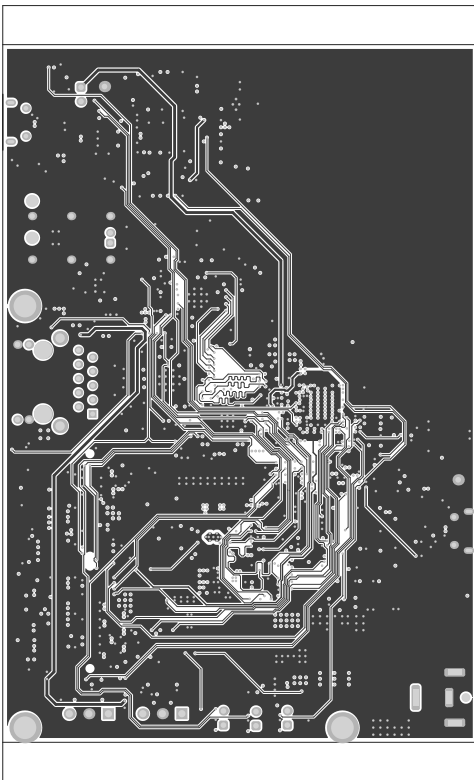

ALL ARTWORK VIEWED FROM TOP SIDE	BOARD #: PROC113	REV: D	SUN REV: Not In VersionControl
LAYER NAME = <small>≡ Board Outline</small> SIG2	TID #: N/A		
PLOT NAME = Signal Layer 2	GENERATED : 1/19/2023 11:57:02 AM	TEXAS INSTRUMENTS	



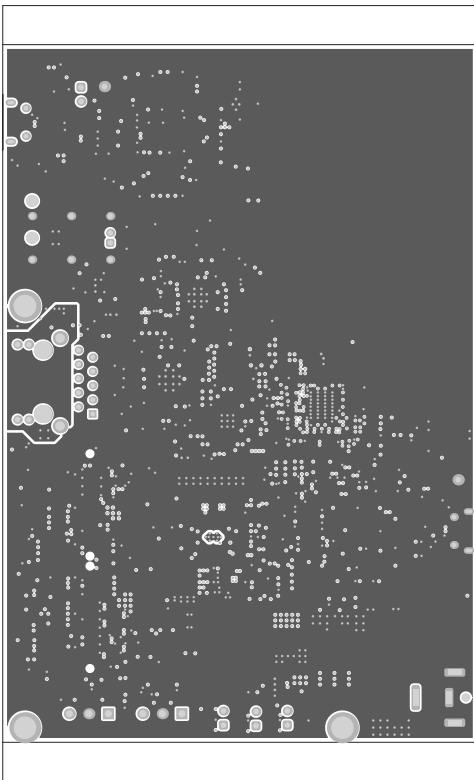

ALL ARTWORK VIEWED FROM TOP SIDE	BOARD #: PROC113	REV: D	SUN REV: Not In VersionControl
LAYER NAME = <small>PC Board Outline</small> GND4	TID #: N/A		
PLOT NAME = Ground Layer 2	GENERATED : 1/19/2023 11:57:06 AM	TEXAS INSTRUMENTS	

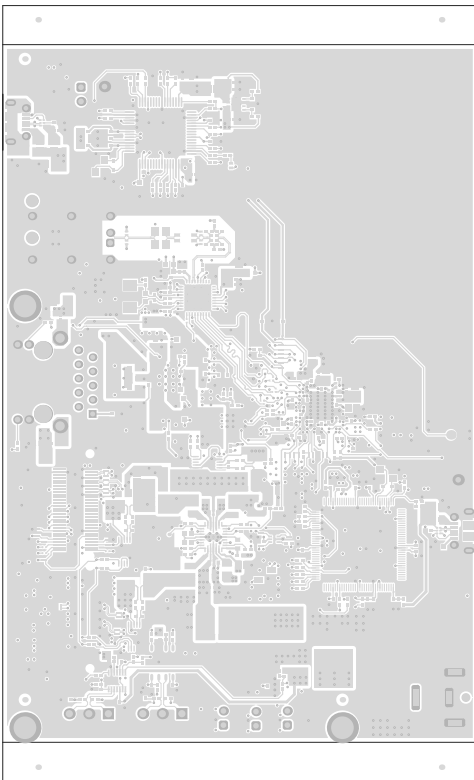

ALL ARTWORK VIEWED FROM TOP SIDE	BOARD #: PROC113	REV: D	SUN REV: Not In VersionControl
LAYER NAME = <small>PC Board Outline</small> Bottom Layer	TID #: N/A		
PLOT NAME = Bottom Layer	GENERATED : 1/19/2023 11:57:09 AM	TEXAS INSTRUMENTS	

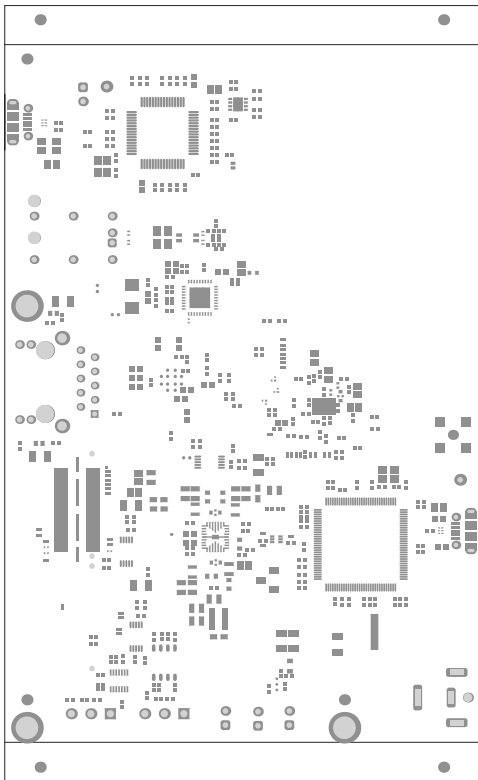

ALL ARTWORK VIEWED FROM TOP SIDE	BOARD #: PROC113	REV: D	SUN REV: Not In VersionControl
LAYER NAME = <small>PC Board Outline</small> Bottom Solder	TID #: N/A		
PLOT NAME = Bottom Solder Mask	GENERATED : 1/19/2023 11:57:13 AM	TEXAS INSTRUMENTS	



Symbol	Count	Hole Size	Plated	Hole Type	Hole Tolerance (+)	Hole Tolerance (-)	Drill Layer Pair	Routed Path Length
⌘	3	160.00mil (4.064mm)	PTH	Round			Top Layer - Bottom Layer	-
▣	2	127.95mil (3.250mm)	NPTH	Round			Top Layer - Bottom Layer	-
E	2	88.58mil (2.250mm)	NPTH	Round			Top Layer - Bottom Layer	-
⊘	2	66.93mil (1.700mm)	PTH	Round			Top Layer - Bottom Layer	-
∇	1	62.99mil (1.600mm)	NPTH	Round	3.94mil (0.100mm)	0.00mil (0.000mm)	Top Layer - Bottom Layer	-
B	6	51.18mil (1.300mm)	PTH	Round			Top Layer - Bottom Layer	-
∇	4	40.16mil (1.020mm)	NPTH	Round			Top Layer - Bottom Layer	-
◇	4	40.16mil (1.020mm)	PTH	Round			Top Layer - Bottom Layer	-
□	10	40.00mil (1.016mm)	PTH	Round			Top Layer - Bottom Layer	-
D	8	39.37mil (1.000mm)	PTH	Round	1.97mil (0.050mm)	1.97mil (0.050mm)	Top Layer - Bottom Layer	-
⊙	10	35.43mil (0.900mm)	PTH	Round			Top Layer - Bottom Layer	-
⌘	4	33.47mil (0.850mm)	PTH	Round			Top Layer - Bottom Layer	-
○	23	10.00mil (0.254mm)	PTH	Round	3.00mil (0.076mm)	3.00mil (0.076mm)	Top Layer - Bottom Layer	-
A	1055	8.00mil (0.203mm)	PTH	Round	3.00mil (0.076mm)	3.00mil (0.076mm)	Top Layer - Bottom Layer	-
★	39	7.87mil (0.200mm)	PTH	Round			Top Layer - Bottom Layer	-
☆	4	23.62mil (0.600mm)	PTH	Slot			Top Layer - Bottom Layer	27.56mil (0.700mm)
⊙	4	39.37mil (1.000mm)	PTH	Rectangle			Top Layer - Bottom Layer	(Mixed)
	1181 Total							

Slot definitions : Routed Path Length = Calculated from tool start centre position to tool end centre position.  
Hole Length = Routed Path Length + Tool Size = Slot length as defined in the PCB layout

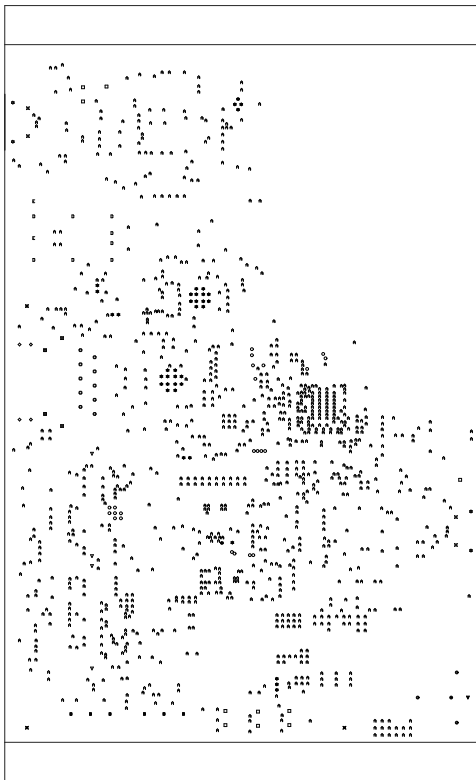

ALL ARTWORK VIEWED FROM TOP SIDE	BOARD #: PROC113	REV: D	SUN REV: Not In VersionControl
LAYER NAME = <sup>PC Board Outline</sup> Drill Drawing	TID #: N/A		
PLOT NAME = Drill Drawing	GENERATED : 1/19/2023	11:57:19 AM	TEXAS INSTRUMENTS

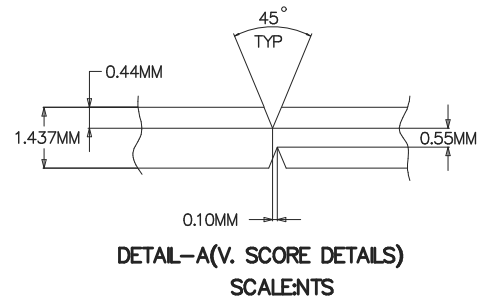
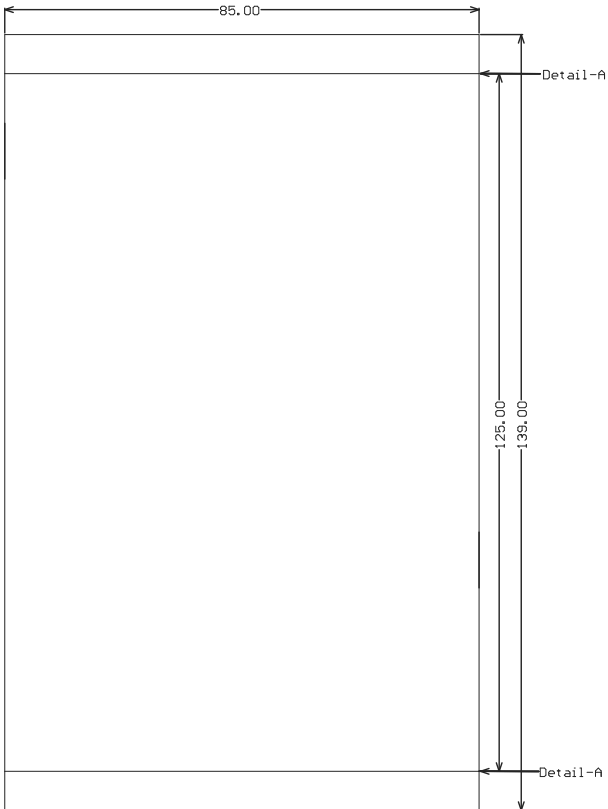

ALL ARTWORK VIEWED FROM TOP SIDE	BOARD #: PROC113	REV: D	SUN REV: Not In VersionControl
LAYER NAME = <small>R1 Board Outline R2 Board Dimensions</small>	TID #: N/A		
PLOT NAME = Board Dimensions	GENERATED : 1/19/2023 11:57:23 AM	TEXAS INSTRUMENTS	

## IMPORTANT NOTICE AND DISCLAIMER

TI PROVIDES TECHNICAL AND RELIABILITY DATA (INCLUDING DATA SHEETS), DESIGN RESOURCES (INCLUDING REFERENCE DESIGNS), APPLICATION OR OTHER DESIGN ADVICE, WEB TOOLS, SAFETY INFORMATION, AND OTHER RESOURCES "AS IS" AND WITH ALL FAULTS, AND DISCLAIMS ALL WARRANTIES, EXPRESS AND IMPLIED, INCLUDING WITHOUT LIMITATION ANY IMPLIED WARRANTIES OF MERCHANTABILITY, FITNESS FOR A PARTICULAR PURPOSE OR NON-INFRINGEMENT OF THIRD PARTY INTELLECTUAL PROPERTY RIGHTS.

These resources are intended for skilled developers designing with TI products. You are solely responsible for (1) selecting the appropriate TI products for your application, (2) designing, validating and testing your application, and (3) ensuring your application meets applicable standards, and any other safety, security, regulatory or other requirements.

These resources are subject to change without notice. TI grants you permission to use these resources only for development of an application that uses the TI products described in the resource. Other reproduction and display of these resources is prohibited. No license is granted to any other TI intellectual property right or to any third party intellectual property right. TI disclaims responsibility for, and you will fully indemnify TI and its representatives against, any claims, damages, costs, losses, and liabilities arising out of your use of these resources.

TI's products are provided subject to [TI's Terms of Sale](#) or other applicable terms available either on [ti.com](https://www.ti.com) or provided in conjunction with such TI products. TI's provision of these resources does not expand or otherwise alter TI's applicable warranties or warranty disclaimers for TI products.

TI objects to and rejects any additional or different terms you may have proposed.

Mailing Address: Texas Instruments, Post Office Box 655303, Dallas, Texas 75265  
Copyright © 2024, Texas Instruments Incorporated