

PMP10743-Test Report
Wide V_{IN} , 3 Output Rail Design
LMR14050 SIMPLE SWITCHER® Converter
LMZ20502 SIMPLE SWITCHER® Nano Module

Overview

The reference design below shows the wide input voltage capability, simple layout, and small solution size of the LMR14050 SIMPLE SWITCHER® Buck Converter and the LMZ20502 Nano Module. Figure 1 can be seen below and shows the block diagram for this design. The LMR14050 provides a 5V output rail which feeds into two LMZ20502 Nano Modules. The modules provide a 3.3V and a 1.8V rail. The 5V, the 3.3V, and the 1.8V rails are capable of delivering a maximum of 2A load at their respective output voltages.

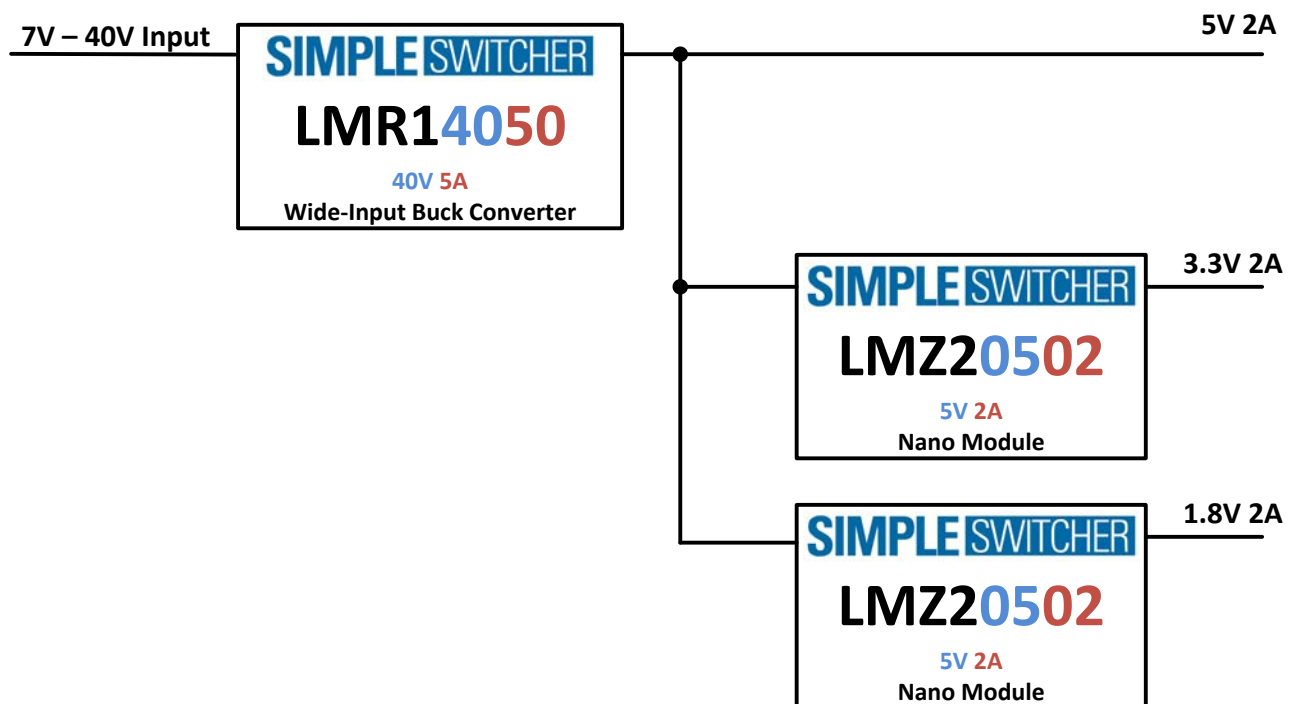

Figure 1. Block Diagram

Table of Contents

Overview	1
Design Specifications	3
Schematic	3
Board Layout	4
Bill Of Materials	9
Other Design Details	11
Controlling Precision Enable.....	11
Setting Switch Frequency	12
Typical Performance	13
Converter Efficiency at Various Loads.....	13
Startup.....	14
Shutdown.....	16
Output Voltage Ripple.....	18
Load Transients	24
Line Transients.....	27
Thermal Performance with Various Input Voltages and Loads	29

Design Specifications

Input Voltage: 7V to 40V

Output 1 Voltage: 5V

Output 1 Current: 2A

Output 2 Voltage: 3.3V

Output 2 Current: 2A

Output 3 Voltage: 1.8V

Output 3 Current: 2A

Schematic

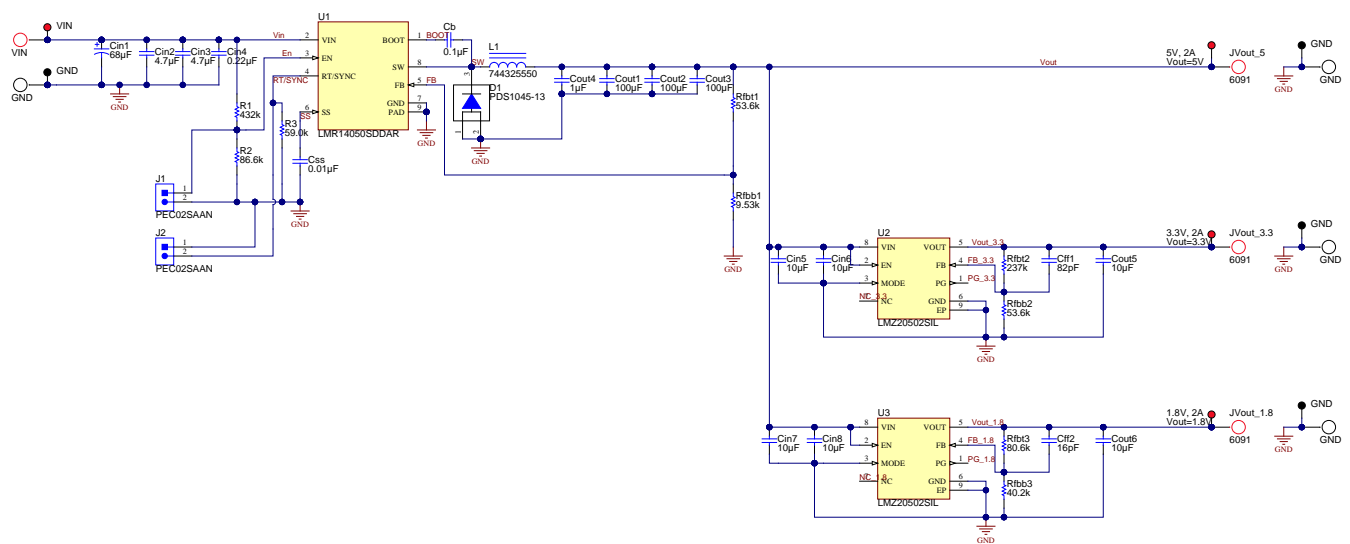

Figure 2. Schematic

Board Layout

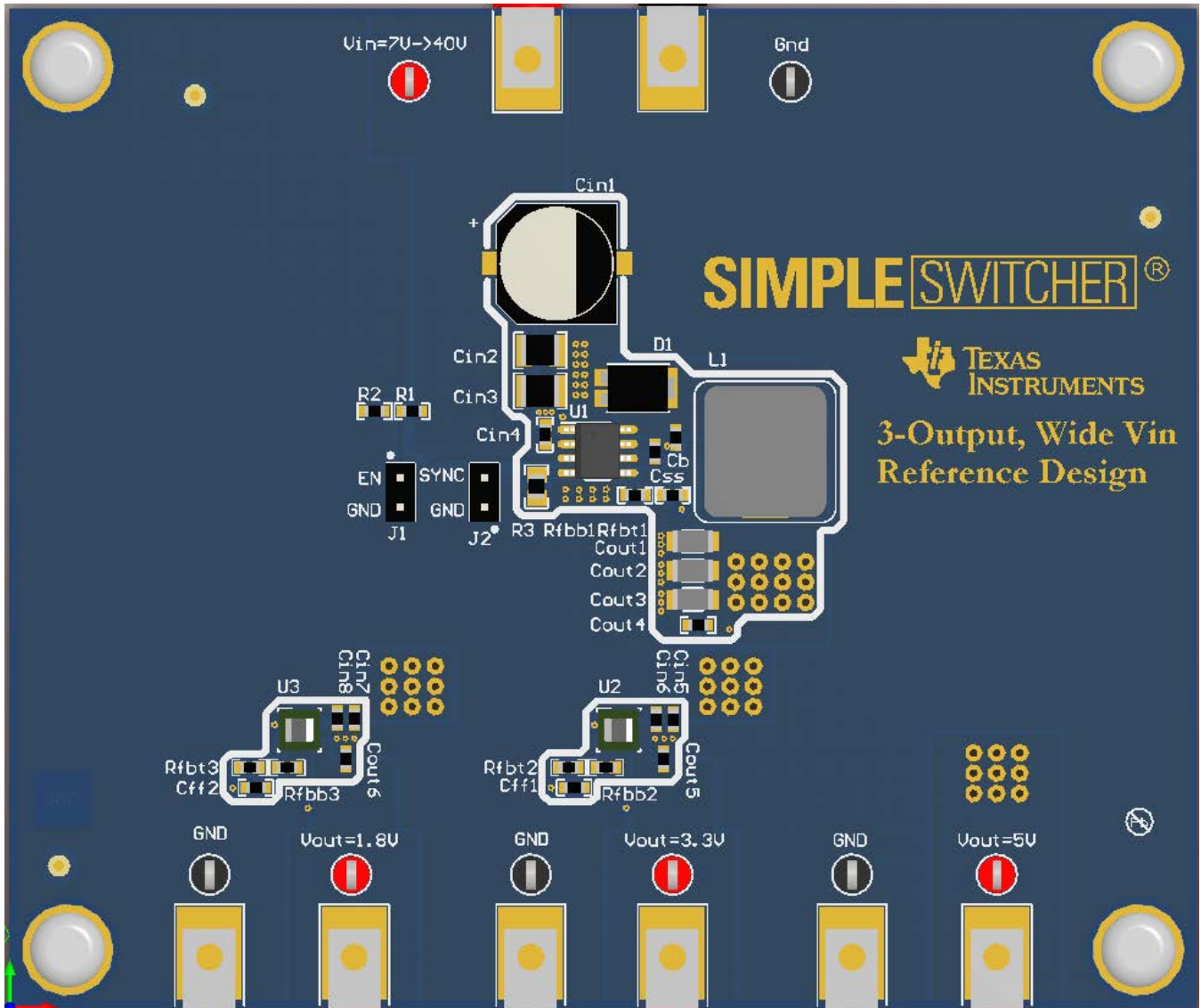

Figure 3. PCB Layout (3D View)

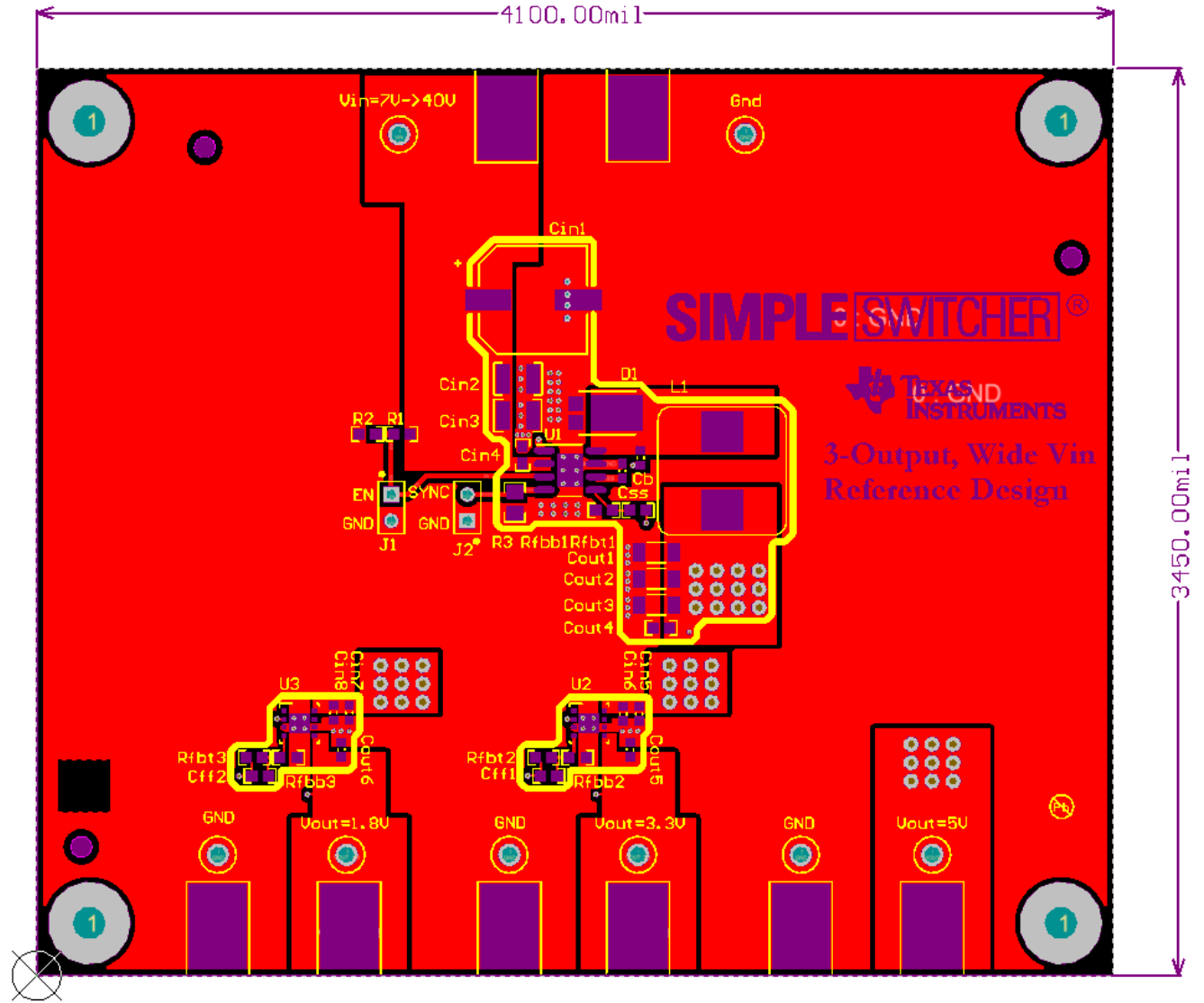

Figure 4. Top Layer Copper with Top Overlay and Top Solder

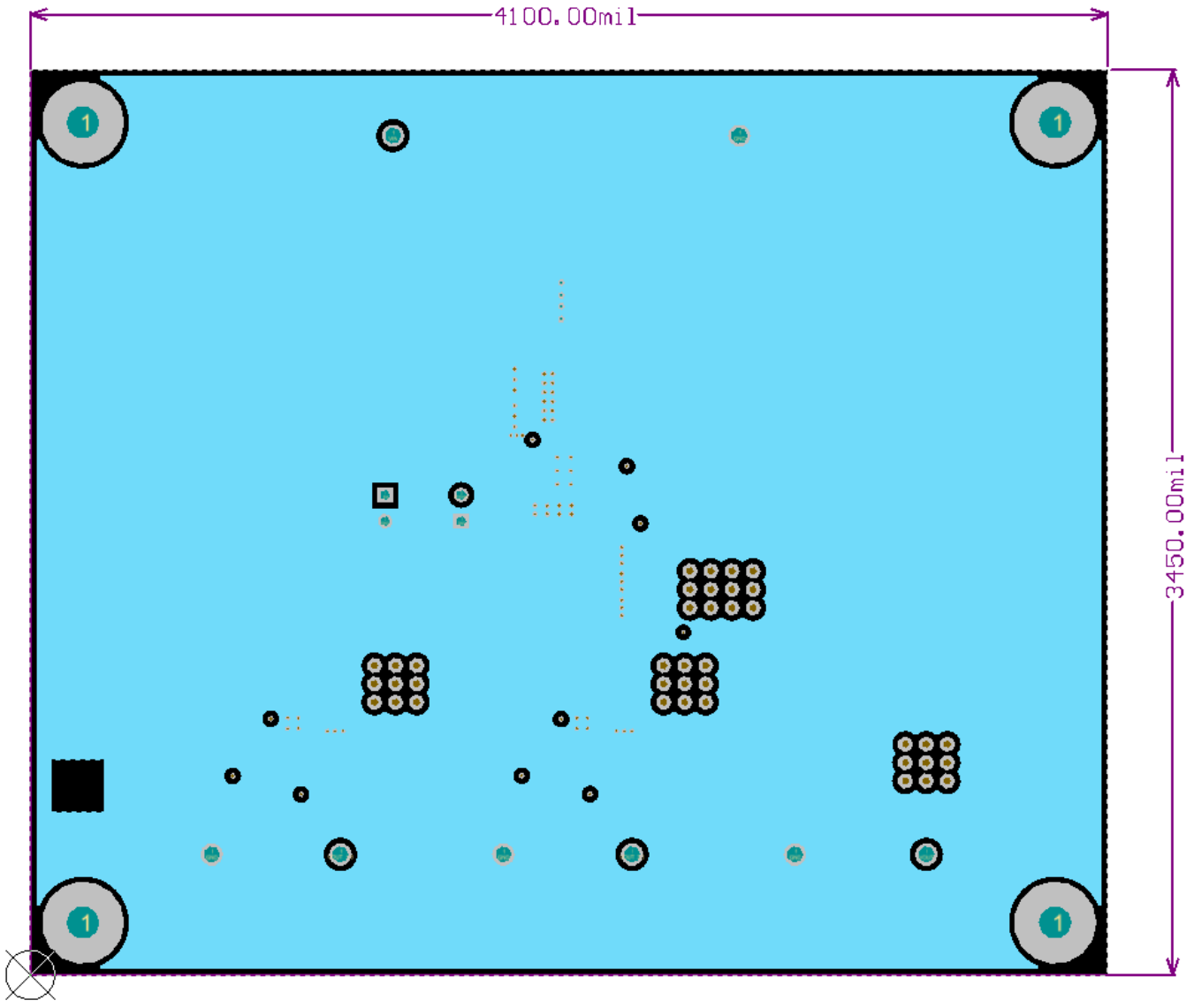

Figure 5. Mid Layer 1 Copper

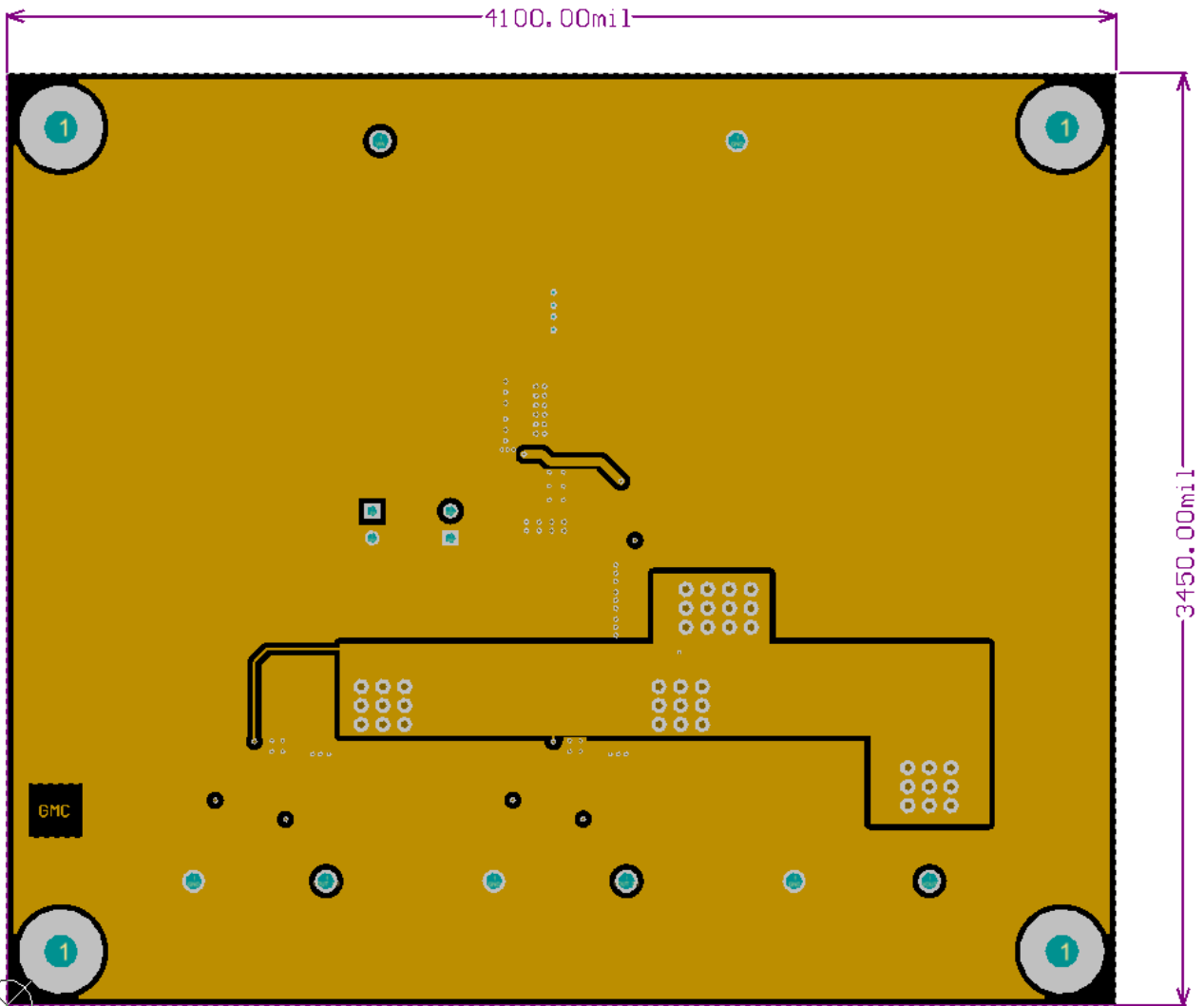

Figure 6. Mid Layer 2 Copper

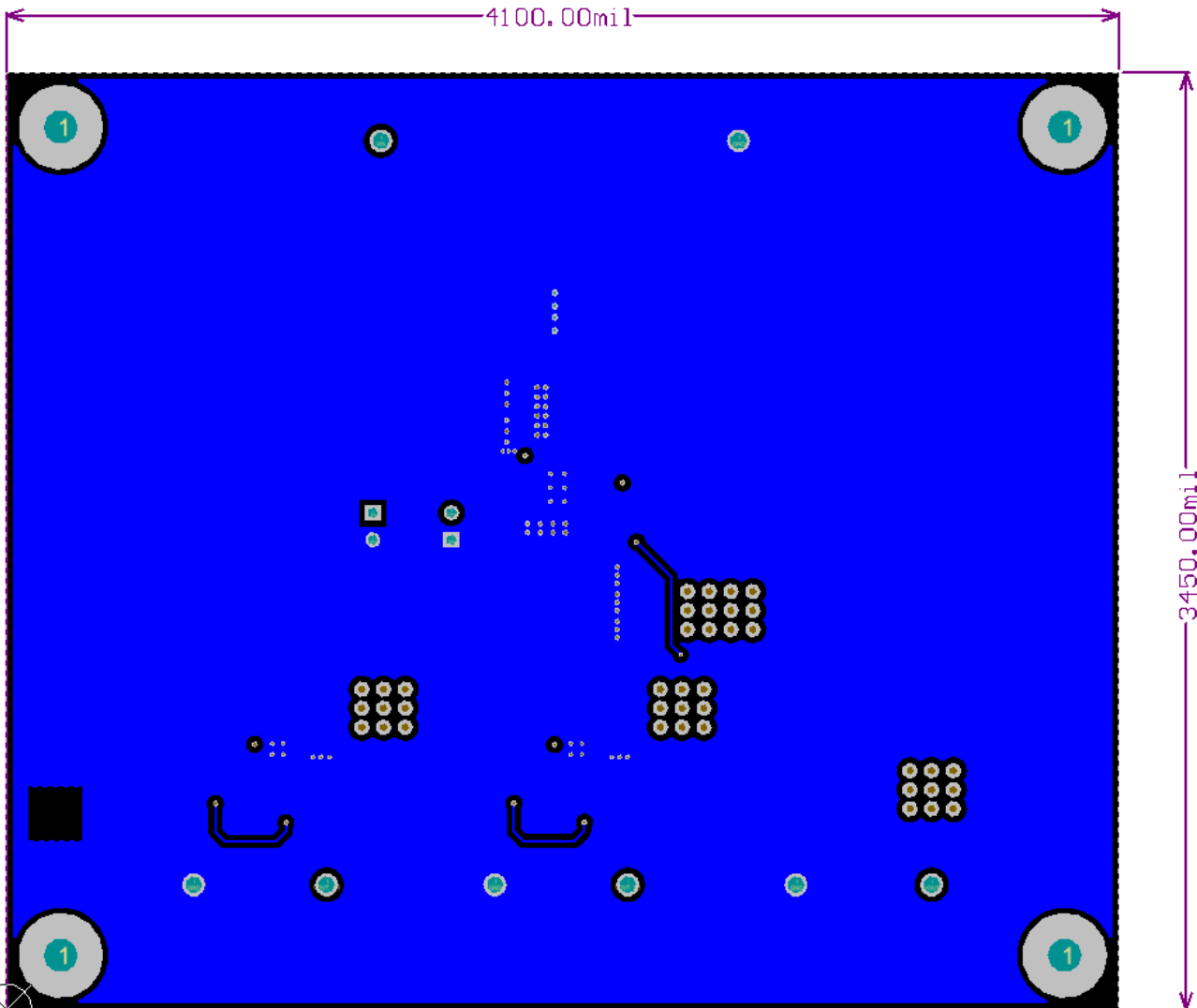

Figure 7. Bottom Layer Copper

Bill of Materials

Qty	Reference	Part Description	Manufacturer	Manufacturer Part Number
1	Cb	CAP, CERM, 0.1 μ F, 25 V, +/- 10%, X7R, 0603	MuRata	GRM188R71E104KA01D
1	Cff1	CAP, CERM, 82 pF, 50 V, +/- 5%, C0G/NP0, 0603	AVX	06035A820JAT2A
1	Cff2	CAP, CERM, 16 pF, 50 V, +/- 5%, C0G/NP0, 0603	MuRata	GRM1885C1H160JA01D
1	Cin1	CAP, Polymer, 68 μ F, 50 V, +/- 20%, 0.02 ohm, F12, SMD, 2-Leads, Body 10.5x10.5mm, Height 12.7mm SMD	Panasonic	50SVPF68M
2	Cin2, Cin3	CAP, CERM, 4.7 μ F, 50 V, +/- 10%, X7R, 1210	MuRata	GRM32ER71H475KA88L
1	Cin4	CAP, CERM, 0.22 μ F, 50 V, +/- 10%, X7R, 0603	TDK	C1608X7R1H224K080AB
6	Cin5, Cin6, Cin7, Cin8, Cout5, Cout6	CAP, CERM, 10 μ F, 16 V, +/- 20%, X5R, 0603	Taiyo Yuden	EMK107BBJ106MA-T
3	Cout1, Cout2, Cout3	CAP, CERM, 100 μ F, 10 V, +/- 20%, X5R, 1206_190	TDK	C3216X5R1A107M160AC
1	Cout4	CAP, CERM, 1 μ F, 16 V, +/- 10%, X5R, 0603	MuRata	GRM188R61C105KA93D
1	Css	CAP, CERM, 0.01 μ F, 16 V, +/- 10%, X7R, 0603	MuRata	GRM188R71C103KA01D
1	D1	Diode, Schottky, 45 V, 10 A, PowerDI5	Diodes Inc.	PDS1045-13
3	FID1, FID2, FID3	Fiducial mark. There is nothing to buy or mount.	N/A	N/A
4	H1, H2, H3, H4	Machine Screw, Round, #4-40 x 1/4, Nylon, Philips panhead	B&F Fastener Supply	NY PMS 440 0025 PH
4	H5, H6, H7, H8	Standoff, Hex, 0.5"L #4-40 Nylon	Keystone	1902C
2	J1, J2	Header, 100mil, 2x1, Tin, TH	Sullins Connector Solutions	PEC02SAAN
4	JVout_1.8, JVout_3.3, JVout_5, TP9	Standard Banana Jack, Insulated, Red	Keystone	6091
1	L1	Inductor, Shielded Drum Core, Superflux, 5.5 μ H, 10 A, 0.0112 ohm, SMD	Würth Elektronik	744325550
1	R1	RES, 432 k, 1%, 0.1 W, 0603	Vishay-Dale	CRCW0603432KFKEA
1	R2	RES, 86.6 k, 1%, 0.1 W, 0603	Vishay-Dale	CRCW060386K6FKEA
1	R3	RES, 59.0 k, 1%, 0.125 W, 0805	Vishay-Dale	CRCW080559K0FKEA
1	Rfbb1	RES, 9.53 k, 1%, 0.1 W, 0603	Vishay-Dale	CRCW06039K53FKEA

PMP10743 Wide VIN, 3 Output Rail Design

2	Rfbb2, Rfbb1	RES, 53.6 k, 1%, 0.1 W, 0603	Vishay-Dale	CRCW060353K6FKEA
1	Rfbb3	RES, 40.2 k, 1%, 0.1 W, 0603	Vishay-Dale	CRCW060340K2FKEA
1	Rfbb2	RES, 237 k, 1%, 0.1 W, 0603	Vishay-Dale	CRCW0603237KFKEA
1	Rfbb3	RES, 80.6 k, 1%, 0.1 W, 0603	Vishay-Dale	CRCW060380K6FKEA
4	TP1, TP3, TP5, TP7	Standard Banana Jack, Insulated, Black	Keystone	6092
4	TP2, TP4, TP6, TP8	Test Point, Compact, Black, TH	Keystone	5006
4	TP10, Vout=1.8V, Vout=3.3V, Vout=5V	Test Point, Compact, Red, TH	Keystone	5005
1	U1	LMR14050SDDAR, DDA0008E	Texas Instruments	LMR14050SDDAR
2	U2, U3	2A Buck Simple Switcher Nano Module, SIL0008F	Texas Instruments	LMZ20502SIL

Other Design Details

Controlling Precision Enable

The enable jumper J1 on the PCB allows the user to gain control of the precision enable pin on the IC. By adjusting the values of R1 and R2, one can appropriately set the turn on and off thresholds of the converter. When the internal precision enable pin is pulled below 1.2V, the converter is shut off. The converter will delay its turn on until VIN reaches about 7V. By adding a resistor divider, the converter avoids attempting to regulate when the input voltage is too low to provide the proper output. As a result, the IC avoids current limiting the power supply during startup.

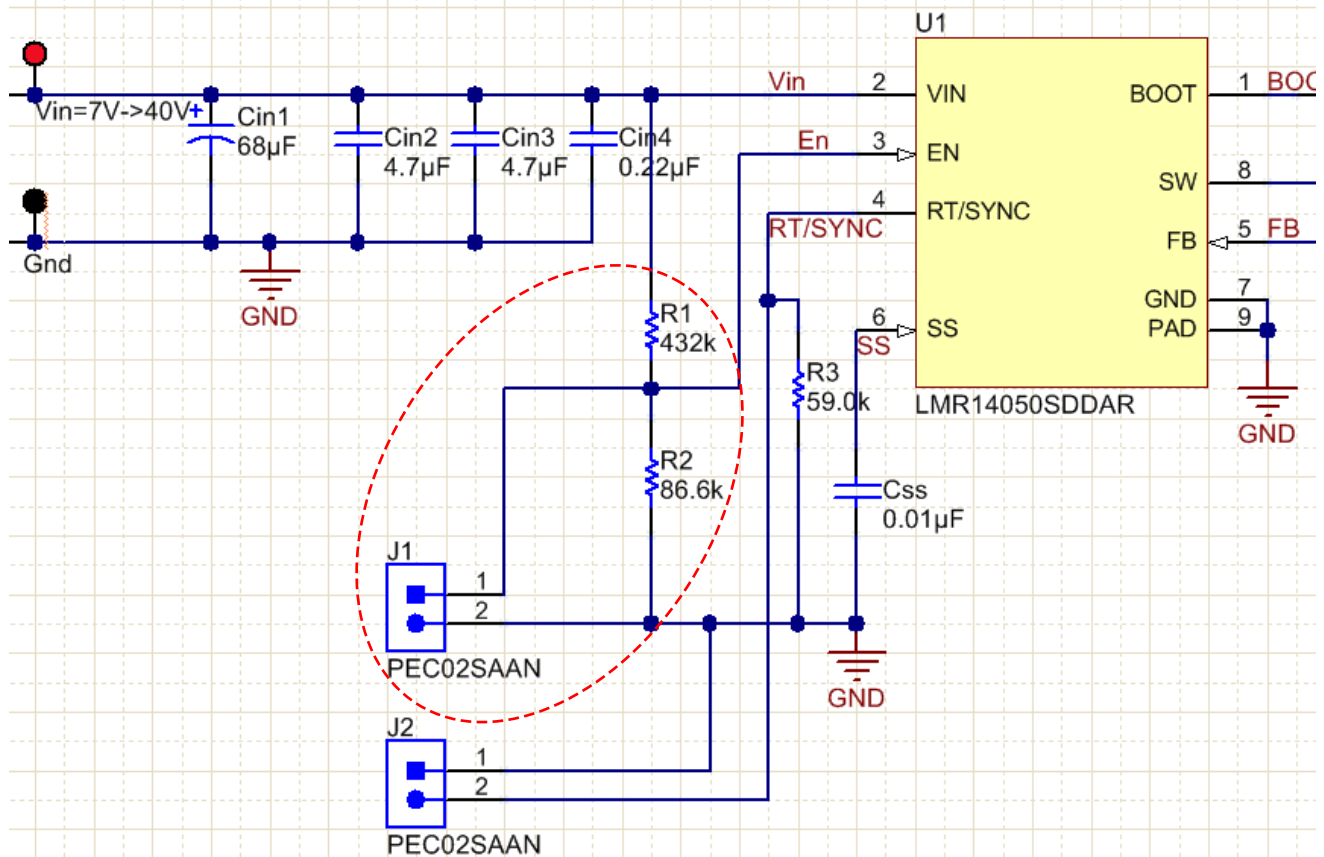

Figure 8. Controlling Turn-on Threshold

PMP10743 Wide VIN, 3 Output Rail Design

Setting the Switch Frequency

By changing the value of R3, the switching frequency of the LMR14050 can be adjusted and set to the desired value for the user's application. The switching frequency can also be controlled from 250kHz to 2.3MHz by hooking up an external clock to the SYNC pin J2. Refer to the LMR14050 datasheet for more information on connecting an external clock.

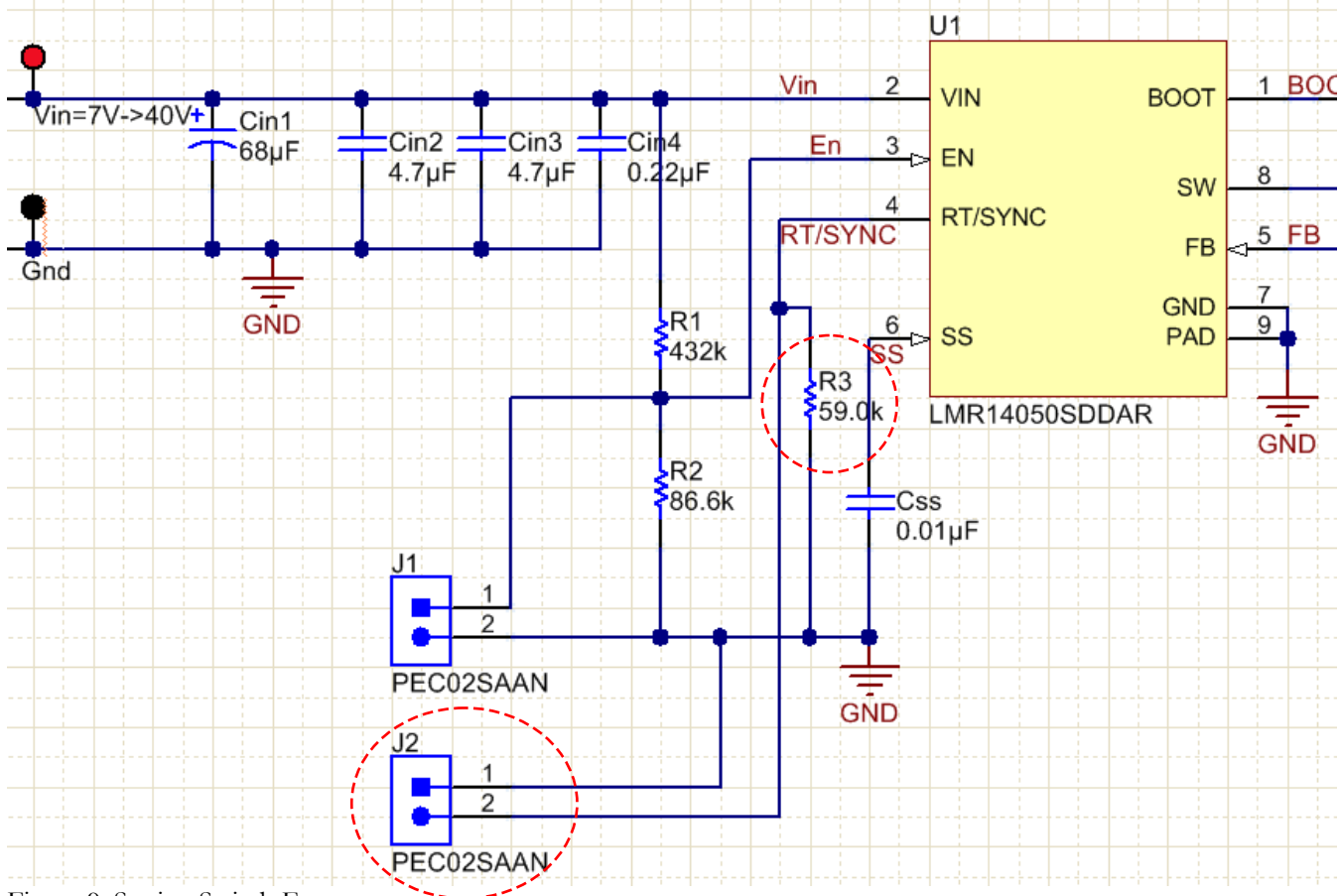

Figure 9. Setting Switch Frequency

Typical Performance

Converter Efficiency at Various Loads

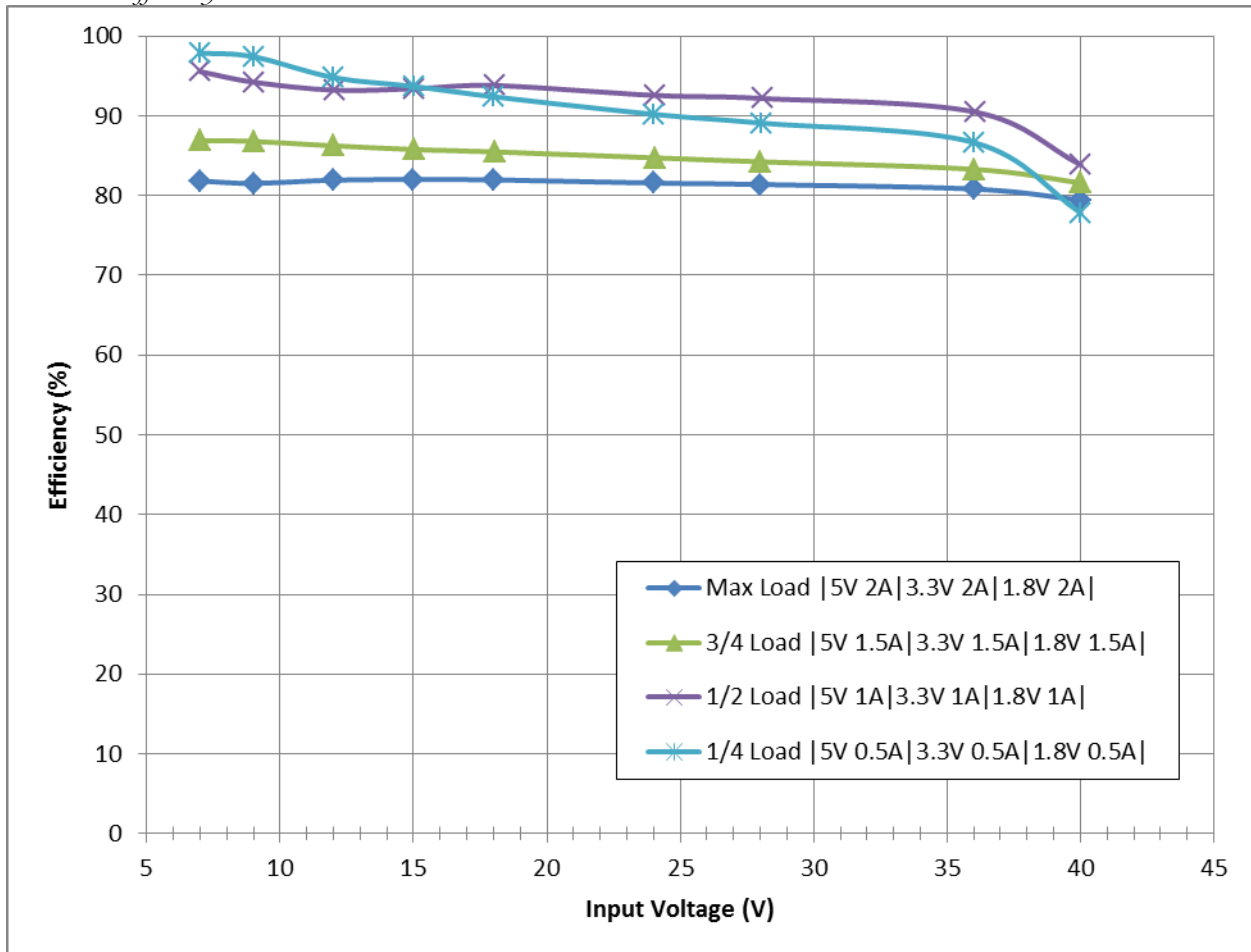

Figure 10. Efficiency

Startup

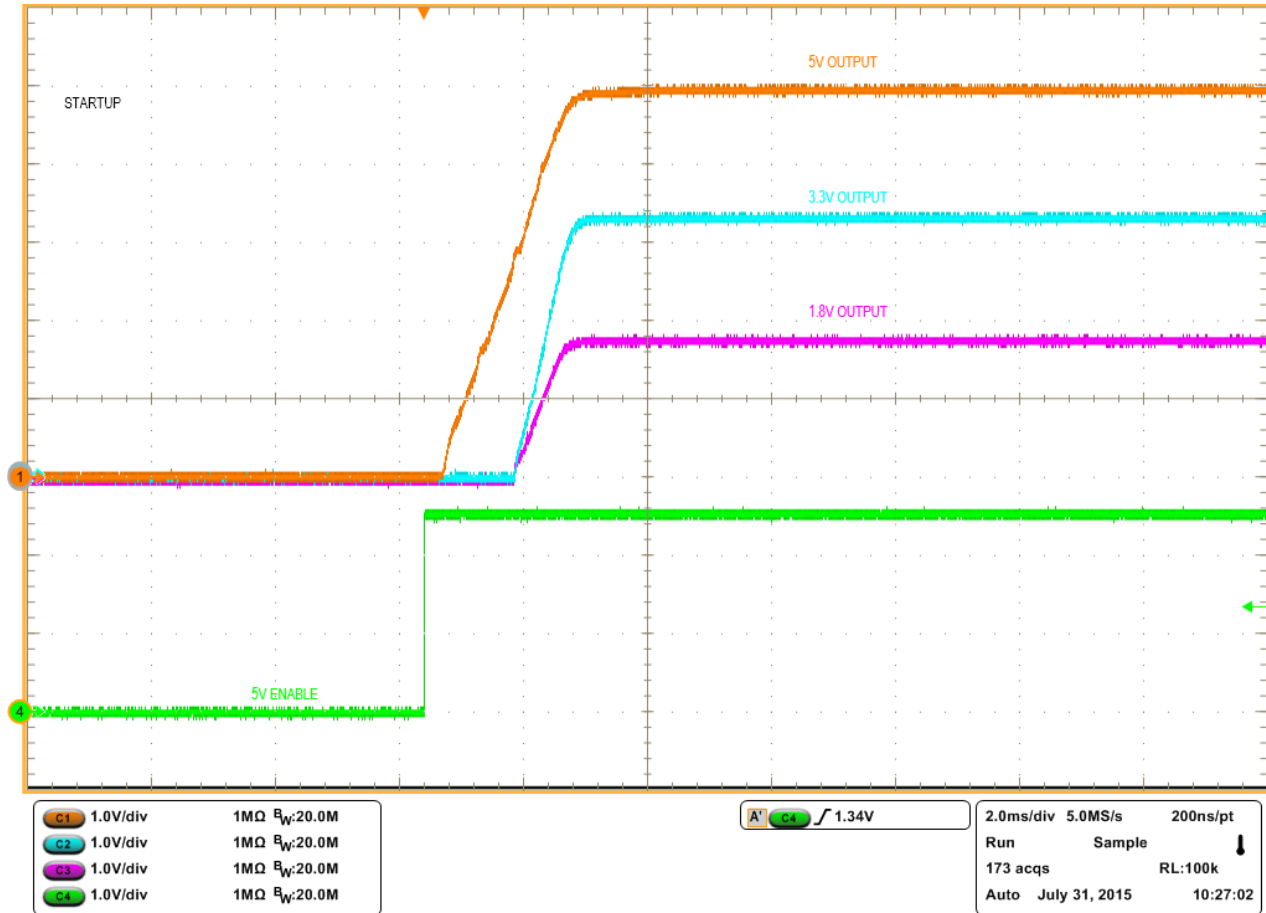

Figure 11. Startup at 12V Input

The 5V output ramps up first and enables both Nano Modules. The Nano Module's enable is tied to its VIN pin. As seen from Figure 9, each module is enabled when the output from the LMR14050 reaches about 2.8V. Note, that by varying the soft start capacitor (C_{SS}), one can adjust the converter's startup time.

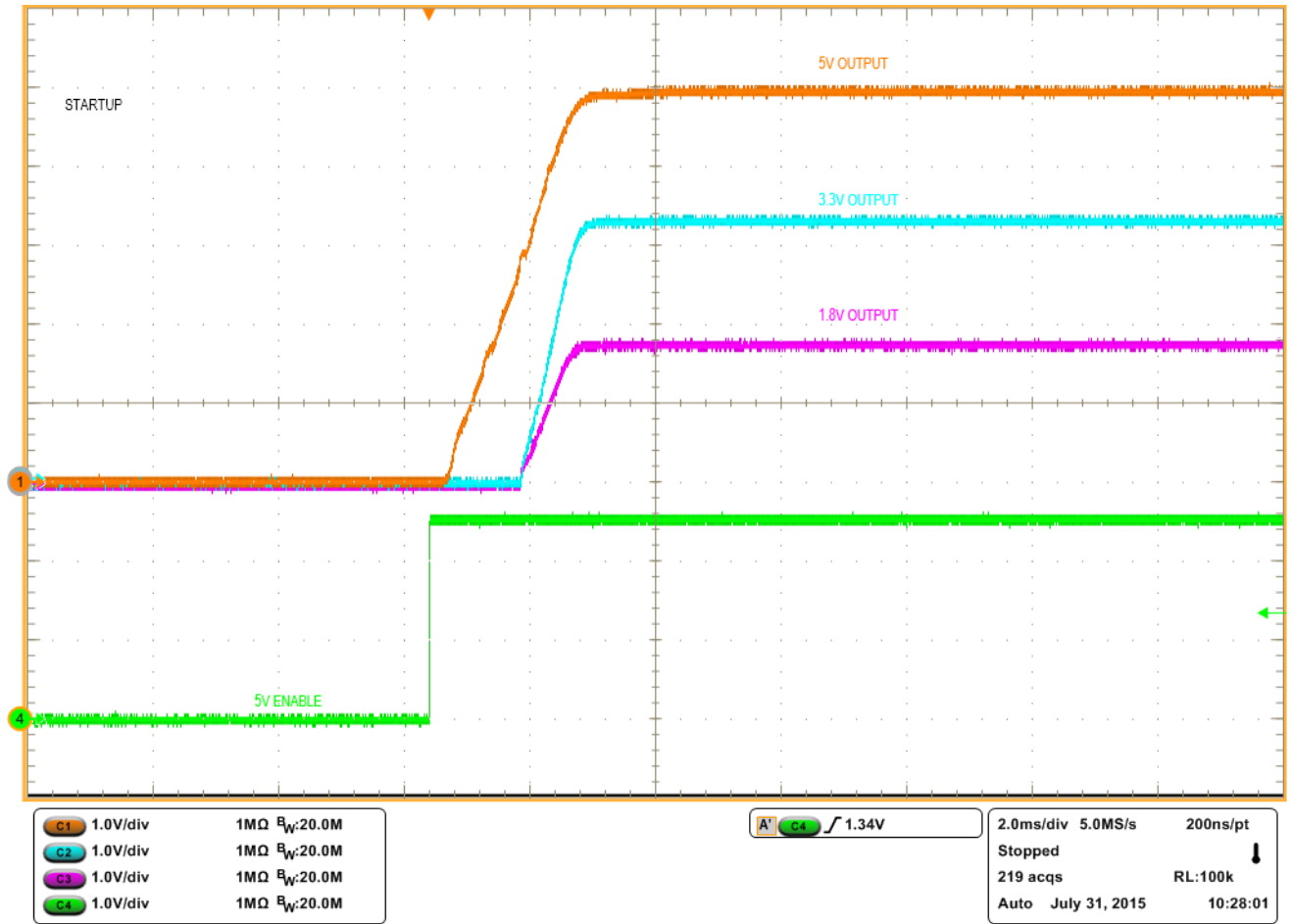

Figure 12. Startup at 24V Input

Shutdown

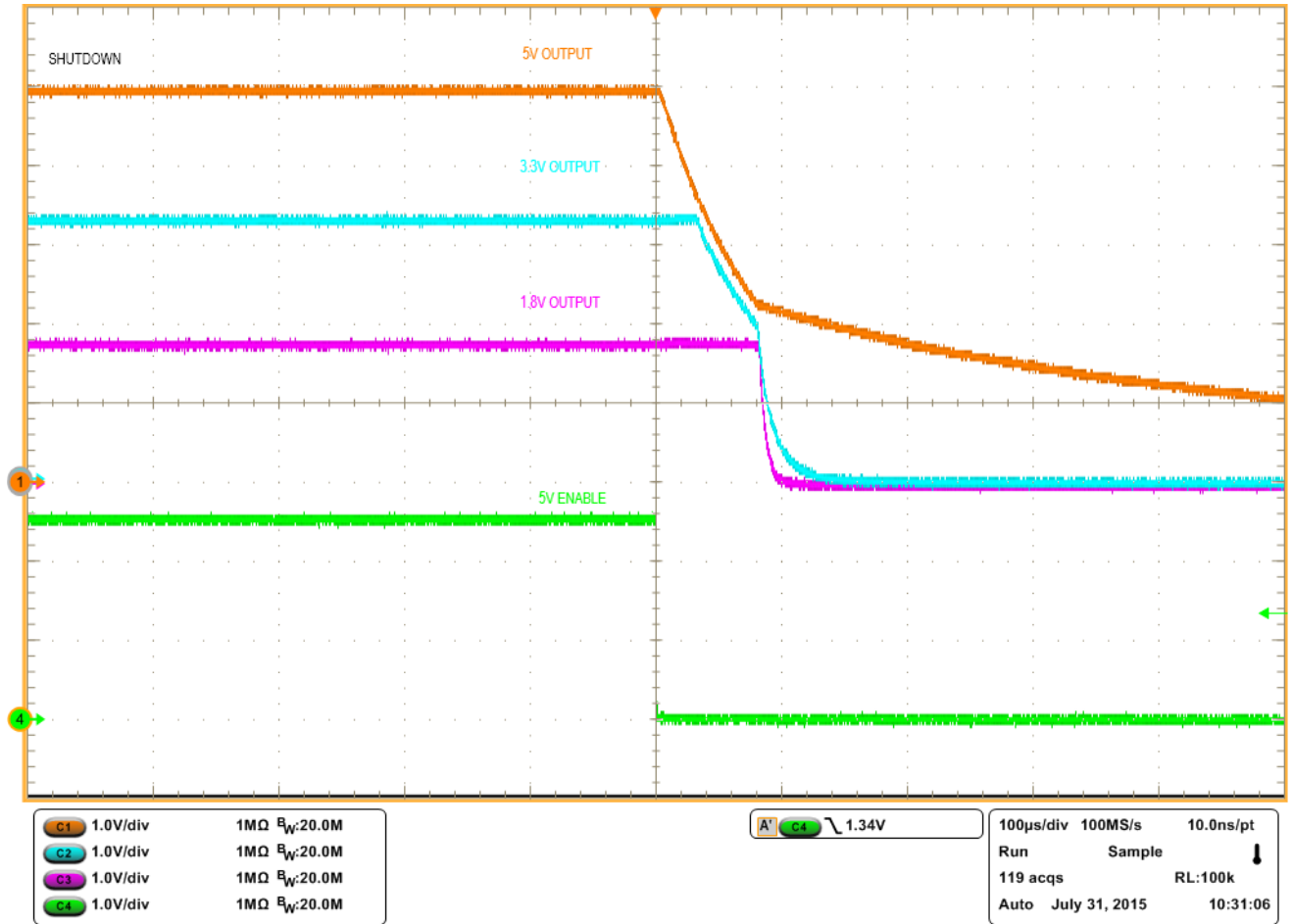

Figure 13. Shutdown at 12V Input

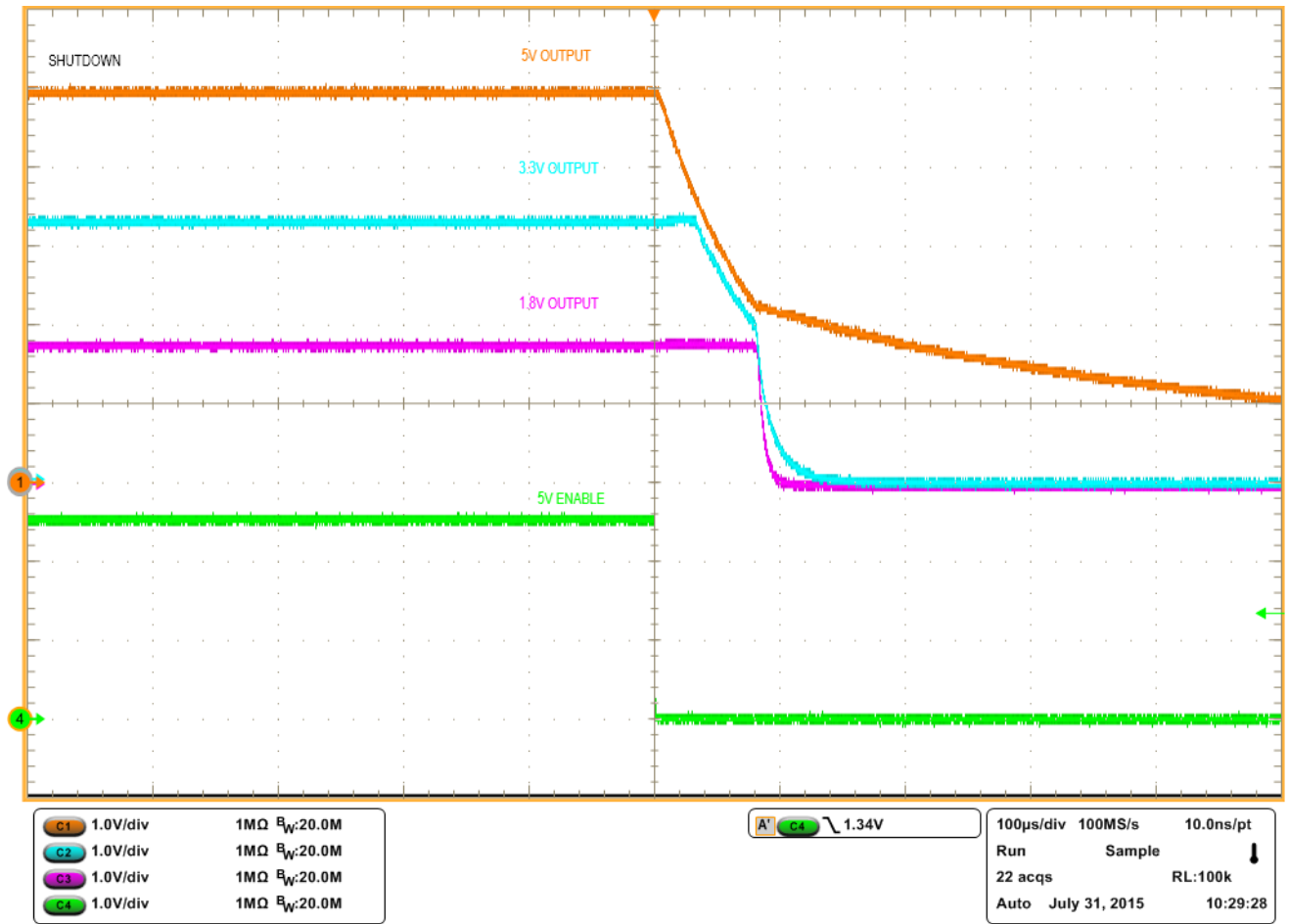

Figure 14. Shutdown at 24V Input

Output Voltage Ripple

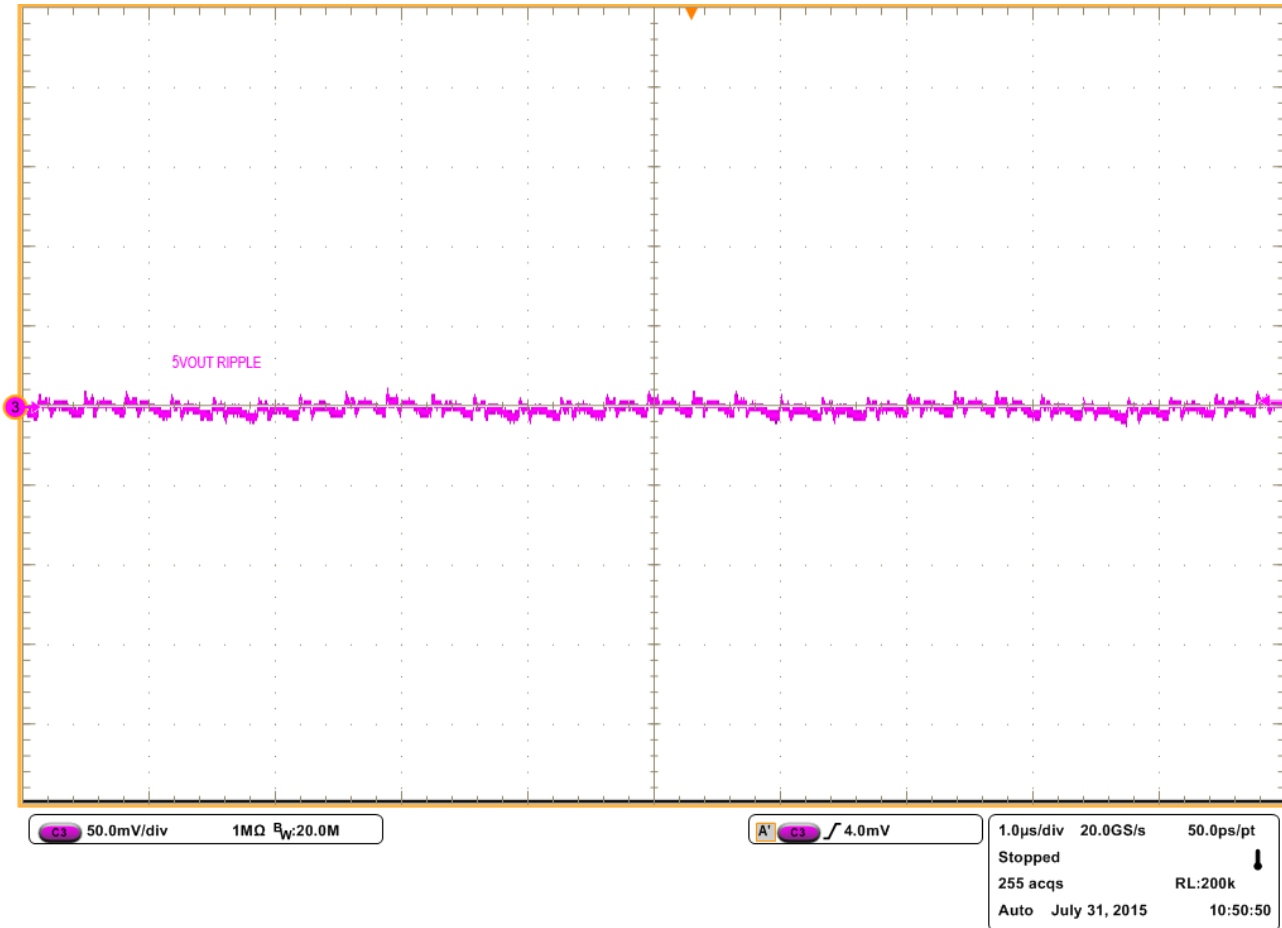

Figure 15. 5V Output Ripple

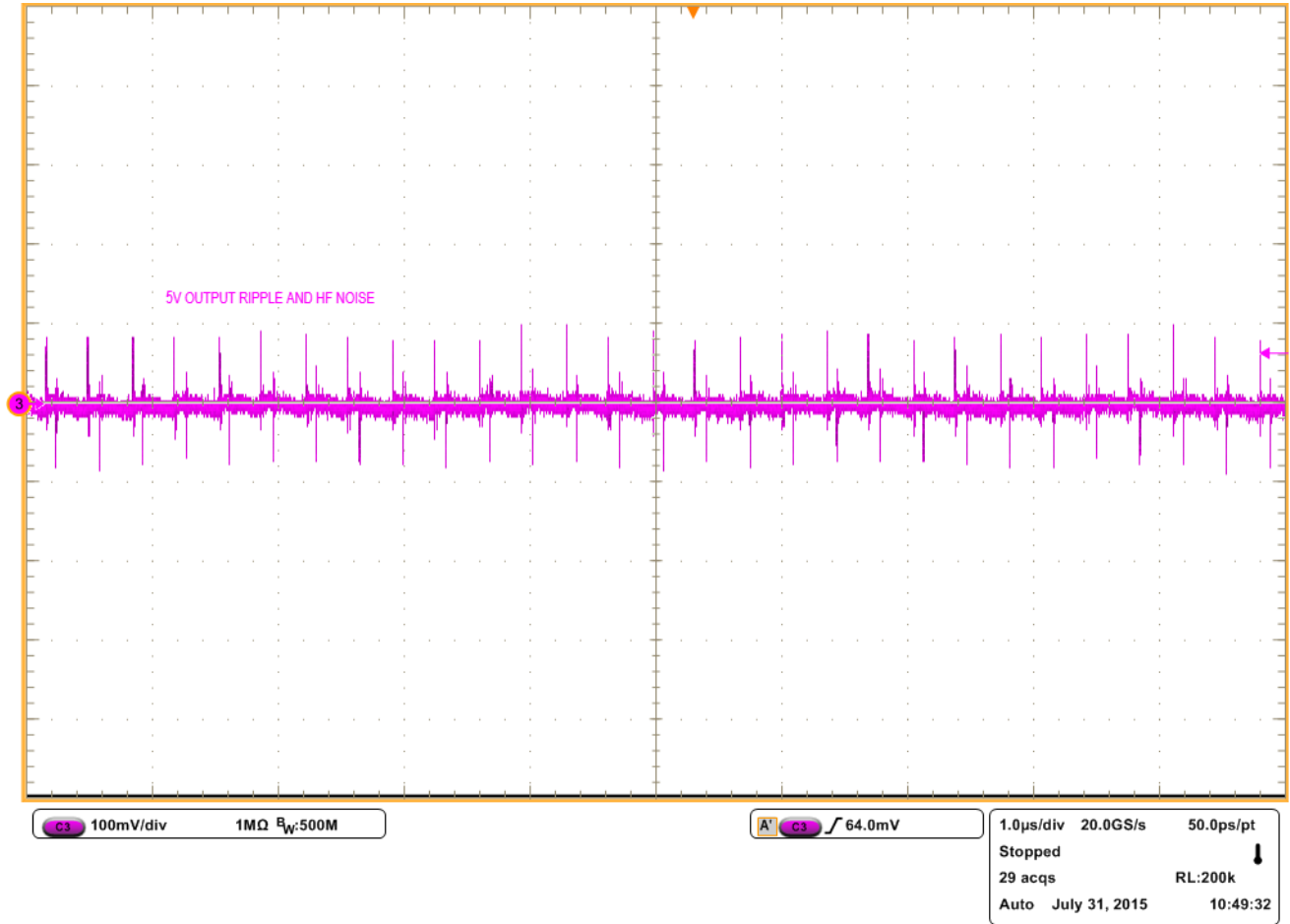

Figure 16. 5V Output Ripple and High Frequency Noise

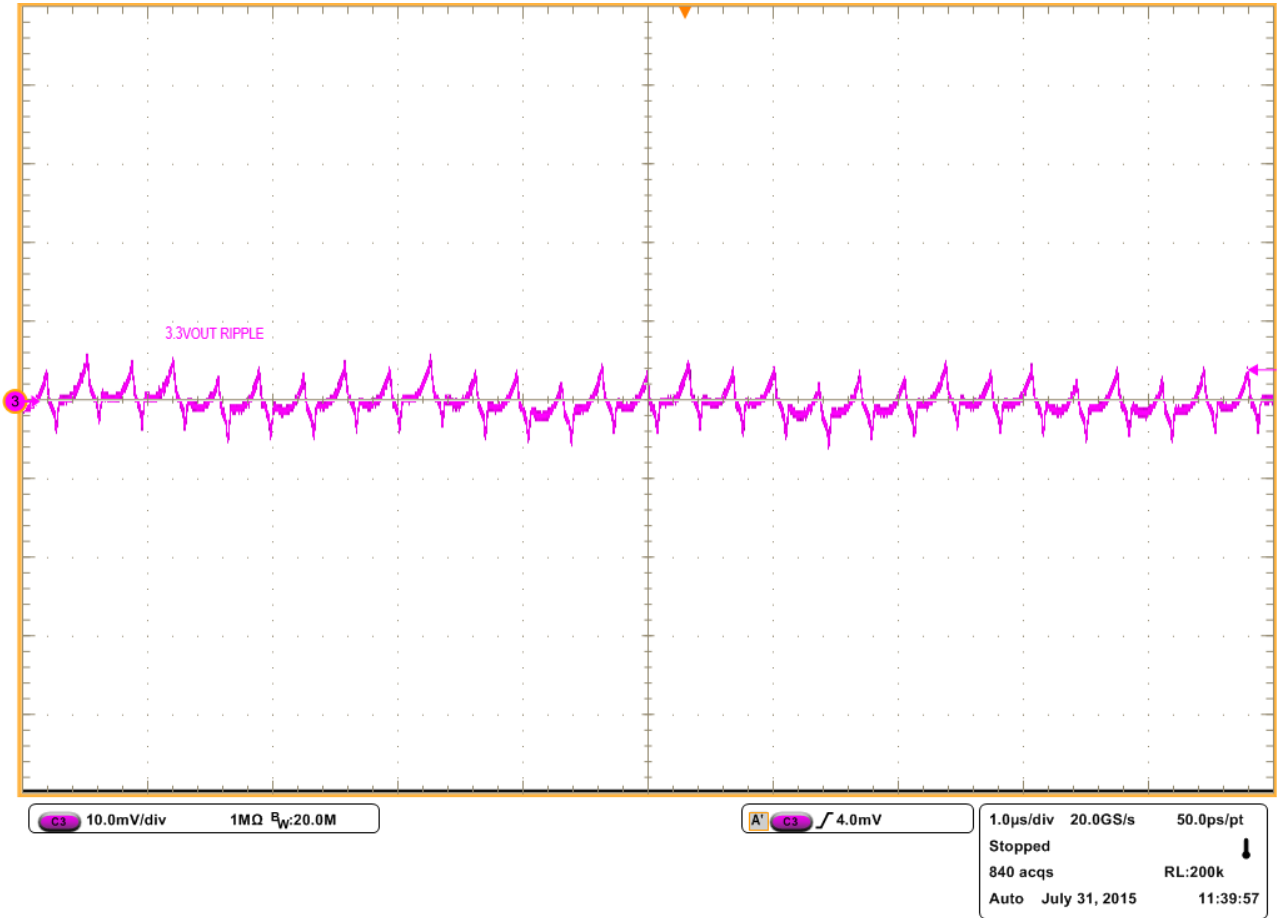

Figure 17. 3.3V Output Ripple

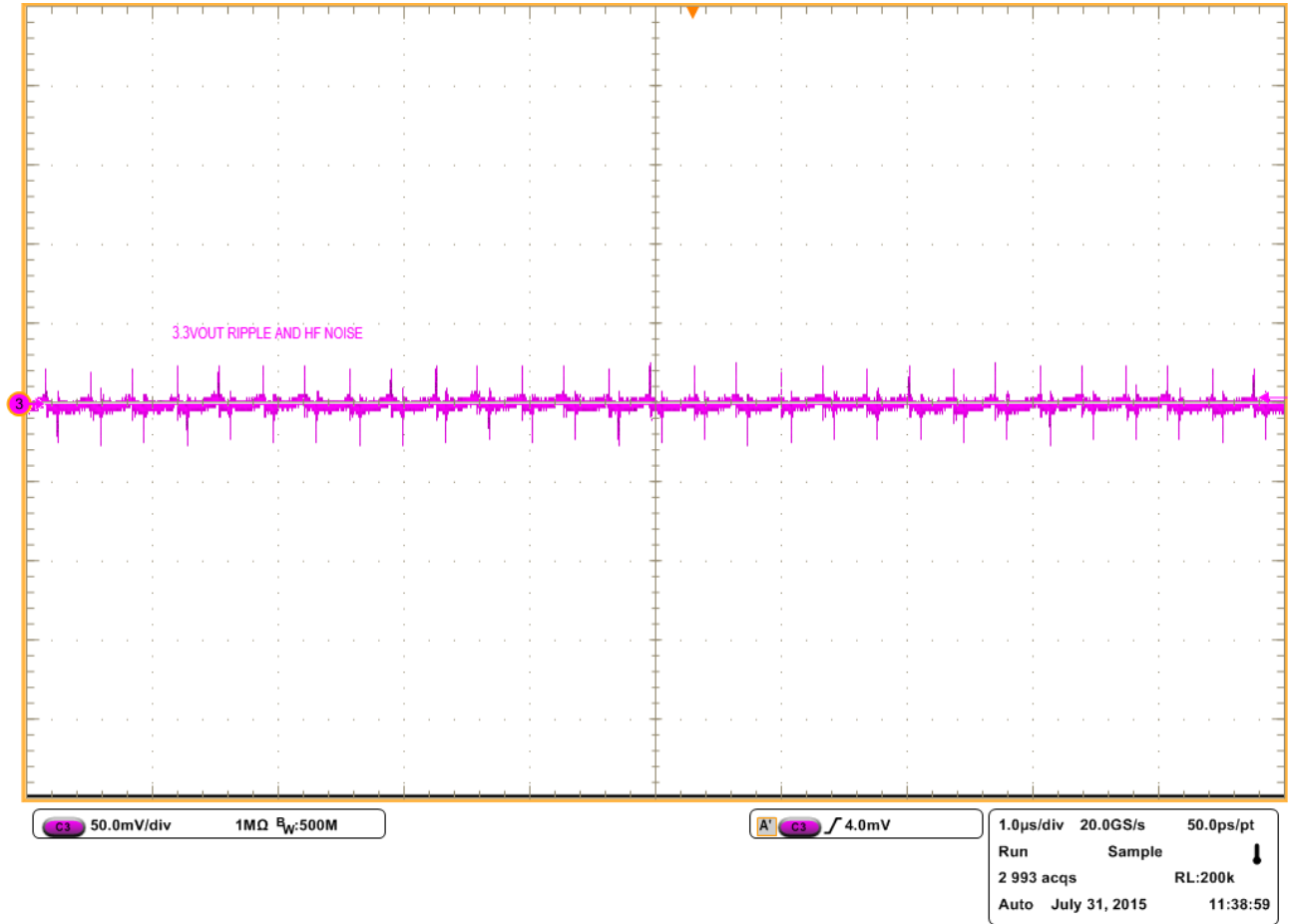

Figure 18. 3.3V Output Ripple and High Frequency Noise

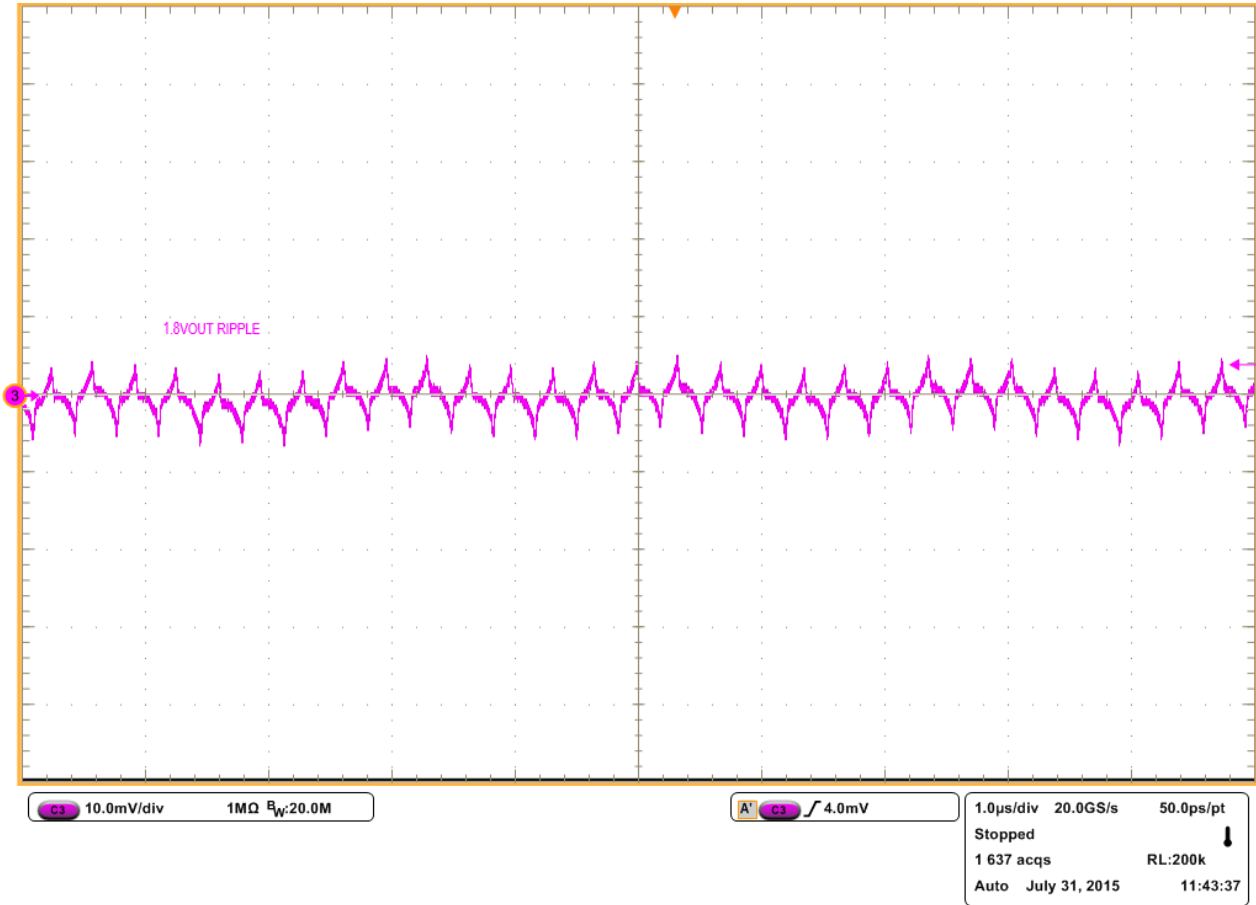

Figure 19. 1.8V Output Ripple

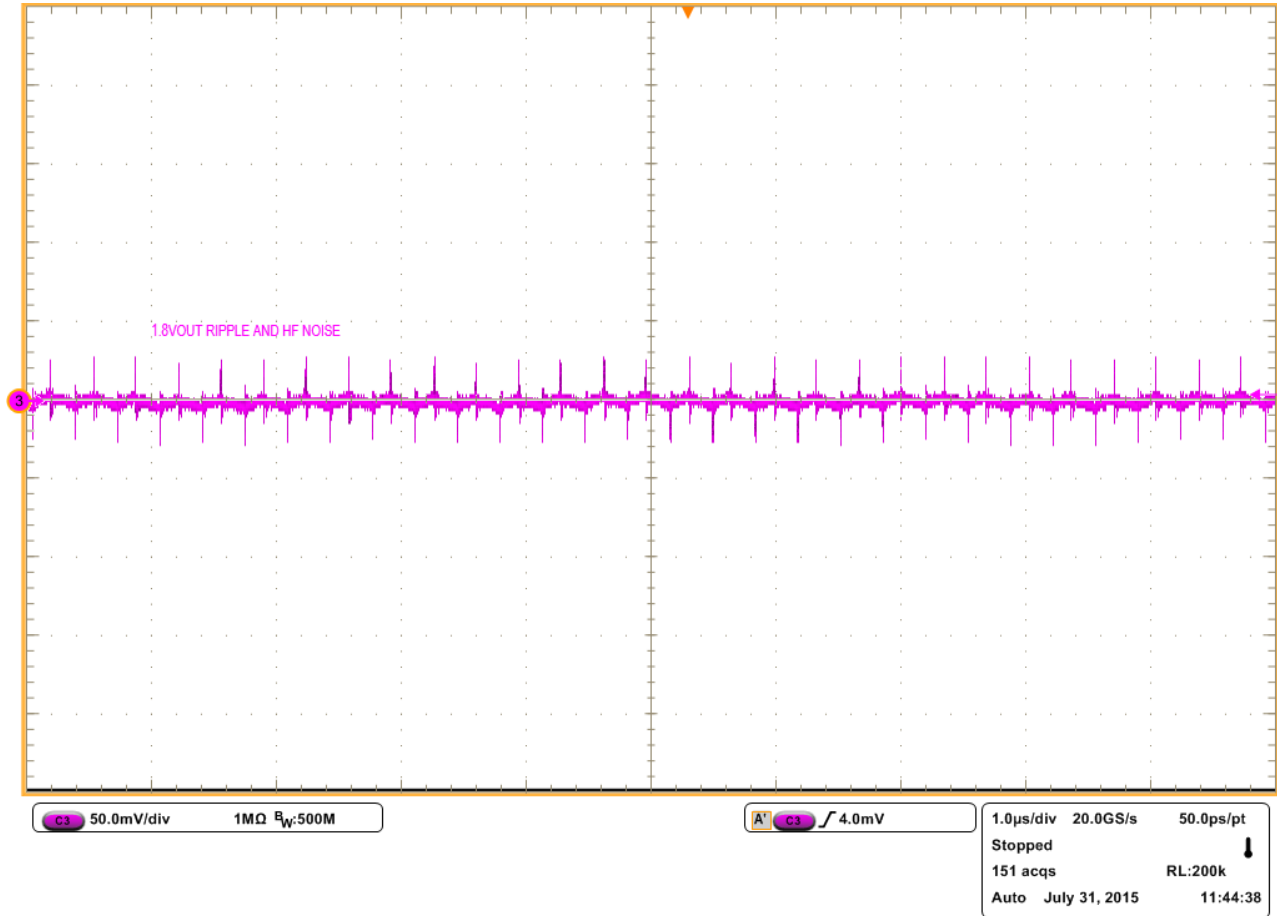

Figure 20. 1.8V Output Ripple and High Frequency Noise

Load Transients

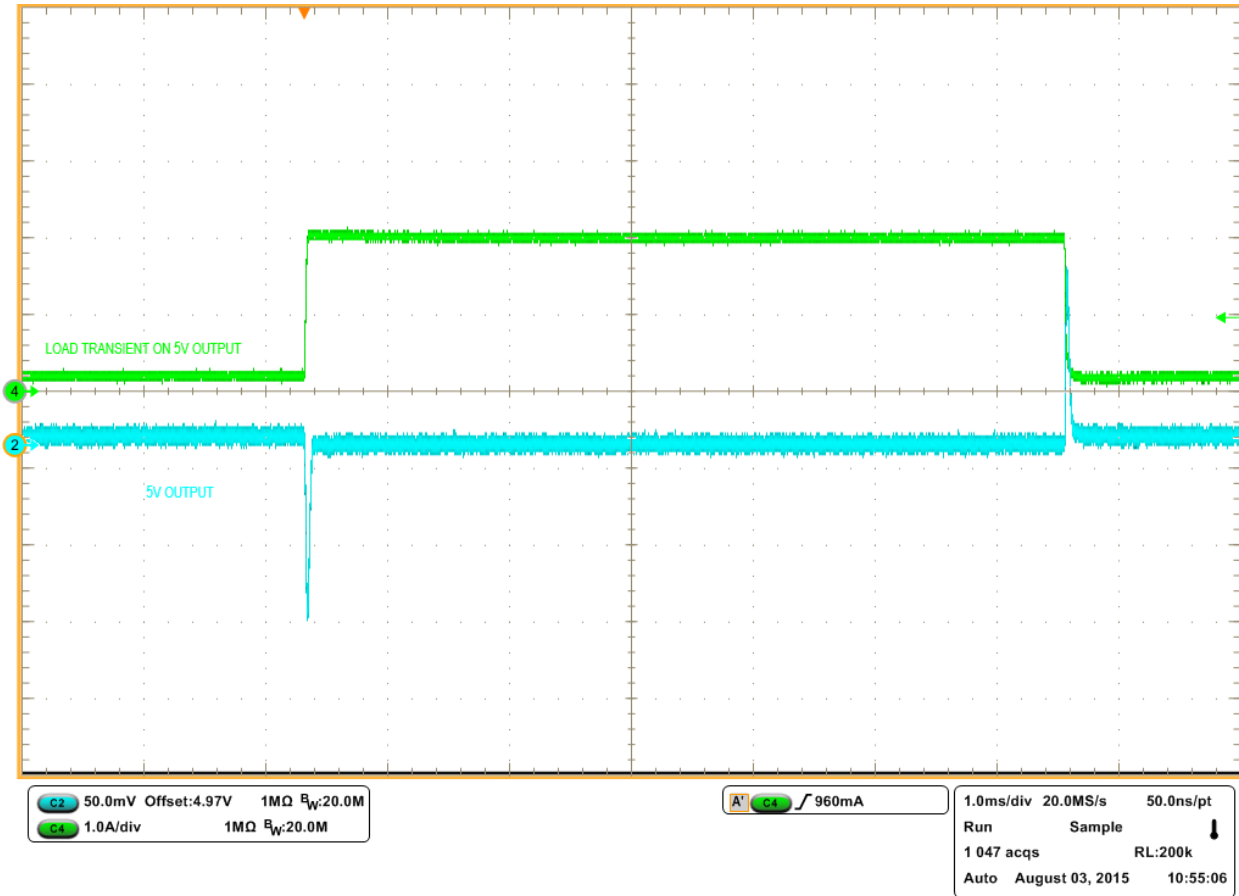

Figure 21. 10% to 100% Load Step on 5V Rail

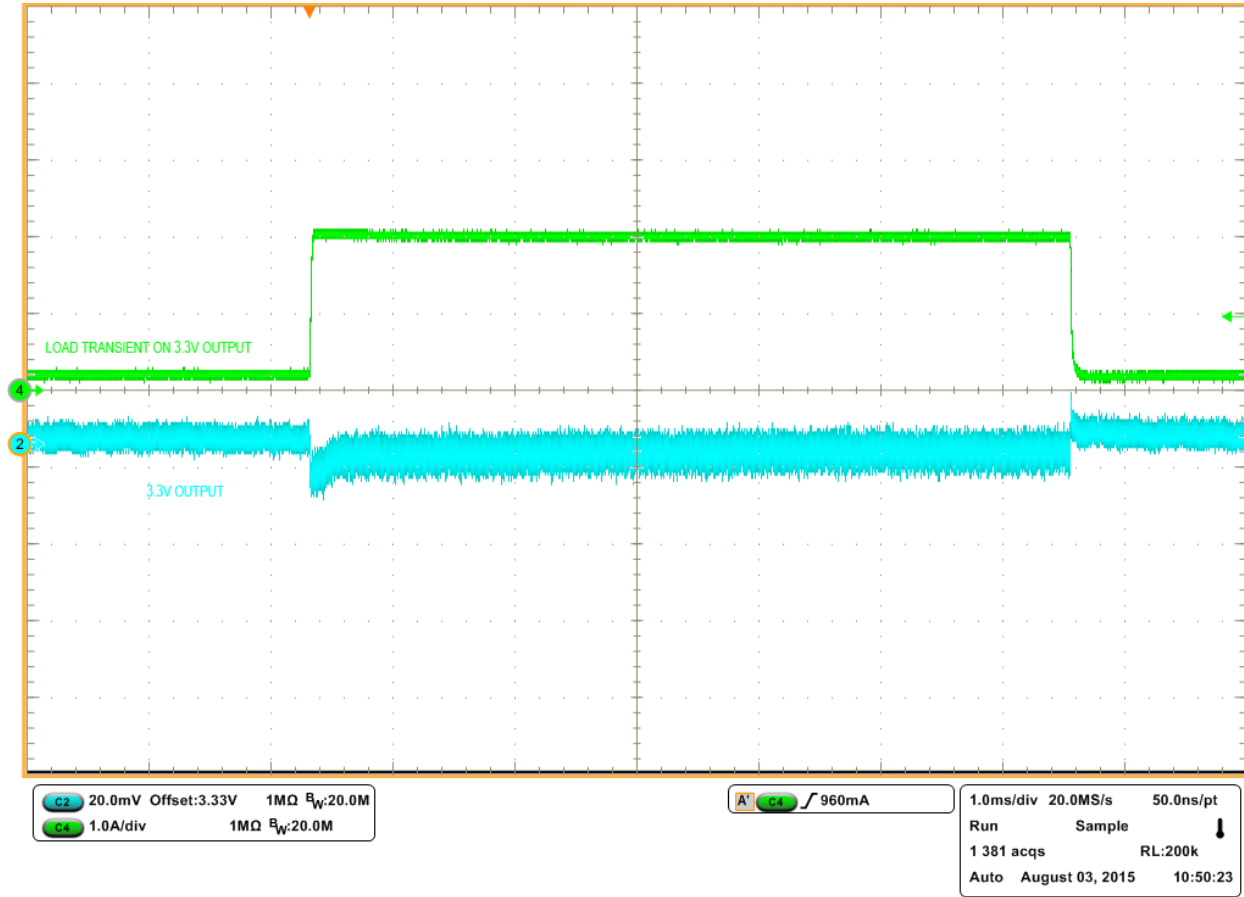

Figure 22. 10% to 100% Load Step on 3.3V Rail

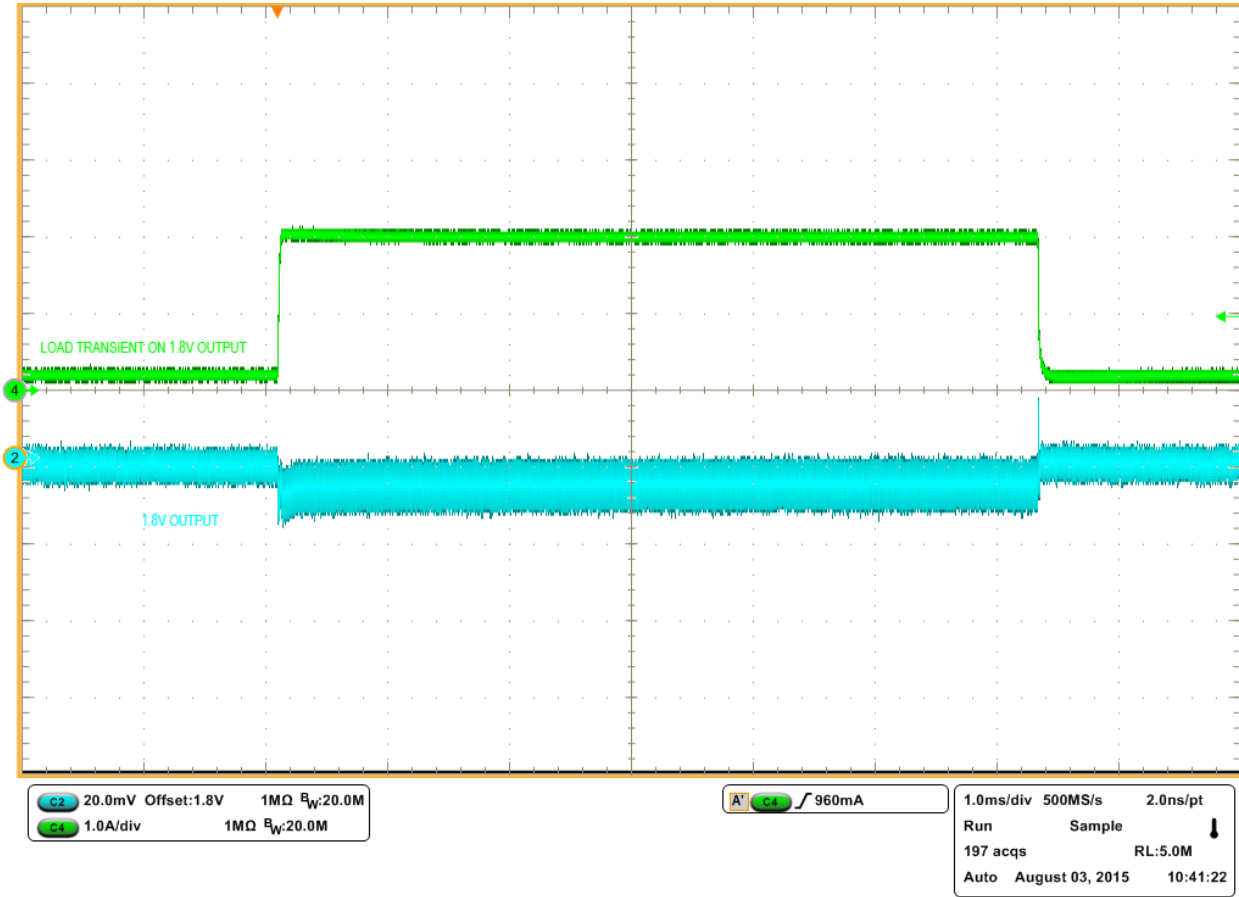

Figure 23. 10% to 100% Load Step on 1.8V Rail

Line Transients

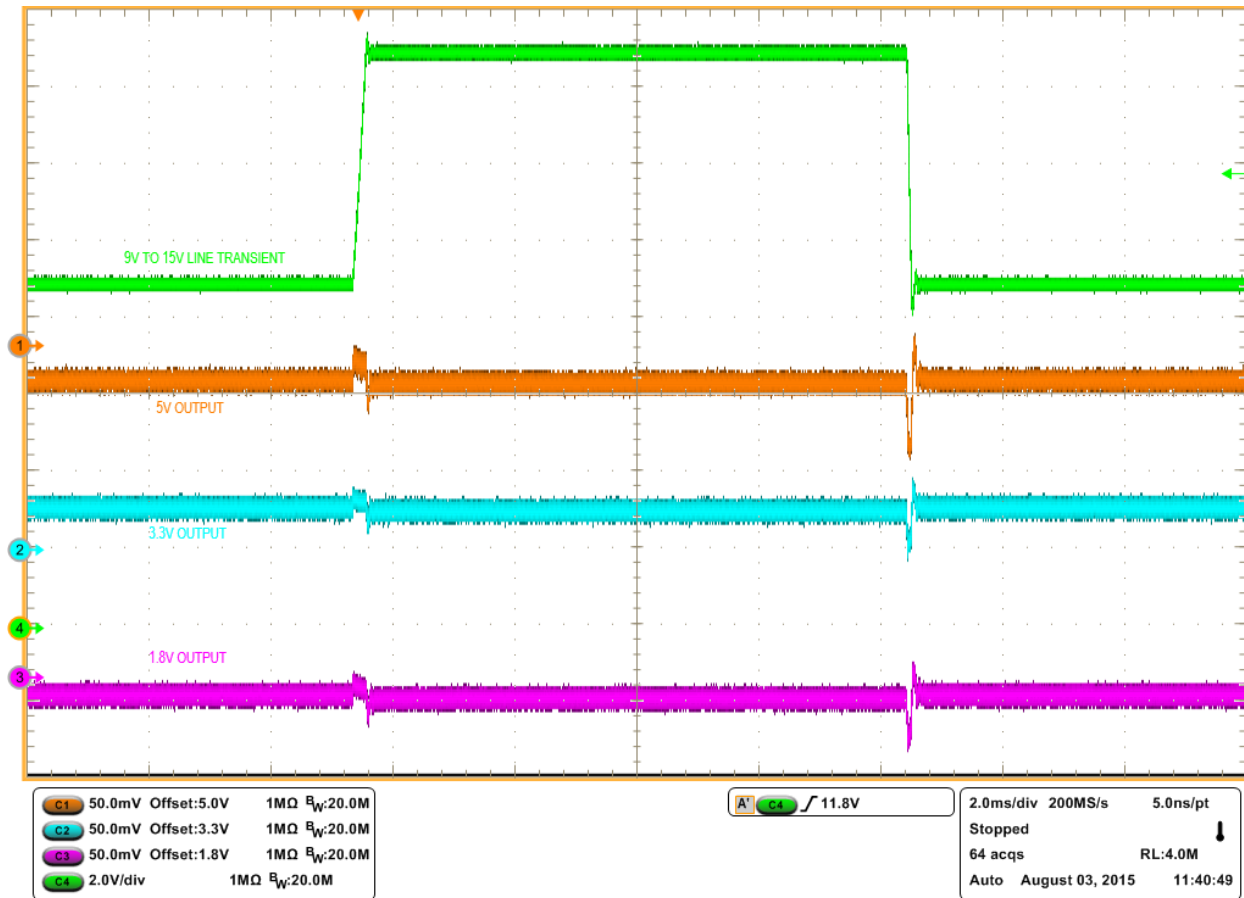

Figure 24. 9V to 15V Line Transient

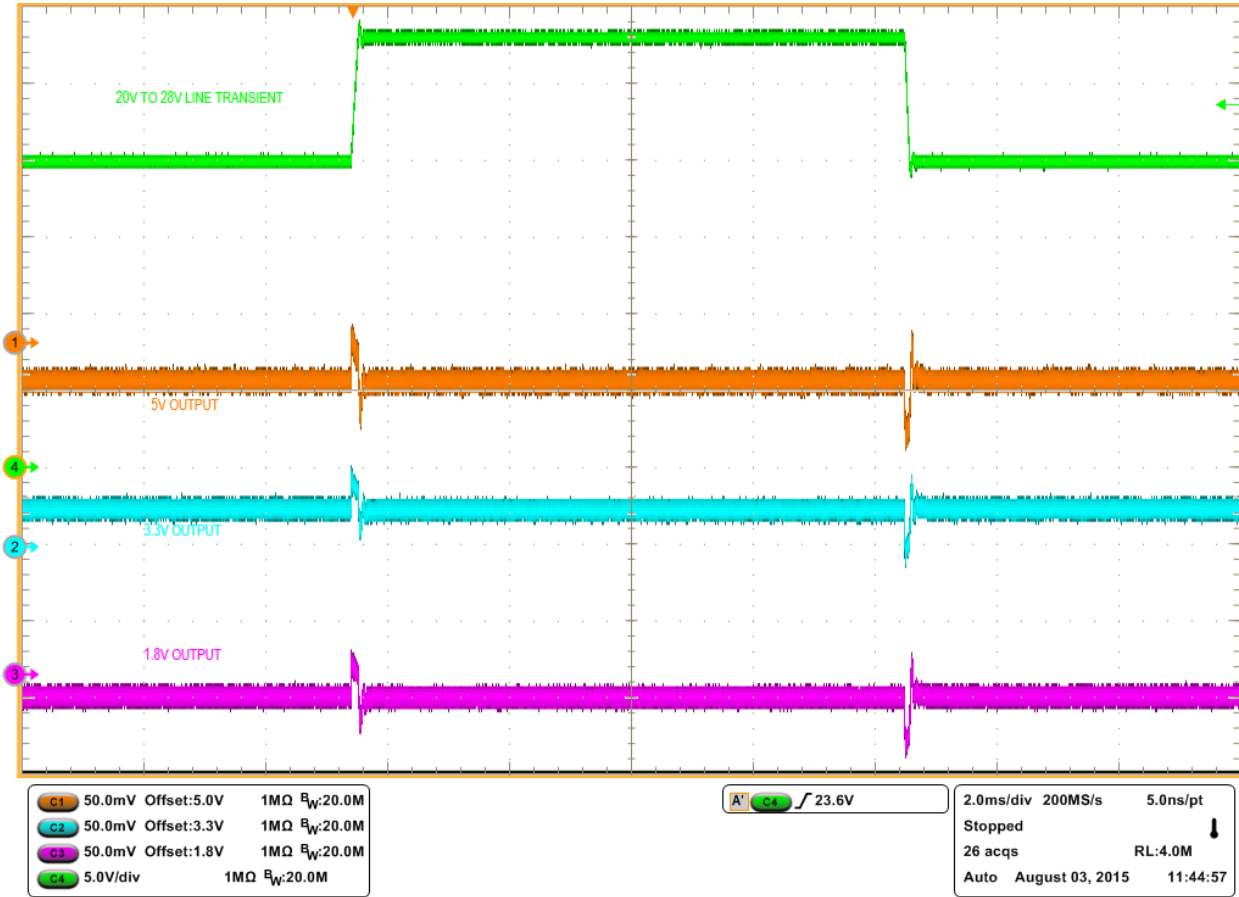

Figure 25. 20V to 28V Line Transient

Thermal Performance with Various Input Voltages and Loads

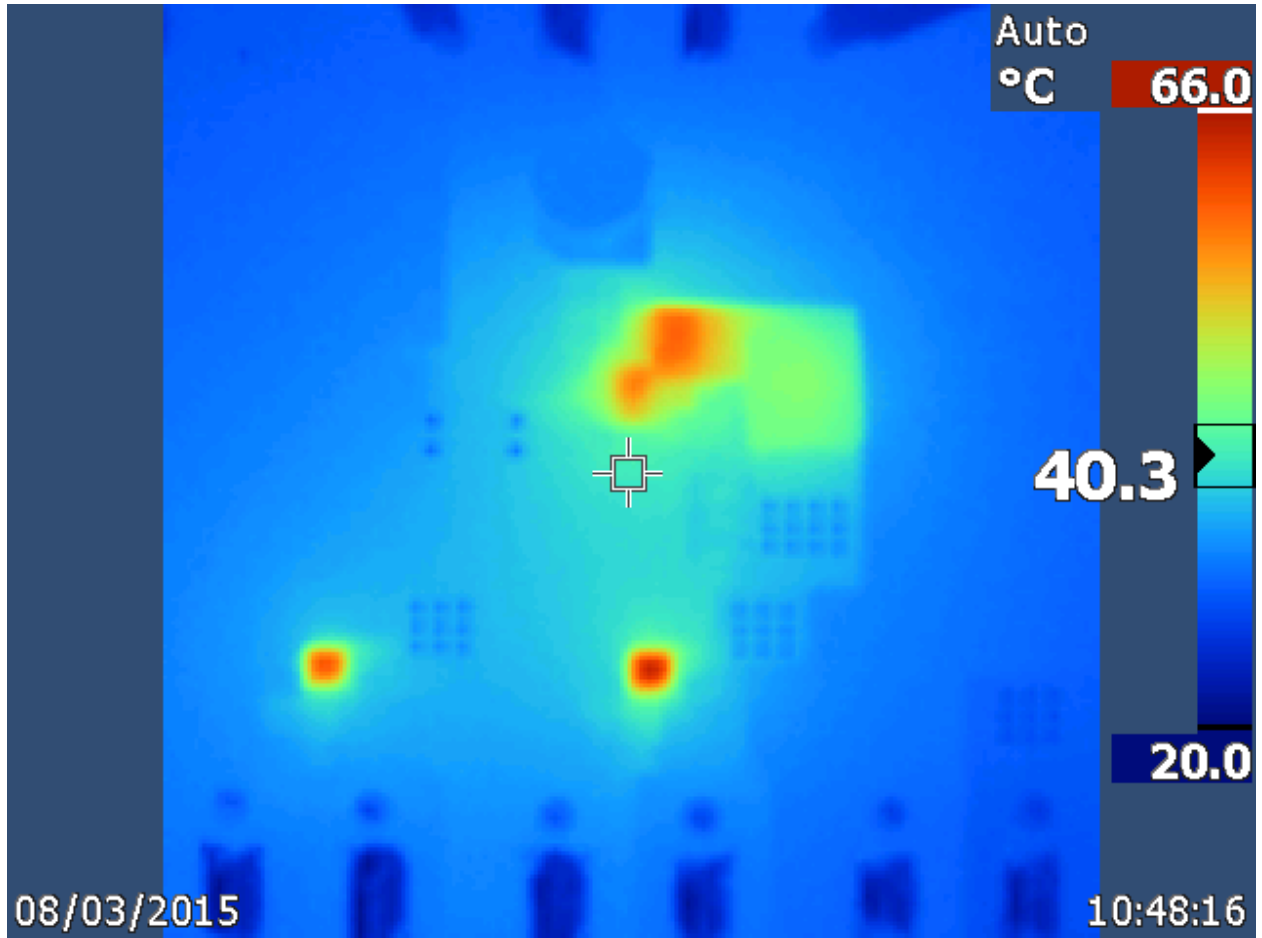

Figure 26. 24V Input, 2A on each rail (Max Load)

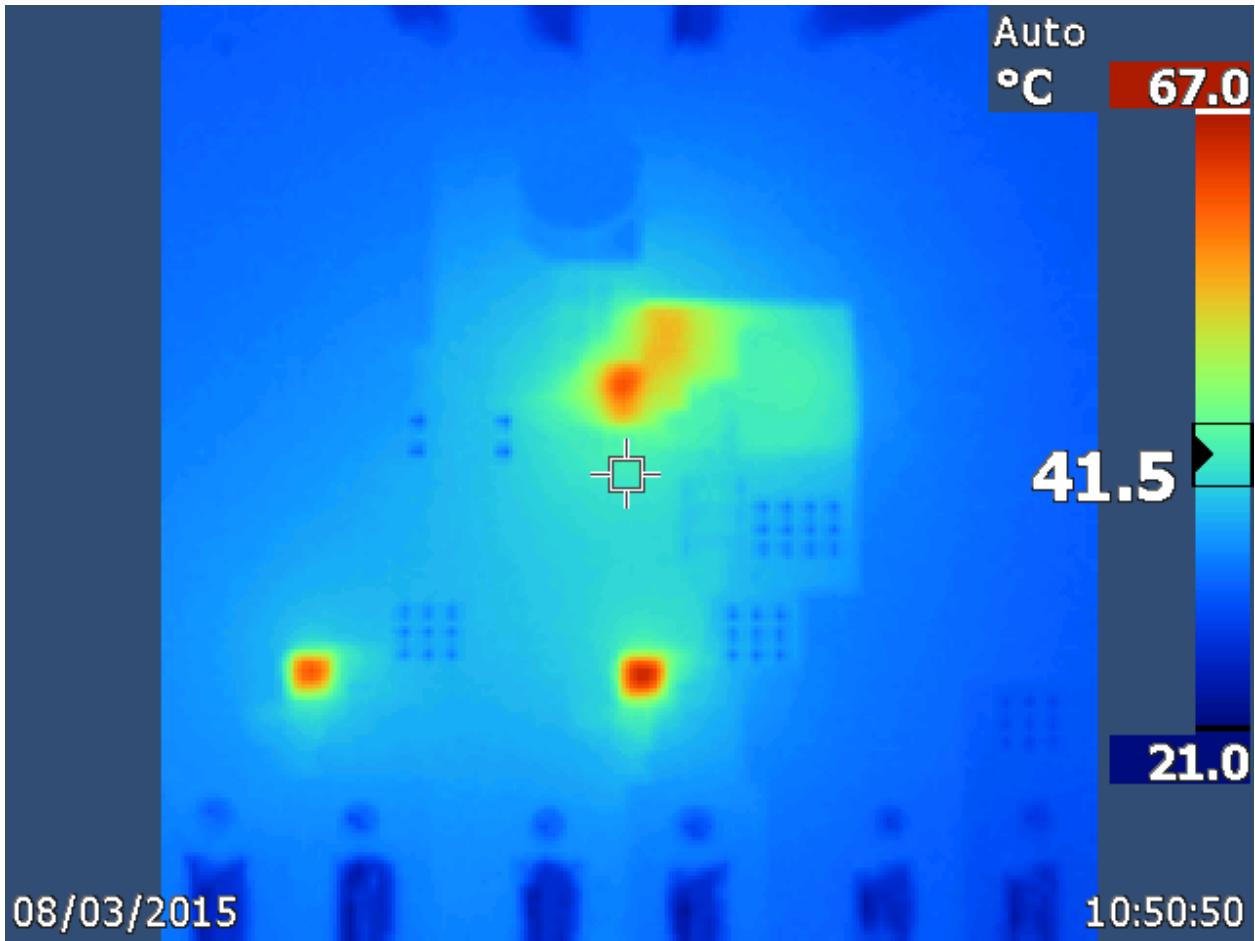

Figure 27. 12V Input, 2A on each rail (Max Load)

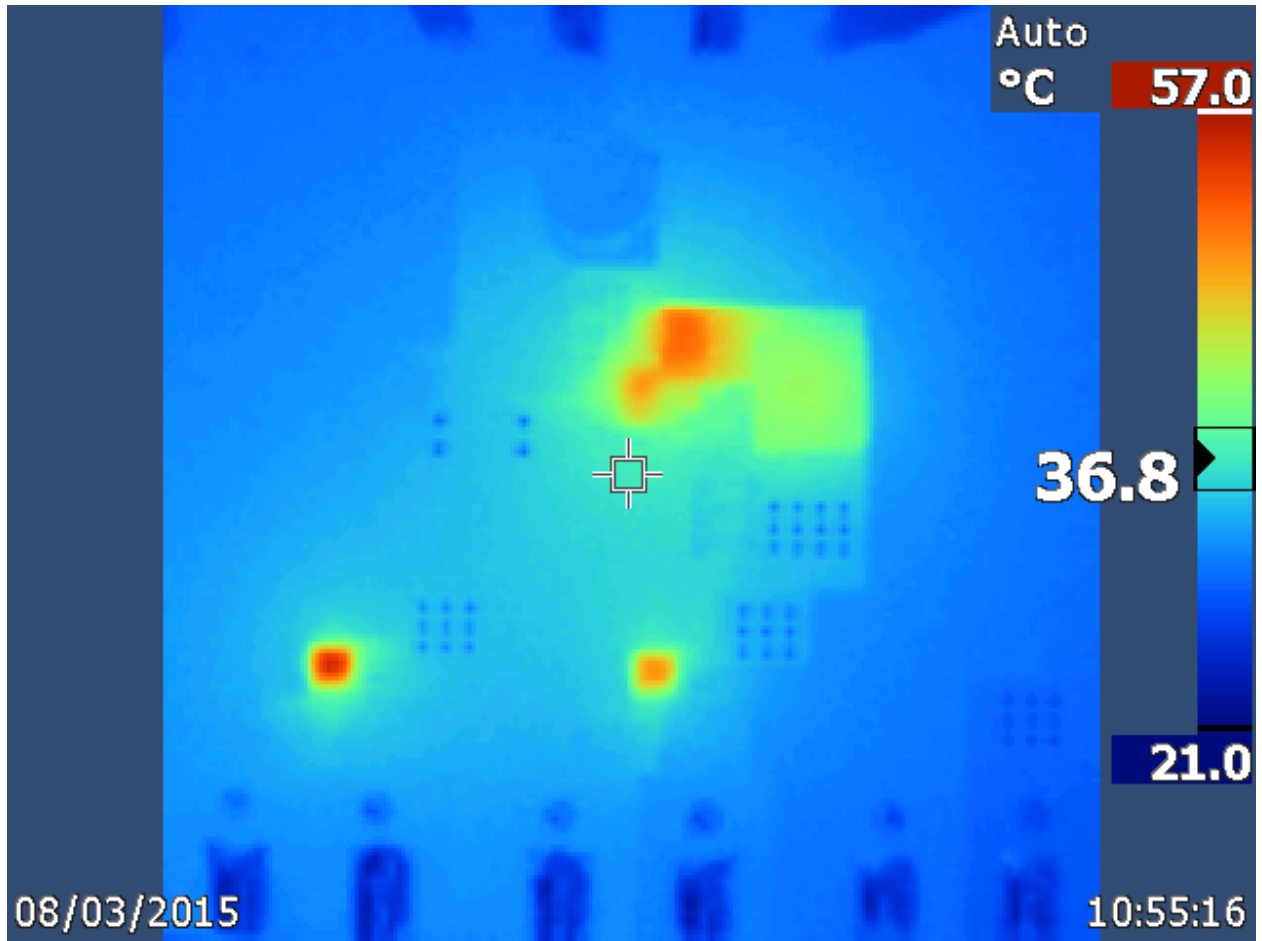

Figure 28. 24V Input, 1.5A on each rail (3/4 Load)

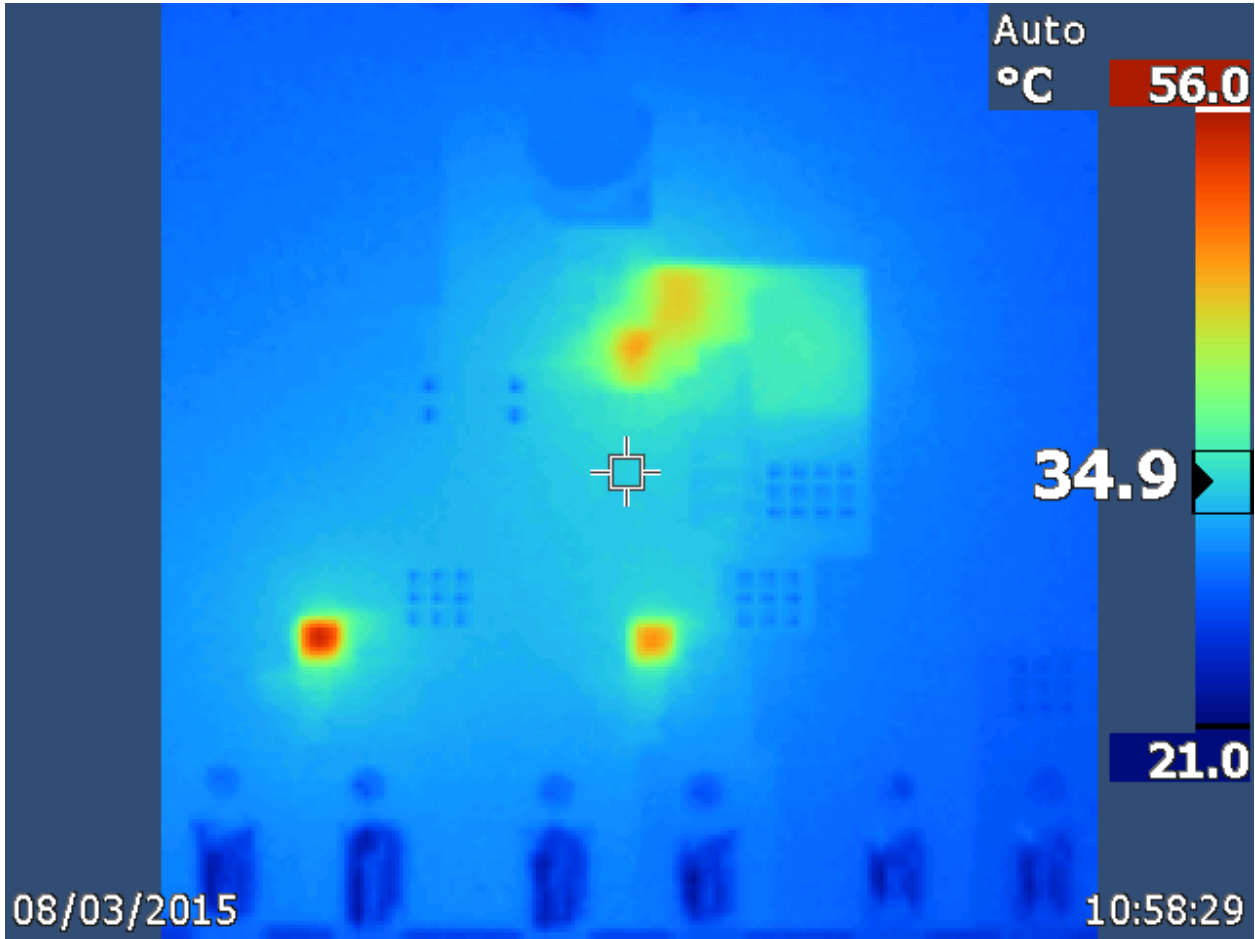

Figure 29. 12V Input, 1.5A on each rail (3/4 Load)

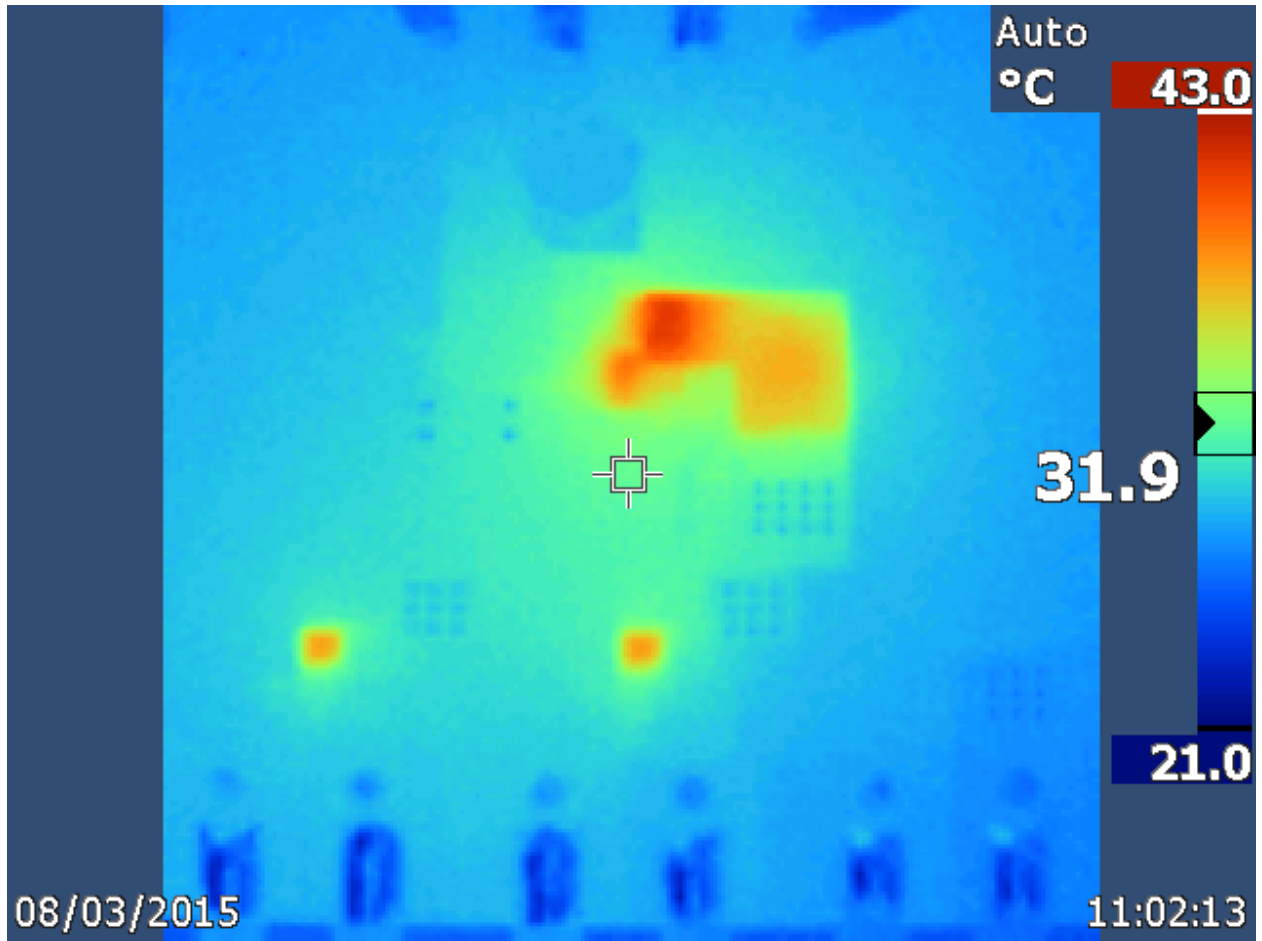

Figure 30. 24V Input, 1A on each rail (1/2 Load)

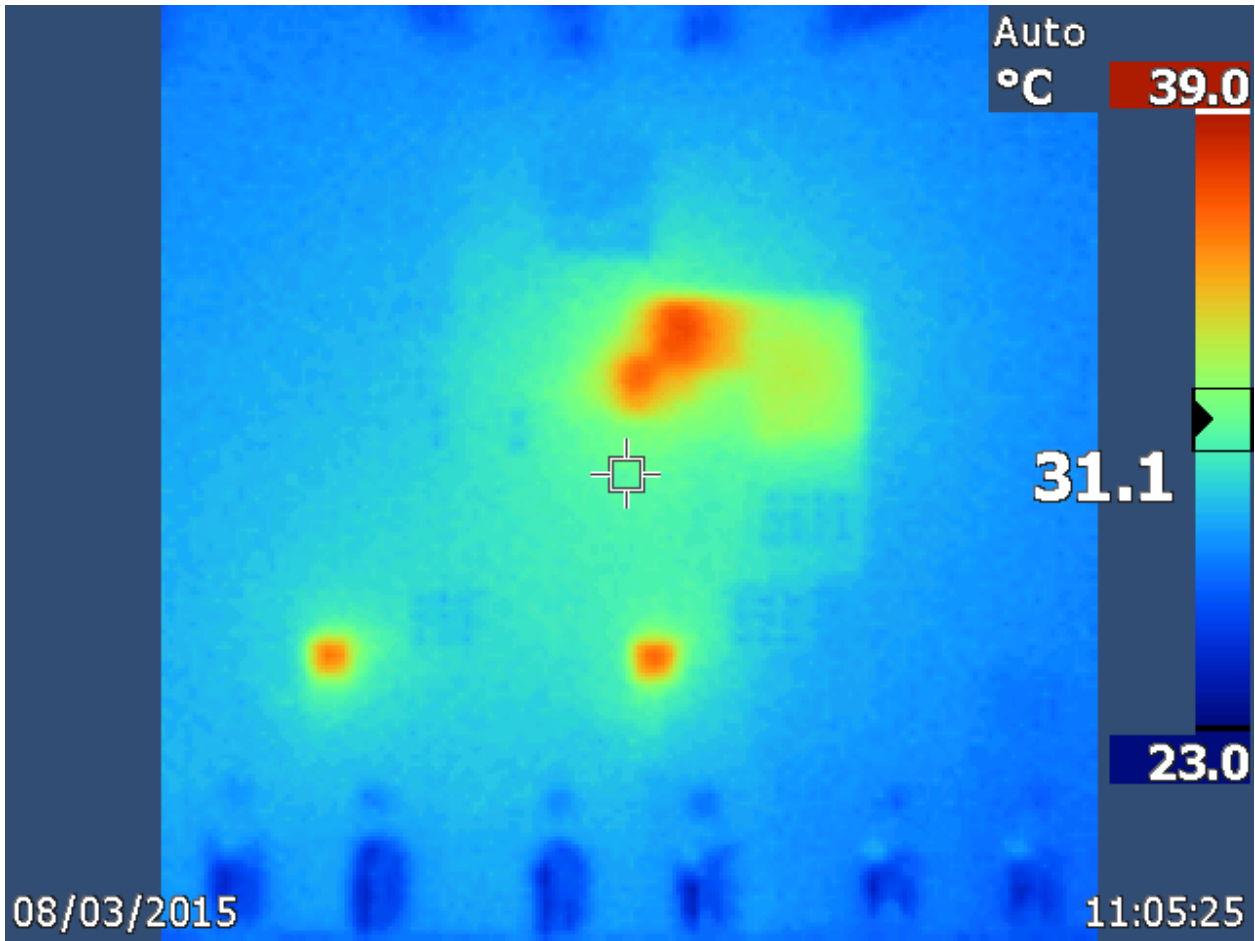

Figure 31. 12V Input, 1A on each rail (1/2 Load)

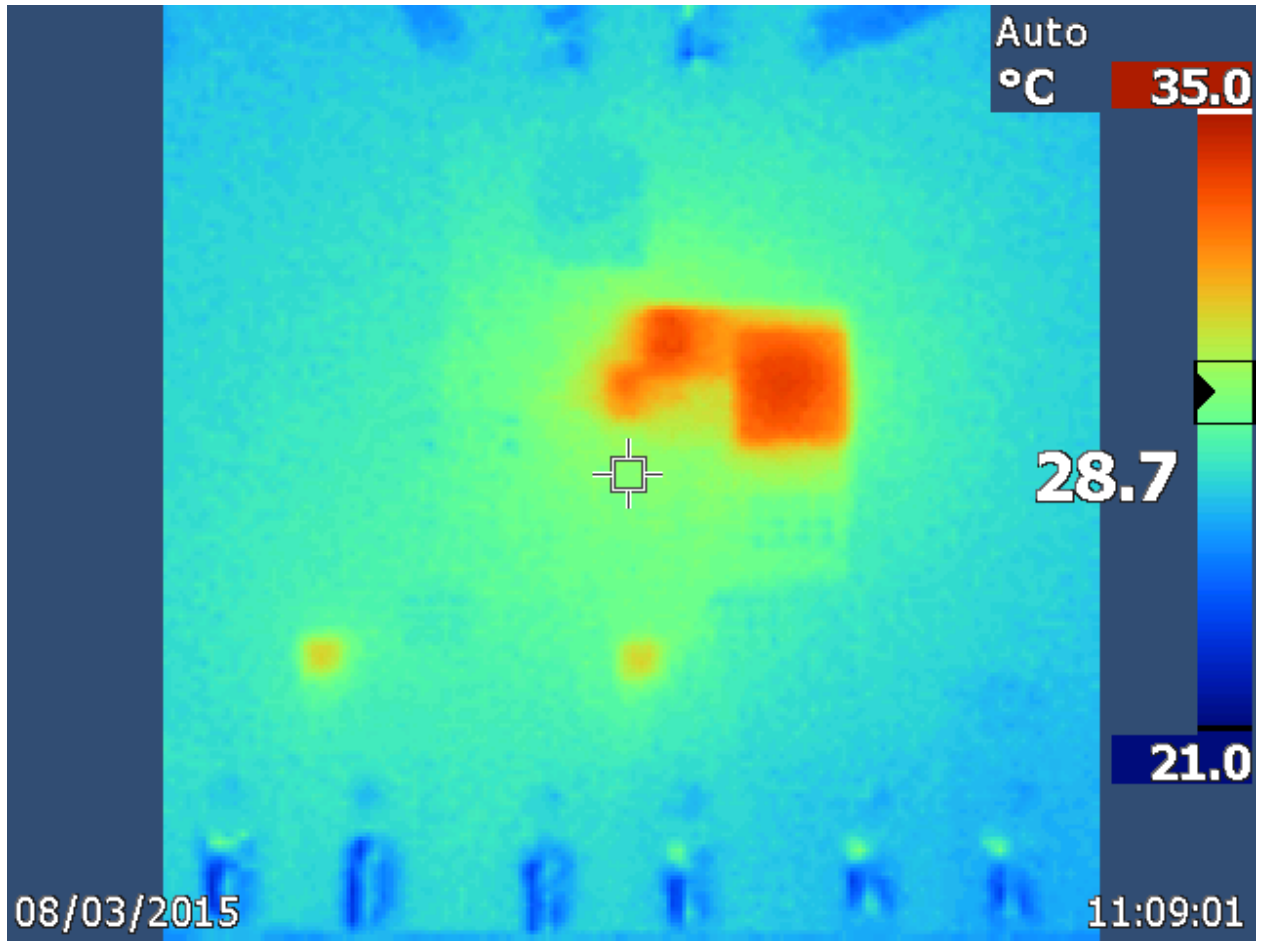

Figure 32. 24V Input, 0.5A on each rail (1/4 Load)

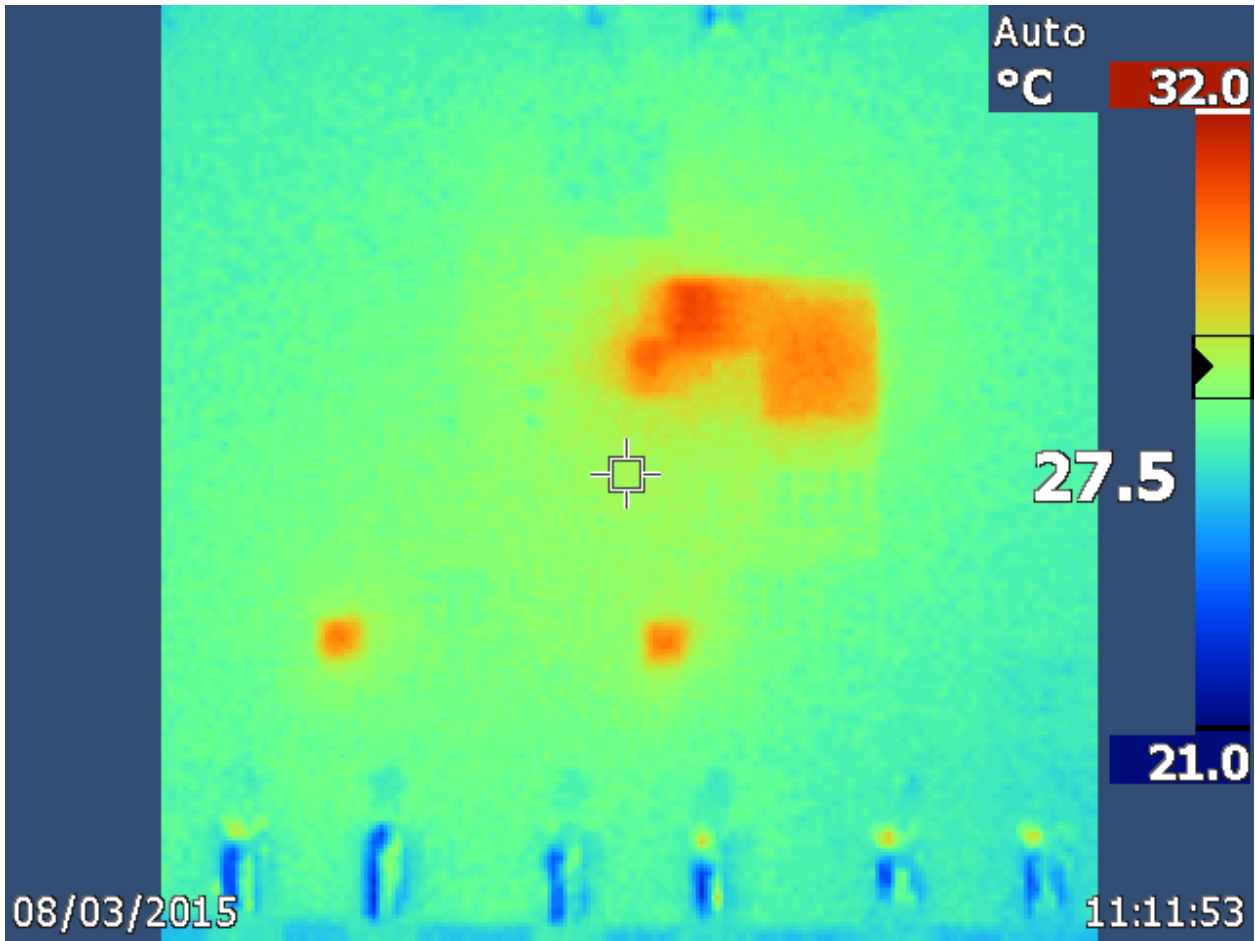

Figure 33. 12V Input, 0.5A on each rail (1/4 Load)

IMPORTANT NOTICE AND DISCLAIMER

TI PROVIDES TECHNICAL AND RELIABILITY DATA (INCLUDING DATASHEETS), DESIGN RESOURCES (INCLUDING REFERENCE DESIGNS), APPLICATION OR OTHER DESIGN ADVICE, WEB TOOLS, SAFETY INFORMATION, AND OTHER RESOURCES "AS IS" AND WITH ALL FAULTS, AND DISCLAIMS ALL WARRANTIES, EXPRESS AND IMPLIED, INCLUDING WITHOUT LIMITATION ANY IMPLIED WARRANTIES OF MERCHANTABILITY, FITNESS FOR A PARTICULAR PURPOSE OR NON-INFRINGEMENT OF THIRD PARTY INTELLECTUAL PROPERTY RIGHTS.

These resources are intended for skilled developers designing with TI products. You are solely responsible for (1) selecting the appropriate TI products for your application, (2) designing, validating and testing your application, and (3) ensuring your application meets applicable standards, and any other safety, security, or other requirements. These resources are subject to change without notice. TI grants you permission to use these resources only for development of an application that uses the TI products described in the resource. Other reproduction and display of these resources is prohibited. No license is granted to any other TI intellectual property right or to any third party intellectual property right. TI disclaims responsibility for, and you will fully indemnify TI and its representatives against, any claims, damages, costs, losses, and liabilities arising out of your use of these resources.

TI's products are provided subject to TI's Terms of Sale (<https://www.ti.com/legal/termsofsale.html>) or other applicable terms available either on [ti.com](https://www.ti.com) or provided in conjunction with such TI products. TI's provision of these resources does not expand or otherwise alter TI's applicable warranties or warranty disclaimers for TI products.

Mailing Address: Texas Instruments, Post Office Box 655303, Dallas, Texas 75265
Copyright © 2021, Texas Instruments Incorporated