



Texas Instruments

PMP4451 Test Report

Asia Power Design Service

PMP4451

1 General

1.1 **PURPOSE**

Provide the detailed data for evaluating and verifying the PMP4451.

PMP4451 is a power bank reference design within one Micro B port supporting fast charger input and two output ports. One output port is a USB type C port supporting 5V/3A output and another one is a USB type A port supporting fast charger output whose capacity is up to 5V/9V/2A or 12V/1.5A.

The valid input voltage can be up to 12V according to the charging protocol. The output voltage of type C port is fixed at 5.1V while the voltage of type A port can be 5V, 9V or 12V according to the attached device. The rated charging current of type C port is 3A and for type A port, the output current is rated at 2A when output voltage is 5V and 9V. If the output voltage increases to 12V, the output current is recommended to be limited as 1.5A.

1.2 **REFERENCE DOCUMENTATION**

PMP4451_Schematic.pdf

PMP4451_Layout.zip

PMP4451_BOM.pdf

1.3 **TEST EQUIPMENTS**

Multi-meter: FLUKE 17B

DC Source: Chroma 62024P-100-50

Electronic Load: Chroma 63106A/63030

Oscillation: Tektronix DPO3054

Infrared Thermometer: FLUKE Ti9

1.4 **PHOTOS**

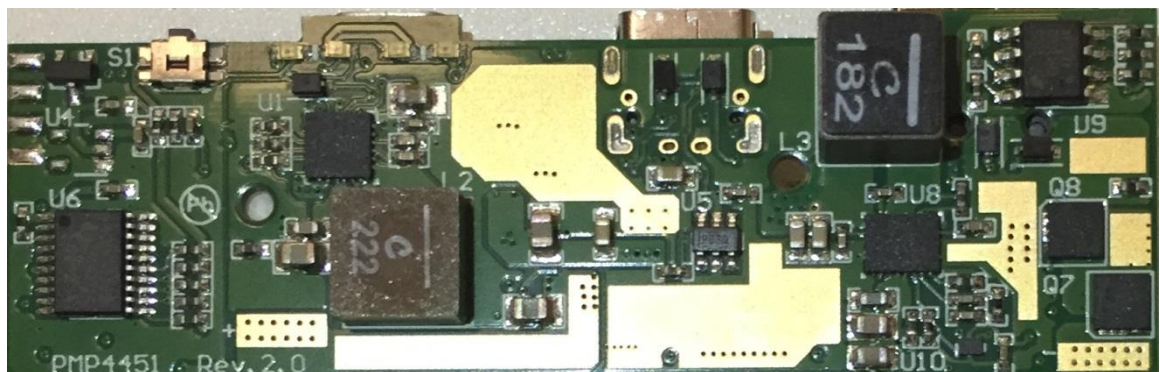

Top View

PMP4451

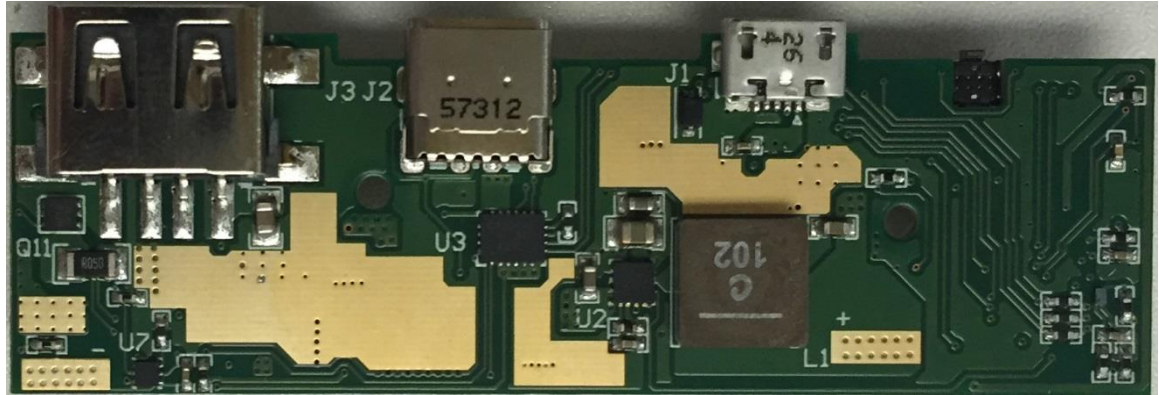

Bottom View

2 INPUT AND OUTPUT CHARACTERISTICS

2.1 STANDBY CURRENT

PARAMETER		TEST CONDITION	MIN	TYP	MAX	UNIT
I_{STD}	Standby current	V _{BAT} =3.5V, All port unattached		495		uA

2.2 EFFICIENCY

12Vin Charging & V_{BAT}=3.2V

V _{in} (V)	I _{in} (A)	V _{BAT} (V)	I _{BAT} (A)	EFF.(%)
12.017	0.0267	3.1938	0.0506	50.37%
12	0.1656	3.2024	0.4303	69.34%
12.074	0.3284	3.1937	0.9366	75.44%
12.052	0.4972	3.205	1.4541	77.77%
12.029	0.6672	3.216	1.9584	78.48%
12.006	0.8402	3.2271	2.46	78.70%
12.087	0.9861	3.1974	2.895	77.66%

12Vin Charging & V_{BAT}=3.5V

V _{in} (V)	I _{in} (A)	V _{BAT} (V)	I _{BAT} (A)	EFF.(%)
12.016	0.0267	3.5071	0.0525	57.39%
11.998	0.1665	3.496	0.435	76.13%
12.072	0.3314	3.4875	0.9478	82.62%
12.051	0.4997	3.4987	1.4644	85.08%
12.028	0.6727	3.51	1.9791	85.85%
12.006	0.8476	3.5015	2.4881	85.61%
12.086	0.9904	3.4724	2.9156	84.58%

12Vin Charging & V_{BAT}=3.8V

V _{in} (V)	I _{in} (A)	V _{BAT} (V)	I _{BAT} (A)	EFF.(%)
12.014	0.035	3.8007	0.0572	51.70%

PMP4451

11.996	0.173	3.8093	0.435	79.85%
11.973	0.3483	3.8205	0.9422	86.32%
12.046	0.529	3.8128	1.4841	88.80%
12.021	0.712	3.8241	1.9941	89.10%
11.996	0.9005	3.8356	2.5041	88.91%
12.076	1.051	3.8068	2.9475	88.41%

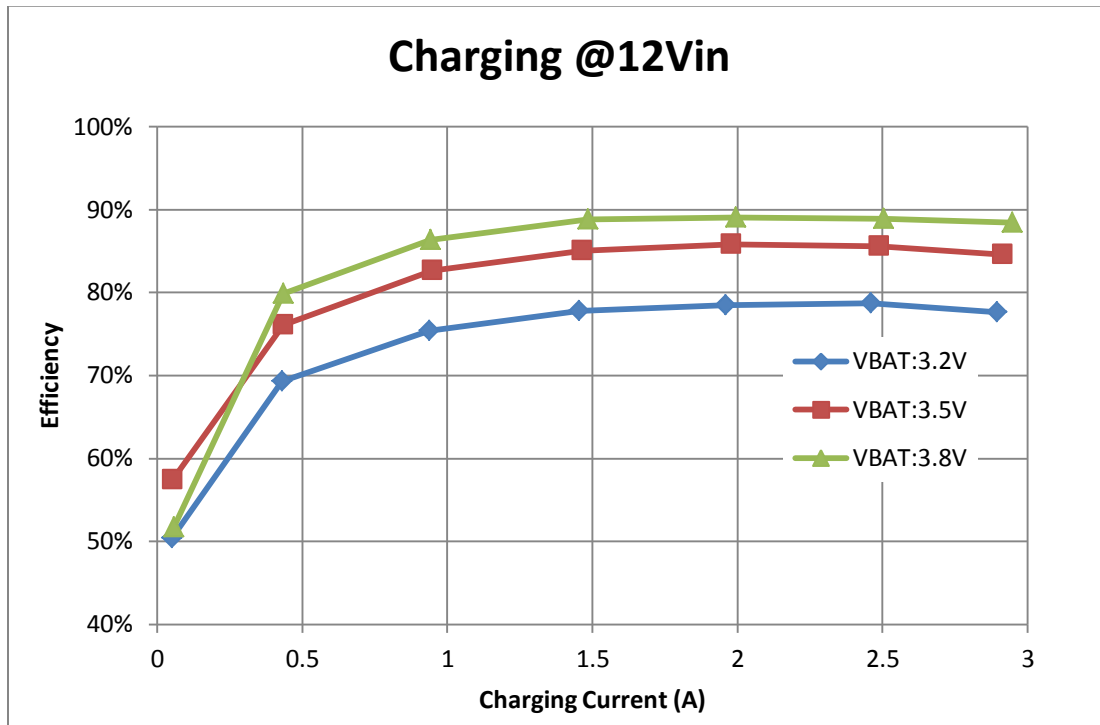

9Vin Charging & VBAT=3.2V

$V_{in}(V)$	$I_{in}(A)$	$V_{BAT}(V)$	$I_{BAT}(A)$	EFF.(%)
9.005	0.0342	3.1938	0.0506	52.47%
8.982	0.211	3.2023	0.4313	72.88%
9.067	0.4253	3.2133	0.9375	78.12%
9.038	0.6497	3.2049	1.4569	79.52%
9.009	0.8758	3.2159	1.9613	79.94%
8.979	1.1064	3.2271	2.4628	80.00%
9.054	1.2976	3.1974	2.8969	78.84%

9Vin Charging & VBAT=3.5V

$V_{in}(V)$	$I_{in}(A)$	$V_{BAT}(V)$	$I_{BAT}(A)$	EFF.(%)
9.006	0.0342	3.5072	0.0525	59.78%
8.983	0.2121	3.496	0.4359	79.98%
8.955	0.4354	3.5073	0.9506	85.51%
9.038	0.6538	3.5185	1.4681	87.42%

PMP4451

9.007	0.8821	3.51	1.98	87.47%
8.977	1.112	3.482	2.4806	86.53%
9.05	1.3043	3.4724	2.9203	85.91%

9Vin Charging & VBAT=3.8V

$V_{in}(V)$	$I_{in}(A)$	$V_{BAT}(V)$	$I_{BAT}(A)$	EFF.(%)
9.004	0.0425	3.781	0.0563	55.63%
8.982	0.2195	3.7896	0.435	83.61%
9.064	0.4457	3.8007	0.9431	88.73%
9.033	0.6912	3.8126	1.485	90.68%
9	0.936	3.824	1.9978	90.69%
8.967	1.1754	3.7966	2.505	90.23%
8.939	1.391	3.8061	2.9306	89.71%

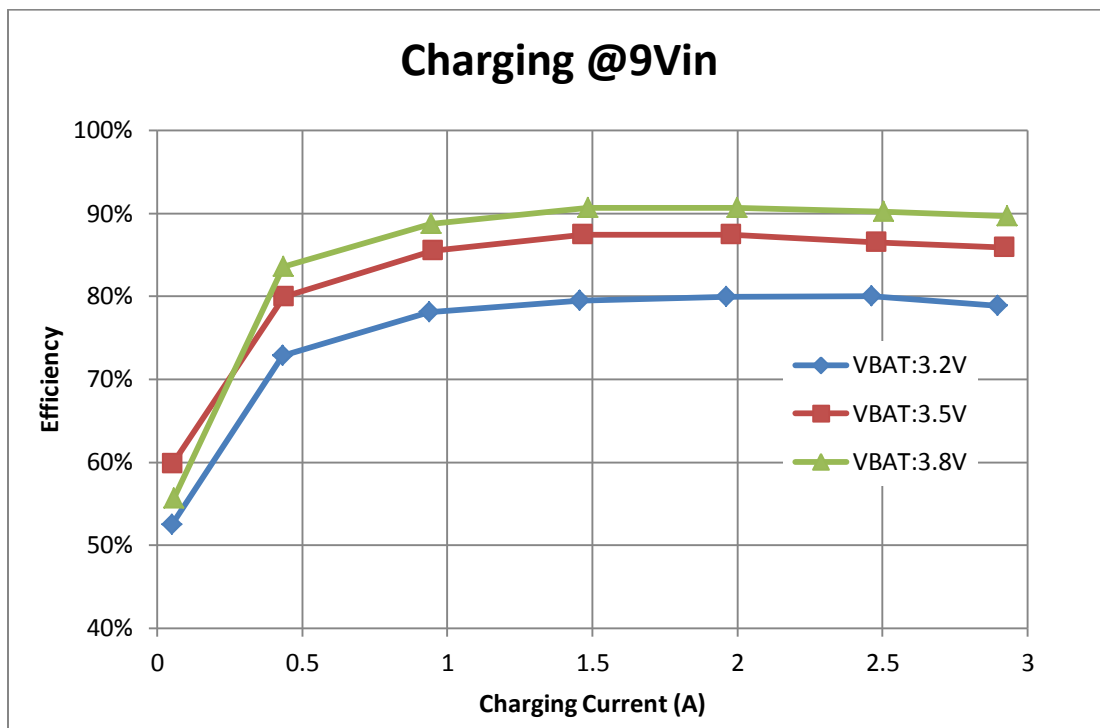

5Vin Charging & VBAT=3.2V

$V_{in}(V)$	$I_{in}(A)$	$V_{BAT}(V)$	$I_{BAT}(A)$	EFF.(%)
5.105	0.0535	3.1938	0.0506	59.17%
5.0646	0.35	3.202	0.4322	78.07%
5.0113	0.745	3.1931	0.9394	80.34%
5.0556	1.1406	3.2041	1.4578	81.00%
5.0065	1.5028	3.1952	1.9622	83.33%

5Vin Charging & VBAT=3.5V

PMP4451

$V_{in}(V)$	$I_{in}(A)$	$V_{BAT}(V)$	$I_{BAT}(A)$	EFF.(%)
5.0075	0.0542	3.4816	0.0516	66.19%
4.9691	0.358	3.4962	0.4359	85.67%
5.013	0.753	3.5075	0.9525	88.51%
4.963	1.1384	3.519	1.4756	91.91%
5.0213	1.4382	3.5277	1.8703	91.36%

5Vin Charging & VBAT=3.8V

$V_{in}(V)$	$I_{in}(A)$	$V_{BAT}(V)$	$I_{BAT}(A)$	EFF.(%)
5.104	0.06	3.781	0.0553	68.28%
5.064	0.364	3.7895	0.4359	89.61%
5.0097	0.7804	3.8007	0.9431	91.68%
4.952	1.2244	3.8123	1.47	92.43%
4.9155	1.495	3.8189	1.77	91.98%

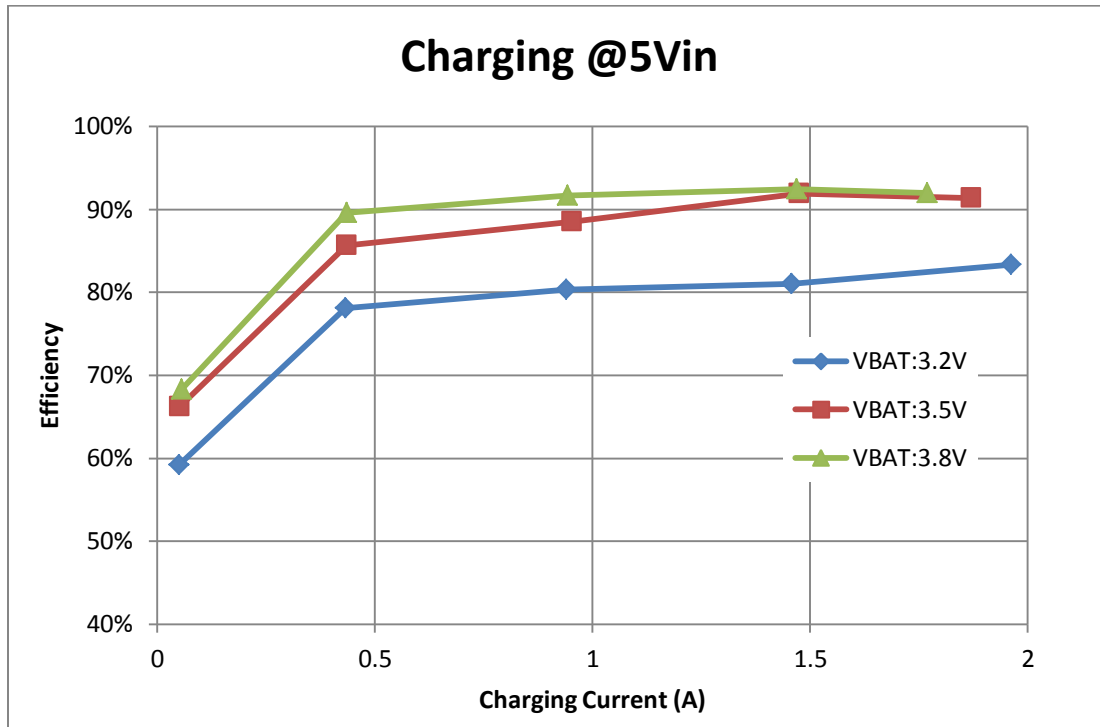

Type C DFP@ VBAT=3.2V

$V_{BAT}(V)$	$I_{BAT}(A)$	$V_o(V)$	$I_o(A)$	EFF.(%)
3.1886	0.15	5.1916	0.0881	95.63%
3.221	0.831	5.145	0.4941	94.97%
3.2523	1.6394	5.1263	0.9881	95.00%
3.2672	2.4865	5.1072	1.4972	94.12%
3.1714	3.45	5.0882	1.9931	92.69%
3.1793	4.342	5.0684	2.4872	91.32%
3.181	5.298	5.046	2.9972	89.74%

Type C DFP @ VBAT=3.5V

V _{BAT} (V)	I _{BAT} (A)	V _o (V)	I _o (A)	EFF.(%)
3.503	0.136	5.1945	0.0881	96.06%
3.5383	0.752	5.1454	0.4941	95.55%
3.561	1.486	5.127	0.9881	95.74%
3.4775	2.322	5.1077	1.4972	94.71%
3.4997	3.089	5.0891	1.9931	93.83%
3.5194	3.862	5.0694	2.4881	92.80%
3.5394	4.667	5.0486	2.9973	91.61%

Type C DFP @ VBAT=3.8V

V _{BAT} (V)	I _{BAT} (A)	V _o (V)	I _o (A)	EFF.(%)
3.798	0.125	5.1965	0.0881	96.43%
3.84	0.6895	5.146	0.4941	96.03%
3.768	1.3995	5.1273	0.9881	96.07%
3.798	2.11	5.1085	1.4972	95.44%
3.827	2.797	5.09	1.9931	94.78%
3.746	3.601	5.0707	2.4872	93.49%
3.769	4.343	5.0497	2.9972	92.46%

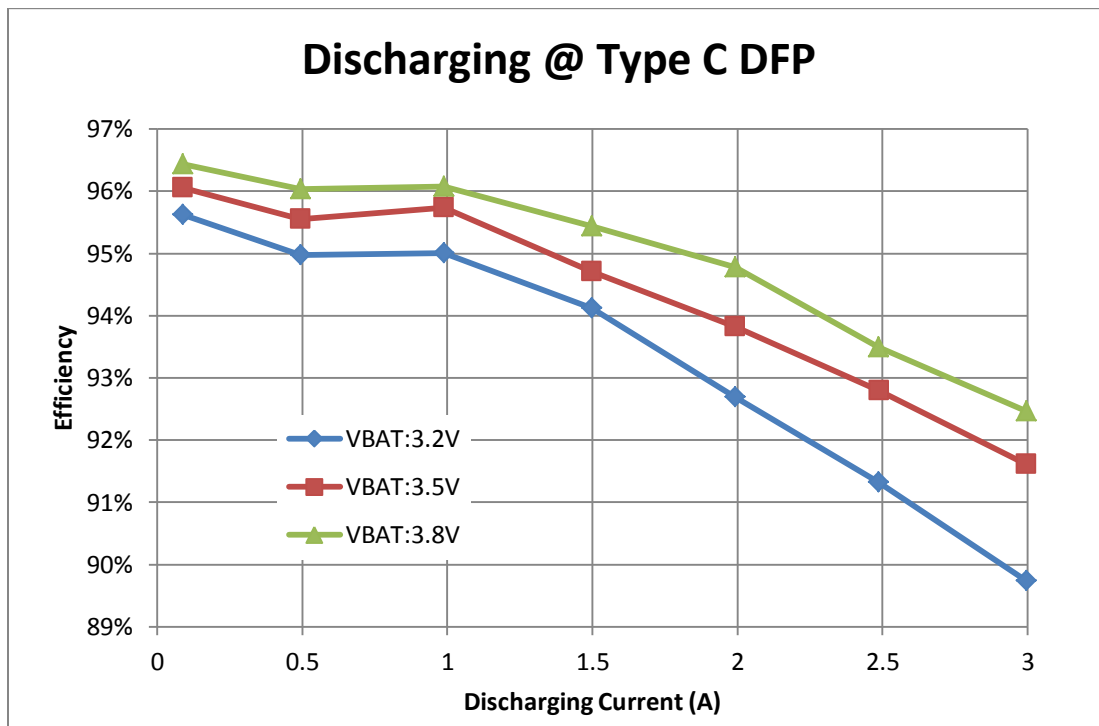

Type A Discharging @12Vo & VBAT=3.2V

V _{BAT} (V)	I _{BAT} (A)	V _o (V)	I _o (A)	EFF.(%)
----------------------	----------------------	--------------------	--------------------	---------

PMP4451

3.262	0.4196	11.948	0.0978	85.37%
3.1978	1.042	11.934	0.2488	89.11%
3.2116	2.029	11.915	0.4983	91.11%
3.2099	3.042	11.897	0.748	91.14%
3.201	4.095	11.88	0.9977	90.42%
3.186	5.204	11.863	1.2475	89.26%
3.295	6.103	11.855	1.4975	88.28%

Type A Discharging @12Vo & VBAT=3.5V

V _{BAT} (V)	I _{BAT} (A)	V _o (V)	I _o (A)	EFF.(%)
3.476	0.393	11.946	0.098	85.70%
3.52	0.936	11.933	0.2484	89.97%
3.5265	1.839	11.914	0.4981	91.51%
3.535	2.74	11.895	0.748	91.86%
3.54	3.657	11.878	0.9977	91.54%
3.546	4.592	11.861	1.2475	90.87%
3.547	5.564	11.846	1.4977	89.90%

Type A Discharging @12Vo & VBAT=3.8V

V _{BAT} (V)	I _{BAT} (A)	V _o (V)	I _o (A)	EFF.(%)
3.773	0.359	11.936	0.098	86.36%
3.8217	0.862	11.925	0.2484	89.92%
3.84	1.682	11.907	0.4983	91.86%
3.752	2.568	11.89	0.748	92.31%
3.766	3.414	11.873	0.9978	92.14%
3.776	4.277	11.857	1.2475	91.59%
3.785	5.158	11.842	1.4977	90.85%

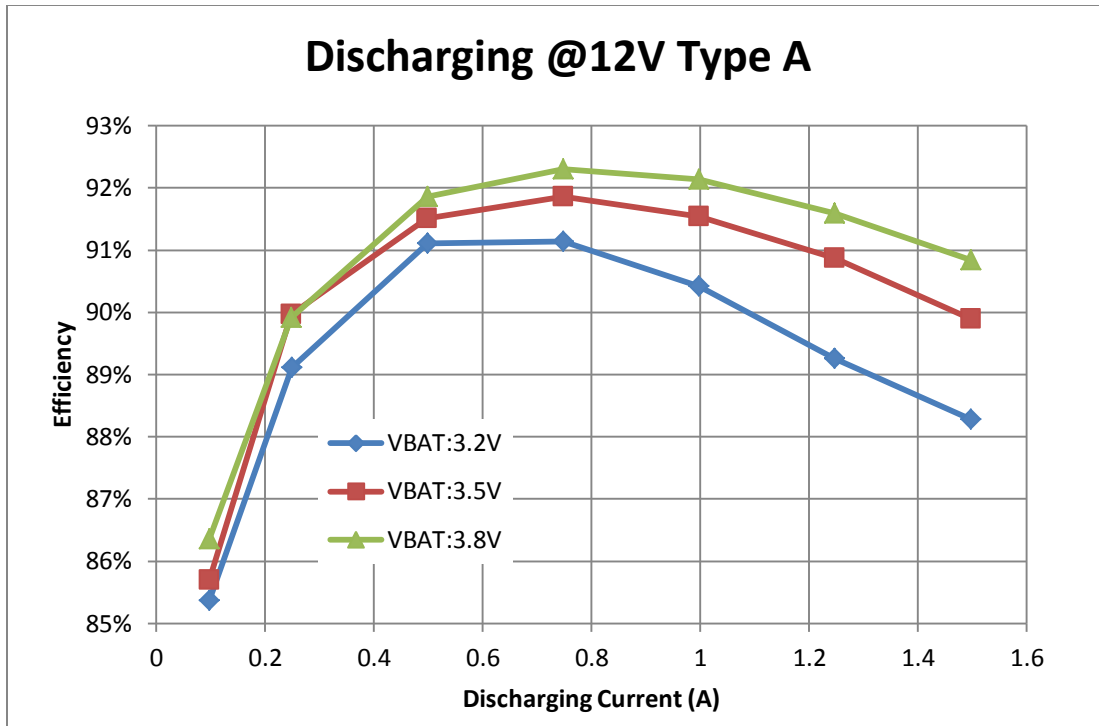

Type A Discharging @5Vo & VBAT=3.2V

V _{BAT} (V)	I _{BAT} (A)	V _o (V)	I _o (A)	EFF.(%)
3.187	0.168	5.2215	0.0978	95.38%
3.2197	0.8372	5.1475	0.4983	95.16%
3.2498	1.656	5.1061	0.9977	94.66%
3.267	2.487	5.0641	1.4975	93.33%
3.169	3.46	5.0186	1.9967	91.39%

Type A Discharging @5Vo & VBAT=3.5V

V _{BAT} (V)	I _{BAT} (A)	V _o (V)	I _o (A)	EFF.(%)
3.5	0.1525	5.225	0.0978	95.74%
3.537	0.7583	5.1476	0.4981	95.60%
3.4585	1.55	5.1062	0.9977	95.03%
3.4784	2.323	5.0641	1.4977	93.86%
3.4996	3.099	5.0212	1.9969	92.45%

Type A Discharging @5Vo & VBAT=3.8V

V _{BAT} (V)	I _{BAT} (A)	V _o (V)	I _o (A)	EFF.(%)
3.795	0.14	5.23	0.0978	96.27%
3.837	0.7	5.1814	0.4981	96.09%
3.766	1.416	5.1061	0.9975	95.51%
3.796	2.1163	5.064	1.4975	94.40%
3.824	2.815	5.0213	1.9967	93.14%

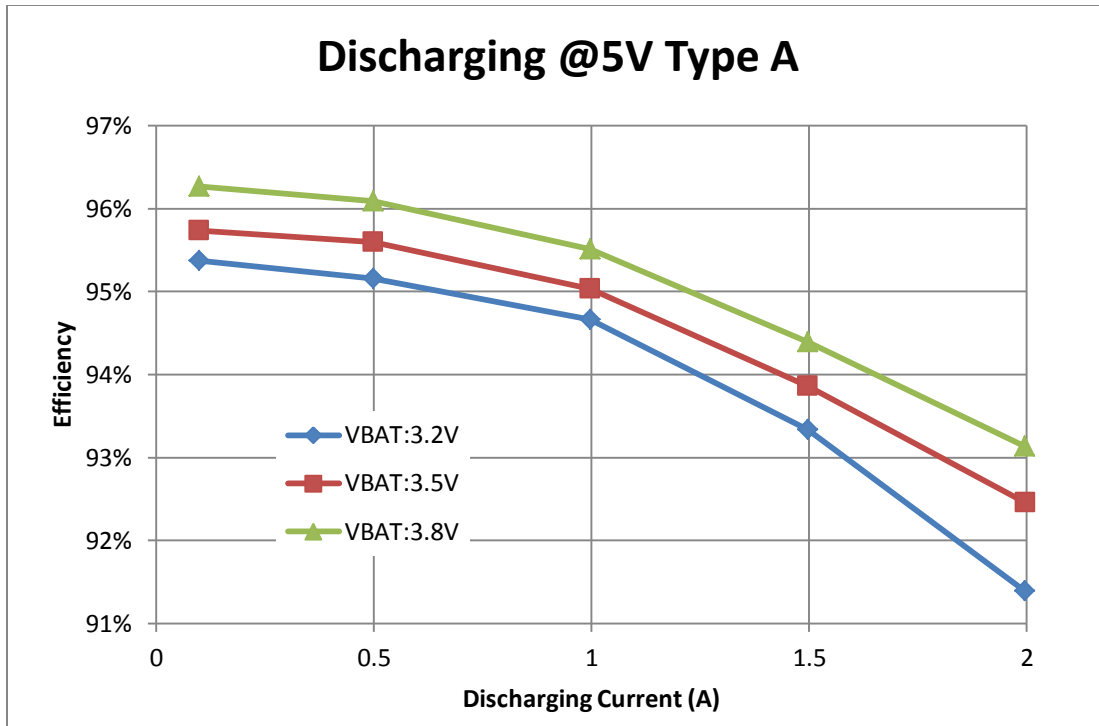

2.3 INPUT DETECTION

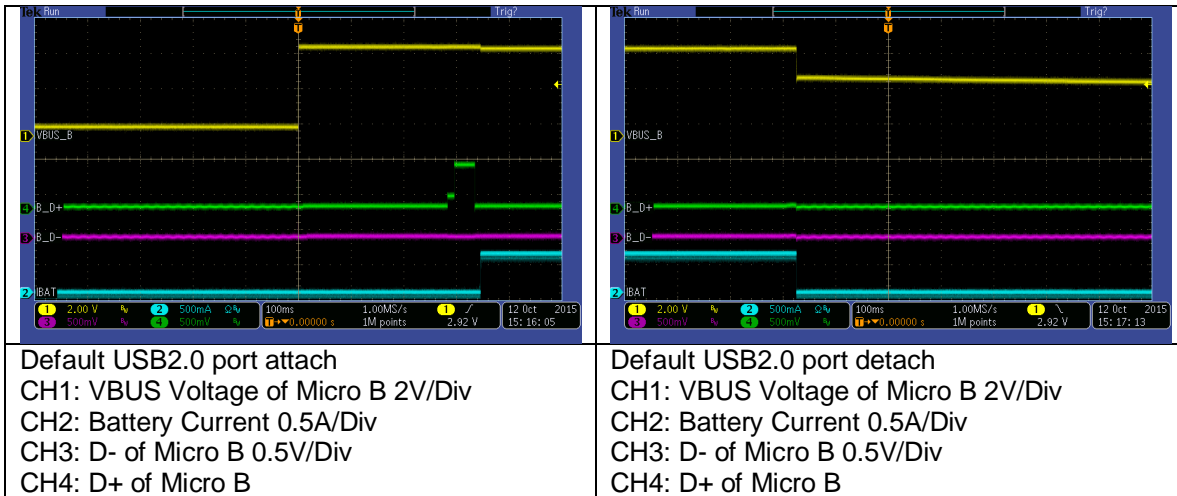

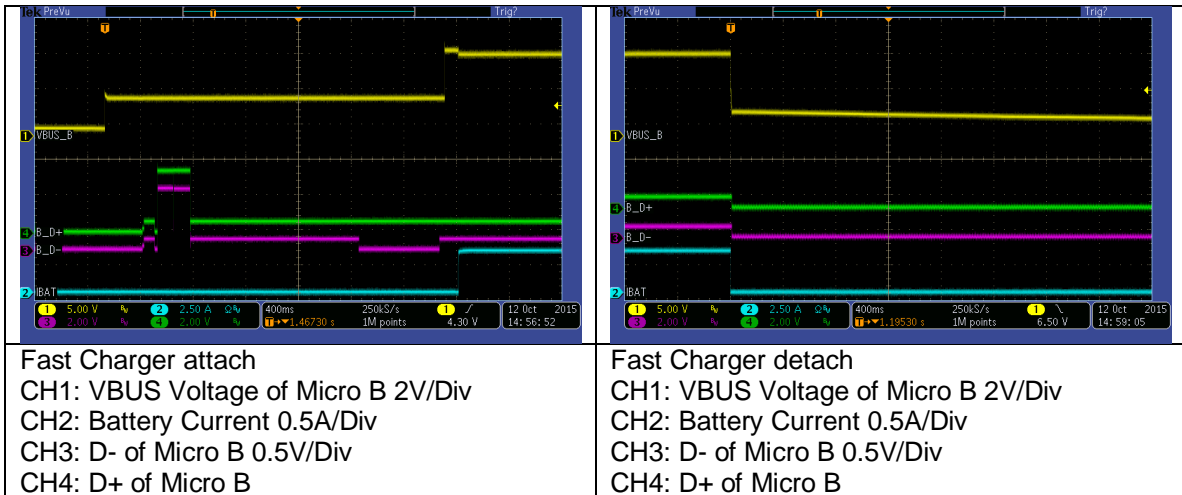

2.4 OUTPUT DETECTION

Type C to Type C Device

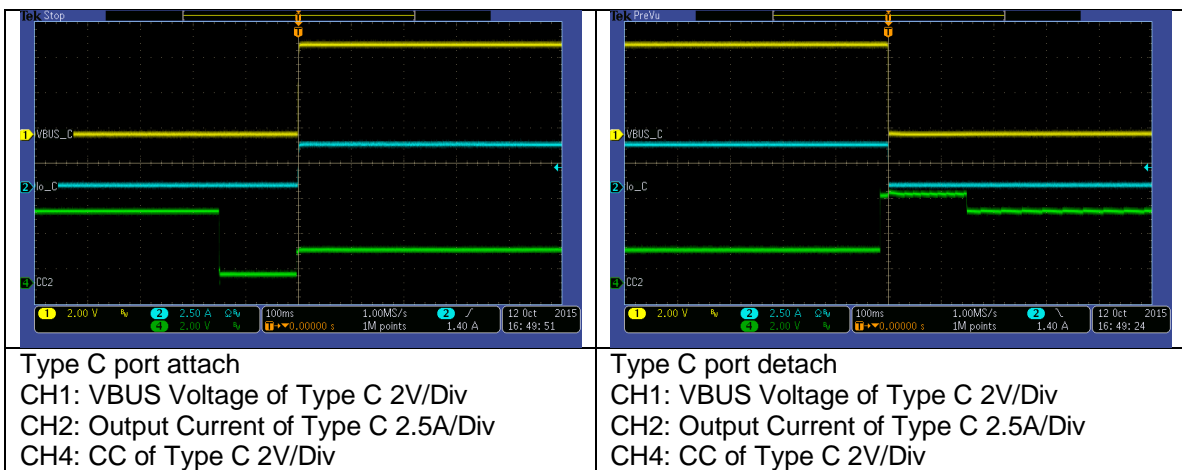

Type C to Micro B Device

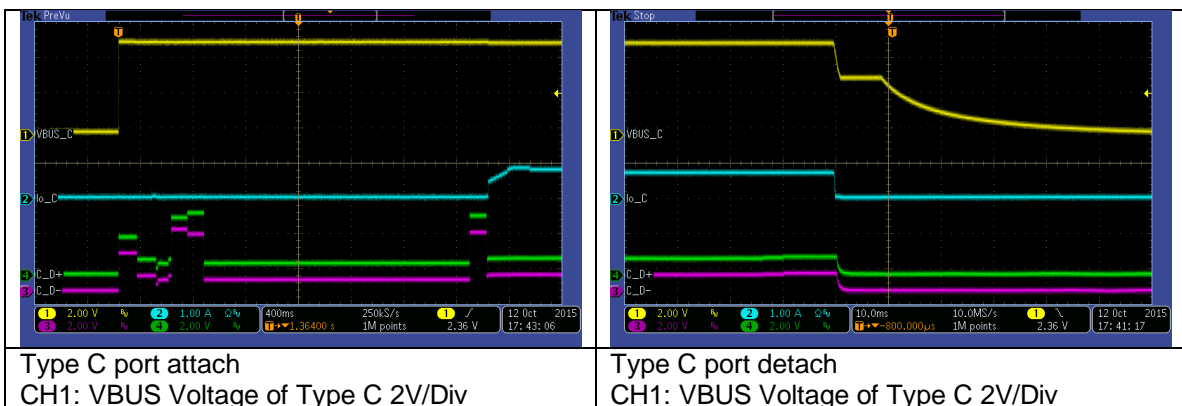

CH2: Output Current of Type C 1A/Div CH3: D- of Type C 2V/Div CH4: D+ of Type C 2V/Div	CH2: Output Current of Type C 1A/Div CH3: D- of Type C 2V/Div CH4: D+ of Type C 2V/Div
--	--

Type A to Type C Device

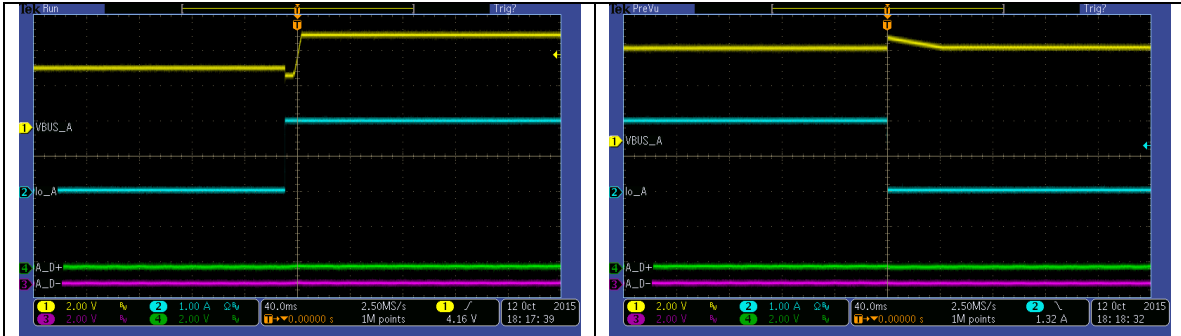

Type A port attach CH1: VBUS Voltage of Type A 2V/Div CH2: Output Current of Type A 1A/Div CH3: D- of Type A 2V/Div CH4: D+ of Type A 2V/Div	Type A port attach CH1: VBUS Voltage of Type A 2V/Div CH2: Output Current of Type A 1A/Div CH3: D- of Type A 2V/Div CH4: D+ of Type A 2V/Div
--	--

Type A to Micro B Device

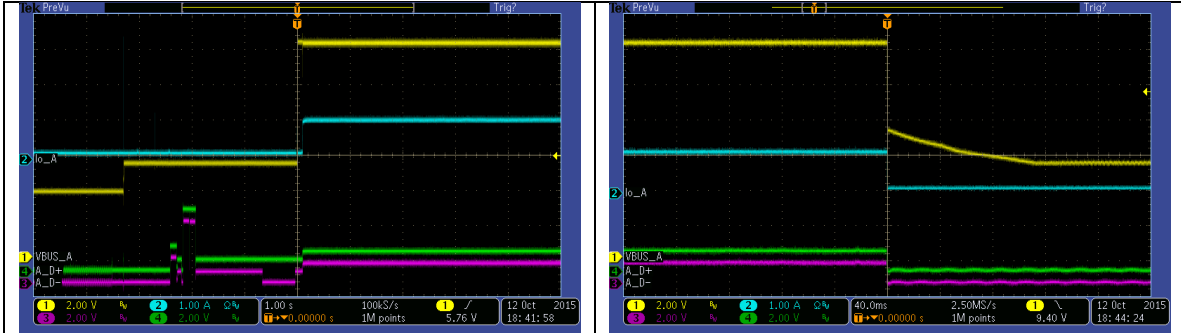

Type A port attach CH1: VBUS Voltage of Type A 2V/Div CH2: Output Current of Type A 1A/Div CH3: D- of Type A 2V/Div CH4: D+ of Type A 2V/Div	Type A port attach CH1: VBUS Voltage of Type A 2V/Div CH2: Output Current of Type A 1A/Div CH3: D- of Type A 2V/Div CH4: D+ of Type A 2V/Div
--	--

3 THERMAL

PMP4451

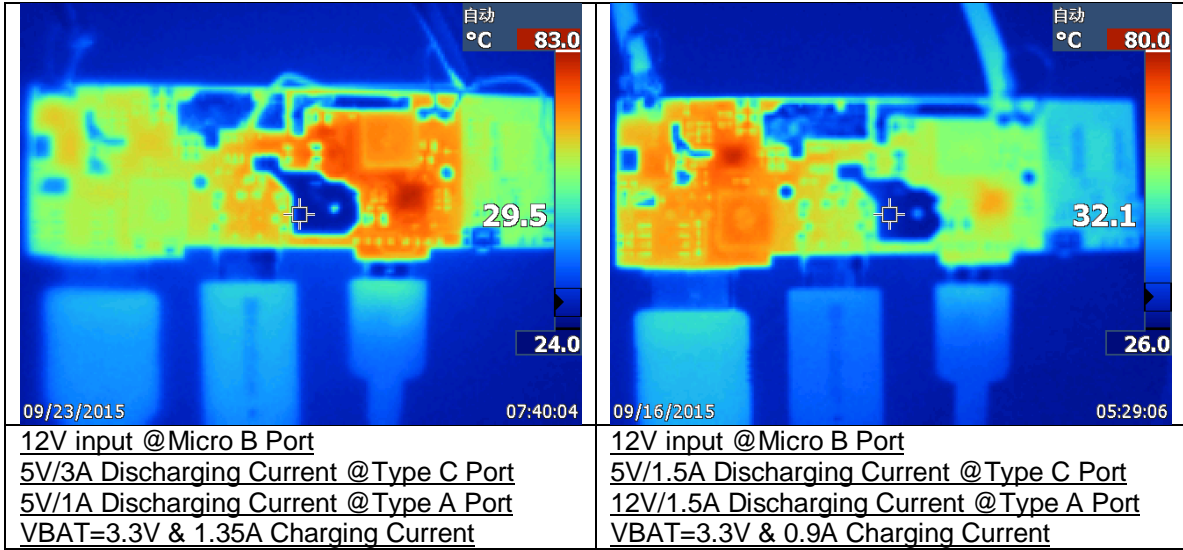

IMPORTANT NOTICE AND DISCLAIMER

TI PROVIDES TECHNICAL AND RELIABILITY DATA (INCLUDING DATASHEETS), DESIGN RESOURCES (INCLUDING REFERENCE DESIGNS), APPLICATION OR OTHER DESIGN ADVICE, WEB TOOLS, SAFETY INFORMATION, AND OTHER RESOURCES "AS IS" AND WITH ALL FAULTS, AND DISCLAIMS ALL WARRANTIES, EXPRESS AND IMPLIED, INCLUDING WITHOUT LIMITATION ANY IMPLIED WARRANTIES OF MERCHANTABILITY, FITNESS FOR A PARTICULAR PURPOSE OR NON-INFRINGEMENT OF THIRD PARTY INTELLECTUAL PROPERTY RIGHTS.

These resources are intended for skilled developers designing with TI products. You are solely responsible for (1) selecting the appropriate TI products for your application, (2) designing, validating and testing your application, and (3) ensuring your application meets applicable standards, and any other safety, security, or other requirements. These resources are subject to change without notice. TI grants you permission to use these resources only for development of an application that uses the TI products described in the resource. Other reproduction and display of these resources is prohibited. No license is granted to any other TI intellectual property right or to any third party intellectual property right. TI disclaims responsibility for, and you will fully indemnify TI and its representatives against, any claims, damages, costs, losses, and liabilities arising out of your use of these resources.

TI's products are provided subject to TI's Terms of Sale (<https://www.ti.com/legal/termsofsale.html>) or other applicable terms available either on [ti.com](https://www.ti.com) or provided in conjunction with such TI products. TI's provision of these resources does not expand or otherwise alter TI's applicable warranties or warranty disclaimers for TI products.

Mailing Address: Texas Instruments, Post Office Box 655303, Dallas, Texas 75265
Copyright © 2021, Texas Instruments Incorporated