

TI Designs: TIDEP-0069

66AK2Gx DSP + Arm® Processor Audio Processing Reference Design



TI Designs

This TI Reference Design is a reference platform based on the 66AK2Gx DSP + Arm processor and companion TLC320AIC3106 audio codec. This audio solution design also includes real-time application software using TI RTOS software that demonstrates an audio-processing block on the DSP to add audio effects. The reference design is tested and includes the K2G General Purpose Evaluation Module (GP EVM) hardware reference, and Processor SDK software.

Design Resources

TIDEP0069	Design Folder
66AK2G02	Product Folder
66AK2G12	Product Folder
TLC320AIC3106	Product Folder
K2G General Purpose EVM	EVM Tool Folder
Processor SDK for K2G	Software Folder

Features

- Programmable 3-Band Equalization
- Bass, Mid, and Treble Gain Controls
- Simple Serial User Interface
- Out-of-the-Box Testing With K2G GP EVM
- 8-kHz to 96-kHz Sample Rates
- This design is tested with the K2G General-Purpose EVM and includes design files, software, a getting started guide, and the user guide to rebuild and modify the software.

Applications

- Home Audio
- Automotive Amplifier Systems
- Soundbars
- Professional Audio
- Automated Speech Recognition (ASR) Preprocessing



[ASK Our E2E Experts](#)

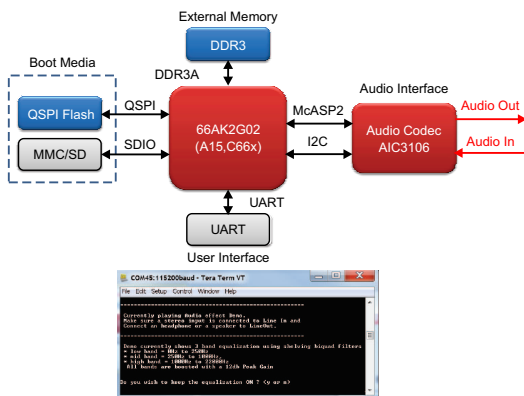

Copyright © 2016, Texas Instruments Incorporated

Figure 1. Audio Reference Design

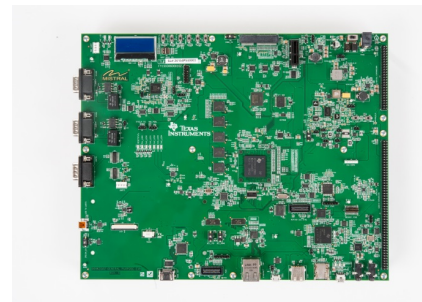

Figure 2. TI K2G General-Purpose EVM



An IMPORTANT NOTICE at the end of this TI reference design addresses authorized use, intellectual property matters and other important disclaimers and information.

1 Introduction

This TI Reference Design is a reference platform based on the 66AK2Gx DSP + Arm processor System-on-Chip (SoC) and companion AIC3106 audio codec. This audio solution design also includes real-time application software using TI RTOS software that demonstrates an audio-processing block on the DSP to add audio effects. The reference design is tested, and includes the K2G General Purpose EVM (GP EVM) hardware reference and processor SDK software. This audio reference design demonstrates the TI 66AK2Gx SoC in an audio-processing role targeted at the home audio and automotive audio application. The reference design runs on a K2G GP EVM board with a TLV320AIC3106 audio codec. This reference design demonstrates the use of the K2G SoC in a stereo audio application, and implements a 3-band audio equalizer on the C66x DSP using shelving biquad filters with adjustable gain settings. The design demonstrates a simple implementation of a digital audio equalizer which lets audio developers alter the tonal quality of audio passing through it. The developer can tune the gain applied to each of the three frequency bands over a UART-based user interface, and test the performance in a realistic environment. Furthermore, the developer can leverage the audio equalization reference design software, to prototype their own audio algorithms on the 66AK2Gx SoC or quickly adapt it as necessary to meet specific requirements of the product.

Some key features of the audio reference design follow:

- Analog input and analog output audio
- Programmable sampling rate of 8 kHz to 96 kHz
- Cascade biquad filter implementation of 3-band equalizer
- Bass, mid, and treble control using low- and high-shelf filters
- Output gain control setting from -18 dB to 18 dB
- TI RTOS-based DSP application with user interface over UART

2 System Description

Figure 3 shows a block diagram of a stereo audio application on the TI K2G General-Purpose EVM.

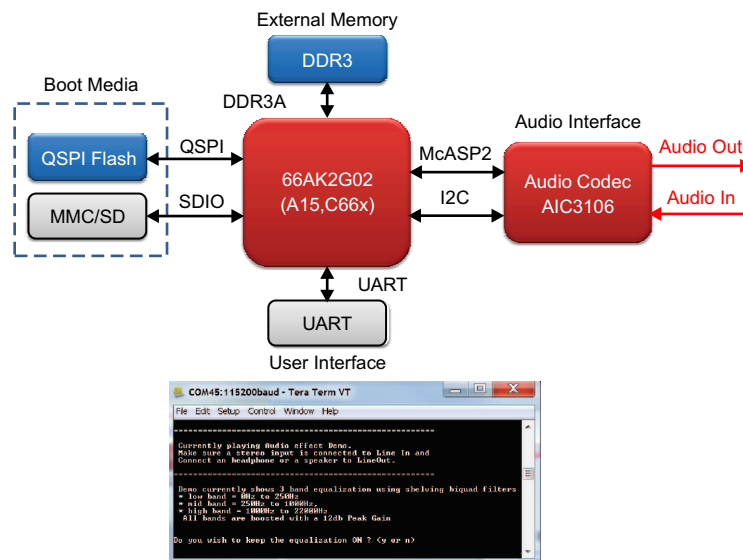

Copyright © 2016, Texas Instruments Incorporated

Figure 3. Audio Equalization Application on the K2G General-Purpose EVM

The audio equalizer is designed for use in various audio applications such as soundbars and automotive audio amplifiers. A typical design includes a speaker, headphone, and audio input source. The speaker and stereo input are connected to a TI Analog Interface Chip (TLV320AIC3106). The AIC3106 includes a microphone interface as well as a speaker amplifier, thereby eliminating the need for additional circuitry. Furthermore, the AIC3106 has integrated anti-aliasing filters. The AIC3106 is connected to the 66AK2Gx SoC through the Multichannel Audio Serial Port (McASP) as shown in [Figure 3](#). The McASP supports an Inter IC Sound (I2S) interface.

The design includes the K2G SoC plus a terminal, an audio source, speakers, and headphones. The K2G GP EVM-based demonstration uses a PC to provide the terminal and audio source. The PC is connected to the SoC through a USB-Serial interface on the K2G GP EVM. On the EVM, 2GB DDR3 is connected to the K2G SoC DDR interface, and provides external RAM for the application. The audio equalizer application is booted on the SoC using either the S25FL512 flash device connected to the Quad SPI, or the SD/MMC card using the SDIO interface on the chip.

The Cortex-A15 on the K2G SoC can also be used as the user control interface, where the designer can use inter-processor communication (IPC) to pass control messages to the equalizer. This integration afforded by the K2G SoC reduces cost, saves board space, and allows for sharing of external memory and MSMC between the C66x and A15.

3 Block Diagram

Figure 4 shows a block diagram of the 66AK2G12 DSP + Arm Processor.

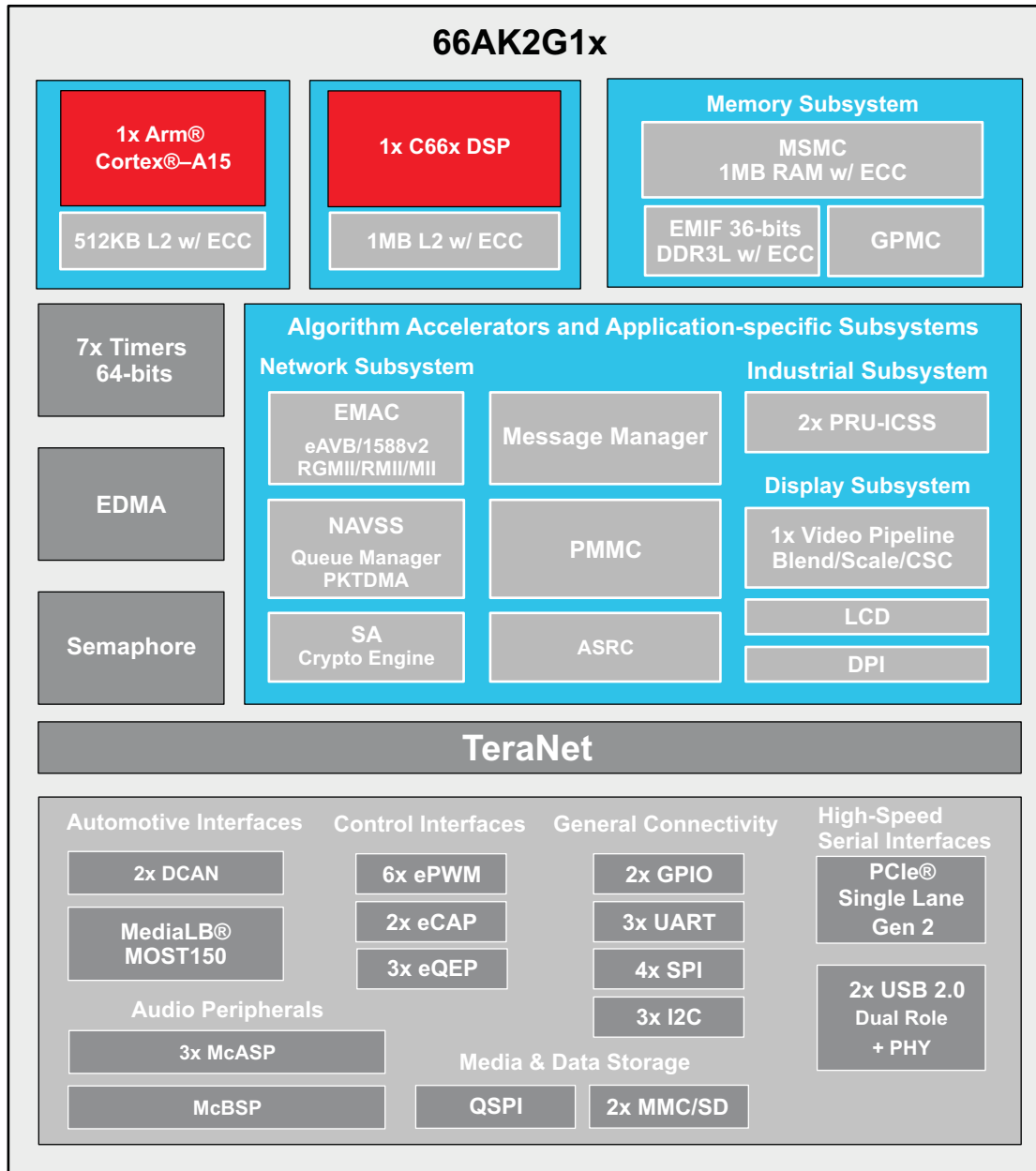

intro_001

Copyright © 2016, Texas Instruments Incorporated

Figure 4. 66AK2G12 DSP + Arm System on Chip

3.1 Highlighted Products

The TI Audio Equalizer design is based on the TI 66AK2Gx DSP+Arm System on Chip (SoC) and its associated peripherals. The 66AK2Gx SoC is a high-performance, highly integrated device based on TI KeyStone II Multicore SoC architecture. The 66AK2Gx incorporates the performance-optimized Arm Cortex®-A15 and a C66x DSP core, built to meet the processing and system-level integration needs of automotive audio, performance audio applications, and industrial communications and control.

The following 66AK2Gx features are highlighted in the TI Design:

DSP Subsystem

The C66x DSP subsystem provides the following main features:

- Fixed or floating-point C66x CPU based on a superset of the C64x+ and C67x+ ISA
- 32-KiB L1D and 32-KiB L1P cache
- 1024-KiB local L2 configurable as cache or addressable SRAM
- 1024-KiB shared L2 MSMC SRAM
- Extended Memory Controller (XMC)
- Address extension unit to 36-bit address
- Memory protections for multiple segments, and for internal L1 and L2 RAM
- Error detection for L1P
- Error detection and correction for L1D, and for L2
- Integrated interrupt controller
- Support for one integrated general-purpose timer, and one device-level watchdog timer
- Debug and trace features

Audio Peripherals

Three McASP function as general-purpose audio serial ports optimized for the needs of multichannel audio applications.

The McASP has the following features:

- Transmit or receive clocks up to 50 MHz
- Two independent clock zones and independent transmit or receive clocks per McASP
- Up to 16-, 10-, or 6-serial data pins McASP0, McASP1, and McASP2, respectively
- Supports time-division multiplexed (TDM), I2S, and similar formats
- Supports DIT mode
- Built-in FIFO buffers for optimized system

General Connectivity

- Three Inter-Integrated Circuit (I²C) interfaces, each supports:
 - Standard mode (up to 100 kHz) and fast mode (up to 400 kHz)
 - 7-bit addressing mode
 - Supports EEPROM size up to 4 Mbit
- Three UART interfaces:
 - All UARTs are 16C750-compatible and operate at up to 3M baud
 - UART0 supports eight pins with full modem control, with DSR, DTR, DCD, and RI signals
 - UART1 and UART2 are 4-pin interfaces

For more information on the 66AK2Gx SoC, including data sheets, silicon errata, and technical reference manuals, see [66AK2G12](#) product page.

4 System Overview

The TI Design demonstrates an audio-loopback scenario with an audio-processing block implemented on the 66AK2Gx DSP. This TI Design demonstrates an implementation of a digital audio-processing block that can be used to enhance or add effect to the original audio. As a sample audio-processing block, the TI Design implements a 3-band audio equalizer using biquad shelving filters with adjustable gains. An audio equalizer is an audio-processing block that lets sound engineers boost or attenuate the volume of specific frequencies within the original audio. During sound mixing, equalization is used to correct problems that may have been built into the audio during the recording, or to tune compatibility among musical instruments. Equalization is also used to produce original effects, or desired responses on a speaker or headphone.

4.1 Audio Input and Output

The TI Design is set up to receive the audio samples received on the 66AK2Gx McASP port through the AIC3106 codec, and plays back the processed audio samples through the audio output port of the K2G GP EVM.

4.1.1 AIC3106 Audio Codec

The AIC3106 audio codec on the TI K2G GP EVM acts as the front end that converts analog audio signals to digital audio samples in the required format. The AIC3106 contains stereo audio digital-to-analog converter (DAC) and analog-to-digital converter (ADC) that support sampling frequencies from 8 kHz to 96 kHz with a high signal-to-noise ratio. The AIC3106 audio codec has an audio serial data bus that supports I2S, left- and right-justified, DSP, and TDM modes with 16-, 20-, 24-, and 32-bit output data formats. The 66AK2Gx SoC on the EVM is connected to the AIC3106 over an I²C interface used to configure the audio codec to provide input audio in either 16- or 32-bit format required by the biquad block on the C66x DSP. The sampling rate is set to 44.1 kHz.

4.1.2 66AK2Gx McASP Configuration

The 66AK2Gx digital audio input and output is provided by the McASP interface, which is a general-purpose serial port. The McASP supports TDM stream, I2S protocols, direct connection to ADCs and DACs. The McASP includes independent transmit and receive sections with separate master clocks, bit clocks, and frame syncs. Up to sixteen serializers can be individually enabled for either transmit or receive operation. The number of serializers supported on each McASP varies between devices. For more information, see the *TMS320DM645 Video/Imaging Fixed-Point Digital Signal Processor Data Manual* (SPRS392). Each McASP also includes a 256-byte read FIFO and write FIFO.

The McASP on the 66AK2Gx is configured in clock master mode, with the input and output serializers configured for TDM format, to read in the left and the right channel data in either 16- or 32-bit format. The transmit and receive clocks, as well as the frame sync, are configured to generate using internal clocks. The EDMA3 controller is programmed to move input data from McASP FIFO to internal buffers on the receive side, and from the internal L2 memory to McASP FIFO on the transmit side. The McASP generates transmit and receive DMA event (AXEVT or AREVT) requests when data is to be transferred to and from its serializer registers. The EDMA must service McASP FIFOs when AXEVT or AREVT are generated.

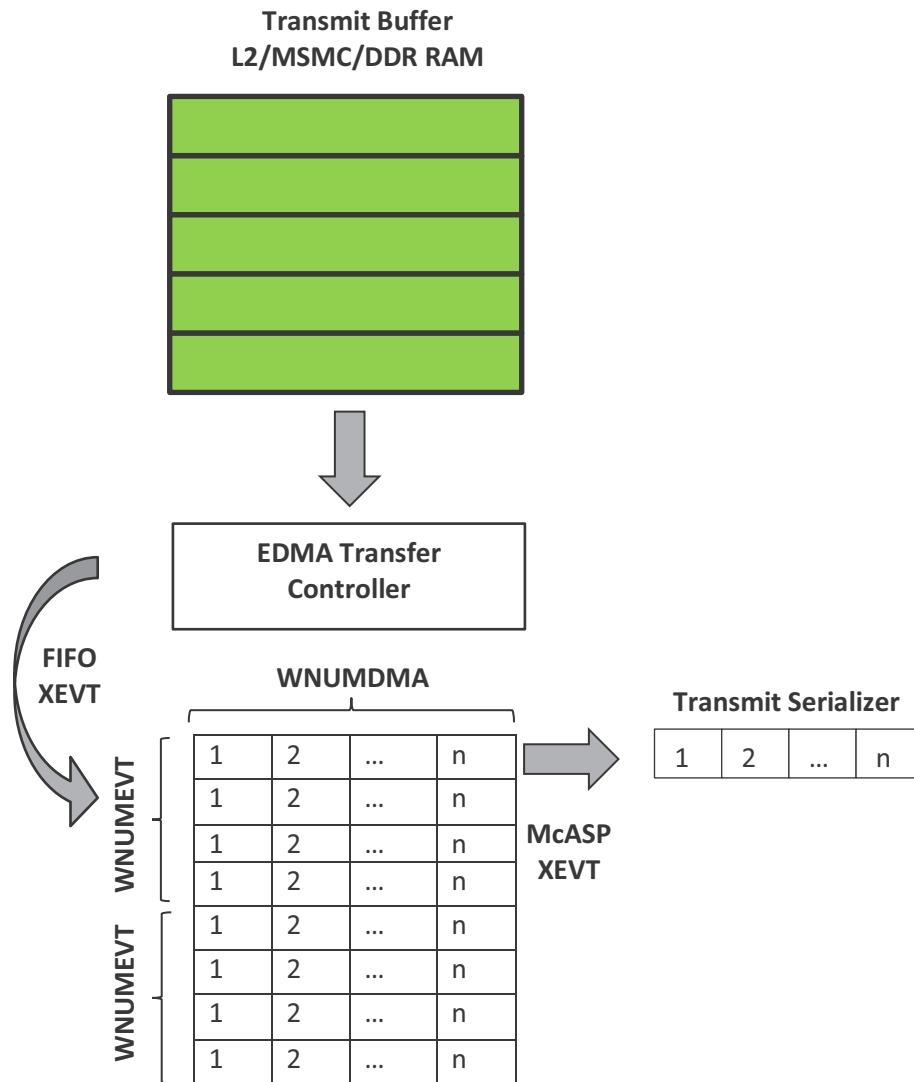
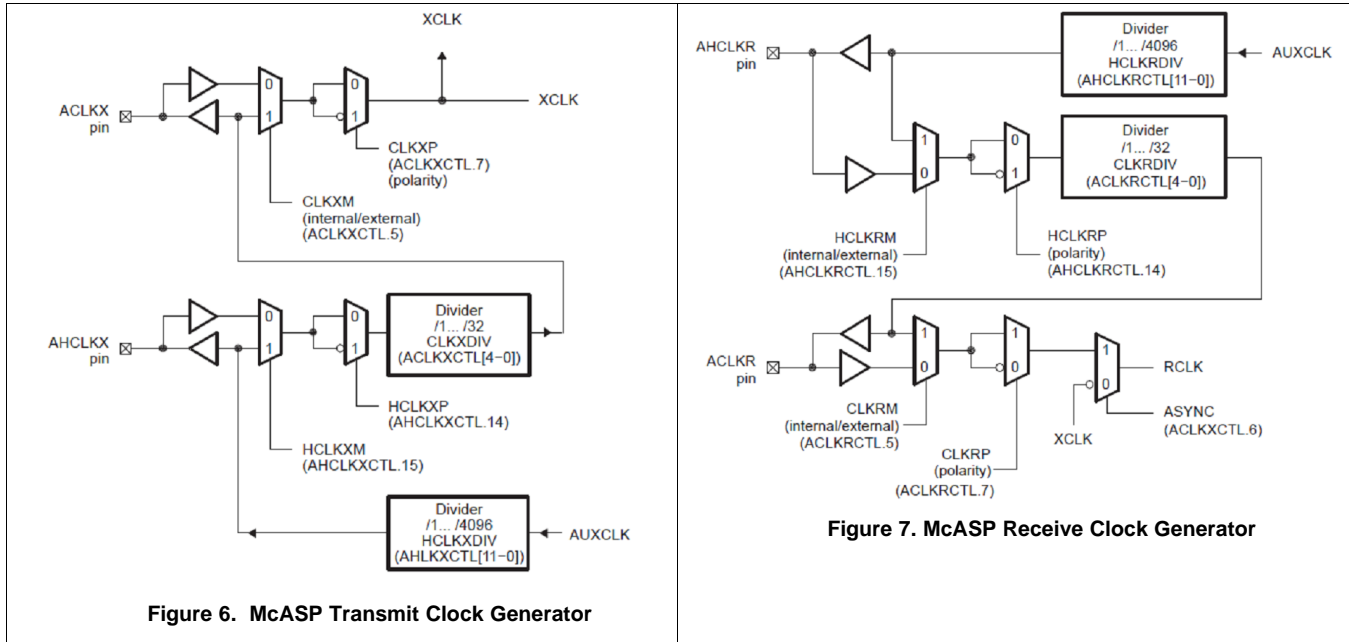

Figure 5. McASP FIFO Usage With EDMA

The software configures the McASP so that data can be input either in 16-bit DSP mode or 32-bit I2S mode from the audio codec. For the 16-bit slot configuration in DSP mode on the audio codec, the McASP is configured for one TDM slot of 32-bit width so that the data is received in packed format (LR) on the McASP. For the 32-bit slot configuration in I2S mode on the audio codec, the McASP is configured for two TDM slots of 32-bit width, and the data is obtained as two channels data on different TDM slots. For both modes, McASP generates frame sync internally. ACLKR and ACLKX are generated internally using high-frequency clock (AHCLKX and AHCLKR) and clock dividers (CLKXDIV and CLKRDIV). The high-frequency clock generates internally from AUXCLK and clock dividers (HCLKXDIV and HCLKRDIV).



4.2 Audio Processing Blocks

4.2.1 Biquad Block

Figure 8 shows the biquad block which consists of four digital biquad filters per channel, organized in a cascaded structure. Each biquad filter has five 64-bit floating point coefficients.

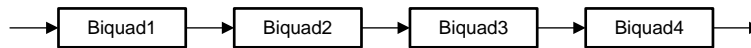

Figure 8. Cascaded Biquad Filters

Figure 9 shows the biquad structure used for the equalization filters.

$$H(z) = \frac{b_0 + b_1Z^{-1} + b_2Z^{-2}}{1 + a_1Z^{-1} + a_2Z^{-2}}$$

Figure 9. Transfer Function for Biquad Filter

The default filter coefficients for each biquad are precomputed, but the demo allows for updating the gain for each filter based on user inputs. Digital audio data coming into the device is processed by the biquad filters, and then output from the device through the audio codec.

The TI Design supports coefficient calculation of the following filter types: peak, high-shelf, low-shelf, high-pass, low-pass, and notch filters. The filters used in this implementation are the high- and low-shelf filters, which implement the 3-band equalization block. A shelving filter applies an equal gain change to all frequencies beyond a user-selected shelving frequency. The shelving filter is selected by specifying the shelf type (bass or treble), the corner frequency, and the amount of cut or boost to be applied. The smooth slopes and the moderate phase shift of the shelving filters creates sonically pleasing audio, which allows the user to adjust the tonal qualities of the audio in a musical way. The gain controls for these bands can be adjusted in a range of 18 dB to -18 dB. In addition, an output gain control can be used to ensure that the maximum gain through the system is less than 0 dB. The filter updates are performed immediately following the filter specification. A gain discontinuity will occur in the output produced by the different filter specifications.

4.2.2 High-Shelf Filter Implementation for Treble Control

High-shelf filters cut or boost the frequency at the cutoff, and all the frequencies higher than the cutoff frequency. High-shelf filters typically have only two parameters: the cutoff frequency and the gain. The TI Design uses a high-shelf filter to manage the gain for all frequencies above 1000 Hz. Figure 10 shows the frequency response of the high-shelf filter used to boost the high frequencies by 6 db.

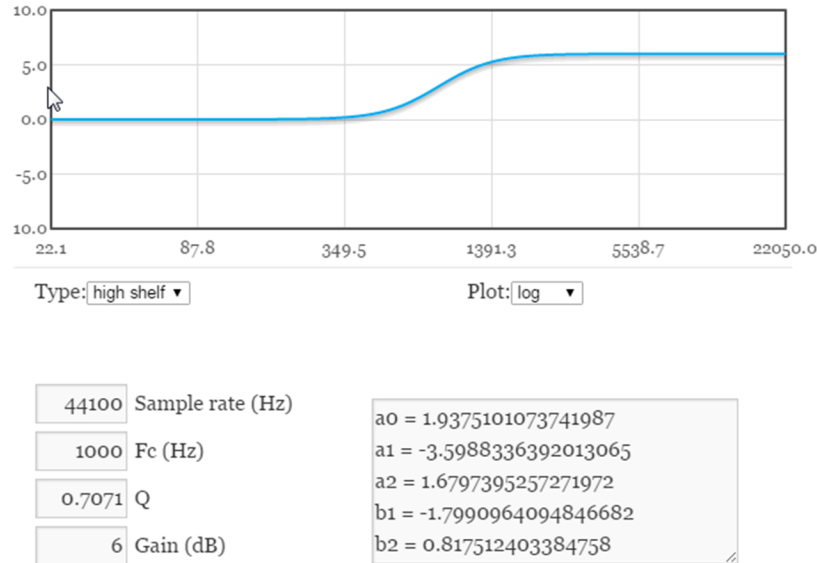

Figure 10. High-Shelf Filter Frequency Response and Coefficients

High-shelf filters are usually used to attenuate or boost the mid-high and high end of the audible spectrum that constitutes the treble. High-shelf filters are used to boost up a track by cutoff frequency of 1 kHz and higher. The filters can also be used to reduce the noise content in an audio track by cutting high frequencies. These controls can be adjusted throughout their entire range of 18 dB to -18 dB to boost or cut the treble.

4.2.3 Low-Shelf Filter Implementation For Bass Control

Low-shelf filters cut or boost the frequency at the cutoff, and all the frequencies lower than the set cutoff point. Low-shelf filters have only two parameters: the cutoff frequency and the gain. The TI Design uses a low-shelf filter to manage the gain and attenuation for all frequencies below 250 Hz. Figure 11 shows the frequency response of the low-shelf filter used to boost the low frequencies by 6 db.

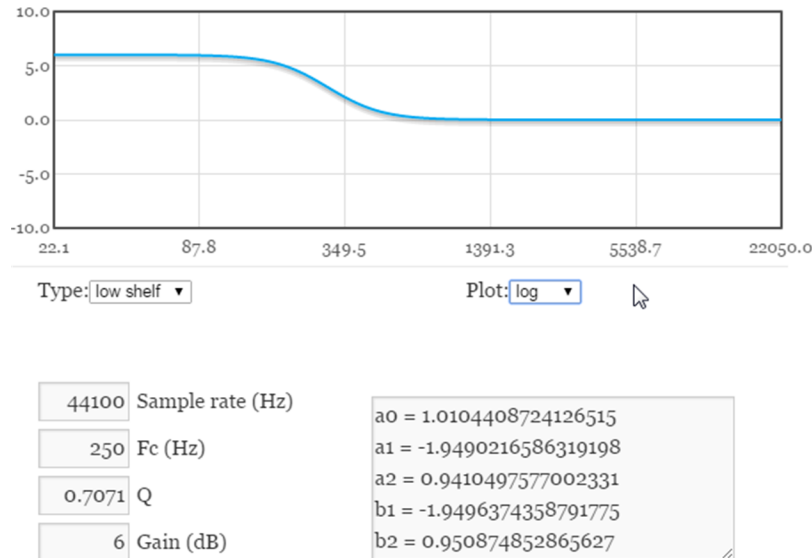

Figure 11. Low-Shelf Filter Frequency Response and Coefficients

Low-shelf filters are usually used in the low-mid and low range of the audible spectrum that constitutes the bass content of the audio. Low-shelf filters can be used to reduce some of the rumble noise caused by microphone stands and other low-end sources, or to boost the vocals of the artist, which are typically at the lower end of the spectrum. These controls can be adjusted throughout their entire range of 18 dB to -18 dB to boost or cut the bass in the audio.

4.2.4 Mid-Band Filter Using Shelving Filters

The design software is configured to use shelving filters instead of band-pass filters, to cut and boost mid-band frequencies in a range from 250 Hz to 1000 Hz. The mid-band gain and attenuation is applied by connecting a high-shelf filter with cutoff frequency 250 Hz, and a low-shelf filter with cutoff frequency at 1000 Hz in cascade. Figure 12 shows the frequency response of the two filters.

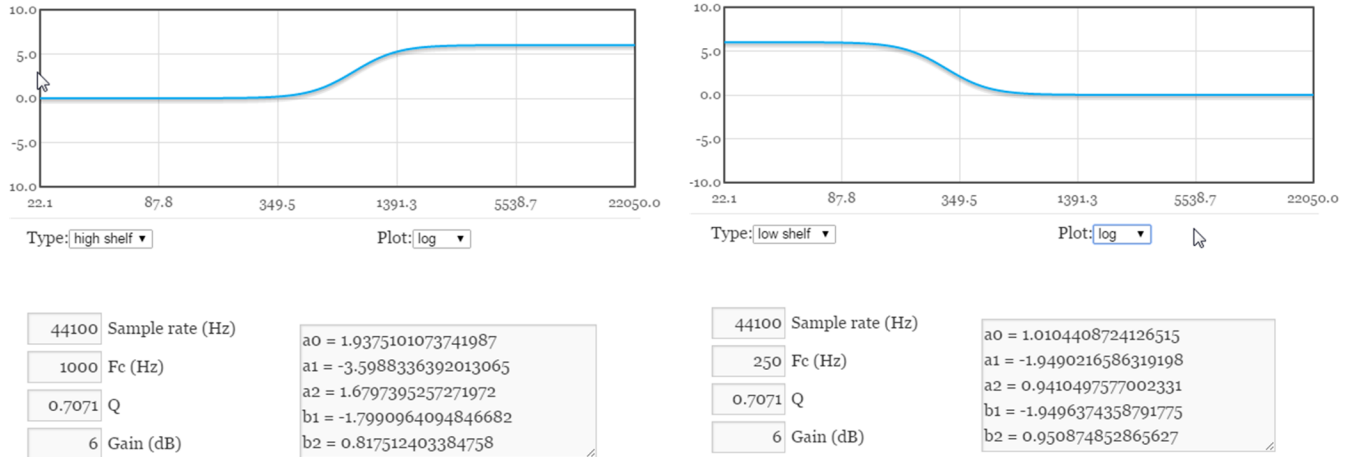

Figure 12. High and Low-Shelf Filter Frequency Response and Coefficients for Mid-Band Gain

These controls can be adjusted throughout their entire range of 18 dB to -18 dB to boost or cut the mid-band frequencies in the input audio.

5 Performance

The following characterization data was measured using a 66AK2G02 with L2 configured as all RAM, 600-MHz CPU clock, and 800-MB/second DDR3. The AEC was configured at a sampling rate of 44.1 kHz to input stereo audio data.

Table 1. CPU and Memory Use

Input Sample Size	Program (KB)	Data (KB)	Per Channel Data/Mcycles	MIPS (MHz)
32-bit	170	400	894	24.66
16-bit	170	400	932	23.64

6 Getting Started

6.1 Equipment

The following items are necessary to run the demonstration:

- TI K2G General-Purpose EVM kit
- Stereo input cable connected to audio source
- Audio listening device (speaker or headphones)
- PC with USB serial port and terminal program (such as KiTTY or TeraTerm)

6.2 Getting Started

Perform the following steps to set up the audio equalizer software on the K2G GP EVM:

6.2.1 Setting Up Hardware

1. Connect the micro USB cable to the onboard emulator USB1 on the K2G GP EVM, and to a USB port of a host PC with Code Composer Studio™ v6.1.2 connected.

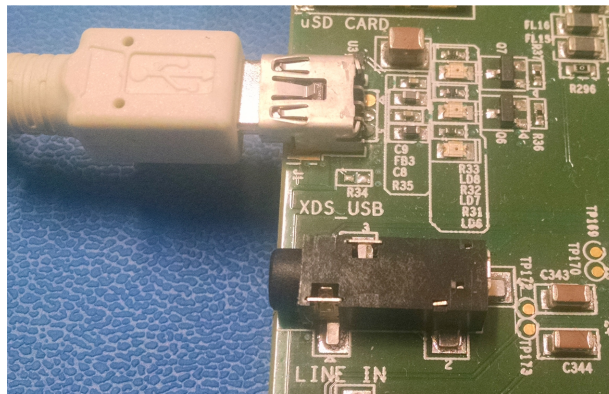

Figure 13. On Board Emulator Connection

2. Connect the mini USB cable from the USB to the SoC UART0 connector, and connect the cable to the host PC. On the host machine (PC), open a serial terminal using Tera Term or Minicom, and set the baud rate to 115200.

NOTE: The connection shows up on the host as a Silicon Labs Dual USB to UART port. Connect to the SoC port connection specified in the EVM manual or Quick Start guide.



Figure 14. General-Purpose EVM UART to USB Port Connection for Serial Output

3. Connect a stereo input cable to the line-in connector, and connect the stereo input cable to an audio source such as a PC, phone, or any other media interface. Also connect a 2.1 speaker or a headphone to the line-out jack.

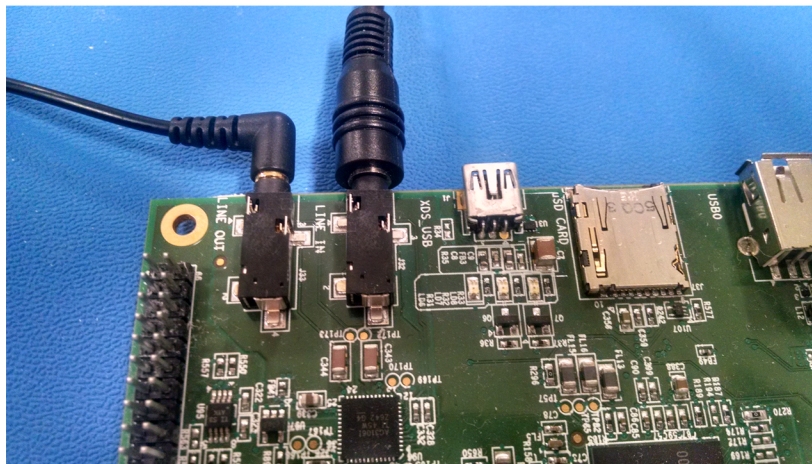

Figure 15. Audio Line-in and Line-out Connections

4. Set boot switches to *No boot mode*, connect a 12-V supply to the power jack, and power up the K2G GP EVM.

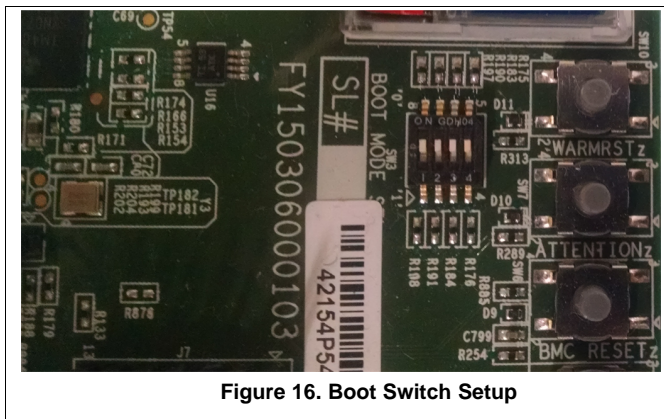

Figure 16. Boot Switch Setup

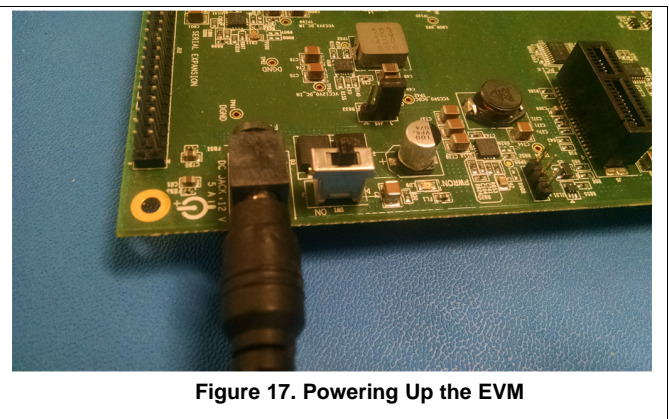

Figure 17. Powering Up the EVM

6.2.2 Installing and Setting Up the Software

1. Download the processor SDK RTOS 2.x.x for K2G platform from ti.com.
2. Install Code Composer Studio IDE (CCSv6.x) compatible with this version of the SDK [Processor SDK RTOS Getting Started Guide](#) wiki.
3. Set up processor SDK RTOS and CCS as described [Processor SDK RTOS Getting Started Guide](#) wiki.
4. Download the ti-design-sw from the external GIT using git clone <https://git.ti.com/apps/tidep0069> audio_equalization.

NOTE: This step applies only to Processor SDK RTOS 2.0.2 users. If using a later version of the SDK, the software is under directory path: processor_sdk_rtos_x_xx_xx_xx/ti-design-sw

6.2.3 Building the Software

The design software can be built in either TI Code Composer Studio (CCS) or by using make files. Both procedures follow:

Using Code Composer Studio

1. Import the Code Composer Studio project audioEQ_demo from the folder path: audio_equalization\evmK2G\build\ccs
2. Set the path to PDK_INSTALL_PATH in the Code Composer Studio environment using the Project Properties, under Resources->Linked Resources, and in Build ->Variables

NOTE: Step 2 applies only to processor SDK RTOS 2.0.2 users. If using a later version of the SDK, the software is under directory path: processor_sdk_rtos_x_xx_xx_xx/ti-design-sw

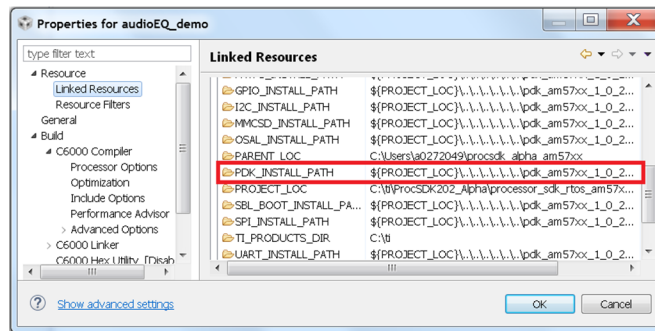

Figure 18. Setting Up Path in CCS Linked Resources

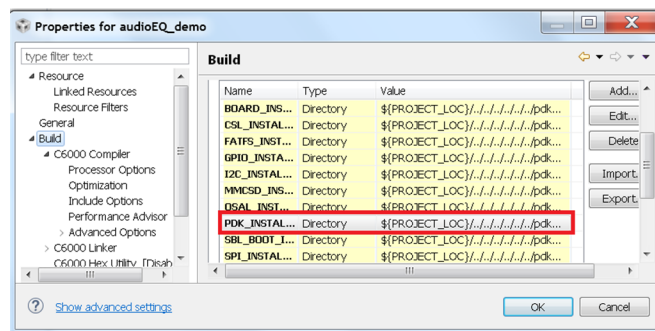

Figure 19. Setting Up Build Variables in CCS

3. Build the audioEQ_demo project in the work space to generate the application binary audioEQ_demo.out

Using Make

1. Set up the processor SDK RTOS build environment by following the steps in the [Processor SDK RTOS Building The SDK](#) wiki.
2. Change the directory to the root directory of the design software and invoke make

For Windows:

```
gmake clean
gmake all
```

For Linux Environment:

```
make clean
make all
```

6.2.4 Running the Software

The design software can be run using the CCS environment or booted on the EVM using an SD card or a flash image. Set up the EVM as described in [Section 6.2.1](#).

Using CCS

1. Create a target configuration file for the general-purpose EVM as described in the [66AK2G02 GP EVM Hardware Setup](#) wiki.
2. Launch the target configuration file and connect to the DSP.
3. Go to menu option Run-> Load Program, and browse to the audioEQ_demo.out file built in the previous section of the design guide.
4. When running the demo, users can hear the audio playback from the source boosted by 12 db, and [Figure 20](#) shows the user console observed on the UART serial terminal.

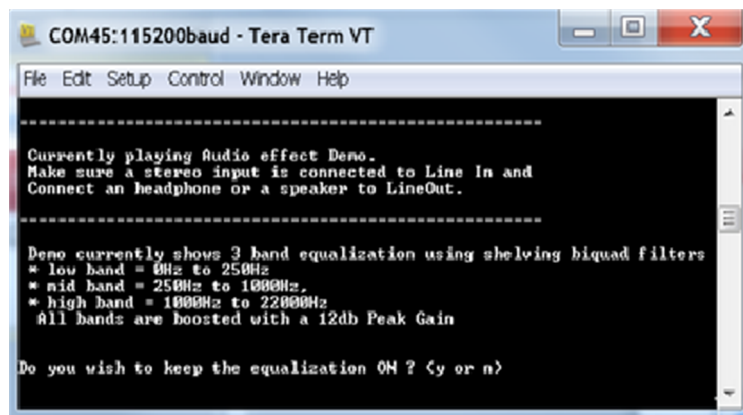

Figure 20. Serial Output Log From the Demo Software

5. Users can use the UART-based user interface to disable the equalizer, hear the audio without the equalization, or adjust the gains on the three bands used in the equalizer.

6.2.5 Customizing the Design Software

Modifying the Equalizer Bands: The frequency bands used in the equalizer are defined by using the cutoff frequency of the biquad filters, which are defined in the file audioEQ_main.c. Modify the cutoff frequencies and default gain defined in the file. Users can also choose to introduce more frequency bands by defining more biquads. However, developers must modify the audio_Echo_Task function defined in the file audioEQ_filtering.c.

Modifying the Type of Filters: The reference design uses shelving biquad filters to boost and attenuate the frequency bands. Users can modify the type of filter used to pass filters or notch filters for testing the performance on the device. Users are also free to use their own coefficients from biquad filters that they may have designed using Matlab or other filter design software.

Modifying the Input Data Format and Sample Rate: Developers can choose to get the input in the form of 16-, 24-, and 32-bit format. The format can be modified by changing the slot length in the AIC_config (AIC31.c), and the McASP channel parameters. Modifying the format also requires changing the receive and transmit format in the mcasp2XmtSetup, and mcasp2RcvSetup structures defined in the file audioEQ_filtering.c. The sampling rate for the input analog data is defined in the AIC31_config structure.

Modifying the Processing Block and User Interface: The software for the UART-based user interface is defined in the function ReadInputTask in audioEQ_main.c, and the processing block is applied to the audio loopback in the function audio_Echo_Task, defined in the file audioEQ_filtering.c. Developers can insert their own processing blocks in the code to test their audio processing algorithms and create custom user interfaces to test it.

7 Design Files

7.1 Schematics

The design files for the K2G General-Purpose EVM are found at: <http://www.ti.com/tool/EVMK2GX>

8 Software Files

To download the software files for this reference design, see the link:

- [ProcessorSDK_RTOS_K2G](#)
- **External GIT:** <https://git.ti.com/apps/tidep0069> (Separate download for processor SDK RTOS 2.0.2 only)

9 Related Documentation

1. Texas Instruments E2E Community, <http://e2e.ti.com/>
2. Musicdsp.org, <http://www.musicdsp.org/files/Audio-EQ-Cookbook.txt>
3. Ear Level Engineering, <http://www.earlevel.com/main/2012/11/26/biquad-c-source-code/>
4. Ear Level Engineering, <http://www.earlevel.com/main/2010/12/20/biquad-calculator/>
5. *TMS320DM645 Video/Imaging Fixed-Point Digital Signal Processor Data Manual (SPRS392)*

9.1 Trademarks

Code Composer Studio is a trademark of Texas Instruments.
Arm, Cortex are registered trademarks of Arm Limited.

10 About the Author

RAHUL PRABHU is a Senior Software Applications Engineer in TI's Embedded Processing organization, supporting Arm-based and DSP-based SoCs, such as, AM57xx, 66AK2EXX, OMAPL138, and C667x devices. Rahul brings extensive experience and knowledge in signal processing, optimizing algorithms, system integration, and application development to this role. Rahul earned his M.S. degree in Electrical and Computer Engineering from the University of Houston.

Revision History

NOTE: Page numbers for previous revisions may differ from page numbers in the current version.

Changes from Original (May 2016) to A Revision	Page
• Changed document title to "66AK2Gx"	1
• Added 66AK2G12 Product Folder	1
• Changed EVM Tool Folder to EVMK2GX.....	1

IMPORTANT NOTICE FOR TI DESIGN INFORMATION AND RESOURCES

Texas Instruments Incorporated ("TI") technical, application or other design advice, services or information, including, but not limited to, reference designs and materials relating to evaluation modules, (collectively, "TI Resources") are intended to assist designers who are developing applications that incorporate TI products; by downloading, accessing or using any particular TI Resource in any way, you (individually or, if you are acting on behalf of a company, your company) agree to use it solely for this purpose and subject to the terms of this Notice.

TI's provision of TI Resources does not expand or otherwise alter TI's applicable published warranties or warranty disclaimers for TI products, and no additional obligations or liabilities arise from TI providing such TI Resources. TI reserves the right to make corrections, enhancements, improvements and other changes to its TI Resources.

You understand and agree that you remain responsible for using your independent analysis, evaluation and judgment in designing your applications and that you have full and exclusive responsibility to assure the safety of your applications and compliance of your applications (and of all TI products used in or for your applications) with all applicable regulations, laws and other applicable requirements. You represent that, with respect to your applications, you have all the necessary expertise to create and implement safeguards that (1) anticipate dangerous consequences of failures, (2) monitor failures and their consequences, and (3) lessen the likelihood of failures that might cause harm and take appropriate actions. You agree that prior to using or distributing any applications that include TI products, you will thoroughly test such applications and the functionality of such TI products as used in such applications. TI has not conducted any testing other than that specifically described in the published documentation for a particular TI Resource.

You are authorized to use, copy and modify any individual TI Resource only in connection with the development of applications that include the TI product(s) identified in such TI Resource. NO OTHER LICENSE, EXPRESS OR IMPLIED, BY ESTOPPEL OR OTHERWISE TO ANY OTHER TI INTELLECTUAL PROPERTY RIGHT, AND NO LICENSE TO ANY TECHNOLOGY OR INTELLECTUAL PROPERTY RIGHT OF TI OR ANY THIRD PARTY IS GRANTED HEREIN, including but not limited to any patent right, copyright, mask work right, or other intellectual property right relating to any combination, machine, or process in which TI products or services are used. Information regarding or referencing third-party products or services does not constitute a license to use such products or services, or a warranty or endorsement thereof. Use of TI Resources may require a license from a third party under the patents or other intellectual property of the third party, or a license from TI under the patents or other intellectual property of TI.

TI RESOURCES ARE PROVIDED "AS IS" AND WITH ALL FAULTS. TI DISCLAIMS ALL OTHER WARRANTIES OR REPRESENTATIONS, EXPRESS OR IMPLIED, REGARDING TI RESOURCES OR USE THEREOF, INCLUDING BUT NOT LIMITED TO ACCURACY OR COMPLETENESS, TITLE, ANY EPIDEMIC FAILURE WARRANTY AND ANY IMPLIED WARRANTIES OF MERCHANTABILITY, FITNESS FOR A PARTICULAR PURPOSE, AND NON-INFRINGEMENT OF ANY THIRD PARTY INTELLECTUAL PROPERTY RIGHTS.

TI SHALL NOT BE LIABLE FOR AND SHALL NOT DEFEND OR INDEMNIFY YOU AGAINST ANY CLAIM, INCLUDING BUT NOT LIMITED TO ANY INFRINGEMENT CLAIM THAT RELATES TO OR IS BASED ON ANY COMBINATION OF PRODUCTS EVEN IF DESCRIBED IN TI RESOURCES OR OTHERWISE. IN NO EVENT SHALL TI BE LIABLE FOR ANY ACTUAL, DIRECT, SPECIAL, COLLATERAL, INDIRECT, PUNITIVE, INCIDENTAL, CONSEQUENTIAL OR EXEMPLARY DAMAGES IN CONNECTION WITH OR ARISING OUT OF TI RESOURCES OR USE THEREOF, AND REGARDLESS OF WHETHER TI HAS BEEN ADVISED OF THE POSSIBILITY OF SUCH DAMAGES.

You agree to fully indemnify TI and its representatives against any damages, costs, losses, and/or liabilities arising out of your non-compliance with the terms and provisions of this Notice.

This Notice applies to TI Resources. Additional terms apply to the use and purchase of certain types of materials, TI products and services. These include; without limitation, TI's standard terms for semiconductor products (<http://www.ti.com/sc/docs/stdterms.htm>), [evaluation modules](#), and [samples](http://www.ti.com/sc/docs/sampterm.htm) (<http://www.ti.com/sc/docs/sampterm.htm>).

Mailing Address: Texas Instruments, Post Office Box 655303, Dallas, Texas 75265
Copyright © 2018, Texas Instruments Incorporated