

TI Designs: TIDA-050018

Low-Power AAA-Battery Reference Design With 6- μ A Standby Power for Multi-Purpose Sensor



Description

This reference design demonstrates a low-power boost converter solution used for door and windows sensors. The design includes an alkaline battery, an ultra-low quiescent-current boost converter and ultra-low power consuming digital Hall effect sensors. It can also power an ultra-low power, sub-1-GHz wireless microcontroller used to transmit the status of sensors.

Resources

TIDA-050018	Design Folder
TPS61098	Product Folder
DRV5032	Product Folder
TIDA-01066	Design Folder

Features

- Powered Source From an Alkaline Battery
- 300-nA Ultra-Low IQ Boost Converter
- Integrated LDO for Noise-Sensitive Load
- Magnetic Field Sensing Always Powered On to Enable Continuous Monitoring
- Dual-Sensor Architecture Detects Tampering Magnet

Applications

- [Building Automation](#)
- [Door and Window Sensor](#)
- [Home Remote Control](#)



[ASK Our E2E™ Experts](#)

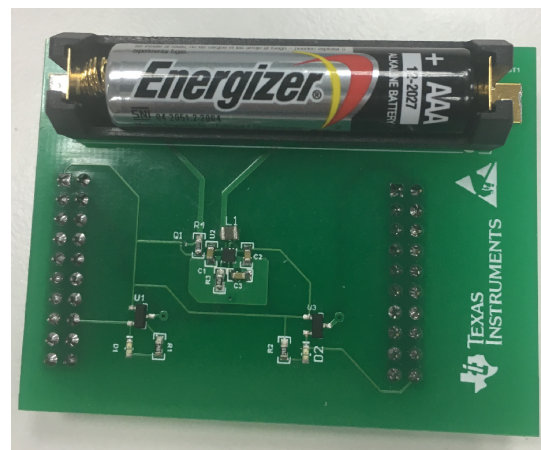
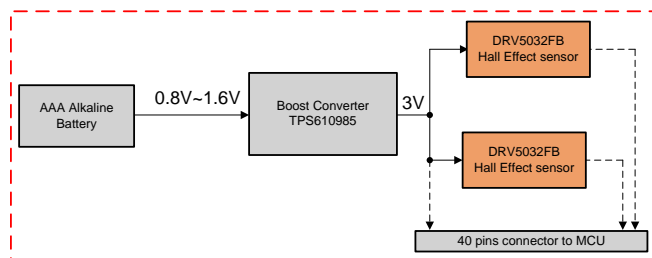

An IMPORTANT NOTICE at the end of this TI reference design addresses authorized use, intellectual property matters and other important disclaimers and information.

1 System Description

Many industrial and building automation systems use sensors to monitor whether the doors and windows are opened or closed. A central monitoring device generates alarms based on the information from multiple door and window sensors. These systems require wireless sensor nodes to reduce installation costs and to make the systems more flexible for future expansion. The wireless sensor node is powered by a battery, the voltage of which depends on the battery type and the remaining capacity. For example, the voltage of an alkaline battery varies from 1.5 V to 0.8 V in its operating lifetime. Magnets are commonly used in window and door sensor node to determine if a window or door is opened or closed. In a typical configuration the magnet is embedded in the window or door, and the sensor is attached to the window or door frame. The sensor and magnet are placed so that they are in close proximity when the door or window is closed and away from each other when the window or door is opened. Texas Instruments' ultra-low-power digital Hall effect sensors are designed for such applications. Besides magnets, shock sensors can be also used to detect the motion of the door or window. The power supply for the Hall effect sensors is at least 1.8 V, thus an ultra-low IQ boost converter is required if the system is supplied by an alkaline battery. The output of the boost converter also provides stable voltage to the ultra-low-power wireless microcontroller (MCU). The wireless MCU is required to transmit the sensor status to the central monitoring device.

This reference design includes an alkaline battery, an ultra-low IQ boost converter, and two ultra-low-power digital Hall effect sensors. The reference design can be connected with the CC1310 LaunchPad™ through two receptacles to demonstrate the wireless communication function in the security system.

1.1 Key System Specifications

Table 1. Key System Specifications

PARAMETER	SPECIFICATIONS
Input power source	AAA alkaline battery, voltage from 1.6 V to 0.8 V
Output voltage of the boost	3 V
Output current capability of the boost	90 mA at 1.2-V battery voltage
Sensor sampling frequency	5 Hz
Sensor type	Hall effect
Average standby current consumption	6 μ A at 25°C room temperature

2 System Overview

2.1 Block Diagram

Figure 1. TIDA-050018 Block Diagram

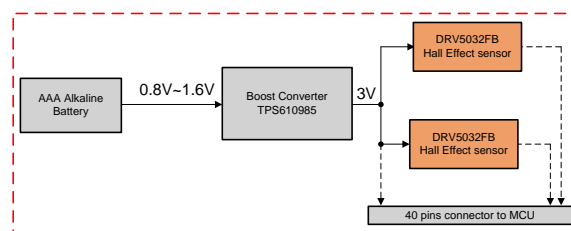

2.2 Highlighted Products

This TI Design features the following devices:

- TPS61098 ultra-low quiescent current synchronous boost with integrated LDO or load switch
- DRV5032 ultra-low power digital-switch Hall effect sensor

The 40-pin connector enables the board attaching to a wireless MCU CC1310 launch pad. More information about configuration of the wireless MCU can be found in the reference design [Low Power Door/Window Sensor with Sub-1GHz and 10-Year Battery Life Design Guide](#).

2.2.1 TPS610985

TPS610985 is an ultra-low quiescent-current synchronous boost. It integrates a LDO or low switch depend on the version. the device has two operation modes controlled by MODE pin: active mode and low-power mode. In active mode, both outputs are enabled with enhanced response performance. In low-power mode, the LDO or load switch is disabled to disconnect the peripheral components. The TPS61098x consumes only 300-nA quiescent current and can achieve up to 88% efficiency at 10- μ A load in low-power mode. The TPS61098x can provide up to 50-mA total output current at 0.7-V input to 3.3-V output conversion. The TPS610985 device is based on a hysteretic current controller topology, and it integrates synchronous rectifier to obtain maximum efficiency. The TPS61098x is available in 1.5-mm \times 1.5-mm WSON package to enable small circuit layout size.

2.2.2 DRV5032

The DRV5032 is an ultra-low-power digital switch Hall effect sensor, designed for the most compact and battery-sensitive systems. The device is offered in multiple magnetic sensitivities, sampling rates, output drivers, and packages to accommodate various applications.

When the applied magnetic flux density exceeds the B_{OP} threshold, a device output drives a low voltage. The output stays low until the flux density decreases to less than B_{RP} , and then the output either becomes high-impedance or drives a high voltage, depending on the device version. By incorporating an internal oscillator, the DRV5032 samples the magnetic field and updates the output at a rate of 20 Hz, or 5 Hz for the lowest current consumption. Both omnipolar and unipolar magnetic responses are available. The features of DRV5032 include:

- Industry-leading ultra-low power consumption
- 1.65-V to 5.5-V operating range
- Omnipolar or unipolar magnetic response
- 20-Hz and 5-Hz sample rate options
- SOT-23 or small SON package

In the DRV5032 product folder, there is a *magnetic field calculator* as shown in [Figure 2](#). For the NdFeB grade-38 6-mm cylinder magnet components, the distance toggling the signal in OUT is approximately 20 mm.

Figure 2. Magnetic Field Calculator

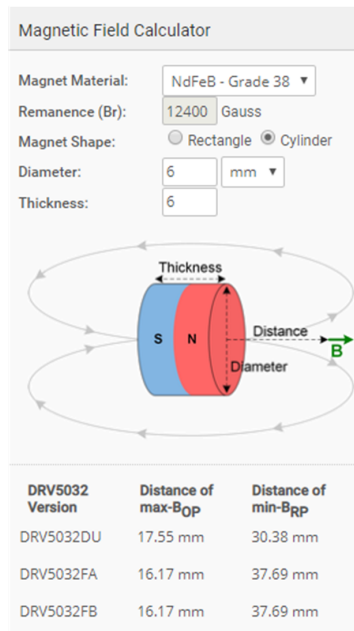

2.3 System Design Theory

The designed circuit can be divided into boost converter power solution and the Hall effect sensor circuit.

2.3.1 Power Supply Design

The circuit of the boost converter is shown in [Figure 3](#). The TPS610985 requires three components to generate 3 V from an alkaline battery input: input capacitor, inductor, and output capacitor. For this application, it is sufficient to have 10- μ F ceramic capacitor for the input and output. The inductor is 4.7 μ H with at least 400-mA current capability. For TPS610985, there is a switcher between the VMAIN and VSUB. When MODE pin is logic low, the switcher is off, so there is no voltage in the VSUB. When MODE pin is logic high, the switching is on, so the VSUB voltage follows the voltage of VMAIN. The VSUB can be used to power the loading, which consumes lots of energy but is not frequently powered up. Because the device consumes more quiescent current when MODE is high, the VSUB should be turned off for most of the time.

Figure 3. Boost Converter Schematic

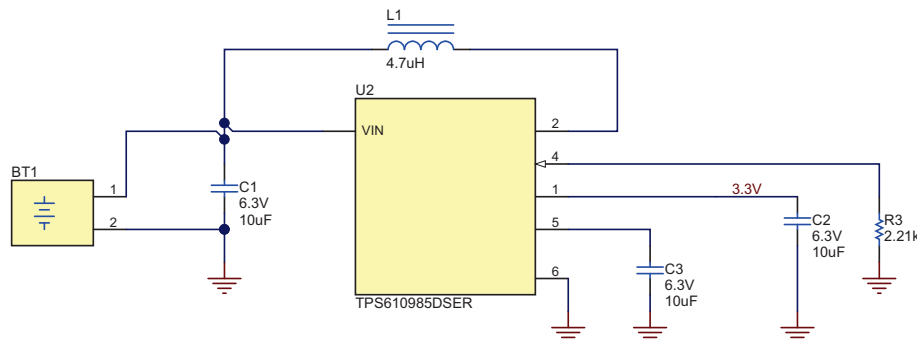

2.3.2 Hall Effect Sensor Design

The external circuit is shown in Figure 4. The power supply is 3 V. The LED indicates the changing of the magnetic field. If the magnetic field is higher than typical 3 mT, the OUT pin output logic is low, and the LED D2 turns on. The OUT pin becomes logic high again if the magnetic field is lower than typical 1.5 mT.

Figure 4. Hall Effect Sensor Circuit

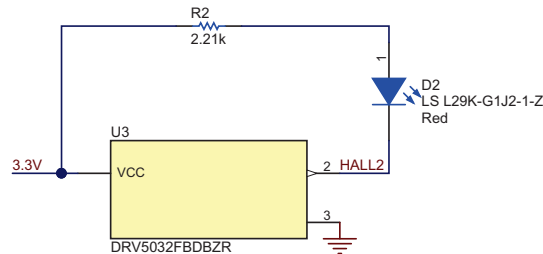

3 Test Results

The following shows the test results of this reference design. During the measurement, the power source can be electronic power supply or an alkaline battery.

3.1 Standby Current Consumption

Table 2 shows the standby input current of the reference design at different input voltages. The input current is approximately 6 μ A from typical 1.2-V battery voltage.

Table 2. Standby Input Current

PARAMETER	BATTERY OUTPUT CURRENT AT DIFFERENT VOLTAGE							
	0.8	0.9	1	1.1	1.2	1.3	1.4	1.5
Battery voltage (V)	0.8	0.9	1	1.1	1.2	1.3	1.4	1.5
Standby current (μ A)	10	8.4	7.3	6.4	5.7	5.2	4.8	4.3

3.2 Boost Converter Operating Waveform

In standby condition, the TPS610981 operates at burst mode as the loading is very small. In the burst mode, the device switches several cycles to ramp up the V_{OUT} , and then most of the internal circuit shuts down to reduce power loss. After the output voltage decreases to a threshold, the device starts to switch again. The output ripple is approximately 20 mV shown in

Figure 5. Boost Converter Output Ripple at Standby Mode

Figure 6 and Figure 7 show the load transient performance of the TPS610981. When the output current is zero, the device operates at burst mode. The average output voltage is approximately 3.1 V at burst mode, which is 100 mV higher than setting 3-V output because the internal circuit of the device needs the extra 100 mV to enter or exit the burst mode. After the loading increases to 10 mA or 50 mA, the device exits the burst mode. The output voltage is regulated at 3 V.

Figure 6. Boost Load Transient From 0 mA to 10 mA

Figure 7. Boost Load Transient From 0 mA to 50 mA

3.3 Magnet Response

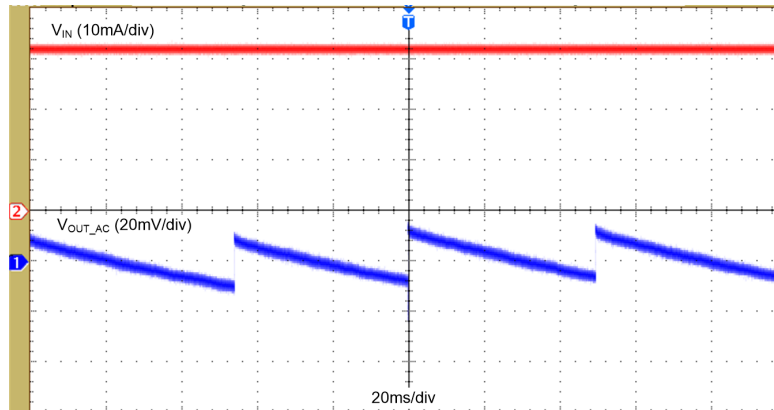
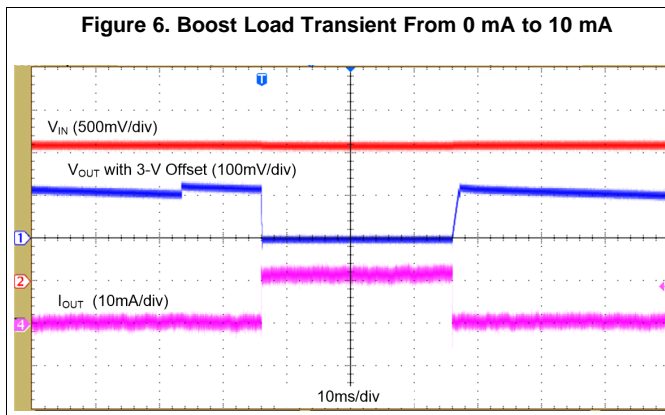
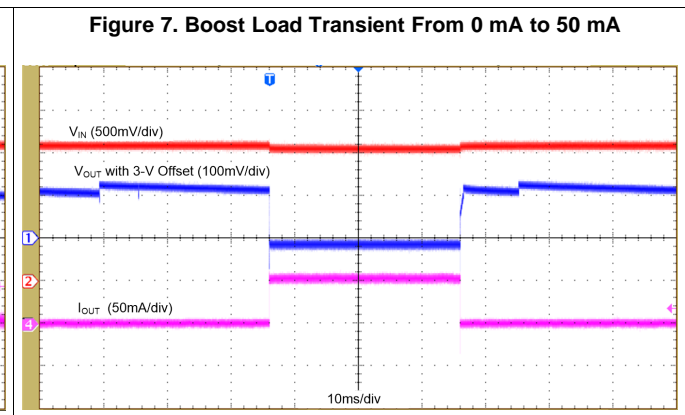
In Figure 8, a cylindrical magnet (6-mm diameter and 6-mm height) is placed on the top of the Hall effect sensor DRV5032. If the distance between the sensor and the magnet is shorter than approximately 16 mm, the sensor outputs logic low and turns on the red LED. If the distance is longer than approximately 22 mm, the sensor outputs high logic and turns off the LED. In Figure 9, the magnet is placed closer, so both the sensors output logic low to indicate the tampering magnet.

Figure 8. Magnetic Field Test

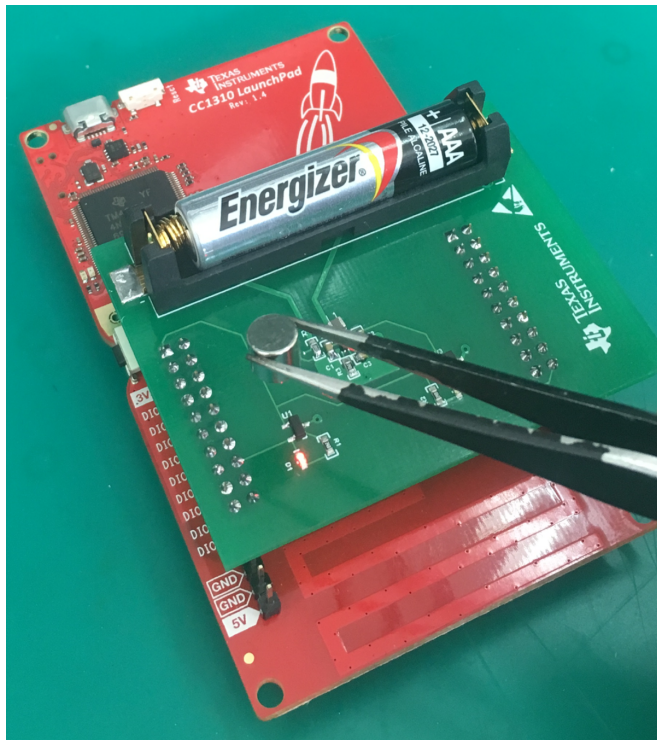
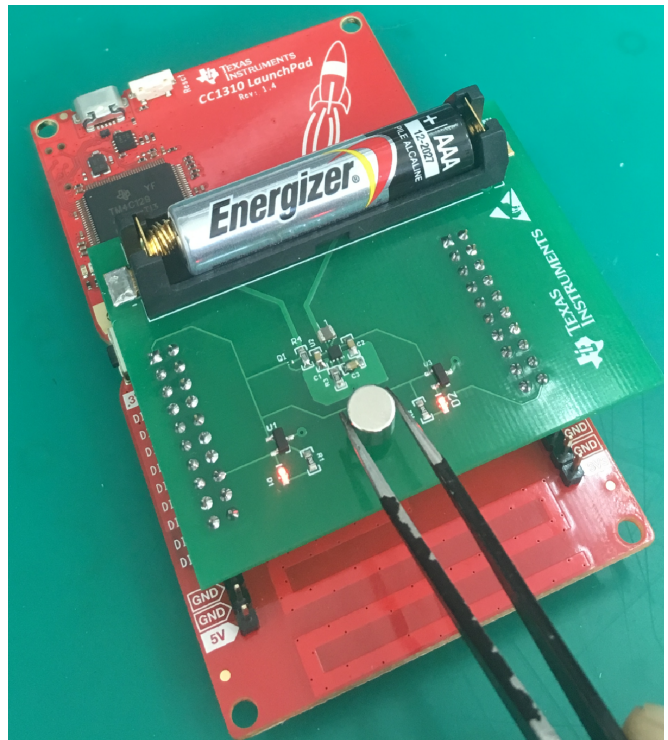

Figure 9. Magnetic Field Test (Close Up)



3.4 Battery Life Estimation

The battery-life time depends on the energy consumption of the loading as well as the self-discharge of the battery. An alkaline battery loses approximately 3% of its capacity per year when stored at 20°C due to slow electrochemical reactions that continually occur. Warm temperatures increases the reaction. At 40°C, the battery loses 20% of its capacitance after five years of storage.

In this reference design, the alkaline battery is an AAA type. Its typical capacity relates to the discharge current. Using an Energizer alkaline battery as an example, the capacitor is approximately 1100 milliamp-hour at 25-mA discharging current and 900 milliamp-hour at 100-mA discharging current. In this application, the maximum loading current is less than 10 mA caused by the wireless packet transmit. The current out of the battery is less than 30 mA, so 1100 milliamp-hour (mAh) battery capacity can be used to estimate the battery life time.

Considering 5-years lifetime, the total capacity is used by the loading is approximately 880 mAh (0.8 × 1100 mA). Assuming 6-μA standby current, this current sums up to 260 mAh for 5 years, so there will be 520-mAh battery capacity left for the wireless device and other sensors. The average loading current from the output of the boost can then be calculated by Equation 1, which is approximately 4 μA.

$$I_{IN} = \frac{\text{Battery Capacity (mAh)}}{n \times 8760 \text{ hours}} \times \frac{V_{IN} \times \eta}{V_{OUT}}$$

where

- n is 5 years
- V_{IN} is the boost input voltage (average is 1.2 V)
- V_{OUT} is 3-V boost output voltage
- η is the efficiency of the boost, approximately 0.85

(1)

From the reference design [TIDUC69](#), the power consumption of the wireless communication is only 0.3 μA. Thus, there is approximately 3.7 μA for other loading, such as temperature sensor or humidity sensor.

4 Design Files

4.1 Schematics

To download the schematics, see the design files at [TIDA-050018](#).

4.2 Bill of Materials

To download the bill of materials (BOM), see the design files at [TIDA-050018](#).

4.3 PCB Layout Recommendations

4.3.1 Layout Prints

To download the layer plots, see the design files at [TIDA-050018](#).

4.4 Altium Project

To download the Altium Designer® project files, see the design files at [TIDA-050018](#).

4.5 Gerber Files

To download the Gerber files, see the design files at [TIDA-050018](#).

4.6 Assembly Drawings

To download the assembly drawings, see the design files at [TIDA-050018](#).

5 Related Documentation

1. [Low Power Door/Window Sensor with Sub-1GHz and 10-Year Battery Life Design Guide](#)
2. [TPS61098x Ultra-Low Quiescent Current Synchronous Boost with Integrated LDO/Load Switch](#)

5.1 Trademarks

E2E, LaunchPad are trademarks of Texas Instruments.
Altium Designer is a registered trademark of Altium LLC or its affiliated companies.
All other trademarks are the property of their respective owners.

5.2 Third-Party Products Disclaimer

TI'S PUBLICATION OF INFORMATION REGARDING THIRD-PARTY PRODUCTS OR SERVICES DOES NOT CONSTITUTE AN ENDORSEMENT REGARDING THE SUITABILITY OF SUCH PRODUCTS OR SERVICES OR A WARRANTY, REPRESENTATION OR ENDORSEMENT OF SUCH PRODUCTS OR SERVICES, EITHER ALONE OR IN COMBINATION WITH ANY TI PRODUCT OR SERVICE.

IMPORTANT NOTICE AND DISCLAIMER

TI PROVIDES TECHNICAL AND RELIABILITY DATA (INCLUDING DATASHEETS), DESIGN RESOURCES (INCLUDING REFERENCE DESIGNS), APPLICATION OR OTHER DESIGN ADVICE, WEB TOOLS, SAFETY INFORMATION, AND OTHER RESOURCES "AS IS" AND WITH ALL FAULTS, AND DISCLAIMS ALL WARRANTIES, EXPRESS AND IMPLIED, INCLUDING WITHOUT LIMITATION ANY IMPLIED WARRANTIES OF MERCHANTABILITY, FITNESS FOR A PARTICULAR PURPOSE OR NON-INFRINGEMENT OF THIRD PARTY INTELLECTUAL PROPERTY RIGHTS.

These resources are intended for skilled developers designing with TI products. You are solely responsible for (1) selecting the appropriate TI products for your application, (2) designing, validating and testing your application, and (3) ensuring your application meets applicable standards, and any other safety, security, or other requirements. These resources are subject to change without notice. TI grants you permission to use these resources only for development of an application that uses the TI products described in the resource. Other reproduction and display of these resources is prohibited. No license is granted to any other TI intellectual property right or to any third party intellectual property right. TI disclaims responsibility for, and you will fully indemnify TI and its representatives against, any claims, damages, costs, losses, and liabilities arising out of your use of these resources.

TI's products are provided subject to TI's Terms of Sale (www.ti.com/legal/termsofsale.html) or other applicable terms available either on ti.com or provided in conjunction with such TI products. TI's provision of these resources does not expand or otherwise alter TI's applicable warranties or warranty disclaimers for TI products.

Mailing Address: Texas Instruments, Post Office Box 655303, Dallas, Texas 75265
Copyright © 2018, Texas Instruments Incorporated