

DRV8308 EVM GUI

This document describes how to use the DRV8308EVM to spin sensored brushless DC motors, as well as a tuning process for the DRV8308 speed control system.

Contents

| | | |
|---|--|----|
| 1 | DRV8308 EVM Overview | 3 |
| | 1.1 External Lab Requirements | 4 |
| | 1.2 Configuration Jumpers | 5 |
| 2 | GUI Software Installation | 7 |
| | 2.1 System Requirements..... | 8 |
| | 2.2 Installation Procedure | 8 |
| 3 | DRV8308 EVM GUI..... | 15 |
| | 3.1 Quick Guide to Spin With Open-Loop PWM..... | 15 |
| | 3.2 Quick Guide to Spin With Speed Control | 16 |
| | 3.3 The Third GUI tab | 16 |
| | 3.4 If the GUI Has Slow Performance..... | 16 |
| | 3.5 Menu Options | 17 |
| 4 | Tuning the Speed-Control System | 19 |
| | 4.1 Key Registers | 19 |
| | 4.2 Tuning Process | 20 |

List of Figures

| | | |
|----|---|----|
| 1 | DRV8308 EVM..... | 3 |
| 2 | DRV8308 System Diagram..... | 4 |
| 3 | Hall PWR and GND Circuits..... | 6 |
| 4 | Circuit When Setting Hall Current to Power..... | 6 |
| 5 | JP3 Control Whether 6 Controls are Made..... | 7 |
| 6 | S.MODE | 7 |
| 7 | GUIComposerApp-0.1.0.setup-win_2.0.4..... | 8 |
| 8 | Installation Initialization | 9 |
| 9 | License Agreement | 10 |
| 10 | Installation Directory | 10 |
| 11 | GUI Composer Runtime | 11 |
| 12 | Downloading GUI Composer Runtime | 12 |
| 13 | Self-Extraction of GUI Composer Runtime | 12 |
| 14 | Installation in Progress | 13 |
| 15 | Setup Completion | 14 |
| 16 | Readme Window | 14 |
| 17 | Jumpers | 15 |
| 18 | Wiring the Motor..... | 15 |
| 19 | File Menu..... | 17 |
| 20 | Edit Menu | 17 |
| 21 | Options Menu | 18 |
| 22 | Help Menu..... | 18 |

| | | |
|----|-----------------|----|
| 23 | About Page..... | 19 |
|----|-----------------|----|

List of Tables

| | | |
|---|----------------------------|---|
| 1 | Jumper Configuration | 5 |
|---|----------------------------|---|

Trademarks

MSP430, E2E are trademarks of Texas Instruments.

1 DRV8308 EVM Overview

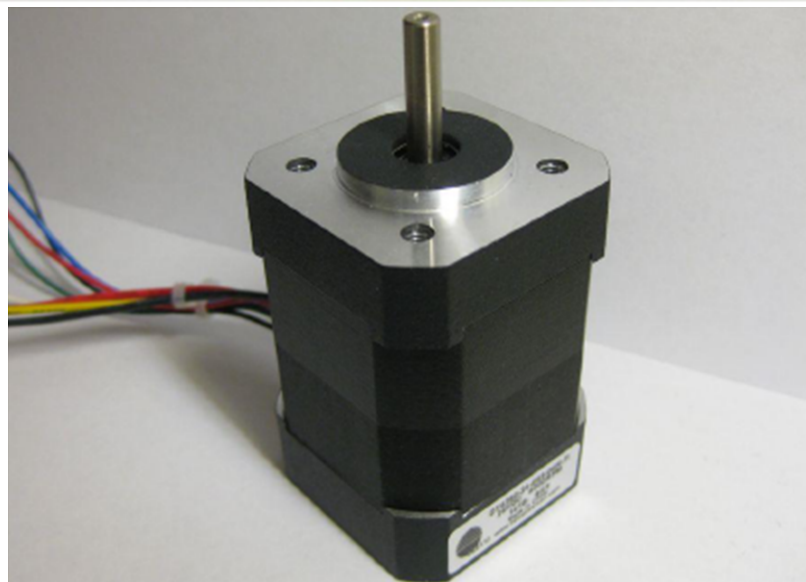
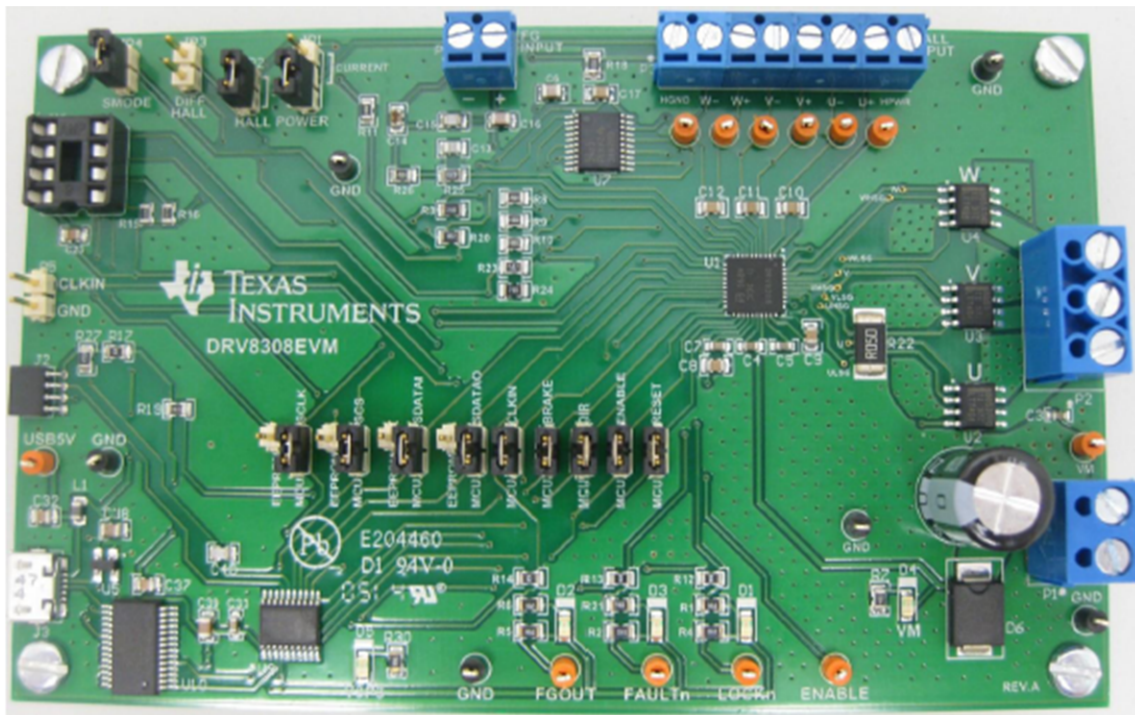
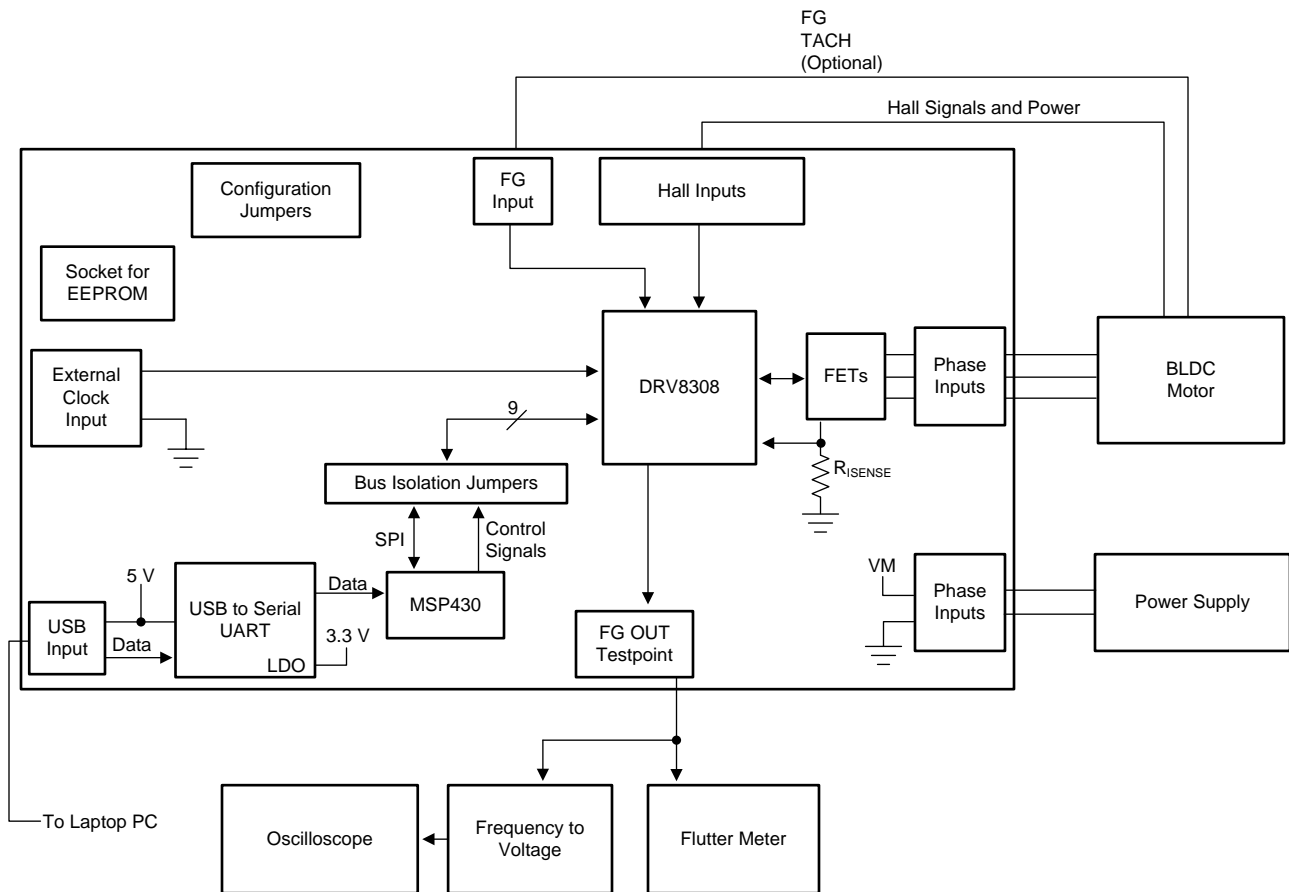

Figure 1. DRV8308 EVM

The DRV8308EVM makes it easy to evaluate the DRV8308 device with different BLDC motors. The kit includes the main PCB, a BLDC motor that uses DRV5013 Hall Effect sensors, a micro USB cable, and a downloadable Windows application that controls and monitors the DRV8308 with a graphical user interface (GUI).

Figure 2 shows the DRV8308 system diagram.



Copyright © 2017, Texas Instruments Incorporated

Figure 2. DRV8308 System Diagram

1.1 External Lab Requirements

The following is required:

Power supply — The supply should be set to a voltage from 8.5 V to 32 V, and a current of at least 1 A. A higher current setting is better, as it helps maintain a stable VM voltage, speeds spin-up time, and increases the torque capability. The DRV8308 limits peak current to 5 A on this board, because the sense resistor is sized at 0.05 Ω , and the VLIMITER voltage is 0.25 V.

Flutter meter — When the motor rotates, it generates a periodic waveform on each Hall phase, and optionally on the FG line. The DRV8308 FGSEL register sets which input to use for the speed-control loop and pass to FGOUT.

Flutter meters can analyze the FGOUT signal and calculate a jitter percentage. This jitter, or variation in edge timing, is a measure of motor-speed consistency. Right flutter values are typically from 0.03% to 0.5%. Some causes of jitter are:

- Magnetic cogging force. Motors with high detent torque have more speed variation when spinning.
- Non-ideal motor windings

Improperly-tuned DRV8308 register settings when in Clock Frequency Mode. The speed-control loop of the device has a configurable pole and zero frequencies, and gain values, and they significantly affect jitter performance. Some BLDC outrunner motors have a PCB mounted to the backside with a board trace antenna that senses magnetic reluctance. This *FG trace* is drawn like a square wave leading in a circle. When the motor spins, a low-level sinusoidal voltage is generated on the trace. The DRV8308 can use this signal to sense motor speed with FGSEL set to 10b.

Because implementations often causes about 30 to 60 FG cycles per physical revolution, and only 3 to 6 Hall U cycles often occur per physical revolution, FG has an advantage of providing faster speed feedback which can improve jitter performance. For motors that lack FG, setting FGSEL to 00b to use HALL U is best. This setting can achieve very similar performance as FG. Setting FGSEL to 01b for XOR has generally produced worse results.

Frequency-to-voltage converter and oscilloscope — Converting the FGOUT frequency to be represented by an analog voltage and sending the signal to a scope is useful. This allows observing spin-up and spin-down profiles, and any overshoot. Some flutter meters have an integrated frequency-to-voltage converter.

Computer — The computer connects to the PCB with a USB cable, and the GUI controls the MSP430G2553 microcontroller (MCU). This MSP430™ MCU can generate a clock, set high and low voltages on the control inputs, read the status outputs, and read and write to the DRV8308 registers using SPI. The bus isolation jumpers provide an easy way to disconnect the MCU from the DRV8308 if a different controller must be used.

A function generator (not shown) — Although the MCU can generate a clock with different duty cycles and frequencies, an external clock source attached to the P5 connector can be used instead. When using this connector, disable the MCU clock to prevent contention. Disabling the MCU clock can be done by removing the CLKIN bus isolation jumper, selecting the GUI option, *External Signal* in the first two tabs, or unchecking *Enable MCU CLK* on the third tab. Although the MCU clock is not quite as accurate as a function generator, the difference on flutter is negligible.

1.2 Configuration Jumpers

The DRV8308 board has three groups of configuration. [Table 1](#) lists the jumper configurations.

Table 1. Jumper Configuration

| Configuration | Jumper | Description |
|---------------|--------|---|
| HALL POWER | JP1 | Hall sensor power is 5 V or current |
| | JP2 | |
| DIFF HALL | JP3 | Differential or single-ended Hall sensors |
| SMODE | JP4 | SPI (BUI) or EEPROM mode |

1.2.1 HALL POWER Jumpers

Sensored BLDC motors typically use either Hall effect integrated circuits (ICs) or elements. Most ICs can use 5-V power, while elements typically have power pins that have an equivalent circuit of a resistor, and current must be limited to approximately 10 mA.

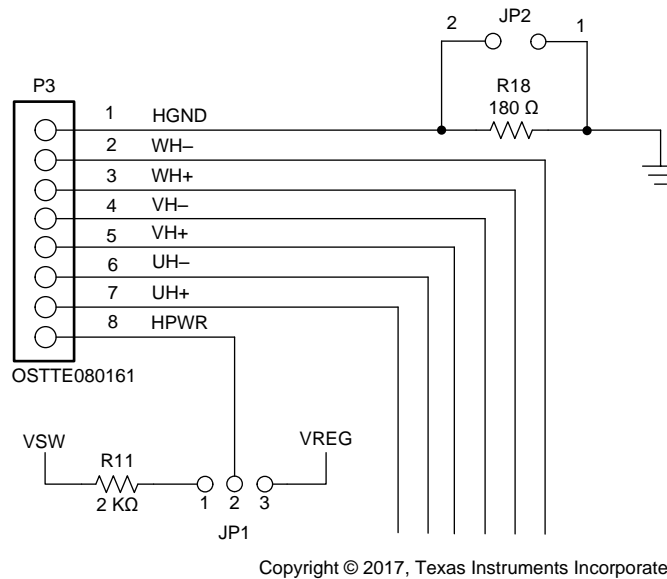

Figure 3. Hall PWR and GND Circuits

VREG is a regulated 5-V output from the DRV8308. By installing a jumper on pins 2-3 of JP1 and JP2, 5-V power is available on the P3 terminal block for powering Hall ICs. VREG is only powered when the DRV8308 is enabled unless the VREG_EN register is used.

VSW equals VM when the DRV8308 is enabled. By installing a jumper on pins 1-2 of JP1 and removing JP2, this circuit is available for Hall elements as shown in Figure 4.

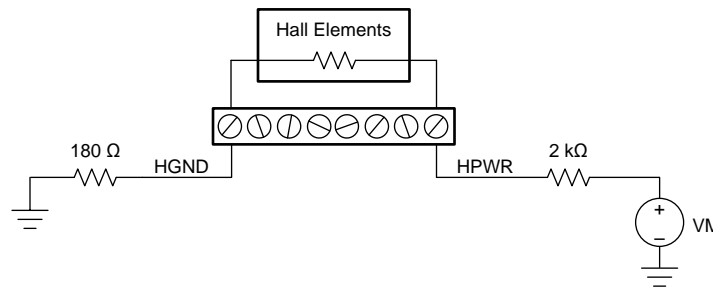

Figure 4. Circuit When Setting Hall Current to Power

The following is an example to calculate current: if $V_M = 24\text{ V}$, and 3 Hall elements that have a resistance of $400\ \Omega$ are connected in parallel, 10.4 mA will be supplied. Always refer to the Hall element specifications to understand the proper current. The purpose of the 180- Ω resistor is to bias-up the common mode voltage of Hall element differential signals because the DRV8308 requires a VICM voltage from 1.5 V to 3.5 V.

If unsure about whether to apply 5 V or the current-limiting circuit, measure the resistance between the Hall power and ground wires. If the resistance is less than 250 Ω , the current-limiting circuit should be used. Hall elements can be easily damaged if too much current is allowed.

1.2.2 DIFF HALL Jumper

Hall sensors output either a differential signal pair or a single-ended open-drain. Count the number of wires to determine which type of sensor the motor uses. A sensed BLDC typically has 3 phase wires, 2 Hall power wires, and 3 or 6 Hall signal wires. A total of 8 wires indicates a single-ended sensor. A total of 11 wires indicates a differential signal (excluding optional FG or TACH wires).

The DRV8308 has differential comparators on the Hall inputs, and they can also accommodate single-ended signals with the use of a few passive components. When using differential Hallsensors, directly connect the six Hall signals to the DRV8308 pins. When using single-ended Hallsensors, they require pullup resistors, and the negative (-) pins of the DRV8308 comparator pins should be biased with a middle voltage so that a single-ended swing on the positive (+) pin is detected as a differential voltage.

The JP3 jumper controls U7, an 8-line FET switch, and it decides when to connect the pullup resistors and middle voltage. Install JP3 when using differential Hallsensors. Uninstall JP3 when using single-ended Hallsensors and connect wires to the + terminals of P3.

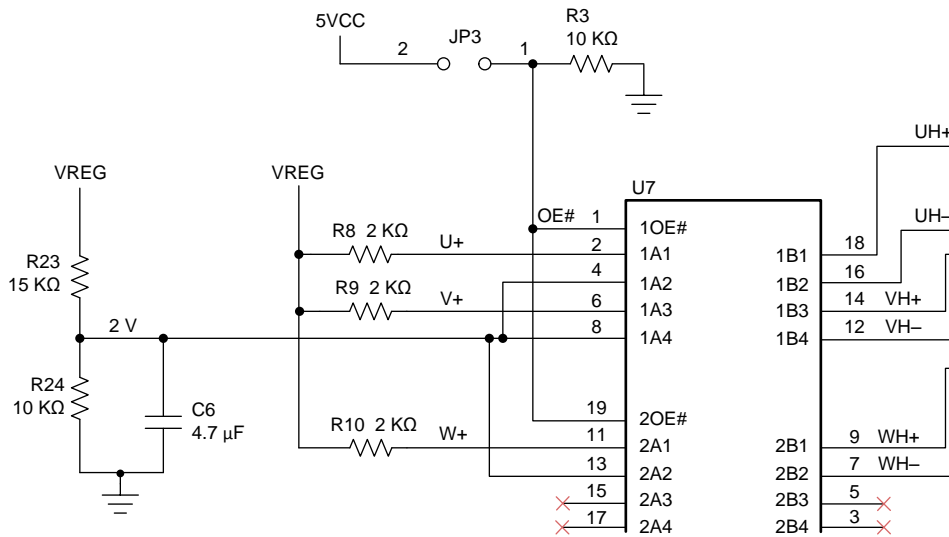

Figure 5. JP3 Control Whether 6 Controls are Made

1.2.3 SMODE Jumper

When the DRV8308 powers up, it checks if pin SMODE is high or low to decide whether to load register data from an external EEPROM, or from the internal nonvolatile one-time-programmable (OTP) memory. When the OTP method is used, the DRV8308 also accepts SPI commands to read and write registers.

Install the JP4 jumper when using the GUI and SPI. Uninstall JP4 when using an external EEPROM, and also install the JP5a, JP6a, JP7a, and JP8a jumpers and a 93C46B-compatible EEPROM into the DIP socket (U6).

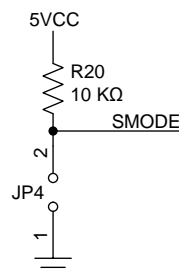

Figure 6. SMODE

2 GUI Software Installation

The following section explains the location and the procedure for properly installing the software.

NOTE: Ensure that no USB connections are made to the EVM until the installation is complete. The installer also installs the GUI Composer V2 Runtime along with the GUI installation.

2.1 System Requirements

The system requires:

- Supported operating system (OS): Windows 7 or higher (32 Bit or 64 Bit)
- Recommended RAM: 4 GB or higher
- Recommended CPU operating speed: 3.3 GHz or higher

2.2 Installation Procedure

Follow these steps to install the DRV8308 GUI:

- Step 1. Double click the *GUIComposerApp-0.1.0.setup-win_2.0.4* application file shown in [Figure 7](#) to launch the installation file.

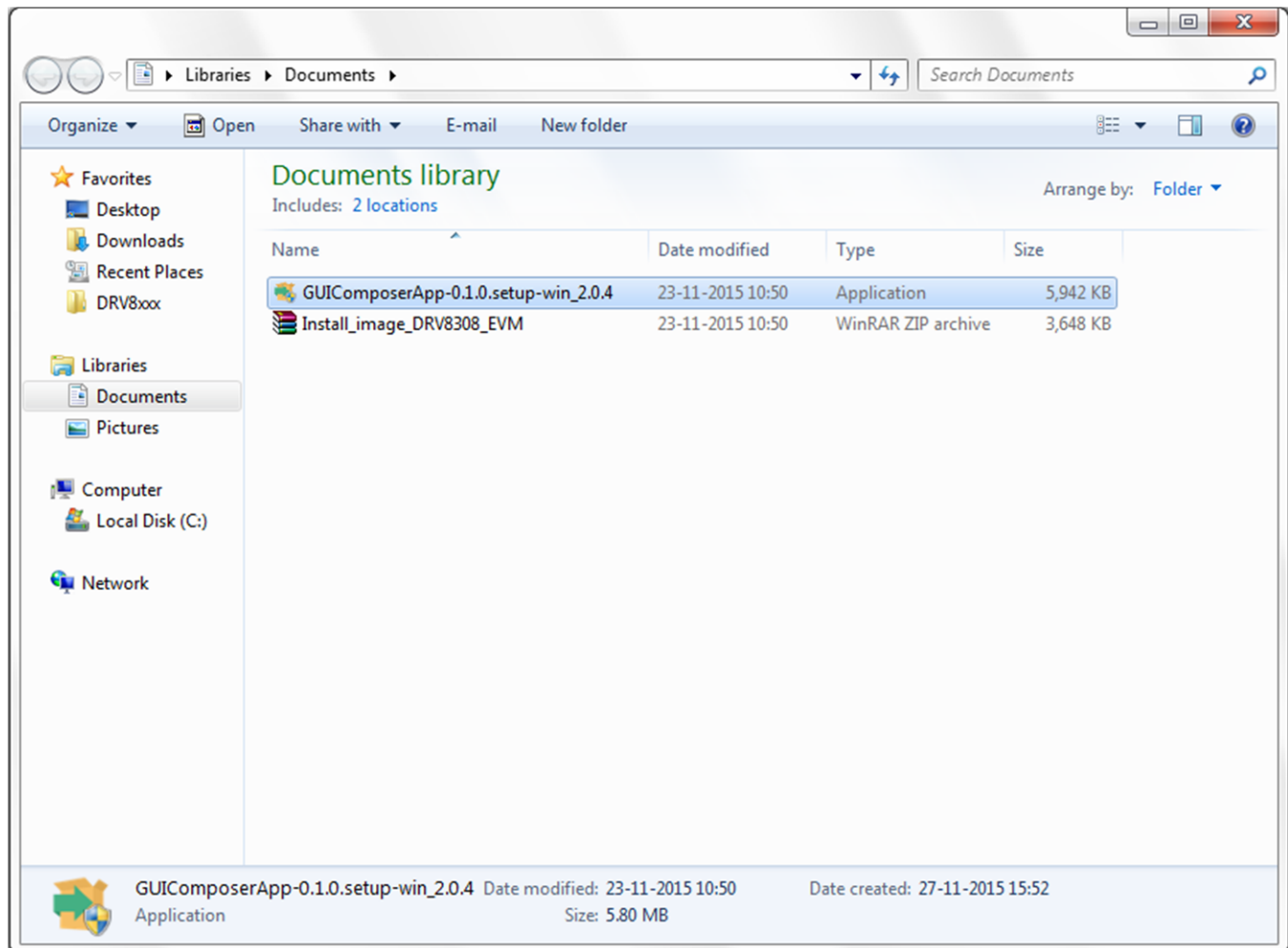

Figure 7. GUIComposerApp-0.1.0.setup-win_2.0.4

- Step 2. Click the *Next* button when the window in [Figure 8](#) appears which indicates installer initialization..

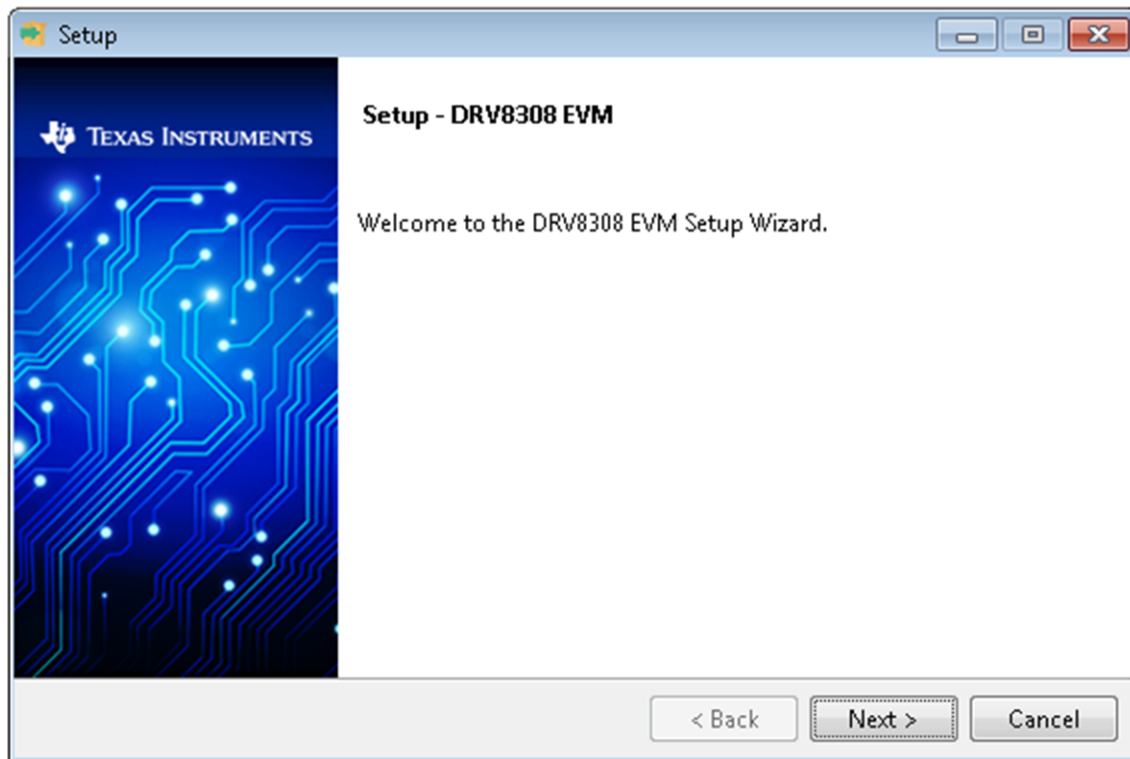

Figure 8. Installation Initialization

- Step 3. Read the license agreement for the DRV8308 EVM GUI.
- Step 4. Select the *I accept the agreement* radio button and click the *Next* button to proceed (see [Figure 9](#)).

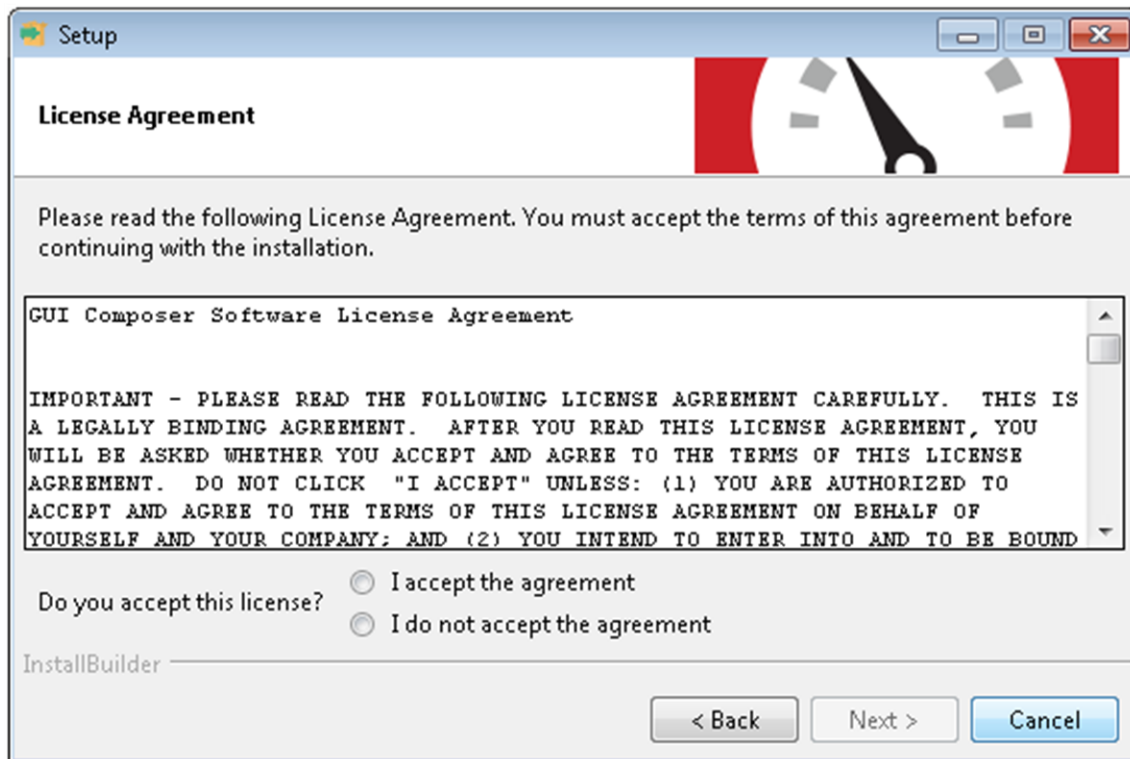

Figure 9. License Agreement

Step 5. Set the default directory for the GUI installation and click the *Next* button.

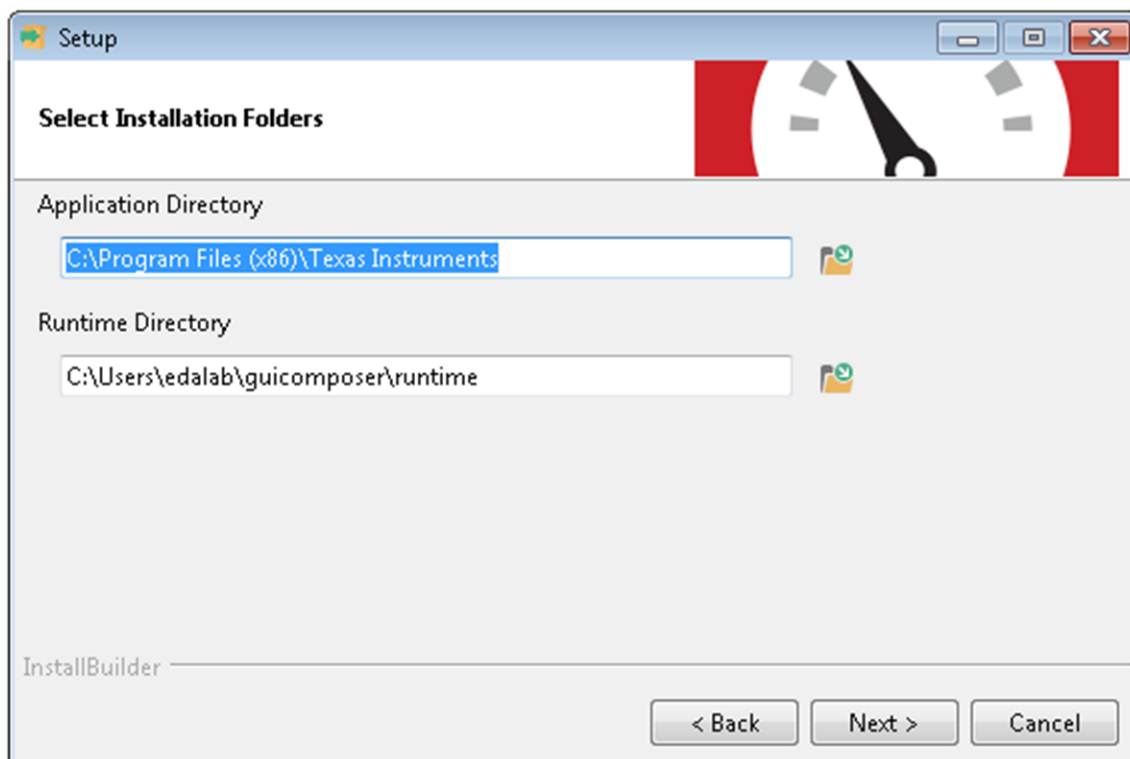

Figure 10. Installation Directory

NOTE: TI recommends keeping the default values as provided by the installer.

- Step 6. If the GUI Composer V2 Runtime is not available on the PC, the installer displays the window shown in [Figure 11](#). Either enter a location or download from the web and click the *Next* button.

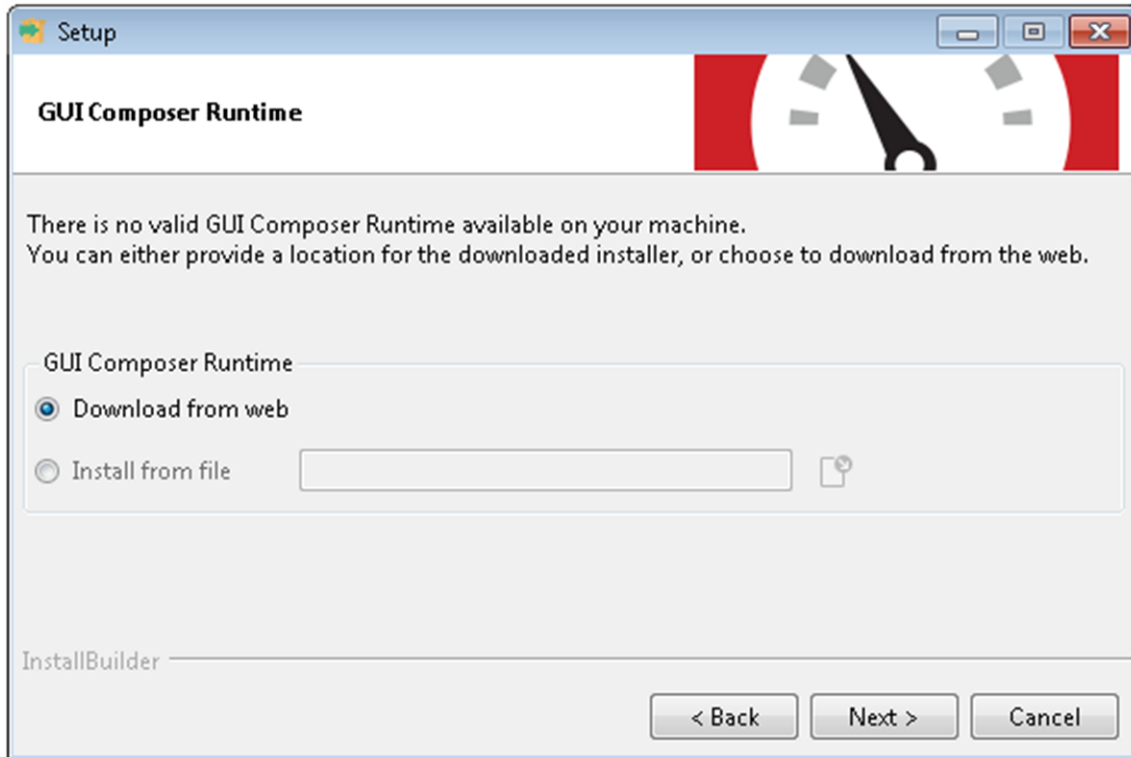

Figure 11. GUI Composer Runtime

- Step 7. If the GUI Composer Runtime downloaded from the web, it will then download the GUI Composer Runtime.

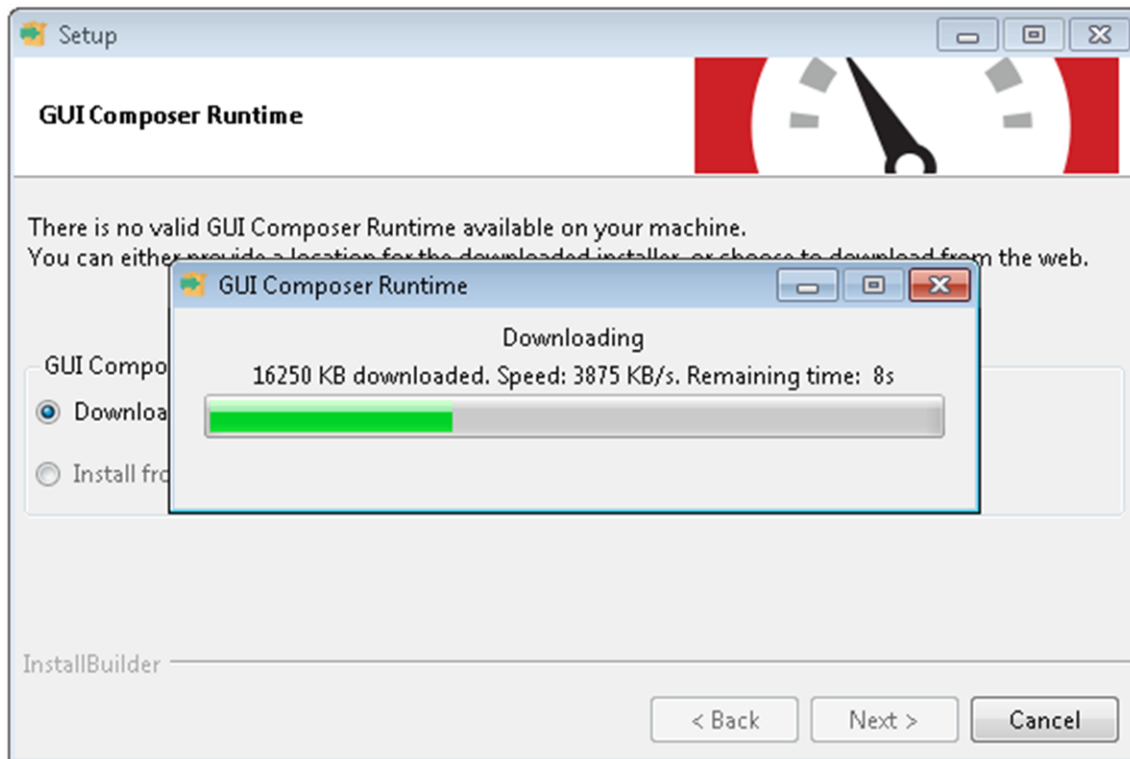

Figure 12. Downloading GUI Composer Runtime

Step 8. The installer extracts the GUI Composer component and continues with the installation as shown in [Figure 13](#).

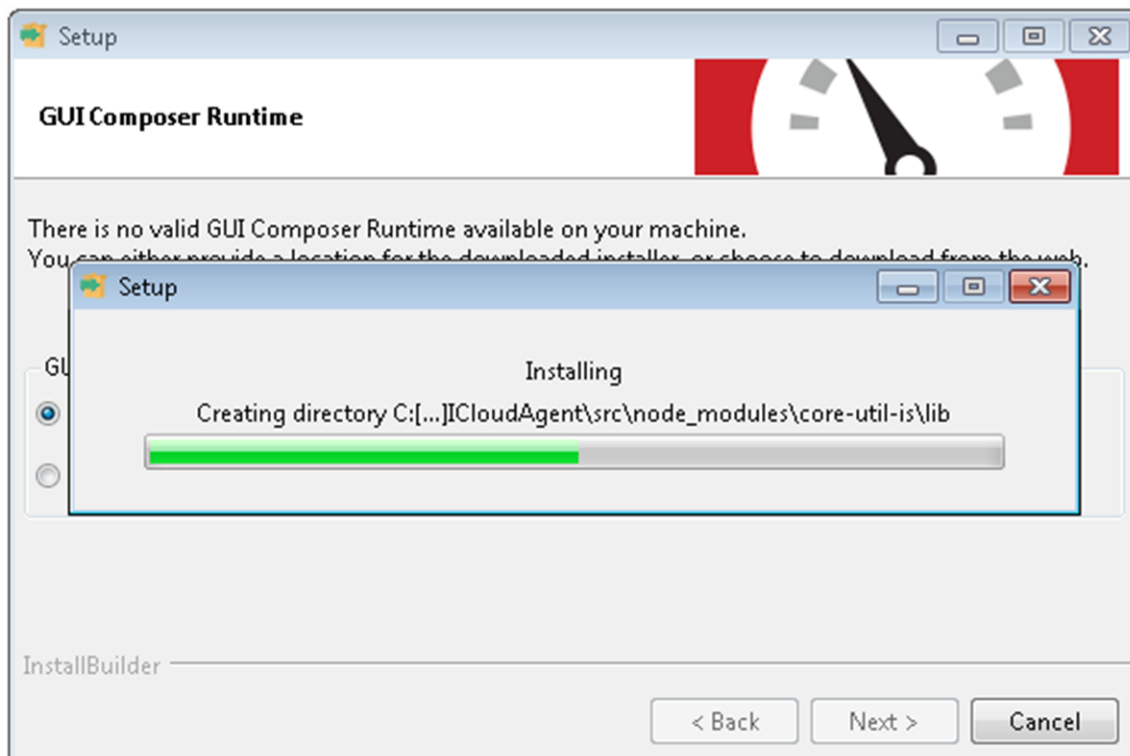

Figure 13. Self-Extraction of GUI Composer Runtime

Step 9. After the extraction of GUI Composer component, the installer continues with the setup installation as shown in [Figure 14](#).

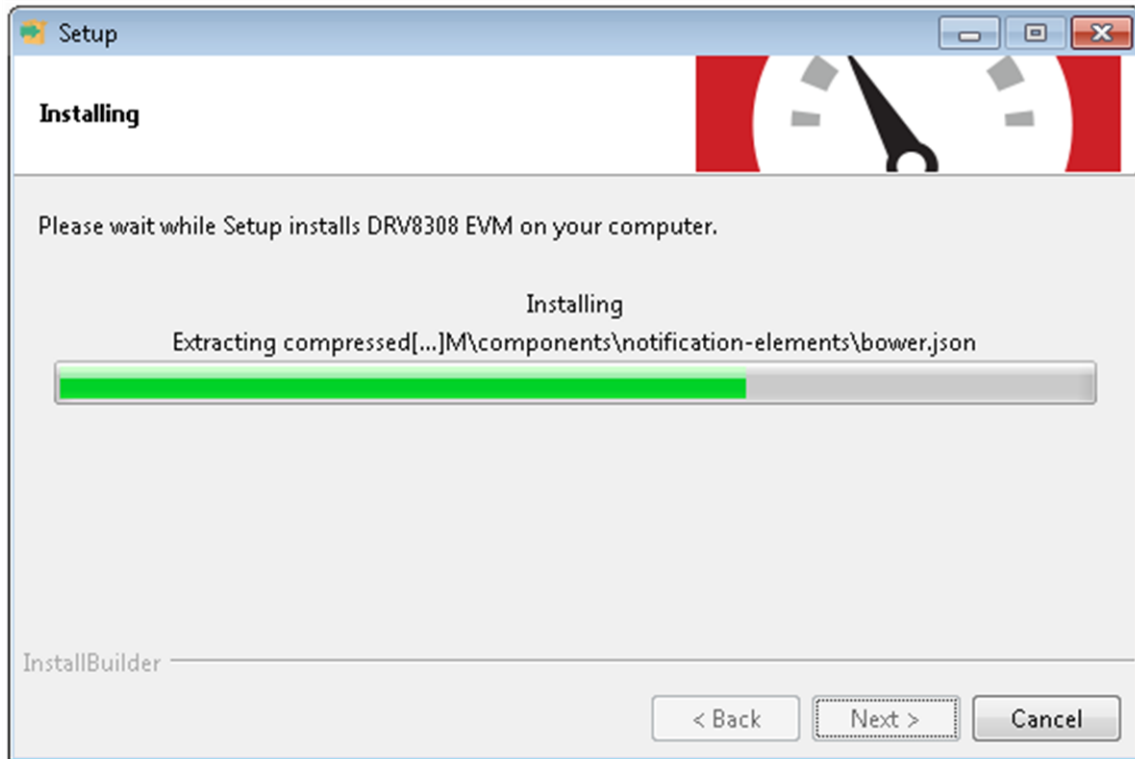

Figure 14. Installation in Progress

Step 10. The window in [Figure 15](#) displays when installation is complete. Click the *Finish* button to complete the installation.

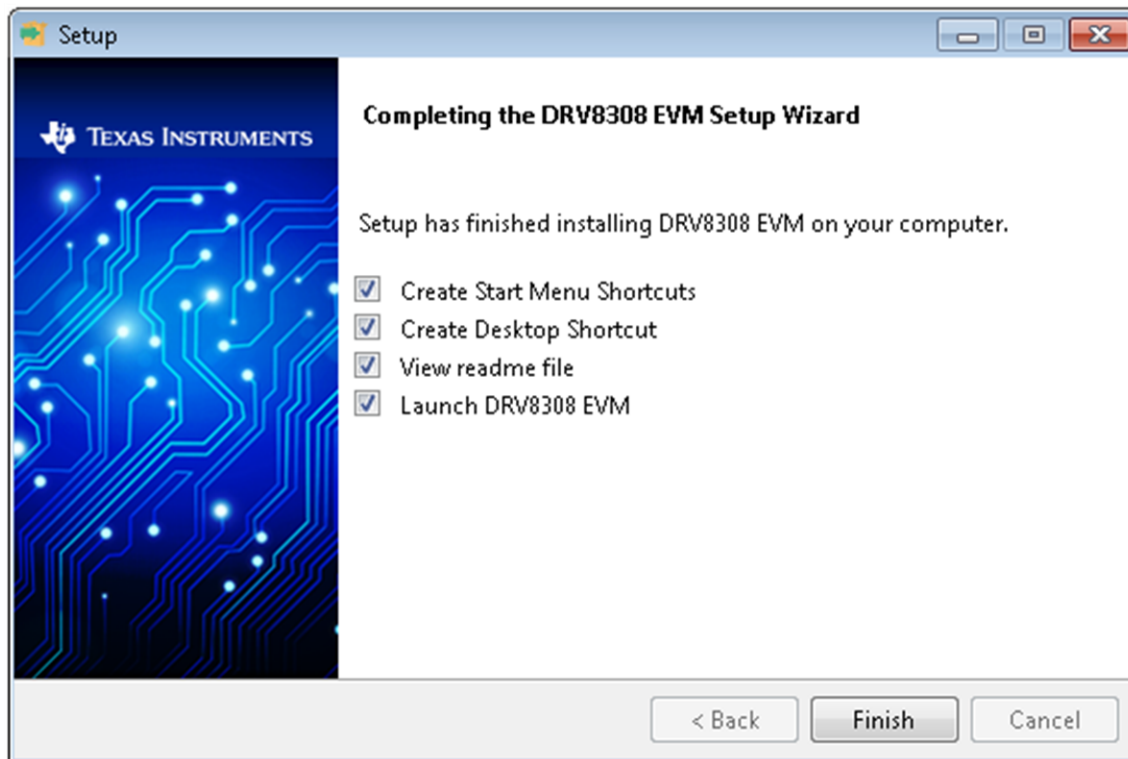

Figure 15. Setup Completion

Step 11. After clicking the *Finish* button, a readme window (see [Figure 16](#)) appears, displaying the link for LV 2014 RTE.

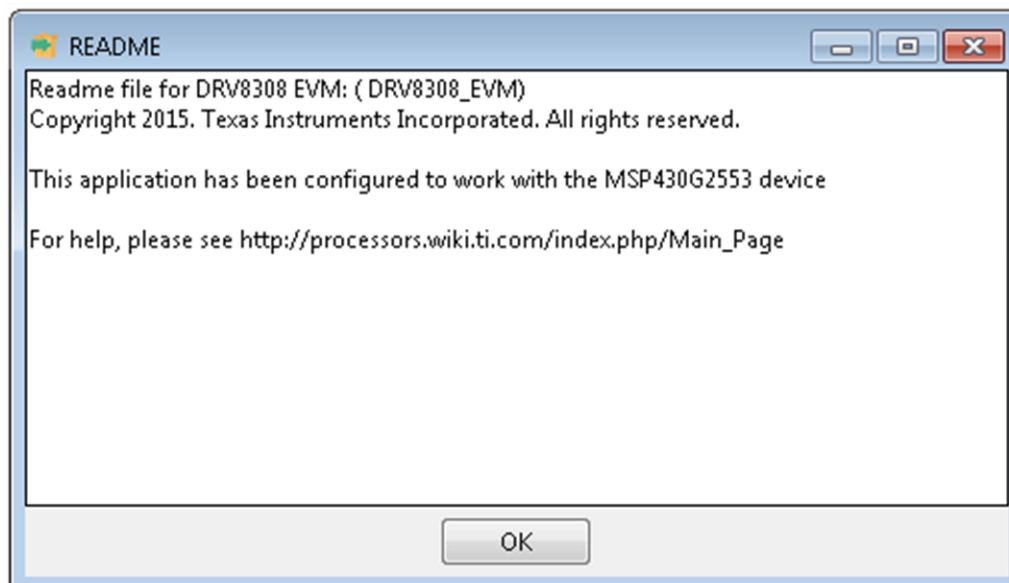

Figure 16. Readme Window

NOTE: The DRV8308 EVM GUI requires the GUI Composer Runtime V2 to be installed before the GUI is executed.

3 DRV8308 EVM GUI

3.1 Quick Guide to Spin With Open-Loop PWM

To spin the motor with open-loop PWM, follow these steps:

Step 1. Set the jumpers shown in [Figure 17](#).

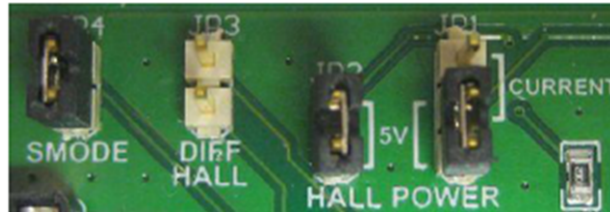

Figure 17. Jumpers

Step 2. Connect the USB cable between the board and the computer.

Step 3. Run the GUI.

Step 4. Wire the included motor to the terminal blocks as shown in [Figure 18](#).

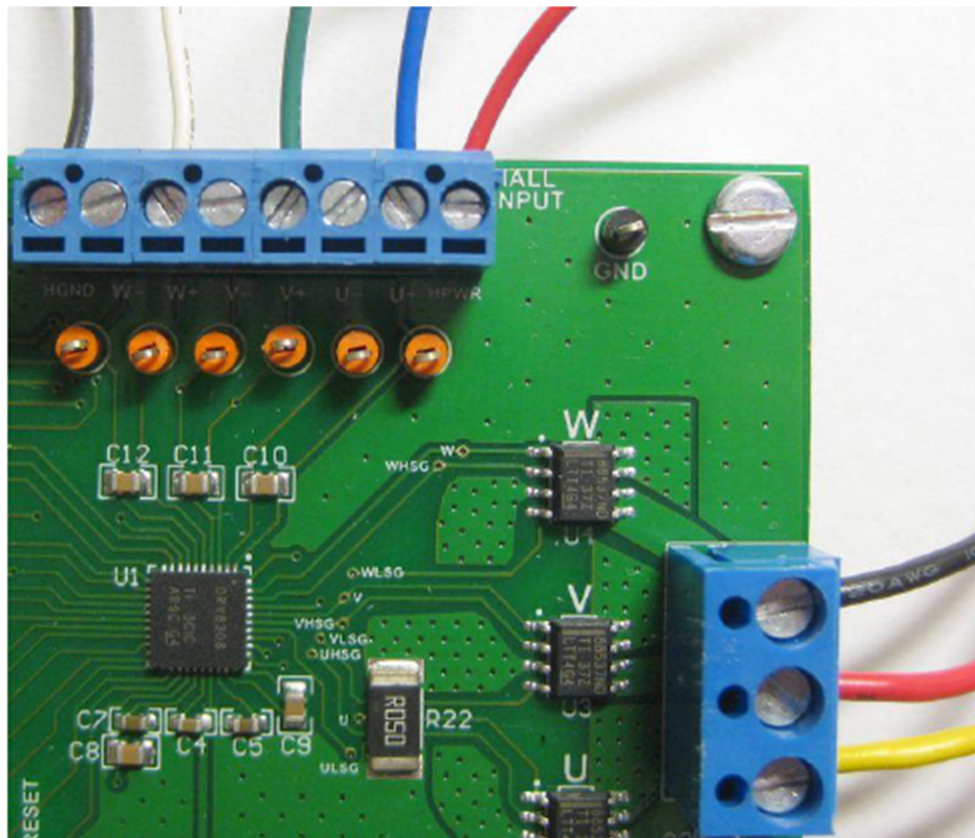

Figure 18. Wiring the Motor

Step 5. Connect the power supply to the board at the VM and GND terminals.

Step 6. Set the supply to 24 V with at least 1 A of current (higher current is better).

Step 7. Set the PWM duty cycle to 40% with the GUI loaded and no symbols.

Step 8. Click ENABLE to spin the motor.

Changes to the motor can be made as follows:

- To change from counter-clockwise to clockwise, click *DIR*.

- To change speed, use the duty cycle knob.
- To apply sinusoidal commutation, first change MOD120 from 2048 to 3970, and then select *180° Sine Commutation*.

NOTE: When MOD120 = 3970, a 2.1x factor is applied to the input duty cycle and therefore a 40% duty cycle input is treated as 84%.

- To use no clock and command speed from a register, select *PWM from SPEED Register*. Then the *SPEED* decimal value divided by 4095 is the input duty cycle.

3.2 Quick Guide to Spin With Speed Control

The second GUI tab operates the DRV8308 in clock frequency mode which uses the closed-loop speed-control system. Determining the correct frequency for the desired revolutions per minute (RPM) is important. For example, if FGSEL is set to 00b (Hall U), and the motor rotor has 8 magnet poles, four Hall U cycles occur per revolution and the RPM is $f_{CLKIN}/4 \times 60$. If FGSEL is set to 10b (FG), and 42 FG cycles occur per physical revolution, then the RPM is $f_{CLKIN}/42 \times 60$.

If unsure of the number of Hall U cycles of the motor per revolution, test the motor by disconnecting the three-phase wires, enabling the DRV8308 (to apply Hall power), probing the Hall U test point, and manually rotating the motor 360° while counting the number of cycles.

The included TelcoMotion motor has 8 magnetic poles. The following steps use a 100-Hz f_{CLKIN} and therefore the RPM is 1500.

- Step 1. Unclick *ENABLE* to stop the motor.
- Step 2. Select the second GUI tab and then:
 - Set AG_SETPT to 5 to 95 Hz.
 - Set LOOPGAIN to 200.
 - Set MOD120 to 3970.
 - Select CLK from MSP430.
- Step 3. Click *ENABLE* to spin the motor at exactly 1500 RPM. Connecting a scope probe to the FGOUT test point allows observation of the Hall U frequency. If the motor is loaded manually, an increase in the power-supply current occurs but the Hall U frequency stays the same because the speed is locked. If the motor can be stopped manually by squeezing hard enough, the power-supply current is probably set to 1 A or less.

3.3 The Third GUI tab

The last tab of the GUI shows all the device registers for the highest level of complexity and control. Changes made to this tab stay in effect when switching back to the first two tabs. By default, the *Auto Write* checkbox is enabled and therefore changes are written immediately through SPI.

The *Burn OTP Memory* button permanently writes the DRV8308 nonvolatile memory with the registers shown. *ENABLE* must be active for the burn to work. After writing the OTP, whenever the DRV8308 is powered up with SMODE set to low, the default registers will be what was programmed. To verify that the OTP was successfully written, uncheck *Auto Write*, cycle power to the EVM, type a random number into one of the register fields, click the *Read All* button, and verify that the random number is overwritten to the correct

(OTP) value.

3.4 If the GUI Has Slow Performance

Some computers exhibit slow performance when using the third GUI tab. Two common causes are:

- Too many ports in the *Device Manager*. From the computer, click the *Start* button and then *Control Panel* to find the system *Device Manager*. Under the *Ports* list, the port for the EVM is named *USB Serial Port*. If other ports are listed, try disabling them by right-clicking the port name and selecting *Disable* from the menu. Restart the GUI.
- Too many programs running in the background. Try closing all other programs and disk scanners.

3.5 Menu Options

This section lists the different GUI menu options.

3.5.1 File

The *File* menu contains the options as shown in [Figure 19](#). The options are defined as follows:

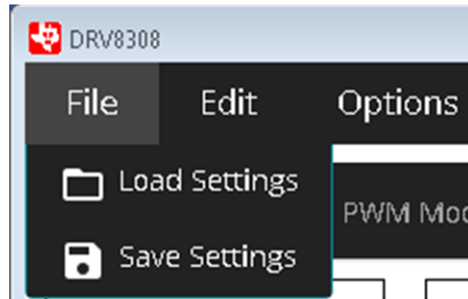

Figure 19. File Menu

Load settings — If this option is clicked, it loads the configuration file which was saved earlier to bring the device to a known state.

NOTE: Loading a configuration overwrites the existing data in the registers with the value specified in the .json file that is loaded.

Save settings — If this option is clicked, the current register configuration is saved into a file which can be loaded into the GUI in the future using the *Load* option.

3.5.2 Edit

The *Edit* menu contains the *Undo* and *Redo* options for changes done in the GUI (see [Figure 20](#)).



Figure 20. Edit Menu

3.5.3 Options

The *Options* menu contains the option to connect to the serial port and configure the serial port (see [Figure 21](#)).

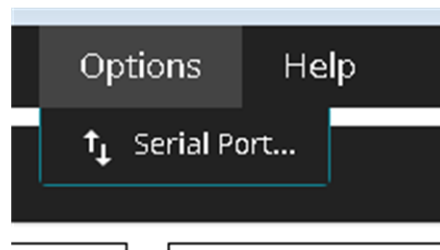

Figure 21. Options Menu

3.5.4 Help

The *Help* menu contains the options as shown in [Figure 22](#). The options are defined as follows:

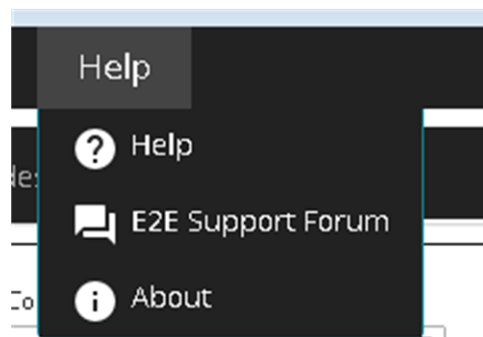

Figure 22. Help Menu

Help — The *Help* option connects the GUI to the E2E™ online community.

E2E™ Support Forum— The *Help* connects to the E2E™ forum.

About— The *About* option provides information about the GUI as shown in [Figure 23](#).

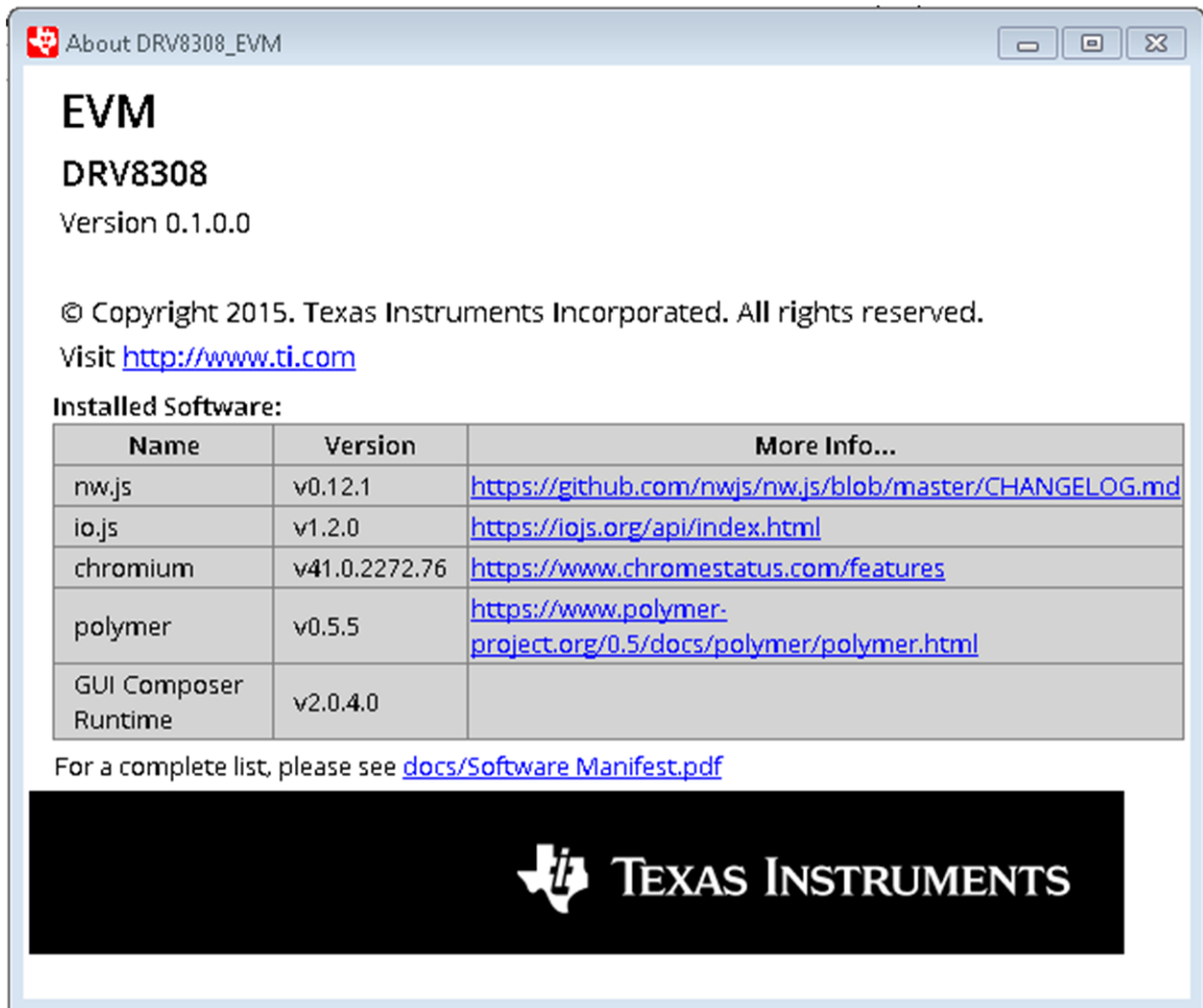

Figure 23. About Page

4 Tuning the Speed-Control System

The DRV8308 clock frequency mode for speed control performs best when the device registers are tuned for the motor, inertia, speed, and load torque of a particular system.

4.1 Key Registers

This first set of registers must be configured correctly:

MOD120 — Always set this register to 3970.

SPEED — This register is the open-loop gain during spin-up before LOCKn goes low. This register must be set high enough to reach the commanded RPM.

AUTOGAIN — When enabled, the DRV8308 scales LOOPGAIN with RPM because more gain is required for more speed. AUTOGAIN is a valuable feature and should generally be left enabled. Then $\text{ScaledGain} = \text{LOOPGAIN} \times f_{\text{CLKIN}} / \text{AG_SETPT}$.

AG_SETPT — This set point effectively sets the range for AUTOGAIN. Use the setting that is closest to see the DRV8308 data sheet register descriptions (fCLKIN).

AUTOADV — When enabled, the DRV8308 aggressively scales ADVANCE with RPM: Scaled Advance = $ADVANCE \times f_{HALLU}/AA_SETPT$. Without this setting, ADVANCE already scales with speed because each value shifts timing by 0.1% of the Hall U period. Disable AUTOADV initially. Then, when the system is well-tuned, experiment with AUTOADV to potentially improve performance.

AA_SETPT— This register only applies when AUTOADV is enabled. Use the setting that is closest to the frequency of Hall U.

IDRIVE — This register sets the predriver output current and directly controls the external FET VGS turnon time. Unless high-current FETs are used, lower values are generally better to minimize switching noise.

FGSEL — If an FG sense trace is not used, setting FGSEL to 0 (HALL_U) is generally best.

These registers should be tuned for a particular system:

ADVANCE — This register adjusts the timing shift between when the DRV8308 receives Hall signals and commutation. While a motor is running, the ADVANCE register can be modified in real-time (if AUTOADV is disabled). The difference in power-supply current occurs instantly. A lower current is generally better, but flutter performance can be a tradeoff of higher current.

LOOPGAIN — This gain primarily affects the maximum RPM, maximum torque, and startup-speed overshoot. If the gain is too low, the motor does not spin up to the commanded RPM or the torque capability may be limited. If the gain is too high, the motor speed overshoots at first.

SPDGAIN — This gain affects how aggressively error is compensated. If the gain is too high, the speed oscillates around the target speed. If the gain is too low, flutter may be higher.

FILK1 — This register sets the Pole1 frequency.

FILK2 — This register sets the Zero1 frequency.

COMK1 — This register sets the Pole2 frequency.

COMK2 — This register sets the Zero2 frequency.

4.2 Tuning Process

Tuning a motor system is a trial-and-error process. The following steps are a general guide. The GUI loads with the default register values that attempt to have reasonable filter settings.

1. Use the first tab to run the motor in PWM mode. Trying different wire connections and HALLPOL to achieve a consistent motor spin may be necessary. After that, while spinning the motor, change the ADVANCE register and find the value that causes the lowest power-supply current and audible motor noise. Then stop the motor by bringing ENABLE low.
2. Determine the appropriate clock frequency, f_{CLKIN} . Select the third GUI tab, and:
 - Set AG_SETPT closest to the target f_{CLKIN} .
 - Set MOD120 to 3970.
 - Set SPEED to 4000.
3. Turn on the clock, and start the motor with ENABLE. If the motor spins very roughly,
 - Try reducing or increasing f_{CLKIN} to find a practical case as a baseline reference.
 - Try changing the filters (FILK1, FILK2, COMK1, or COMK2) with different combinations in increments of 150. Spend some time to find good values.
 - Try increasing SPDGAIN and LOOPGAIN.
4. By now the motor should spin smoothly, but the frequency of the signal on FGOUT might not match f_{CLKIN} . If the two frequencies do not match, the speed is not locked. Many times that can be fixed by increasing LOOPGAIN or SPEED.
5. Now the motor should be spinning with the FGOUT frequency matching f_{CLKIN} . If the motor was loaded manually, it should maintain the same RPM and FGOUT frequency. To increase the load capability, try increasing LOOPGAIN or decreasing the value of the RSENSE resistor to allow more motor current.

At this point, determining the minimum *total gain* required to reach the target RPM and torque drive is useful. To do find this value, continue decreasing LOOPGAIN and toggling ENABLE to find the LOOPGAIN that prevents f_{FGOUT} from reaching f_{CLKIN} . The filter registers affect pole and zero frequencies of the control system. Filter registers also affect gain in the same way as LOOPGAIN, where $Total\ gain = LOOPGAIN \times (2 \times FILK2/FILK1) \times (0.5 \times COMK2/COMK1)$.

Inside the downloaded board files and software, open the file, \Application\Filter calculator.xls. Enter the filter values and LOOPGAIN into the green cells and review the *Total gain*. This value is the minimum gain required by the system to reach the commanded RPM.

In future trials, changing the filters (to improve flutter and dynamic performance) will also change total gain, and the calculator should be used to determine the correct value for LOOPGAIN to keep the total gain at least 20% above the minimum. Being 1.5x to 3x above the minimum value is often acceptable and the first consequence of having too much total gain is that start-up speed can overshoot..

NOTE: More gain is required to drive more torque

6. To optimize flutter performance, vary ADVANCE, SPDGAIN, and many combinations of the FILK1, FILK2, COMK1, and COMK2 filters. These filter settings can be changed in real-time while the motor is spinning, but the new *total gain* is only updated when the motor restarts (technically when LOCKn transitions to low if AUTOGAIN is enabled).

In many cases, setting Pole1 to a much higher frequency than the others and setting Zero2 to Pole2 to a frequency band between Zero1 and Pole1 works well. Try many combinations to find the correct settings. Feel free to post any questions to the TI E2E Forum online.

NOTE: If additional assistance is needed, post questions to the motor drivers section of the [TI E2E Support Community](#).

Revision History

NOTE: Page numbers for previous revisions may differ from page numbers in the current version.

| Changes from E Revision (May 2015) to F Revision | Page |
|---|-------------|
| • Changed pass to FGOUT | 4 |
| • Added Improperly-tuned DRV8308 register settings when in Clock Frequency Mode. | 4 |
| • Added (not shown) | 5 |
| • no symbols..... | 15 |
| • Changed DIR | 15 |
| • duty cycle knob..... | 16 |
| • MOD120 | 16 |
| • Changed PWM from SPEED Register | 16 |
| • Changed The following steps | 16 |
| • Added test point..... | 16 |
| • Added closest to see the DRV8308 data sheet register descriptions fCLKIN) | 19 |

STANDARD TERMS FOR EVALUATION MODULES

1. *Delivery:* TI delivers TI evaluation boards, kits, or modules, including any accompanying demonstration software, components, and/or documentation which may be provided together or separately (collectively, an "EVM" or "EVMs") to the User ("User") in accordance with the terms set forth herein. User's acceptance of the EVM is expressly subject to the following terms.
 - 1.1 EVMs are intended solely for product or software developers for use in a research and development setting to facilitate feasibility evaluation, experimentation, or scientific analysis of TI semiconductor products. EVMs have no direct function and are not finished products. EVMs shall not be directly or indirectly assembled as a part or subassembly in any finished product. For clarification, any software or software tools provided with the EVM ("Software") shall not be subject to the terms and conditions set forth herein but rather shall be subject to the applicable terms that accompany such Software
 - 1.2 EVMs are not intended for consumer or household use. EVMs may not be sold, sublicensed, leased, rented, loaned, assigned, or otherwise distributed for commercial purposes by Users, in whole or in part, or used in any finished product or production system.
2. *Limited Warranty and Related Remedies/Disclaimers:*
 - 2.1 These terms do not apply to Software. The warranty, if any, for Software is covered in the applicable Software License Agreement.
 - 2.2 TI warrants that the TI EVM will conform to TI's published specifications for ninety (90) days after the date TI delivers such EVM to User. Notwithstanding the foregoing, TI shall not be liable for a nonconforming EVM if (a) the nonconformity was caused by neglect, misuse or mistreatment by an entity other than TI, including improper installation or testing, or for any EVMs that have been altered or modified in any way by an entity other than TI, (b) the nonconformity resulted from User's design, specifications or instructions for such EVMs or improper system design, or (c) User has not paid on time. Testing and other quality control techniques are used to the extent TI deems necessary. TI does not test all parameters of each EVM. User's claims against TI under this Section 2 are void if User fails to notify TI of any apparent defects in the EVMs within ten (10) business days after delivery, or of any hidden defects with ten (10) business days after the defect has been detected.
 - 2.3 TI's sole liability shall be at its option to repair or replace EVMs that fail to conform to the warranty set forth above, or credit User's account for such EVM. TI's liability under this warranty shall be limited to EVMs that are returned during the warranty period to the address designated by TI and that are determined by TI not to conform to such warranty. If TI elects to repair or replace such EVM, TI shall have a reasonable time to repair such EVM or provide replacements. Repaired EVMs shall be warranted for the remainder of the original warranty period. Replaced EVMs shall be warranted for a new full ninety (90) day warranty period.
3. *Regulatory Notices:*
 - 3.1 *United States*
 - 3.1.1 *Notice applicable to EVMs not FCC-Approved:*

FCC NOTICE: This kit is designed to allow product developers to evaluate electronic components, circuitry, or software associated with the kit to determine whether to incorporate such items in a finished product and software developers to write software applications for use with the end product. This kit is not a finished product and when assembled may not be resold or otherwise marketed unless all required FCC equipment authorizations are first obtained. Operation is subject to the condition that this product not cause harmful interference to licensed radio stations and that this product accept harmful interference. Unless the assembled kit is designed to operate under part 15, part 18 or part 95 of this chapter, the operator of the kit must operate under the authority of an FCC license holder or must secure an experimental authorization under part 5 of this chapter.
 - 3.1.2 *For EVMs annotated as FCC – FEDERAL COMMUNICATIONS COMMISSION Part 15 Compliant:*

CAUTION

This device complies with part 15 of the FCC Rules. Operation is subject to the following two conditions: (1) This device may not cause harmful interference, and (2) this device must accept any interference received, including interference that may cause undesired operation.

Changes or modifications not expressly approved by the party responsible for compliance could void the user's authority to operate the equipment.

FCC Interference Statement for Class A EVM devices

NOTE: This equipment has been tested and found to comply with the limits for a Class A digital device, pursuant to part 15 of the FCC Rules. These limits are designed to provide reasonable protection against harmful interference when the equipment is operated in a commercial environment. This equipment generates, uses, and can radiate radio frequency energy and, if not installed and used in accordance with the instruction manual, may cause harmful interference to radio communications. Operation of this equipment in a residential area is likely to cause harmful interference in which case the user will be required to correct the interference at his own expense.

FCC Interference Statement for Class B EVM devices

NOTE: This equipment has been tested and found to comply with the limits for a Class B digital device, pursuant to part 15 of the FCC Rules. These limits are designed to provide reasonable protection against harmful interference in a residential installation. This equipment generates, uses and can radiate radio frequency energy and, if not installed and used in accordance with the instructions, may cause harmful interference to radio communications. However, there is no guarantee that interference will not occur in a particular installation. If this equipment does cause harmful interference to radio or television reception, which can be determined by turning the equipment off and on, the user is encouraged to try to correct the interference by one or more of the following measures:

- Reorient or relocate the receiving antenna.
- Increase the separation between the equipment and receiver.
- Connect the equipment into an outlet on a circuit different from that to which the receiver is connected.
- Consult the dealer or an experienced radio/TV technician for help.

3.2 Canada

3.2.1 For EVMs issued with an Industry Canada Certificate of Conformance to RSS-210 or RSS-247

Concerning EVMs Including Radio Transmitters:

This device complies with Industry Canada license-exempt RSSs. Operation is subject to the following two conditions:

(1) this device may not cause interference, and (2) this device must accept any interference, including interference that may cause undesired operation of the device.

Concernant les EVMs avec appareils radio:

Le présent appareil est conforme aux CNR d'Industrie Canada applicables aux appareils radio exempts de licence. L'exploitation est autorisée aux deux conditions suivantes: (1) l'appareil ne doit pas produire de brouillage, et (2) l'utilisateur de l'appareil doit accepter tout brouillage radioélectrique subi, même si le brouillage est susceptible d'en compromettre le fonctionnement.

Concerning EVMs Including Detachable Antennas:

Under Industry Canada regulations, this radio transmitter may only operate using an antenna of a type and maximum (or lesser) gain approved for the transmitter by Industry Canada. To reduce potential radio interference to other users, the antenna type and its gain should be so chosen that the equivalent isotropically radiated power (e.i.r.p.) is not more than that necessary for successful communication. This radio transmitter has been approved by Industry Canada to operate with the antenna types listed in the user guide with the maximum permissible gain and required antenna impedance for each antenna type indicated. Antenna types not included in this list, having a gain greater than the maximum gain indicated for that type, are strictly prohibited for use with this device.

Concernant les EVMs avec antennes détachables

Conformément à la réglementation d'Industrie Canada, le présent émetteur radio peut fonctionner avec une antenne d'un type et d'un gain maximal (ou inférieur) approuvé pour l'émetteur par Industrie Canada. Dans le but de réduire les risques de brouillage radioélectrique à l'intention des autres utilisateurs, il faut choisir le type d'antenne et son gain de sorte que la puissance isotrope rayonnée équivalente (p.i.r.e.) ne dépasse pas l'intensité nécessaire à l'établissement d'une communication satisfaisante. Le présent émetteur radio a été approuvé par Industrie Canada pour fonctionner avec les types d'antenne énumérés dans le manuel d'usage et ayant un gain admissible maximal et l'impédance requise pour chaque type d'antenne. Les types d'antenne non inclus dans cette liste, ou dont le gain est supérieur au gain maximal indiqué, sont strictement interdits pour l'exploitation de l'émetteur.

3.3 Japan

3.3.1 *Notice for EVMs delivered in Japan:* Please see http://www.tij.co.jp/lstds/ti_ja/general/eStore/notice_01.page 日本国内に輸入される評価用キット、ボードについては、次のところをご覧ください。
http://www.tij.co.jp/lstds/ti_ja/general/eStore/notice_01.page

3.3.2 *Notice for Users of EVMs Considered "Radio Frequency Products" in Japan:* EVMs entering Japan may not be certified by TI as conforming to Technical Regulations of Radio Law of Japan.

If User uses EVMs in Japan, not certified to Technical Regulations of Radio Law of Japan, User is required to follow the instructions set forth by Radio Law of Japan, which includes, but is not limited to, the instructions below with respect to EVMs (which for the avoidance of doubt are stated strictly for convenience and should be verified by User):

1. Use EVMs in a shielded room or any other test facility as defined in the notification #173 issued by Ministry of Internal Affairs and Communications on March 28, 2006, based on Sub-section 1.1 of Article 6 of the Ministry's Rule for Enforcement of Radio Law of Japan,
2. Use EVMs only after User obtains the license of Test Radio Station as provided in Radio Law of Japan with respect to EVMs, or
3. Use of EVMs only after User obtains the Technical Regulations Conformity Certification as provided in Radio Law of Japan with respect to EVMs. Also, do not transfer EVMs, unless User gives the same notice above to the transferee. Please note that if User does not follow the instructions above, User will be subject to penalties of Radio Law of Japan.

【無線電波を送信する製品の開発キットをお使いになる際の注意事項】 開発キットの中には技術基準適合証明を受けていないものがあります。技術適合証明を受けていないものご使用に際しては、電波法遵守のため、以下のいずれかの措置を取っていただく必要がありますのでご注意ください。

1. 電波法施行規則第6条第1項第1号に基づく平成18年3月28日総務省告示第173号で定められた電波暗室等の試験設備でご使用いただく。
2. 実験局の免許を取得後ご使用いただく。
3. 技術基準適合証明を取得後ご使用いただく。

なお、本製品は、上記の「ご使用にあたっての注意」を譲渡先、移転先に通知しない限り、譲渡、移転できないものとします。

上記を遵守頂けない場合は、電波法の罰則が適用される可能性があることをご留意ください。日本テキサス・インスツルメンツ株式会社
東京都新宿区西新宿 6 丁目 2 4 番 1 号
西新宿三井ビル

3.3.3 *Notice for EVMs for Power Line Communication:* Please see http://www.tij.co.jp/lstds/ti_ja/general/eStore/notice_02.page
電力線搬送波通信についての開発キットをお使いになる際の注意事項については、次のところをご覧ください。 http://www.tij.co.jp/lstds/ti_ja/general/eStore/notice_02.page

3.4 *European Union*

3.4.1 *For EVMs subject to EU Directive 2014/30/EU (Electromagnetic Compatibility Directive):*

This is a class A product intended for use in environments other than domestic environments that are connected to a low-voltage power-supply network that supplies buildings used for domestic purposes. In a domestic environment this product may cause radio interference in which case the user may be required to take adequate measures.

4 *EVM Use Restrictions and Warnings:*

4.1 EVMS ARE NOT FOR USE IN FUNCTIONAL SAFETY AND/OR SAFETY CRITICAL EVALUATIONS, INCLUDING BUT NOT LIMITED TO EVALUATIONS OF LIFE SUPPORT APPLICATIONS.

4.2 User must read and apply the user guide and other available documentation provided by TI regarding the EVM prior to handling or using the EVM, including without limitation any warning or restriction notices. The notices contain important safety information related to, for example, temperatures and voltages.

4.3 *Safety-Related Warnings and Restrictions:*

4.3.1 User shall operate the EVM within TI's recommended specifications and environmental considerations stated in the user guide, other available documentation provided by TI, and any other applicable requirements and employ reasonable and customary safeguards. Exceeding the specified performance ratings and specifications (including but not limited to input and output voltage, current, power, and environmental ranges) for the EVM may cause personal injury or death, or property damage. If there are questions concerning performance ratings and specifications, User should contact a TI field representative prior to connecting interface electronics including input power and intended loads. Any loads applied outside of the specified output range may also result in unintended and/or inaccurate operation and/or possible permanent damage to the EVM and/or interface electronics. Please consult the EVM user guide prior to connecting any load to the EVM output. If there is uncertainty as to the load specification, please contact a TI field representative. During normal operation, even with the inputs and outputs kept within the specified allowable ranges, some circuit components may have elevated case temperatures. These components include but are not limited to linear regulators, switching transistors, pass transistors, current sense resistors, and heat sinks, which can be identified using the information in the associated documentation. When working with the EVM, please be aware that the EVM may become very warm.

4.3.2 EVMs are intended solely for use by technically qualified, professional electronics experts who are familiar with the dangers and application risks associated with handling electrical mechanical components, systems, and subsystems. User assumes all responsibility and liability for proper and safe handling and use of the EVM by User or its employees, affiliates, contractors or designees. User assumes all responsibility and liability to ensure that any interfaces (electronic and/or mechanical) between the EVM and any human body are designed with suitable isolation and means to safely limit accessible leakage currents to minimize the risk of electrical shock hazard. User assumes all responsibility and liability for any improper or unsafe handling or use of the EVM by User or its employees, affiliates, contractors or designees.

4.4 User assumes all responsibility and liability to determine whether the EVM is subject to any applicable international, federal, state, or local laws and regulations related to User's handling and use of the EVM and, if applicable, User assumes all responsibility and liability for compliance in all respects with such laws and regulations. User assumes all responsibility and liability for proper disposal and recycling of the EVM consistent with all applicable international, federal, state, and local requirements.

5. *Accuracy of Information:* To the extent TI provides information on the availability and function of EVMs, TI attempts to be as accurate as possible. However, TI does not warrant the accuracy of EVM descriptions, EVM availability or other information on its websites as accurate, complete, reliable, current, or error-free.

6. *Disclaimers:*

6.1 EXCEPT AS SET FORTH ABOVE, EVMS AND ANY MATERIALS PROVIDED WITH THE EVM (INCLUDING, BUT NOT LIMITED TO, REFERENCE DESIGNS AND THE DESIGN OF THE EVM ITSELF) ARE PROVIDED "AS IS" AND "WITH ALL FAULTS." TI DISCLAIMS ALL OTHER WARRANTIES, EXPRESS OR IMPLIED, REGARDING SUCH ITEMS, INCLUDING BUT NOT LIMITED TO ANY EPIDEMIC FAILURE WARRANTY OR IMPLIED WARRANTIES OF MERCHANTABILITY OR FITNESS FOR A PARTICULAR PURPOSE OR NON-INFRINGEMENT OF ANY THIRD PARTY PATENTS, COPYRIGHTS, TRADE SECRETS OR OTHER INTELLECTUAL PROPERTY RIGHTS.

6.2 EXCEPT FOR THE LIMITED RIGHT TO USE THE EVM SET FORTH HEREIN, NOTHING IN THESE TERMS SHALL BE CONSTRUED AS GRANTING OR CONFERRING ANY RIGHTS BY LICENSE, PATENT, OR ANY OTHER INDUSTRIAL OR INTELLECTUAL PROPERTY RIGHT OF TI, ITS SUPPLIERS/LICENSORS OR ANY OTHER THIRD PARTY, TO USE THE EVM IN ANY FINISHED END-USER OR READY-TO-USE FINAL PRODUCT, OR FOR ANY INVENTION, DISCOVERY OR IMPROVEMENT, REGARDLESS OF WHEN MADE, CONCEIVED OR ACQUIRED.

7. *USER'S INDEMNITY OBLIGATIONS AND REPRESENTATIONS.* USER WILL DEFEND, INDEMNIFY AND HOLD TI, ITS LICENSORS AND THEIR REPRESENTATIVES HARMLESS FROM AND AGAINST ANY AND ALL CLAIMS, DAMAGES, LOSSES, EXPENSES, COSTS AND LIABILITIES (COLLECTIVELY, "CLAIMS") ARISING OUT OF OR IN CONNECTION WITH ANY HANDLING OR USE OF THE EVM THAT IS NOT IN ACCORDANCE WITH THESE TERMS. THIS OBLIGATION SHALL APPLY WHETHER CLAIMS ARISE UNDER STATUTE, REGULATION, OR THE LAW OF TORT, CONTRACT OR ANY OTHER LEGAL THEORY, AND EVEN IF THE EVM FAILS TO PERFORM AS DESCRIBED OR EXPECTED.

8. *Limitations on Damages and Liability:*

8.1 *General Limitations.* IN NO EVENT SHALL TI BE LIABLE FOR ANY SPECIAL, COLLATERAL, INDIRECT, PUNITIVE, INCIDENTAL, CONSEQUENTIAL, OR EXEMPLARY DAMAGES IN CONNECTION WITH OR ARISING OUT OF THESE TERMS OR THE USE OF THE EVMS , REGARDLESS OF WHETHER TI HAS BEEN ADVISED OF THE POSSIBILITY OF SUCH DAMAGES. EXCLUDED DAMAGES INCLUDE, BUT ARE NOT LIMITED TO, COST OF REMOVAL OR REINSTALLATION, ANCILLARY COSTS TO THE PROCUREMENT OF SUBSTITUTE GOODS OR SERVICES, RETESTING, OUTSIDE COMPUTER TIME, LABOR COSTS, LOSS OF GOODWILL, LOSS OF PROFITS, LOSS OF SAVINGS, LOSS OF USE, LOSS OF DATA, OR BUSINESS INTERRUPTION. NO CLAIM, SUIT OR ACTION SHALL BE BROUGHT AGAINST TI MORE THAN TWELVE (12) MONTHS AFTER THE EVENT THAT GAVE RISE TO THE CAUSE OF ACTION HAS OCCURRED.

8.2 *Specific Limitations.* IN NO EVENT SHALL TI'S AGGREGATE LIABILITY FROM ANY USE OF AN EVM PROVIDED HEREUNDER, INCLUDING FROM ANY WARRANTY, INDEMNITY OR OTHER OBLIGATION ARISING OUT OF OR IN CONNECTION WITH THESE TERMS, , EXCEED THE TOTAL AMOUNT PAID TO TI BY USER FOR THE PARTICULAR EVM(S) AT ISSUE DURING THE PRIOR TWELVE (12) MONTHS WITH RESPECT TO WHICH LOSSES OR DAMAGES ARE CLAIMED. THE EXISTENCE OF MORE THAN ONE CLAIM SHALL NOT ENLARGE OR EXTEND THIS LIMIT.

9. *Return Policy.* Except as otherwise provided, TI does not offer any refunds, returns, or exchanges. Furthermore, no return of EVM(s) will be accepted if the package has been opened and no return of the EVM(s) will be accepted if they are damaged or otherwise not in a resalable condition. If User feels it has been incorrectly charged for the EVM(s) it ordered or that delivery violates the applicable order, User should contact TI. All refunds will be made in full within thirty (30) working days from the return of the components(s), excluding any postage or packaging costs.

10. *Governing Law:* These terms and conditions shall be governed by and interpreted in accordance with the laws of the State of Texas, without reference to conflict-of-laws principles. User agrees that non-exclusive jurisdiction for any dispute arising out of or relating to these terms and conditions lies within courts located in the State of Texas and consents to venue in Dallas County, Texas. Notwithstanding the foregoing, any judgment may be enforced in any United States or foreign court, and TI may seek injunctive relief in any United States or foreign court.

IMPORTANT NOTICE AND DISCLAIMER

TI PROVIDES TECHNICAL AND RELIABILITY DATA (INCLUDING DATASHEETS), DESIGN RESOURCES (INCLUDING REFERENCE DESIGNS), APPLICATION OR OTHER DESIGN ADVICE, WEB TOOLS, SAFETY INFORMATION, AND OTHER RESOURCES "AS IS" AND WITH ALL FAULTS, AND DISCLAIMS ALL WARRANTIES, EXPRESS AND IMPLIED, INCLUDING WITHOUT LIMITATION ANY IMPLIED WARRANTIES OF MERCHANTABILITY, FITNESS FOR A PARTICULAR PURPOSE OR NON-INFRINGEMENT OF THIRD PARTY INTELLECTUAL PROPERTY RIGHTS.

These resources are intended for skilled developers designing with TI products. You are solely responsible for (1) selecting the appropriate TI products for your application, (2) designing, validating and testing your application, and (3) ensuring your application meets applicable standards, and any other safety, security, or other requirements. These resources are subject to change without notice. TI grants you permission to use these resources only for development of an application that uses the TI products described in the resource. Other reproduction and display of these resources is prohibited. No license is granted to any other TI intellectual property right or to any third party intellectual property right. TI disclaims responsibility for, and you will fully indemnify TI and its representatives against, any claims, damages, costs, losses, and liabilities arising out of your use of these resources.

TI's products are provided subject to TI's Terms of Sale (www.ti.com/legal/termsofsale.html) or other applicable terms available either on ti.com or provided in conjunction with such TI products. TI's provision of these resources does not expand or otherwise alter TI's applicable warranties or warranty disclaimers for TI products.

Mailing Address: Texas Instruments, Post Office Box 655303, Dallas, Texas 75265
Copyright © 2018, Texas Instruments Incorporated