

TMP104EVM Evaluation Board and Software Tutorial

This user's guide describes the characteristics, operation, and use of the TMP104EVM evaluation board. It discusses how to set up and configure the software and hardware and reviews various aspects of the program operation. Throughout this document, the terms *evaluation board*, *evaluation module*, and *EVM* are synonymous with the TMP104EVM. This user's guide also includes information regarding operating procedures and input/output connections, an electrical schematic, printed circuit board (PCB) layout drawings, and a parts list for the EVM.

Contents

1	Overview	2
2	TMP104EVM Hardware Setup	3
3	TMP104EVM Hardware	6
4	TMP104EVM Software	8
5	TMP104EVM Software Overview	10
6	TMP104EVM Documentation	17

List of Figures

1	Hardware Included with TMP104EVM Kit	2
2	TMP104EVM Hardware Setup	3
3	TMP104EVM Board Block Diagram	4
4	SM-USB-DIG Platform Block Diagram	5
5	Connecting SM-USB-DIG Platform	6
6	Confirmation of SM-USB-DIG Platform Driver Installation.....	6
7	10-Pin Ribbon Cable Extender	7
8	TMP104EVM Software Installation	8
9	TMP104EVM License Agreements	9
10	TMP104EVM Software Interface	10
11	Communication Error with the TMP104EVM	10
12	TMP104 Initialization.....	11
13	TMP104 Writing to Registers	12
14	Registers Tab	13
15	Interrupts.....	14
16	Changing Conversion Rates	15
17	Changing Operational Modes.....	15
18	Temperature Graphs Tab	16
19	TMP104EVM Board Schematic.....	17
20	TMP104EVM PCB Top Layer (Component Layout)	18

Microsoft, Windows are registered trademarks of Microsoft Corporation.
 I²C is a trademark of NXP Semiconductors.
 WinZIP is a registered trademark of WinZip International LLC.
 All other trademarks are the property of their respective owners.

1 Overview

The [TMP104](#) is a digital output temperature sensor in a four-ball, wafer chip-scale package (WCSP). The TMP104 is capable of reading temperatures to a resolution of 1°C, and is specified for operation over a temperature range of -40°C to +125°C.

The TMP104 features a one-wire UART-style interface that supports daisy-chain configurations. In addition, the interface supports multiple device access (MDA) commands that allow the master to communicate with multiple devices on the bus simultaneously, eliminating the need to send individual commands to each TMP104 on the bus. Up to 16 TMP104s can be tied together in parallel and easily read by the host. This device is especially ideal for space-constrained, power-sensitive applications with multiple temperature measurement zones that must be monitored.

The TMP104EVM is a platform for evaluating the performance of the TMP104 under various signal, reference, and supply conditions. This document gives a general overview of the TMP104EVM and provides a general description of the features and functions to be considered while using this evaluation module.

1.1 TMP104EVM Kit Contents

[Table 1](#) summarizes the contents of the TMP104EVM kit. [Figure 1](#) shows all of the included hardware. Contact the [Texas Instruments Product Information Center](#) nearest you if any component is missing. It is highly recommended that you also check the [TMP104 product folder](#) on the TI web site at www.ti.com to verify that you have the latest versions of the related software.

Table 1. TMP104EVM Kit Contents

Item	Quantity
TMP104EVM PCB test board	1
SM-USB-DIG platform PCB	1
USB extender cable	1
10-pin connector ribbon cable	1
User's guide CD-ROM	1



Figure 1. Hardware Included with TMP104EVM Kit

1.2 Related Documentation from Texas Instruments

The following documents provide information regarding Texas Instruments' integrated circuits used in the assembly of the TMP104EVM. This user's guide is available from the TI web site under literature number **SBOU118**. Any letter appended to the literature number corresponds to the document revision that is current at the time of the writing of this document. Newer revisions may be available from the [TI web site](#), or call the Texas Instruments' Literature Response Center at (800) 477-8924 or the Product Information Center at (972) 644-5580. When ordering, identify the document by both title and literature number.

Table 2. Related Documentation

Document	Literature Number
TMP104 product data sheet	SBOS564
SM-USB-DIG platform user guide	SBOU098

2 TMP104EVM Hardware Setup

The TMP104EVM hardware consists of the SM-USB-DIG and TMP104 Test Board; these components are easily connected through a 10-pin, board-to-board connector that should be attached to the SM-USB-DIG platform and the TMP104 Test Board. Once these two boards are connected, simply plug the USB device from the SM-USB-DIG into the computer, as shown in [Figure 2](#).



Figure 2. TMP104EVM Hardware Setup

2.1 Theory of Operation for the TMP104 Hardware

Figure 3 shows the basic interactions that occur on the TMP104 Test Board. The board requires power and I²C™ communication with the SM-USB-DIG. This configuration allows the TMP104EVM software to communicate with the SM-USB-DIG and the TMP104 Test Board. In addition, test points allow for application-specific connections to be used on the TMP104 Test Board.

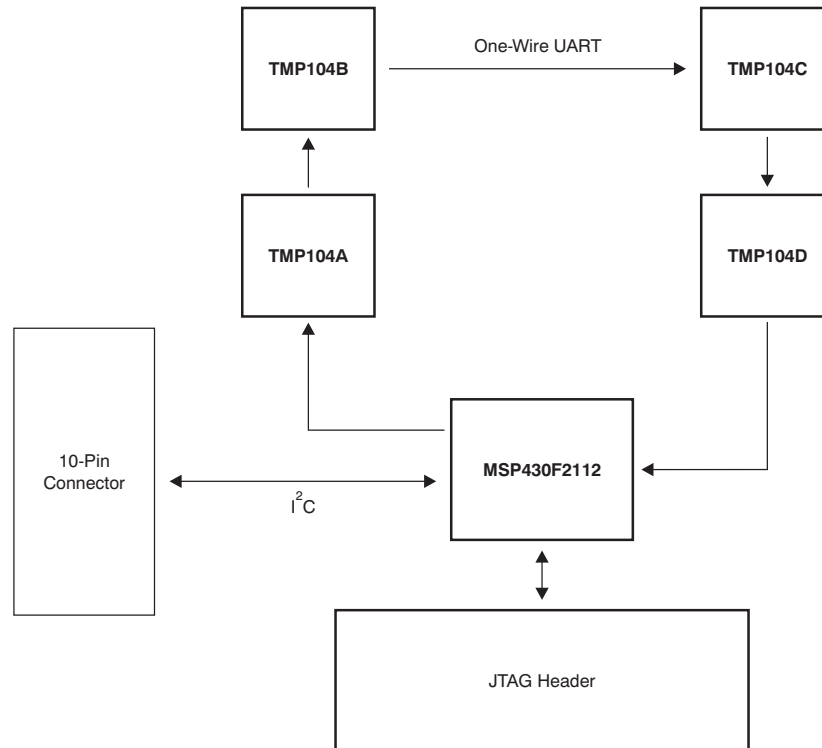

Figure 3. TMP104EVM Board Block Diagram

2.2 Signal Definitions of H1 (10-Pin Male Connector Socket)

Table 3 shows the pinout for the 10-pin connector socket used to communicate between the TMP104EVM and the SM-USB-DIG. It should be noted that the TMP104EVM uses only the necessary I²C communication lines (pins 1 and 3) and the V_{DUT} and GND (pins 6 and 8, respectively) to issue commands to the TMP104.

Table 3. H1 Signal Definition for TMP104EVM

Pin on U1	Signal	Description
1	I2C_SCL	I ² C clock signal (SCL)
2	CTRL/MEAS4	GPIO: control output or measure input
3	I2C_SDA1	I ² C data signal (SDA)
4	CTRL/MEAS5	GPIO: control output or measure input
5	SPI_DOUT1	SPI data output (MOSI)
6	V _{DUT}	Switchable DUT power supply: +3.3 V, +5 V, Hi-Z (disconnected) ⁽¹⁾
7	SPI_CLK	SPI clock signal (SCLK)
8	GND	Power return (GND)
9	SPI_CS1	SPI chip-select signal (\overline{CS})
10	SPI_DIN1	SPI data input (MISO)

⁽¹⁾ When V_{DUT} is Hi-Z, all digital I/O are Hi-Z as well.

2.2.1 Theory of Operation for the SM-USB-DIG Platform

Figure 4 shows the block diagram for the SM-USB-DIG platform. This platform is a general-purpose data acquisition system that is used on several different Texas Instruments evaluation modules. The details of its operation are included in a separate document, [SBOU098](#) (available for download at [www.ti.com](#)). The block diagram shown in Figure 4 gives a brief overview of the platform. The primary control device on the SM-USB-DIG platform is the [TUSB3210](#).

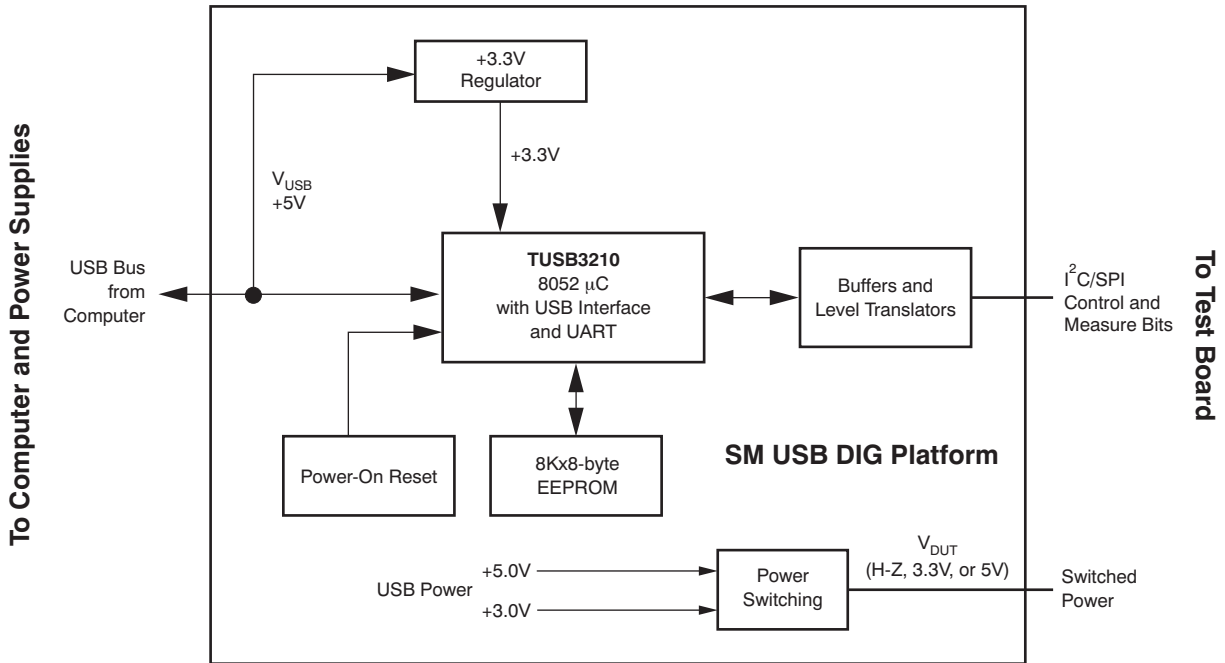

Figure 4. SM-USB-DIG Platform Block Diagram

3 TMP104EVM Hardware

3.1 Electrostatic Discharge Warning

CAUTION

Many of the components on the TMP104EVM are susceptible to damage by electrostatic discharge (ESD). Customers are advised to observe proper ESD handling precautions when unpacking and handling the EVM, including the use of a grounded wrist strap at an approved ESD workstation.

3.2 Typical Hardware Connections

First, connect the TMP104EVM test board to the SM-USB-DIG and then connect the USB cable, as shown in [Figure 5](#). Make sure that all connectors are properly aligned and pushed together firmly. Loose connections may cause intermittent operation.

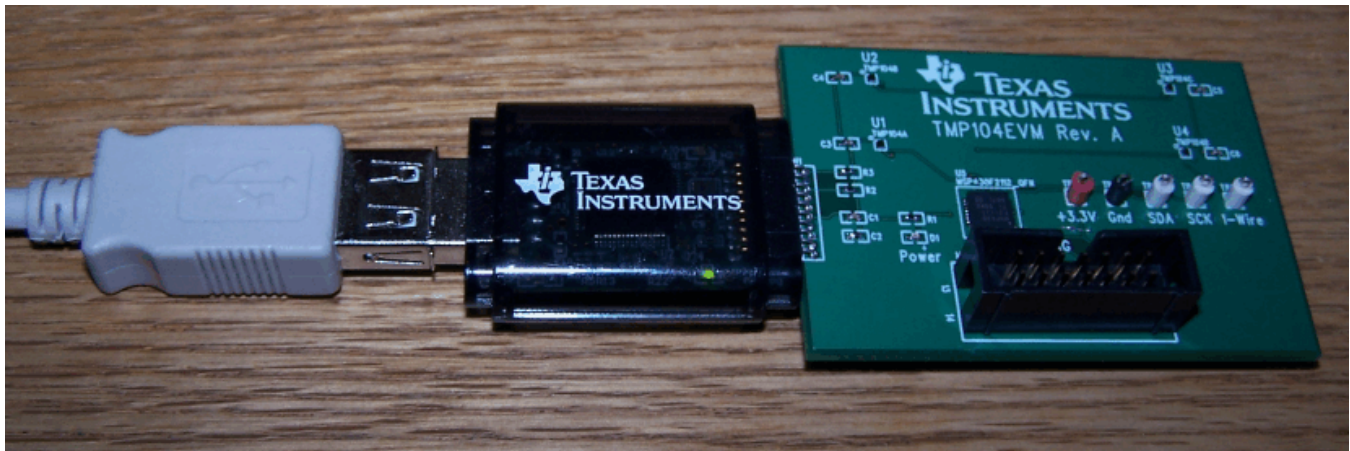

Figure 5. Connecting SM-USB-DIG Platform

3.3 Connecting the USB Cable to the DIG

[Figure 6](#) shows the typical response to connecting the SM-USB-DIG Platform board to a PC USB port for the first time. Typically, the computer responds with a *Found New Hardware, USB Device* pop-up dialog. The pop-up window then changes to *Found New Hardware, USB Human Interface Device*. This pop-up indicates that the device is ready to be used. The SM-USB-DIG Platform uses the human interface device drivers that are part of the Microsoft® Windows® operating system.

In some cases, the Windows *Add Hardware Wizard* appears. If this prompt pops up, allow the system device manager to install the human interface drivers by clicking **Yes** when requested to install drivers. Windows confirms installation of the drivers with the message shown in [Figure 6](#).

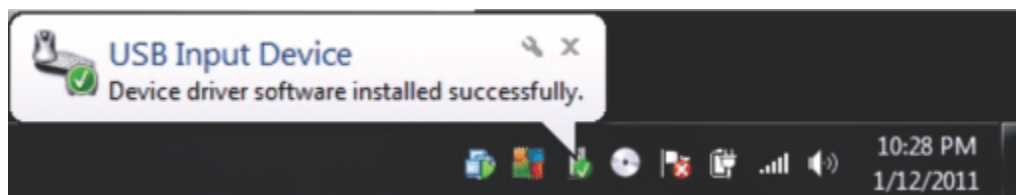

Figure 6. Confirmation of SM-USB-DIG Platform Driver Installation

3.4 TMP104EVM Features

This section describes some of the hardware features present on the TMP104EVM test board.

3.4.1 External Power and Communication Headers

The TMP104 Test Board features test points to provide external power and monitor the one-wire UART protocol. It is recommended that the SM-USB-DIG should not be attached when external power and communication are used.

The TMP104EVM also has SDA and SCL test points to monitor the I²C bus between the SM-USB-DIG and the TMP104 Test Board.

3.4.2 MSP430F2112

The TMP104 Test Board has an [MSP430F2112](#) microcontroller that converts I²C commands from the SM-USB-DIG into UART commands to read from and write to the TMP104s.

3.4.3 10-Pin Connector Ribbon Extender (Optional)

The TMP104EVM kit ships with an optional ribbon cable for extending the connection between the SM-USB-DIG and the PCB. This extension cable can be useful if high temperature tests must be run on the test board, because the SM-USB-DIG is not rated for high temperatures. To connect the ribbon cable, attach the cable to the EVM and SM-USB-DIG, as shown in [Figure 7](#).

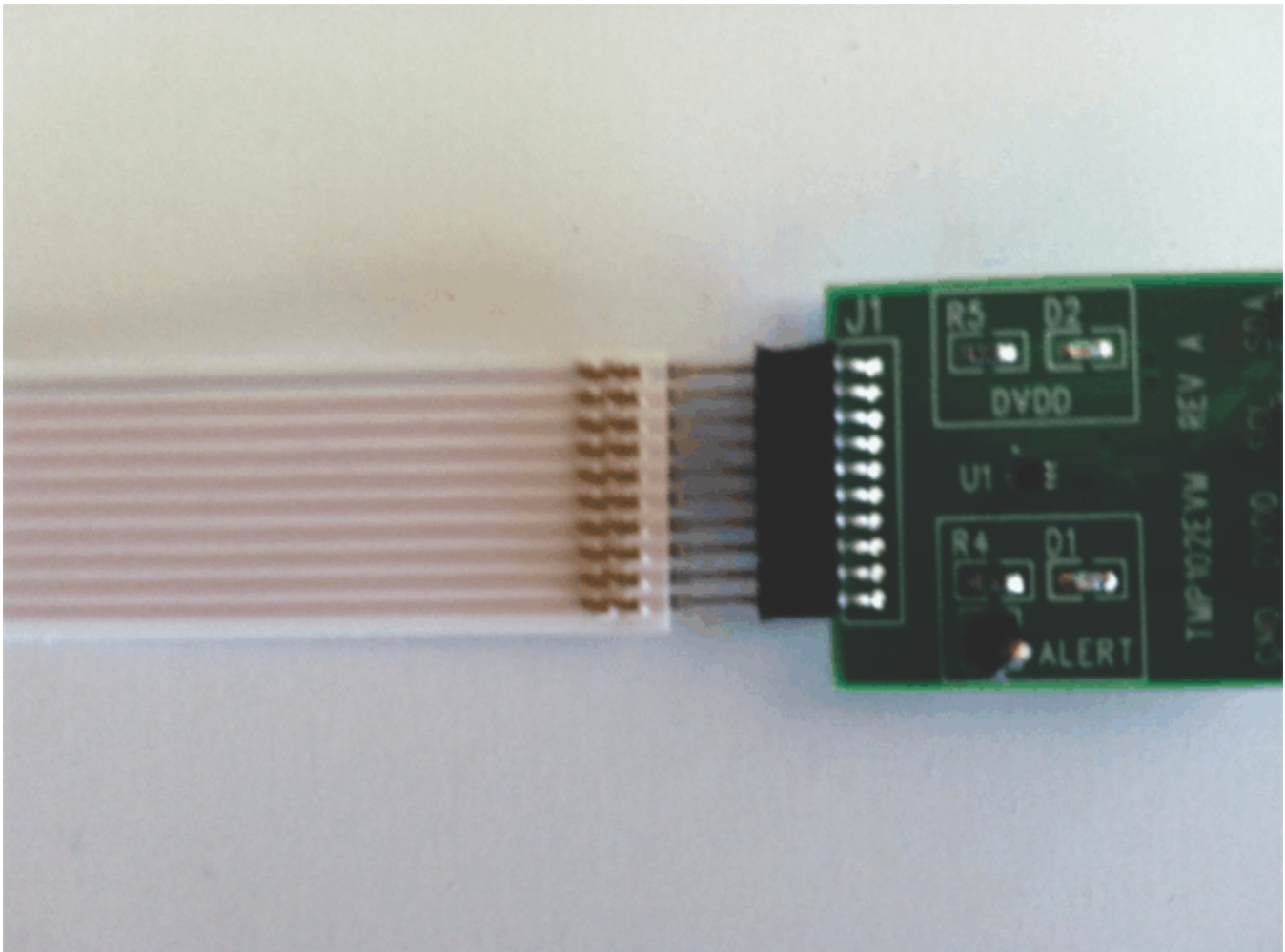

Figure 7. 10-Pin Ribbon Cable Extender

4 TMP104EVM Software

This section discusses how to install the TMP104EVM software.

4.1 Hardware Requirements

The TMP104EVM software has been tested on Microsoft Windows XP operating systems (OS) with United States and European regional settings. The software should also function on other Windows OS platforms.

4.2 Software Installation

The TMP104EVM software is included on the CD that is shipped with the EVM kit. It is also available through the [TMP104EVM product folder](#) on the TI website. To install the software to a computer, insert the disc into an available CD-ROM drive. Navigate to the drive contents and open the TMP104EVM software folder. Locate the compressed file (*TMP104EVM.zip*) and open it using WinZIP® or a similar file compression program; extract the TMP104EVM files into a specific TMP104EVM folder (for example, *C:\TMP104EVM*) on your hard drive.

Once the files are extracted, navigate to the TMP104EVM folder you created on the hard drive. Locate the *setup.exe* file and execute it to start the installation. The TMP104 software installer file then begins the installation process, as shown in [Figure 8](#).

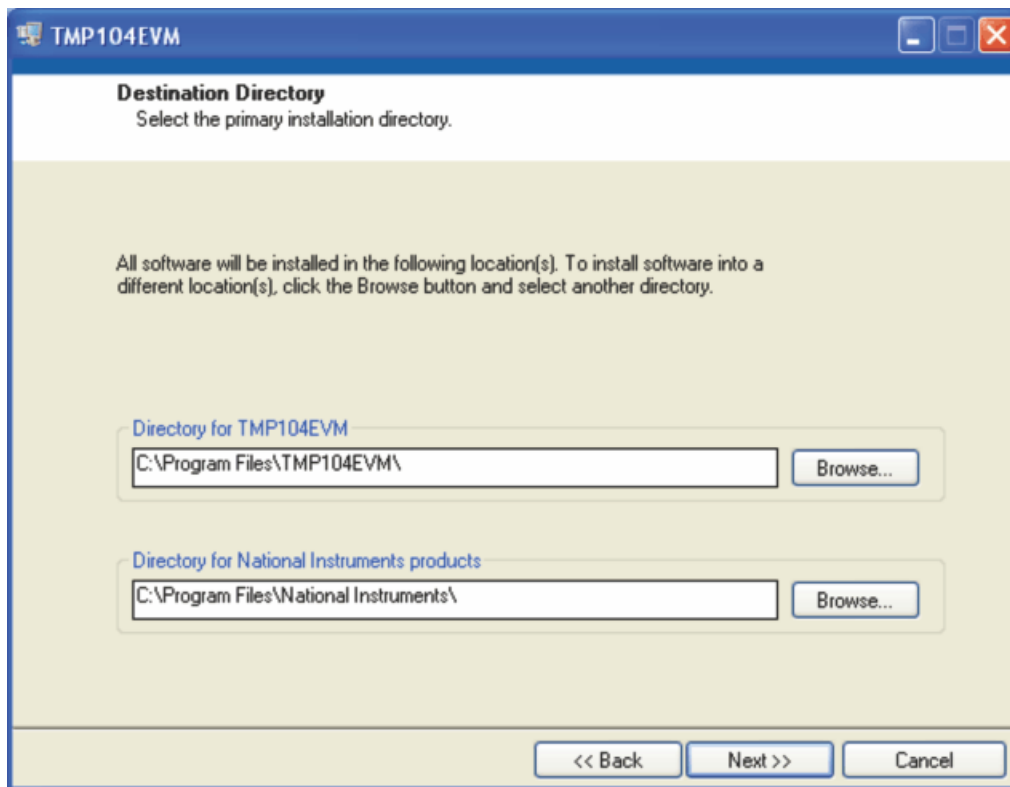

Figure 8. TMP104EVM Software Installation

After the installation process initializes, the user is given the choice of selecting the directory in which to install the program; the default location is *C:\Program Files\TMP104* and *C:\Program Files\National Instruments*. Following this option, two license agreements are presented that must be accepted, as shown in [Figure 9](#). After accepting the Texas Instruments and National Instruments license agreements, the progress bar opens and shows the installation of the software. Once the installation process is completed, click **Finish**.

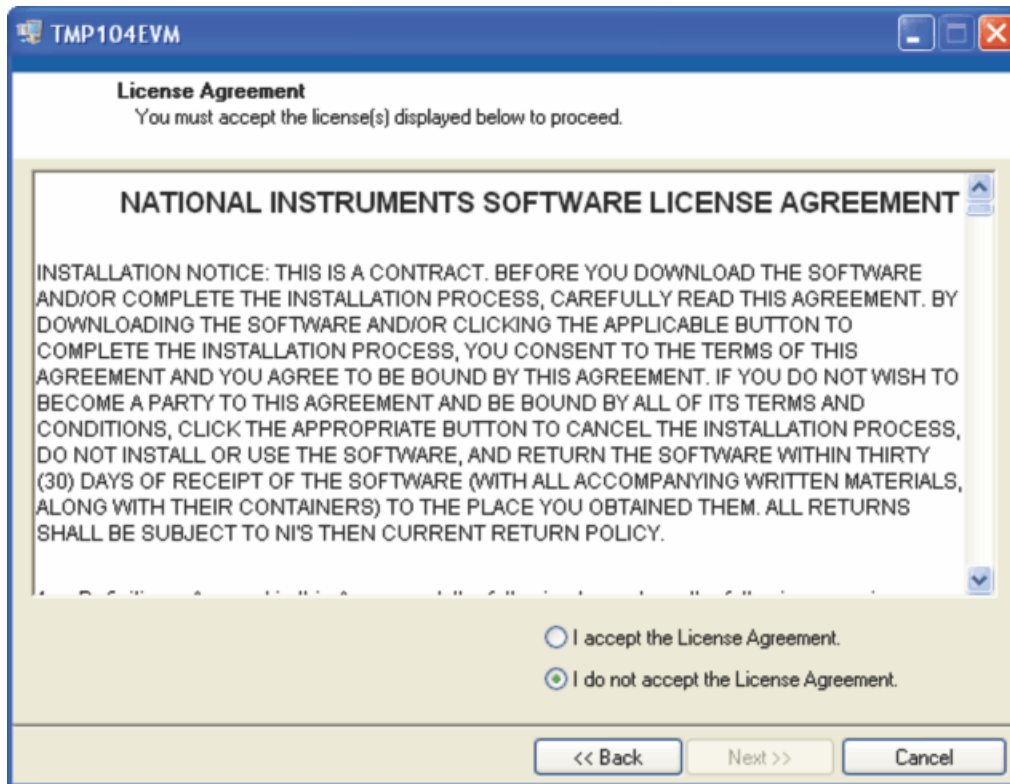

Figure 9. TMP104EVM License Agreements

5 TMP104EVM Software Overview

This section discusses how to use the TMP104EVM software.

5.1 Starting the TMP104EVM Software

The TMP104 software can be operated through the Windows *Start* menu. From *Start*, select *All Programs*; then select the *TMP104EVM* program.

Figure 10 illustrates how the software should appear if the TMP104EVM is functioning properly.

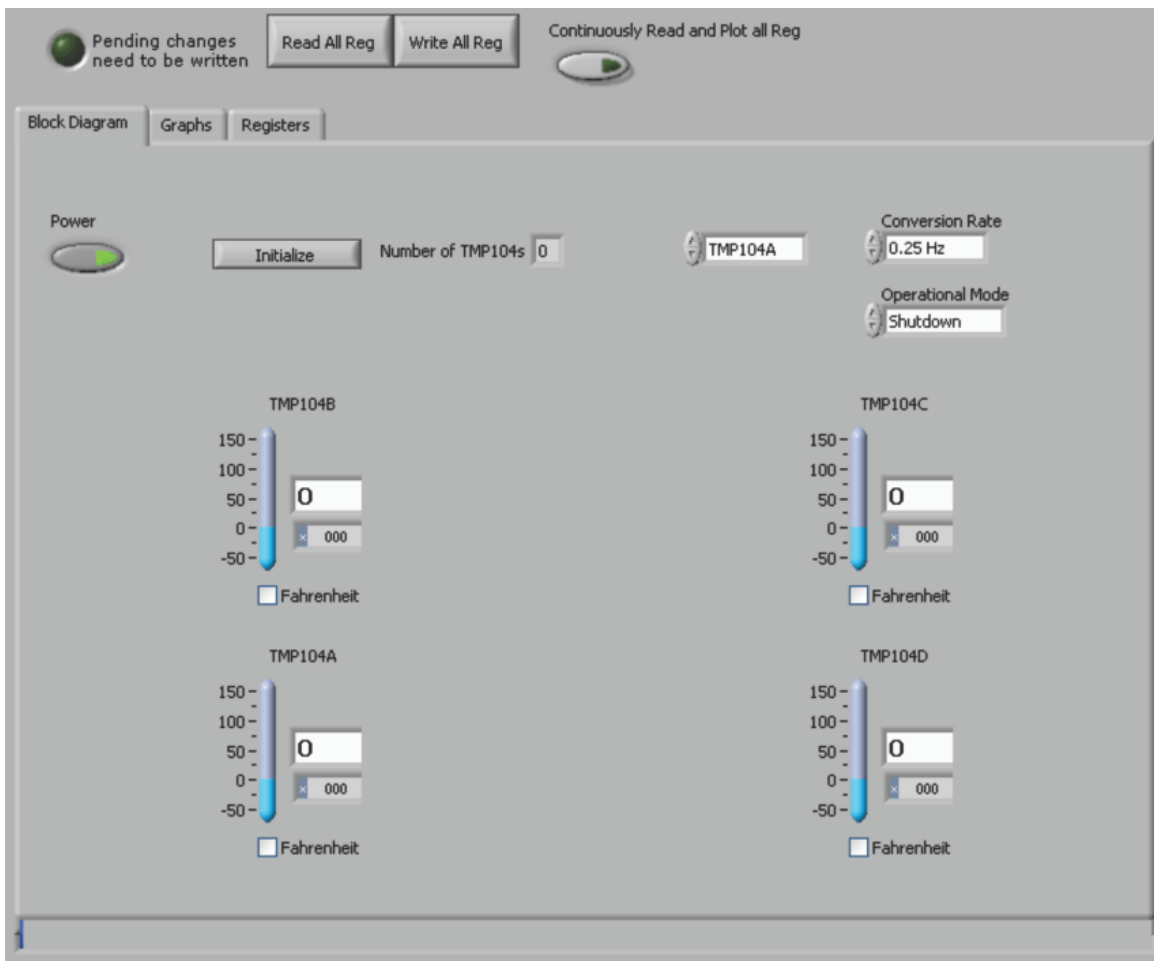

Figure 10. TMP104EVM Software Interface

Figure 11 shows an error message that is displayed if the PC cannot communicate with the EVM. If you receive this error message, first check to see that the USB extension cable is properly connected to both the PC USB port and to the SM-USB-DIG platform. Another possible source for this error is a problem with the PC USB Human Interface Device driver. Make sure that the device is recognized when the USB cable is plugged in; recognition is indicated by a Windows-generated confirmation sound.

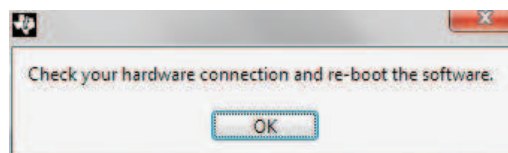

Figure 11. Communication Error with the TMP104EVM

5.2 Using the TMP104 Software

5.2.1 Reading from Registers

When first starting the TMP104EVM software, the user should confirm stable connections to the test board by toggling the **Power** button to provide power to the TMP104. Then, the user should press the **Initialize** button, as shown in [Figure 12](#). The *Number of TMP104s* box should change from a 0 to a 4 to indicate that all connected TMP104s have assigned themselves an address on the UART daisy-chain.

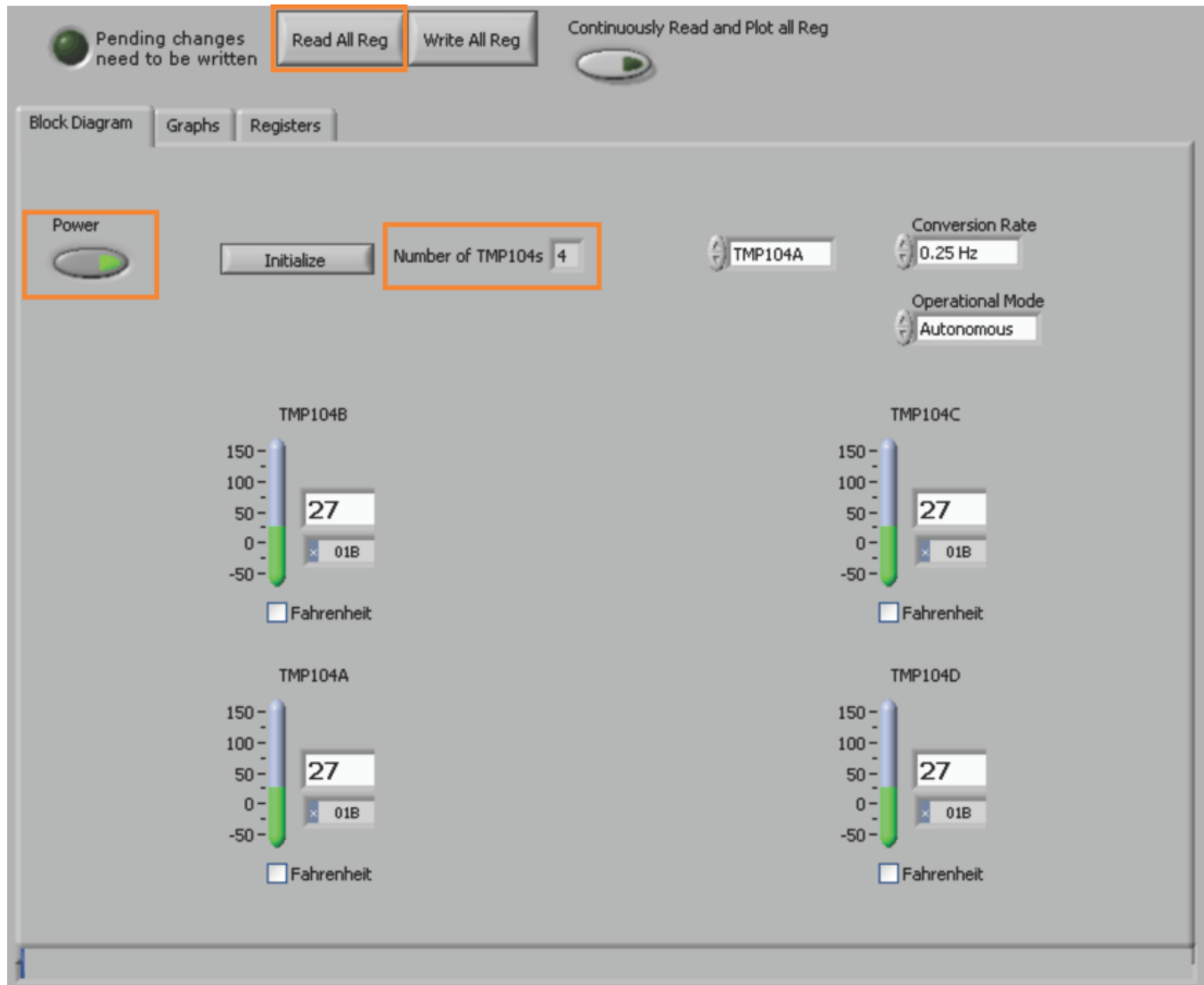

Figure 12. TMP104 Initialization

To check the status of all registers, press the **Read All Reg** button; see [Figure 13](#). If the device is functioning correctly, no error messages are displayed.

5.2.2 Writing to Registers

The TMP104EVM software contains two different methods for writing data: *Write All Reg* and *Auto-Write Reg*, as Figure 13 shows.

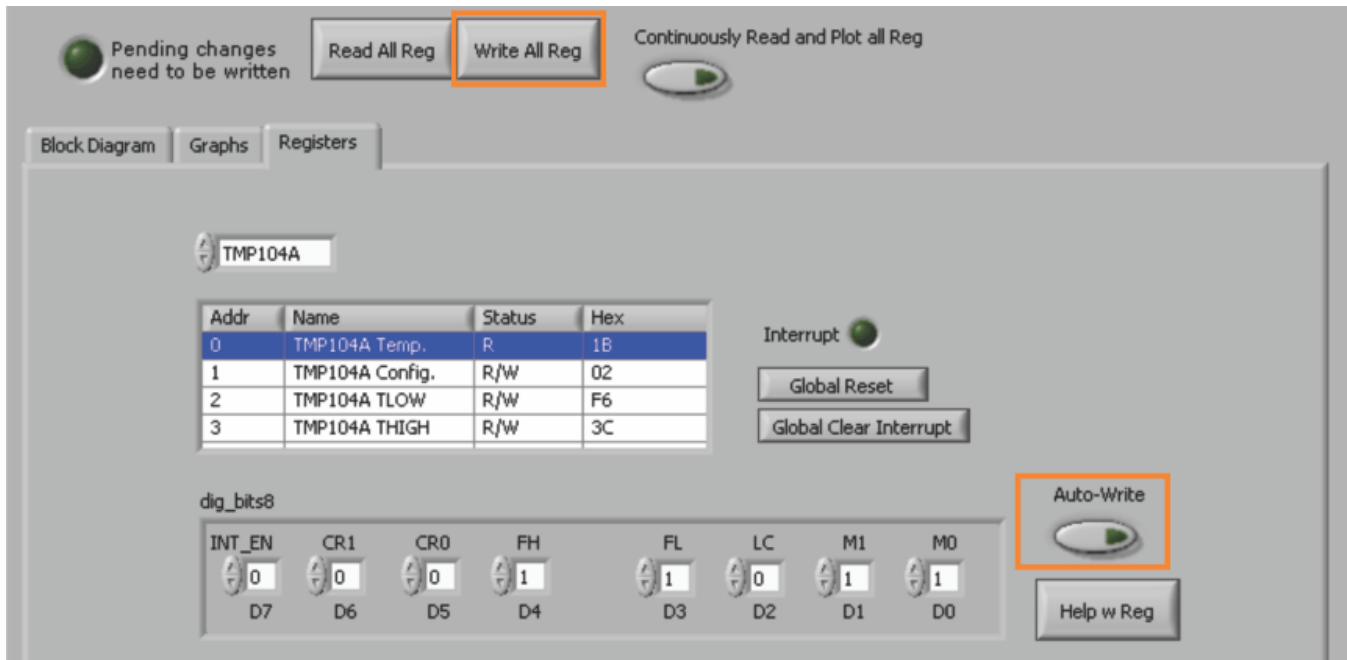

Figure 13. TMP104 Writing to Registers

NOTE: The user cannot simultaneously perform the *Read All Registers* and *Auto-Write Registers* functions.

5.2.3 Registers Tab

The Registers tab displays the individual register setting for the TMP104 sensors. To change which TMP104 registers are displayed, use the drop-down box shown in [Figure 14](#). For more information on the individual registers and the respective bit meanings, simply highlight the desired register and press the **Help with Reg** button, as indicated in [Figure 14](#).

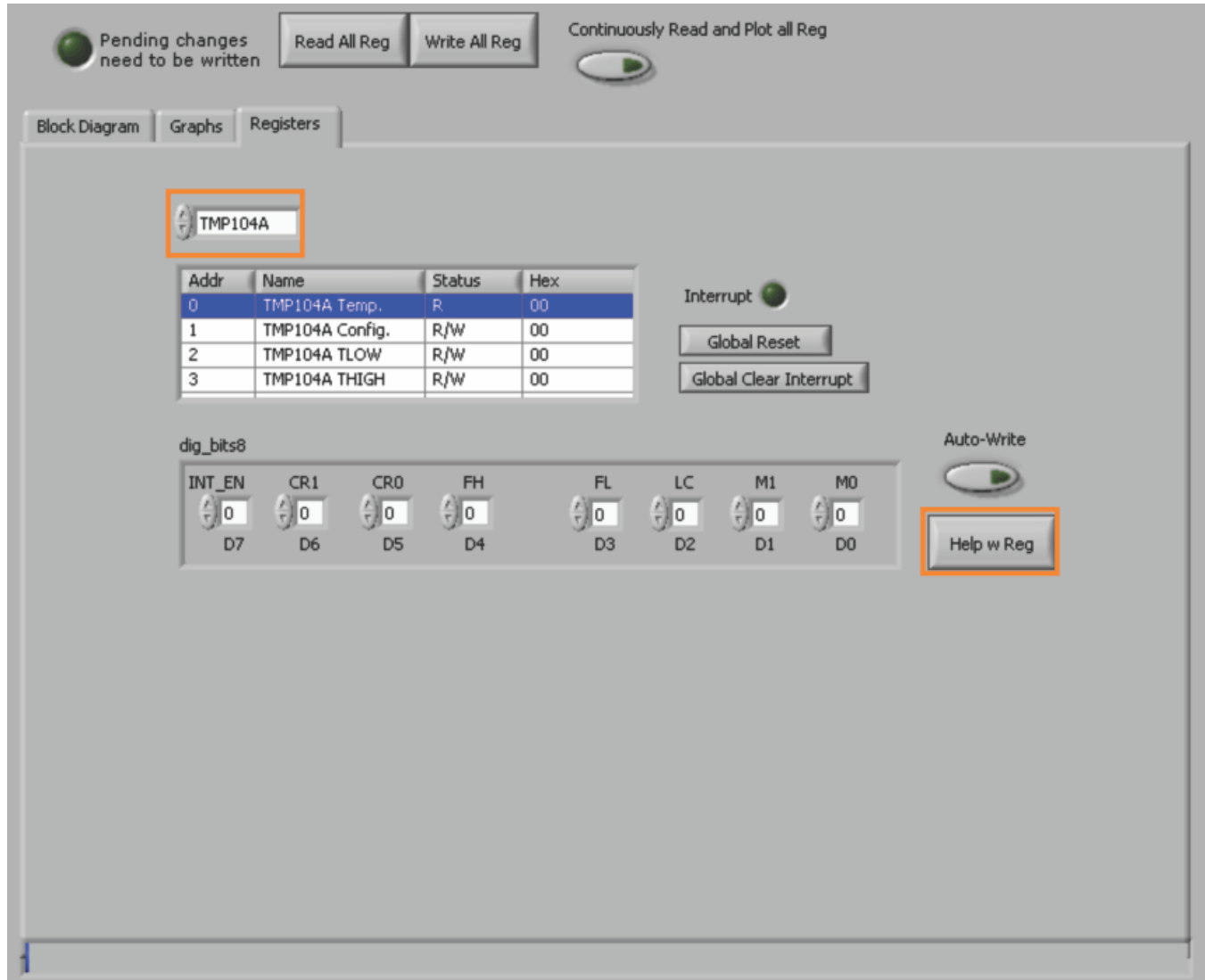
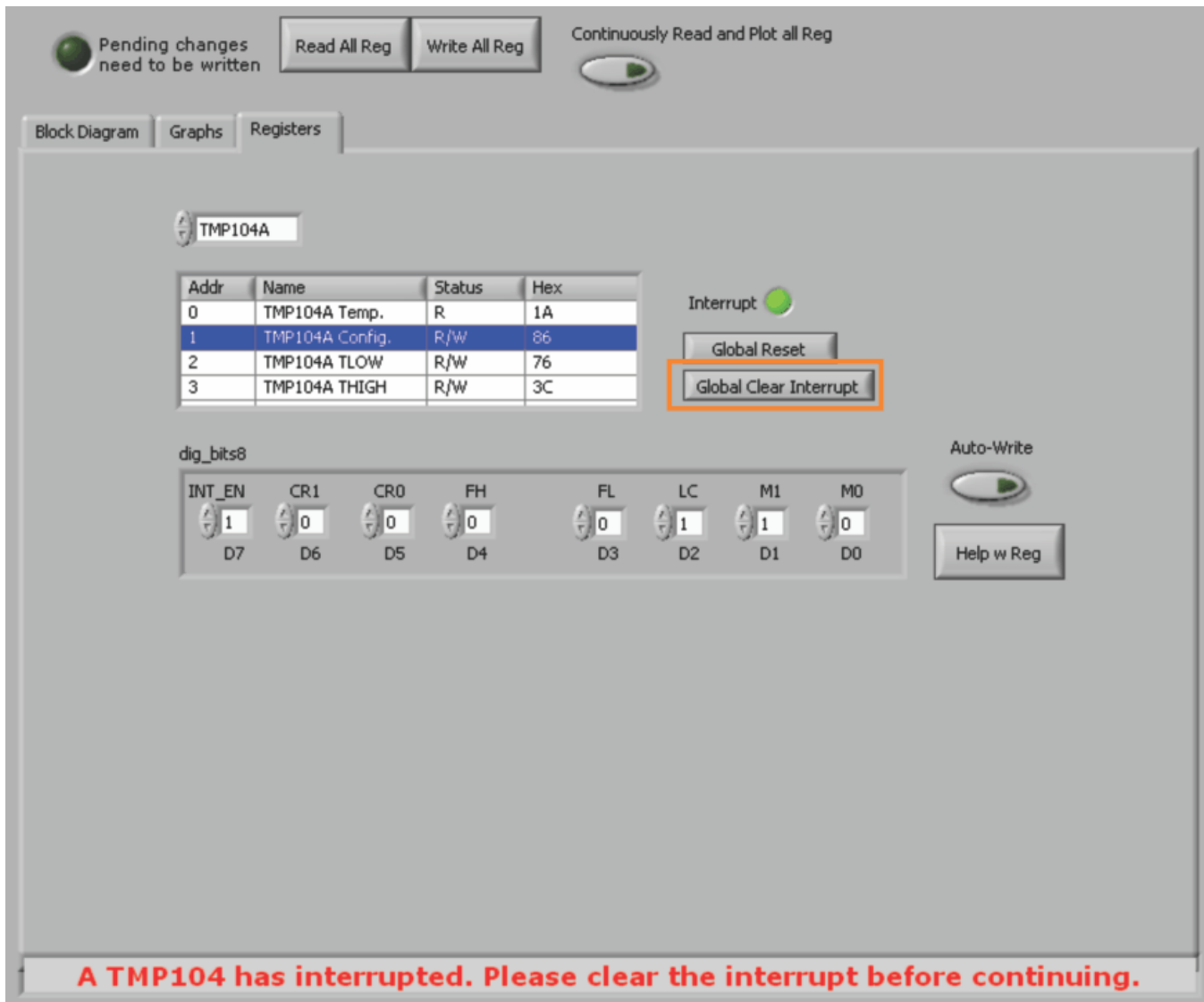

Figure 14. Registers Tab

Note that when interrupts are enabled, communication with the TMP104s cannot continue until the interrupt is cleared (as explained in the [TMP104 data sheet](#)). If a temperature interrupt occurs, the screen appears similar that shown in [Figure 15](#). Communication with the TMP104s cannot continue until a *Global Clear Interrupt* command has been issued by clicking the appropriate button, as indicated in [Figure 15](#).



Pending changes need to be written

Read All Reg Write All Reg Continuously Read and Plot all Reg

Block Diagram Graphs Registers

TMP104A

Addr	Name	Status	Hex
0	TMP104A Temp.	R	1A
1	TMP104A Config.	R/W	86
2	TMP104A TLOW	R/W	76
3	TMP104A THIGH	R/W	3C

Interrupt

Global Reset

Global Clear Interrupt

dig_bits8

INT_EN	CR1	CR0	FH	FL	LC	M1	M0
<input checked="" type="checkbox"/>	<input type="checkbox"/>	<input type="checkbox"/>	<input type="checkbox"/>	<input type="checkbox"/>	<input checked="" type="checkbox"/>	<input checked="" type="checkbox"/>	<input type="checkbox"/>
D7	D6	D5	D4	D3	D2	D1	D0

Auto-Write

Help w Reg

A TMP104 has interrupted. Please clear the interrupt before continuing.

Figure 15. Interrupts

5.2.4 Changing Conversion Rates

The conversion rate for each TMP104 may be changed either on the Registers tab or by selecting a specific TMP104 device, cycling through conversion rates, and clicking the **Write All Reg** button, as indicated in Figure 16.

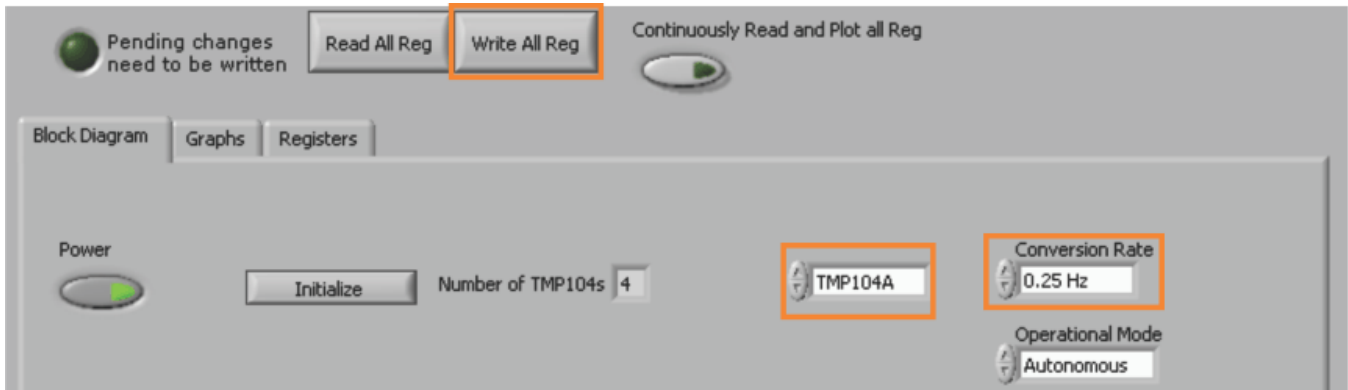

Figure 16. Changing Conversion Rates

5.2.5 Changing Operational Modes

The operational mode for each connected TMP104 device may be changed either on the Registers tab or by selecting a TMP104, cycling through operational modes, and clicking the **Write All Reg** button, as indicated in Figure 17.

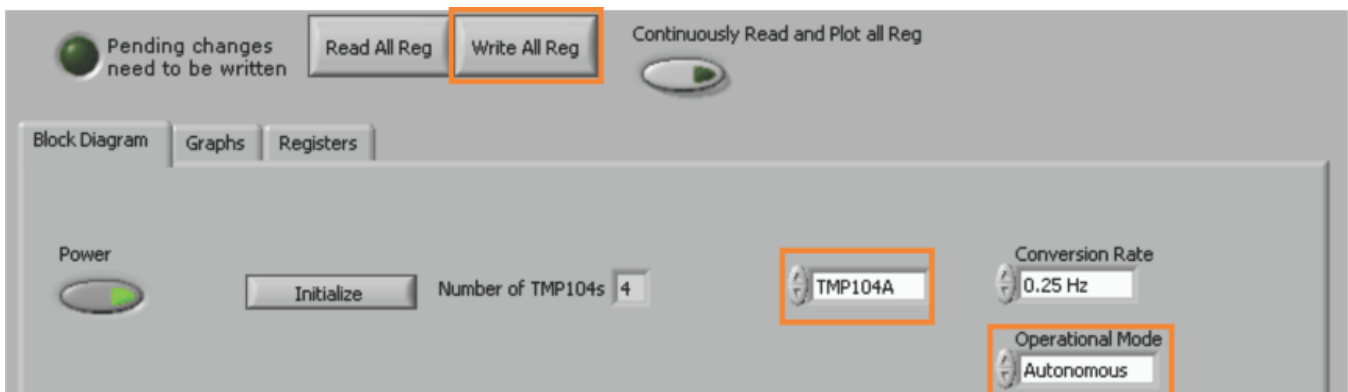

Figure 17. Changing Operational Modes

5.2.6 Temperature Graphs Tab

In *Continuously Read and Plot All Reg* mode, the respective value for each of the local temperature sensors on the TMP104EVM is plotted in degrees Celsius (°C). [Figure 18](#) shows the Temperature Graphs tab.

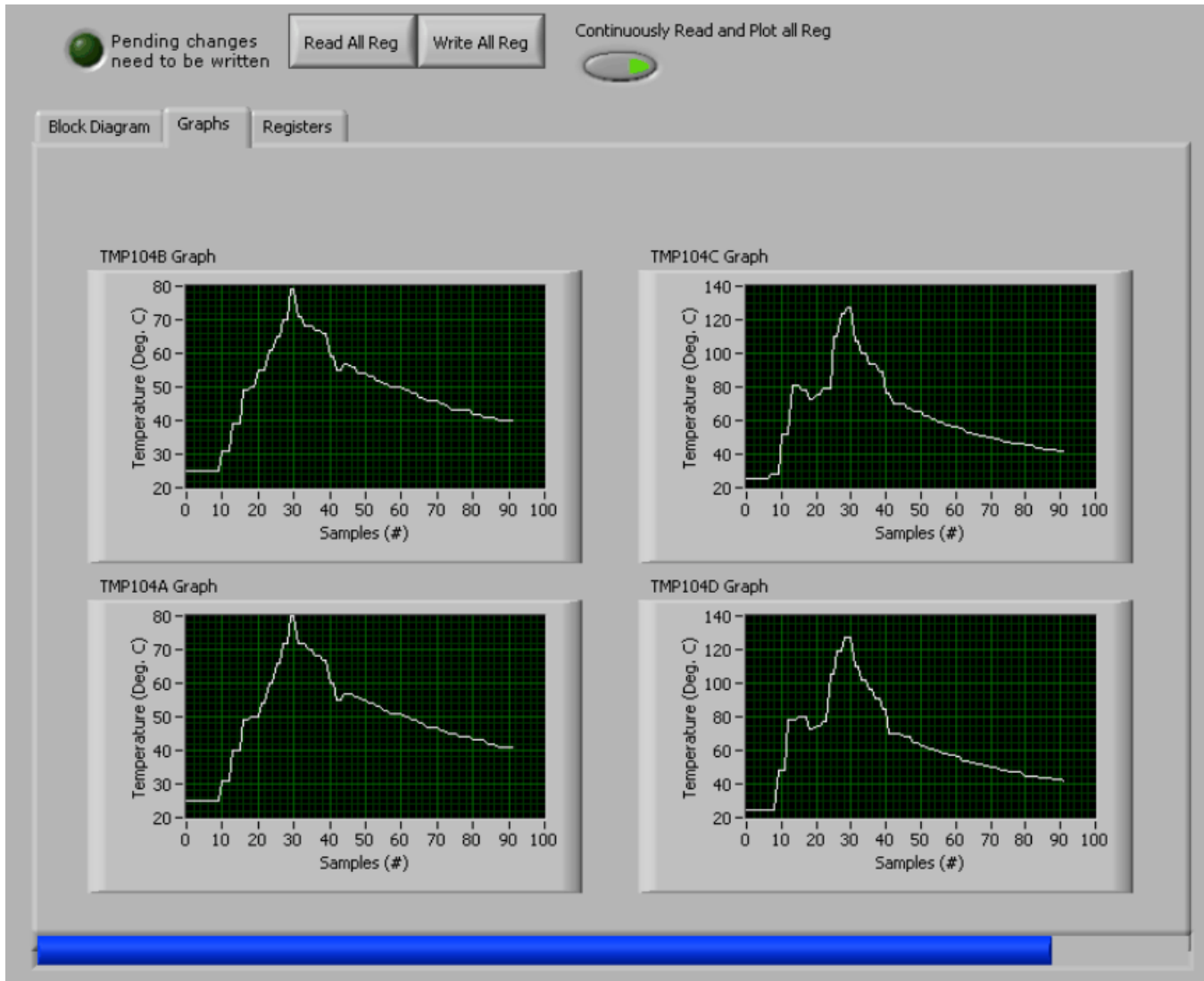

Figure 18. Temperature Graphs Tab

6 TMP104EVM Documentation

This section contains the complete bill of materials and PCB layout for the TMP104EVM.

NOTE: These board layouts are not to scale. These image are intended to show how the board is laid out; they are not intended to be used for manufacturing TMP104EVM PCBs.

6.1 TMP104EVM Board Schematic

Figure 19 shows the schematic for the TMP104EVM board.

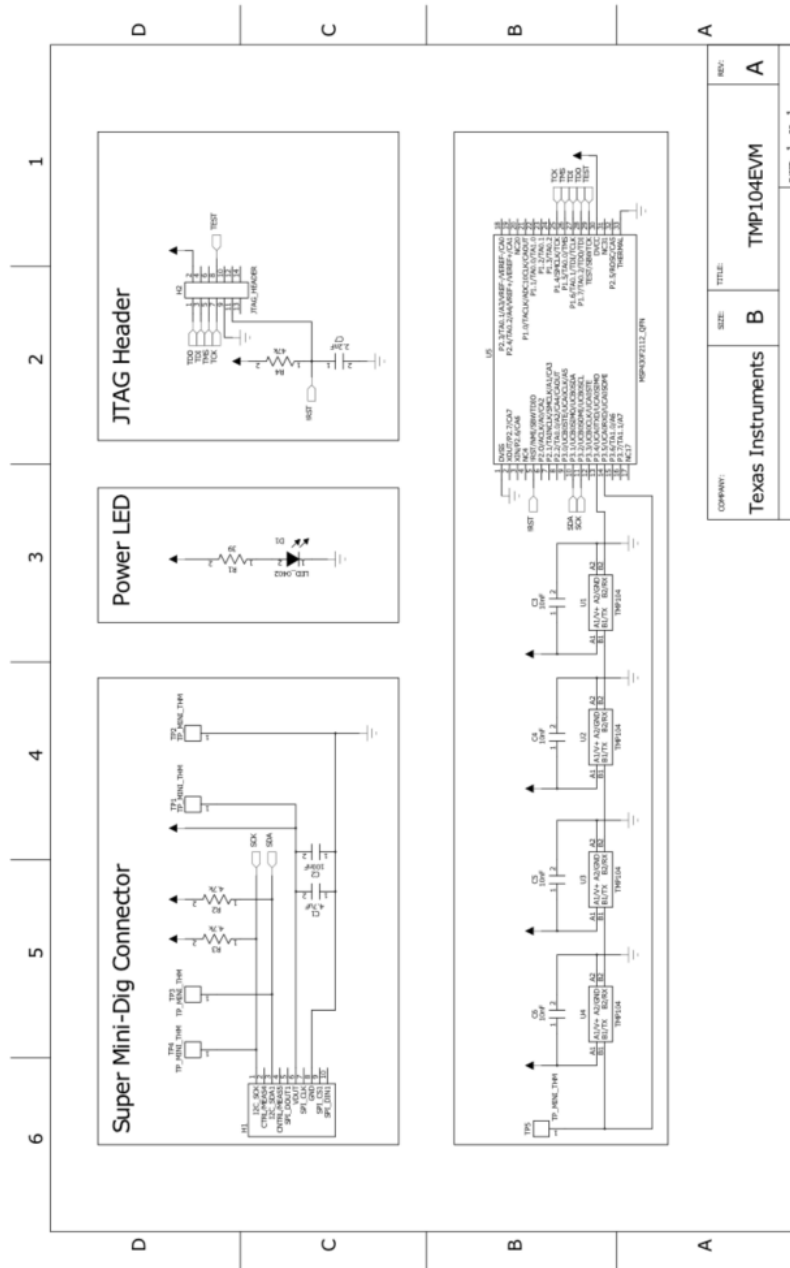

Figure 19. TMP104EVM Board Schematic

6.2 PCB Layout

Figure 20 shows the PCB layout of the TMP104EVM.

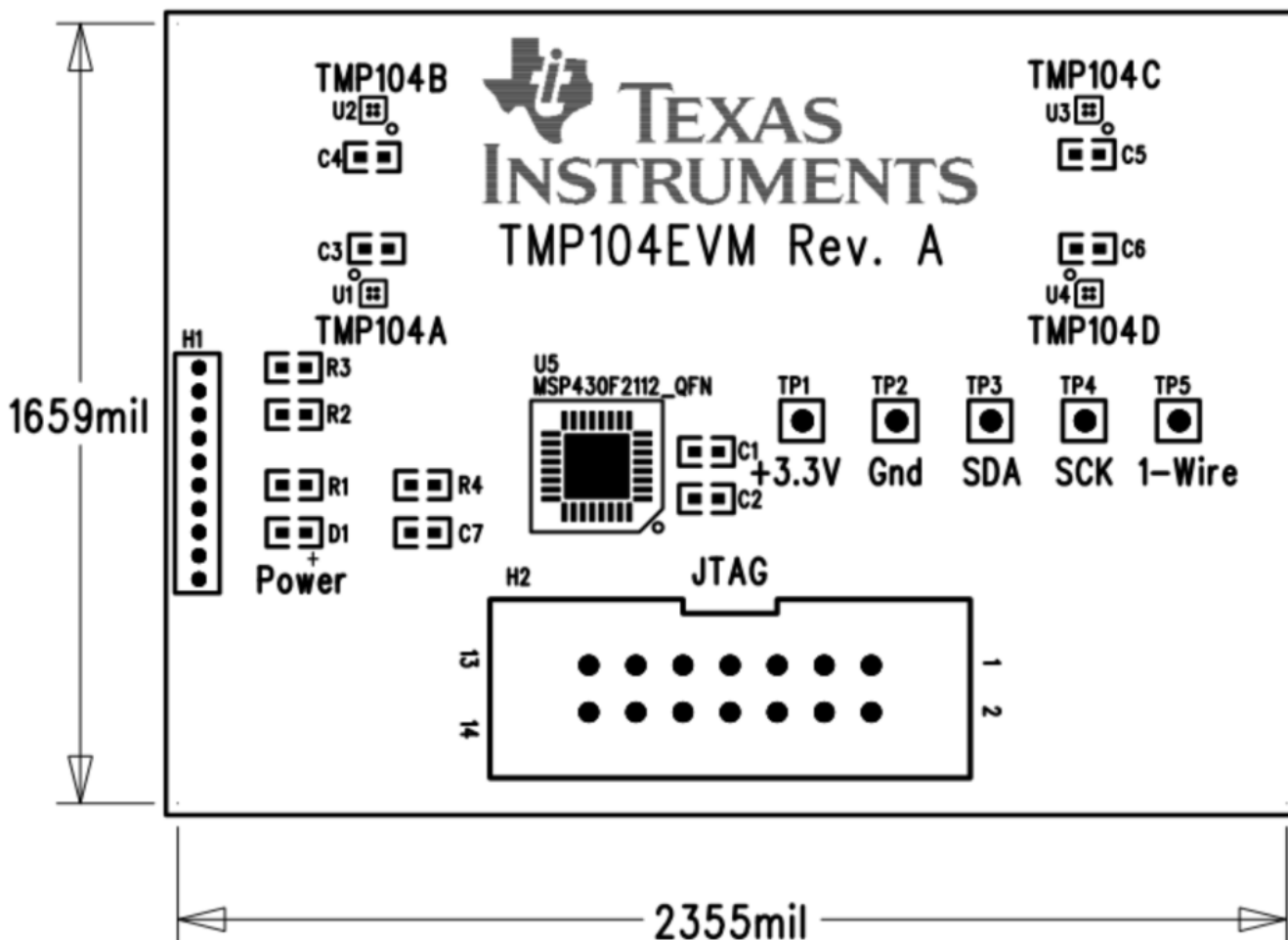

Figure 20. TMP104EVM PCB Top Layer (Component Layout)

6.3 Bill of Materials

Table 4 lists the bill of materials for the TMP104EVM.

Table 4. TMP104 Test Board Bill of Materials

Item No.	Qty	Value	Ref Des	Description	Vendor/Mfr	Part Number
1	1	MSP430F2112	U1	IC, MCU, 16-bit, 2K flash 32-QFN	Texas Instruments	MSP430F2112TRHBR
2	4	TMP104	U2 to U5	TMP104 ICs	Texas Instruments	TMP104
3	1	Test point	TP1	Test point PC mini .040"D red	Keystone	5000
4	1	Test point	TP2	Test point PC mini .040"D black	Keystone	5001
5	3	Test point	TP3 to TP5	Test point PC mini .040"D white	Keystone	5002
6	1	Header (10-pos)	H1	Connector, socket RT angle 10-pos .050	Mill-Max Manufacturing Corp.	851-93-010-20-001000
7	1	JTAG header	H2 (not installed)	Connector, header 14-pos DL STR gold	3M	30314-6002HB
8	1	LED	D1	LED 1 x 0.5 mm, 570 nm Gn wtr clr SMD	Kingbright Corp	APHHS1005CGCK
9	1	39 Ω	R1	Resistor, 39. Ω 1/10W 1% 0402 SMD	Panasonic - ECG	ERJ-2RKF39R0X
10	2	4.7 k Ω	R2, R3	Resistor, 4.7 Ω 1/16W 5% 0402 SMD	Stackpole Electronics Inc	RMCF0402JT4K70
11	1	47 k Ω	R4	Resistor, TF 47 k Ω 1% 1/16W 0402	Stackpole Electronics Inc	RMCF0402FT47K0
12	1	4.7 μ F	C1	Capacitor, ceramic, 4.7 μ F 6.3 V X5R 0402	Murata Electronics North America	GRM155R60J475ME87D
13	1	2.2 nF	C7	Capacitor, ceramic, 2200 pF 25 V X7R 0402	TDK Corporation	C1005X7R1E222M
14	4	Bump-ons	N/A	Bumpon, cylindrical .375 x .135 blk	3M	SJ61A8
15	5	0.1 μ F	C2 to C6	Capacitor, ceramic, 0.10 μ F X5R 10% 0402	TDK Corporation	C1005X5R1A104K

Evaluation Board/Kit Important Notice

Texas Instruments (TI) provides the enclosed product(s) under the following conditions:

This evaluation board/kit is intended for use for **ENGINEERING DEVELOPMENT, DEMONSTRATION, OR EVALUATION PURPOSES ONLY** and is not considered by TI to be a finished end-product fit for general consumer use. Persons handling the product(s) must have electronics training and observe good engineering practice standards. As such, the goods being provided are not intended to be complete in terms of required design-, marketing-, and/or manufacturing-related protective considerations, including product safety and environmental measures typically found in end products that incorporate such semiconductor components or circuit boards. This evaluation board/kit does not fall within the scope of the European Union directives regarding electromagnetic compatibility, restricted substances (RoHS), recycling (WEEE), FCC, CE or UL, and therefore may not meet the technical requirements of these directives or other related directives.

Should this evaluation board/kit not meet the specifications indicated in the User's Guide, the board/kit may be returned within 30 days from the date of delivery for a full refund. **THE FOREGOING WARRANTY IS THE EXCLUSIVE WARRANTY MADE BY SELLER TO BUYER AND IS IN LIEU OF ALL OTHER WARRANTIES, EXPRESSED, IMPLIED, OR STATUTORY, INCLUDING ANY WARRANTY OF MERCHANTABILITY OR FITNESS FOR ANY PARTICULAR PURPOSE.**

The user assumes all responsibility and liability for proper and safe handling of the goods. Further, the user indemnifies TI from all claims arising from the handling or use of the goods. Due to the open construction of the product, it is the user's responsibility to take any and all appropriate precautions with regard to electrostatic discharge.

EXCEPT TO THE EXTENT OF THE INDEMNITY SET FORTH ABOVE, NEITHER PARTY SHALL BE LIABLE TO THE OTHER FOR ANY INDIRECT, SPECIAL, INCIDENTAL, OR CONSEQUENTIAL DAMAGES.

TI currently deals with a variety of customers for products, and therefore our arrangement with the user **is not exclusive.**

TI assumes **no liability for applications assistance, customer product design, software performance, or infringement of patents or services described herein.**

Please read the User's Guide and, specifically, the Warnings and Restrictions notice in the User's Guide prior to handling the product. This notice contains important safety information about temperatures and voltages. For additional information on TI's environmental and/or safety programs, please contact the TI application engineer or visit www.ti.com/esh.

No license is granted under any patent right or other intellectual property right of TI covering or relating to any machine, process, or combination in which such TI products or services might be or are used.

FCC Warning

This evaluation board/kit is intended for use for **ENGINEERING DEVELOPMENT, DEMONSTRATION, OR EVALUATION PURPOSES ONLY** and is not considered by TI to be a finished end-product fit for general consumer use. It generates, uses, and can radiate radio frequency energy and has not been tested for compliance with the limits of computing devices pursuant to part 15 of FCC rules, which are designed to provide reasonable protection against radio frequency interference. Operation of this equipment in other environments may cause interference with radio communications, in which case the user at his own expense will be required to take whatever measures may be required to correct this interference.

EVM Warnings and Restrictions

It is important to operate this EVM within the input voltage range of 1.4 V to 3.6 V and the output voltage range of 1.4 V to 3.6 V .

Exceeding the specified input range may cause unexpected operation and/or irreversible damage to the EVM. If there are questions concerning the input range, please contact a TI field representative prior to connecting the input power.

Applying loads outside of the specified output range may result in unintended operation and/or possible permanent damage to the EVM. Please consult the EVM User's Guide prior to connecting any load to the EVM output. If there is uncertainty as to the load specification, please contact a TI field representative.

During normal operation, some circuit components may have case temperatures greater than +25°C. The EVM is designed to operate properly with certain components above +25°C as long as the input and output ranges are maintained. These components include but are not limited to linear regulators, switching transistors, pass transistors, and current sense resistors. These types of devices can be identified using the EVM schematic located in the EVM User's Guide. When placing measurement probes near these devices during operation, please be aware that these devices may be very warm to the touch.

Mailing Address: Texas Instruments, Post Office Box 655303, Dallas, Texas 75265
Copyright © 2011, Texas Instruments Incorporated

EVALUATION BOARD/KIT/MODULE (EVM) ADDITIONAL TERMS

Texas Instruments (TI) provides the enclosed Evaluation Board/Kit/Module (EVM) under the following conditions:

The user assumes all responsibility and liability for proper and safe handling of the goods. Further, the user indemnifies TI from all claims arising from the handling or use of the goods.

Should this evaluation board/kit not meet the specifications indicated in the User's Guide, the board/kit may be returned within 30 days from the date of delivery for a full refund. THE FOREGOING LIMITED WARRANTY IS THE EXCLUSIVE WARRANTY MADE BY SELLER TO BUYER AND IS IN LIEU OF ALL OTHER WARRANTIES, EXPRESSED, IMPLIED, OR STATUTORY, INCLUDING ANY WARRANTY OF MERCHANTABILITY OR FITNESS FOR ANY PARTICULAR PURPOSE. EXCEPT TO THE EXTENT OF THE INDEMNITY SET FORTH ABOVE, NEITHER PARTY SHALL BE LIABLE TO THE OTHER FOR ANY INDIRECT, SPECIAL, INCIDENTAL, OR CONSEQUENTIAL DAMAGES.

Please read the User's Guide and, specifically, the Warnings and Restrictions notice in the User's Guide prior to handling the product. This notice contains important safety information about temperatures and voltages. For additional information on TI's environmental and/or safety programs, please visit www.ti.com/esh or contact TI.

No license is granted under any patent right or other intellectual property right of TI covering or relating to any machine, process, or combination in which such TI products or services might be or are used. TI currently deals with a variety of customers for products, and therefore our arrangement with the user is not exclusive. TI assumes no liability for applications assistance, customer product design, software performance, or infringement of patents or services described herein.

REGULATORY COMPLIANCE INFORMATION

As noted in the EVM User's Guide and/or EVM itself, this EVM and/or accompanying hardware may or may not be subject to the Federal Communications Commission (FCC) and Industry Canada (IC) rules.

For EVMs **not** subject to the above rules, this evaluation board/kit/module is intended for use for ENGINEERING DEVELOPMENT, DEMONSTRATION OR EVALUATION PURPOSES ONLY and is not considered by TI to be a finished end product fit for general consumer use. It generates, uses, and can radiate radio frequency energy and has not been tested for compliance with the limits of computing devices pursuant to part 15 of FCC or ICES-003 rules, which are designed to provide reasonable protection against radio frequency interference. Operation of the equipment may cause interference with radio communications, in which case the user at his own expense will be required to take whatever measures may be required to correct this interference.

General Statement for EVMs including a radio

User Power/Frequency Use Obligations: This radio is intended for development/professional use only in legally allocated frequency and power limits. Any use of radio frequencies and/or power availability of this EVM and its development application(s) must comply with local laws governing radio spectrum allocation and power limits for this evaluation module. It is the user's sole responsibility to only operate this radio in legally acceptable frequency space and within legally mandated power limitations. Any exceptions to this are strictly prohibited and unauthorized by Texas Instruments unless user has obtained appropriate experimental/development licenses from local regulatory authorities, which is responsibility of user including its acceptable authorization.

For EVMs annotated as FCC – FEDERAL COMMUNICATIONS COMMISSION Part 15 Compliant

Caution

This device complies with part 15 of the FCC Rules. Operation is subject to the following two conditions: (1) This device may not cause harmful interference, and (2) this device must accept any interference received, including interference that may cause undesired operation.

Changes or modifications not expressly approved by the party responsible for compliance could void the user's authority to operate the equipment.

FCC Interference Statement for Class A EVM devices

This equipment has been tested and found to comply with the limits for a Class A digital device, pursuant to part 15 of the FCC Rules. These limits are designed to provide reasonable protection against harmful interference when the equipment is operated in a commercial environment. This equipment generates, uses, and can radiate radio frequency energy and, if not installed and used in accordance with the instruction manual, may cause harmful interference to radio communications. Operation of this equipment in a residential area is likely to cause harmful interference in which case the user will be required to correct the interference at his own expense.

FCC Interference Statement for Class B EVM devices

This equipment has been tested and found to comply with the limits for a Class B digital device, pursuant to part 15 of the FCC Rules. These limits are designed to provide reasonable protection against harmful interference in a residential installation. This equipment generates, uses and can radiate radio frequency energy and, if not installed and used in accordance with the instructions, may cause harmful interference to radio communications. However, there is no guarantee that interference will not occur in a particular installation. If this equipment does cause harmful interference to radio or television reception, which can be determined by turning the equipment off and on, the user is encouraged to try to correct the interference by one or more of the following measures:

- Reorient or relocate the receiving antenna.
- Increase the separation between the equipment and receiver.
- Connect the equipment into an outlet on a circuit different from that to which the receiver is connected.
- Consult the dealer or an experienced radio/TV technician for help.

For EVMs annotated as IC – INDUSTRY CANADA Compliant

This Class A or B digital apparatus complies with Canadian ICES-003.

Changes or modifications not expressly approved by the party responsible for compliance could void the user's authority to operate the equipment.

Concerning EVMs including radio transmitters

This device complies with Industry Canada licence-exempt RSS standard(s). Operation is subject to the following two conditions: (1) this device may not cause interference, and (2) this device must accept any interference, including interference that may cause undesired operation of the device.

Concerning EVMs including detachable antennas

Under Industry Canada regulations, this radio transmitter may only operate using an antenna of a type and maximum (or lesser) gain approved for the transmitter by Industry Canada. To reduce potential radio interference to other users, the antenna type and its gain should be so chosen that the equivalent isotropically radiated power (e.i.r.p.) is not more than that necessary for successful communication.

This radio transmitter has been approved by Industry Canada to operate with the antenna types listed in the user guide with the maximum permissible gain and required antenna impedance for each antenna type indicated. Antenna types not included in this list, having a gain greater than the maximum gain indicated for that type, are strictly prohibited for use with this device.

Cet appareil numérique de la classe A ou B est conforme à la norme NMB-003 du Canada.

Les changements ou les modifications pas expressément approuvés par la partie responsable de la conformité ont pu vider l'autorité de l'utilisateur pour actionner l'équipement.

Concernant les EVMs avec appareils radio

Le présent appareil est conforme aux CNR d'Industrie Canada applicables aux appareils radio exempts de licence. L'exploitation est autorisée aux deux conditions suivantes : (1) l'appareil ne doit pas produire de brouillage, et (2) l'utilisateur de l'appareil doit accepter tout brouillage radioélectrique subi, même si le brouillage est susceptible d'en compromettre le fonctionnement.

Concernant les EVMs avec antennes détachables

Conformément à la réglementation d'Industrie Canada, le présent émetteur radio peut fonctionner avec une antenne d'un type et d'un gain maximal (ou inférieur) approuvé pour l'émetteur par Industrie Canada. Dans le but de réduire les risques de brouillage radioélectrique à l'intention des autres utilisateurs, il faut choisir le type d'antenne et son gain de sorte que la puissance isotrope rayonnée équivalente (p.i.r.e.) ne dépasse pas l'intensité nécessaire à l'établissement d'une communication satisfaisante.

Le présent émetteur radio a été approuvé par Industrie Canada pour fonctionner avec les types d'antenne énumérés dans le manuel d'usage et ayant un gain admissible maximal et l'impédance requise pour chaque type d'antenne. Les types d'antenne non inclus dans cette liste, ou dont le gain est supérieur au gain maximal indiqué, sont strictement interdits pour l'exploitation de l'émetteur.

【Important Notice for Users of this Product in Japan】

This development kit is NOT certified as Confirming to Technical Regulations of Radio Law of Japan

If you use this product in Japan, you are required by Radio Law of Japan to follow the instructions below with respect to this product:

1. Use this product in a shielded room or any other test facility as defined in the notification #173 issued by Ministry of Internal Affairs and Communications on March 28, 2006, based on Sub-section 1.1 of Article 6 of the Ministry's Rule for Enforcement of Radio Law of Japan,
2. Use this product only after you obtained the license of Test Radio Station as provided in Radio Law of Japan with respect to this product, or
3. Use of this product only after you obtained the Technical Regulations Conformity Certification as provided in Radio Law of Japan with respect to this product. Also, please do not transfer this product, unless you give the same notice above to the transferee. Please note that if you could not follow the instructions above, you will be subject to penalties of Radio Law of Japan.

Texas Instruments Japan Limited
(address) 24-1, Nishi-Shinjuku 6 chome, Shinjuku-ku, Tokyo, Japan

<http://www.tij.co.jp>

【ご使用にあたっての注】

本開発キットは技術基準適合証明を受けておりません。

本製品のご使用に際しては、電波法遵守のため、以下のいずれかの措置を取っていただく必要がありますのでご注意ください。

1. 電波法施行規則第6条第1項第1号に基づく平成18年3月28日総務省告示第173号で定められた電波暗室等の試験設備でご使用いただく。
2. 実験局の免許を取得後ご使用いただく。
3. 技術基準適合証明を取得後ご使用いただく。

なお、本製品は、上記の「ご使用にあたっての注意」を譲渡先、移転先に通知しない限り、譲渡、移転できないものとします。

上記を遵守頂けない場合は、電波法の罰則が適用される可能性があることをご留意ください。

日本テキサス・インスツルメンツ株式会社
東京都新宿区西新宿6丁目2-4番1号
西新宿三井ビル

<http://www.tij.co.jp>

EVALUATION BOARD/KIT/MODULE (EVM) WARNINGS, RESTRICTIONS AND DISCLAIMERS

For Feasibility Evaluation Only, in Laboratory/Development Environments. Unless otherwise indicated, this EVM is not a finished electrical equipment and not intended for consumer use. It is intended solely for use for preliminary feasibility evaluation in laboratory/development environments by technically qualified electronics experts who are familiar with the dangers and application risks associated with handling electrical mechanical components, systems and subsystems. It should not be used as all or part of a finished end product.

Your Sole Responsibility and Risk. You acknowledge, represent and agree that:

1. You have unique knowledge concerning Federal, State and local regulatory requirements (including but not limited to Food and Drug Administration regulations, if applicable) which relate to your products and which relate to your use (and/or that of your employees, affiliates, contractors or designees) of the EVM for evaluation, testing and other purposes.
2. You have full and exclusive responsibility to assure the safety and compliance of your products with all such laws and other applicable regulatory requirements, and also to assure the safety of any activities to be conducted by you and/or your employees, affiliates, contractors or designees, using the EVM. Further, you are responsible to assure that any interfaces (electronic and/or mechanical) between the EVM and any human body are designed with suitable isolation and means to safely limit accessible leakage currents to minimize the risk of electrical shock hazard.
3. You will employ reasonable safeguards to ensure that your use of the EVM will not result in any property damage, injury or death, even if the EVM should fail to perform as described or expected.
4. You will take care of proper disposal and recycling of the EVM's electronic components and packing materials.

Certain Instructions. It is important to operate this EVM within TI's recommended specifications and environmental considerations per the user guidelines. Exceeding the specified EVM ratings (including but not limited to input and output voltage, current, power, and environmental ranges) may cause property damage, personal injury or death. If there are questions concerning these ratings please contact a TI field representative prior to connecting interface electronics including input power and intended loads. Any loads applied outside of the specified output range may result in unintended and/or inaccurate operation and/or possible permanent damage to the EVM and/or interface electronics. Please consult the EVM User's Guide prior to connecting any load to the EVM output. If there is uncertainty as to the load specification, please contact a TI field representative. During normal operation, some circuit components may have case temperatures greater than 60°C as long as the input and output are maintained at a normal ambient operating temperature. These components include but are not limited to linear regulators, switching transistors, pass transistors, and current sense resistors which can be identified using the EVM schematic located in the EVM User's Guide. When placing measurement probes near these devices during normal operation, please be aware that these devices may be very warm to the touch. As with all electronic evaluation tools, only qualified personnel knowledgeable in electronic measurement and diagnostics normally found in development environments should use these EVMs.

Agreement to Defend, Indemnify and Hold Harmless. You agree to defend, indemnify and hold TI, its licensors and their representatives harmless from and against any and all claims, damages, losses, expenses, costs and liabilities (collectively, "Claims") arising out of or in connection with any use of the EVM that is not in accordance with the terms of the agreement. This obligation shall apply whether Claims arise under law of tort or contract or any other legal theory, and even if the EVM fails to perform as described or expected.

Safety-Critical or Life-Critical Applications. If you intend to evaluate the components for possible use in safety critical applications (such as life support) where a failure of the TI product would reasonably be expected to cause severe personal injury or death, such as devices which are classified as FDA Class III or similar classification, then you must specifically notify TI of such intent and enter into a separate Assurance and Indemnity Agreement.

Mailing Address: Texas Instruments, Post Office Box 655303, Dallas, Texas 75265
Copyright © 2012, Texas Instruments Incorporated

IMPORTANT NOTICE

Texas Instruments Incorporated and its subsidiaries (TI) reserve the right to make corrections, enhancements, improvements and other changes to its semiconductor products and services per JESD46, latest issue, and to discontinue any product or service per JESD48, latest issue. Buyers should obtain the latest relevant information before placing orders and should verify that such information is current and complete. All semiconductor products (also referred to herein as "components") are sold subject to TI's terms and conditions of sale supplied at the time of order acknowledgment.

TI warrants performance of its components to the specifications applicable at the time of sale, in accordance with the warranty in TI's terms and conditions of sale of semiconductor products. Testing and other quality control techniques are used to the extent TI deems necessary to support this warranty. Except where mandated by applicable law, testing of all parameters of each component is not necessarily performed.

TI assumes no liability for applications assistance or the design of Buyers' products. Buyers are responsible for their products and applications using TI components. To minimize the risks associated with Buyers' products and applications, Buyers should provide adequate design and operating safeguards.

TI does not warrant or represent that any license, either express or implied, is granted under any patent right, copyright, mask work right, or other intellectual property right relating to any combination, machine, or process in which TI components or services are used. Information published by TI regarding third-party products or services does not constitute a license to use such products or services or a warranty or endorsement thereof. Use of such information may require a license from a third party under the patents or other intellectual property of the third party, or a license from TI under the patents or other intellectual property of TI.

Reproduction of significant portions of TI information in TI data books or data sheets is permissible only if reproduction is without alteration and is accompanied by all associated warranties, conditions, limitations, and notices. TI is not responsible or liable for such altered documentation. Information of third parties may be subject to additional restrictions.

Resale of TI components or services with statements different from or beyond the parameters stated by TI for that component or service voids all express and any implied warranties for the associated TI component or service and is an unfair and deceptive business practice. TI is not responsible or liable for any such statements.

Buyer acknowledges and agrees that it is solely responsible for compliance with all legal, regulatory and safety-related requirements concerning its products, and any use of TI components in its applications, notwithstanding any applications-related information or support that may be provided by TI. Buyer represents and agrees that it has all the necessary expertise to create and implement safeguards which anticipate dangerous consequences of failures, monitor failures and their consequences, lessen the likelihood of failures that might cause harm and take appropriate remedial actions. Buyer will fully indemnify TI and its representatives against any damages arising out of the use of any TI components in safety-critical applications.

In some cases, TI components may be promoted specifically to facilitate safety-related applications. With such components, TI's goal is to help enable customers to design and create their own end-product solutions that meet applicable functional safety standards and requirements. Nonetheless, such components are subject to these terms.

No TI components are authorized for use in FDA Class III (or similar life-critical medical equipment) unless authorized officers of the parties have executed a special agreement specifically governing such use.

Only those TI components which TI has specifically designated as military grade or "enhanced plastic" are designed and intended for use in military/aerospace applications or environments. Buyer acknowledges and agrees that any military or aerospace use of TI components which have **not** been so designated is solely at the Buyer's risk, and that Buyer is solely responsible for compliance with all legal and regulatory requirements in connection with such use.

TI has specifically designated certain components which meet ISO/TS16949 requirements, mainly for automotive use. Components which have not been so designated are neither designed nor intended for automotive use; and TI will not be responsible for any failure of such components to meet such requirements.

Products

Audio	www.ti.com/audio
Amplifiers	amplifier.ti.com
Data Converters	dataconverter.ti.com
DLP® Products	www.dlp.com
DSP	dsp.ti.com
Clocks and Timers	www.ti.com/clocks
Interface	interface.ti.com
Logic	logic.ti.com
Power Mgmt	power.ti.com
Microcontrollers	microcontroller.ti.com
RFID	www.ti-rfid.com
OMAP Applications Processors	www.ti.com/omap
Wireless Connectivity	www.ti.com/wirelessconnectivity

Applications

Automotive and Transportation	www.ti.com/automotive
Communications and Telecom	www.ti.com/communications
Computers and Peripherals	www.ti.com/computers
Consumer Electronics	www.ti.com/consumer-apps
Energy and Lighting	www.ti.com/energy
Industrial	www.ti.com/industrial
Medical	www.ti.com/medical
Security	www.ti.com/security
Space, Avionics and Defense	www.ti.com/space-avionics-defense
Video and Imaging	www.ti.com/video

TI E2E Community

e2e.ti.com