

# TVP5151 Evaluation Module

## User's Guide



Literature Number: SLEU106  
November 2009



<b>1</b>	<b>Description</b> .....	<b>6</b>
1.1	Functional Overview .....	6
<b>2</b>	<b>Board-Level Description</b> .....	<b>7</b>
2.1	Analog Video Inputs .....	7
2.2	Analog Component Video Output .....	7
2.3	USB Interface and Power .....	8
2.4	Board Jumpers .....	8
2.5	Test Points .....	8
2.6	TVP5151 Crystal Requirements .....	9
<b>3</b>	<b>Software Installation</b> .....	<b>10</b>
3.1	Uninstalling Previous Version .....	10
3.2	TVP5151EVM Software Installation .....	10
<b>4</b>	<b>Hardware Setup</b> .....	<b>13</b>
<b>5</b>	<b>VCC Operation</b> .....	<b>14</b>
5.1	Getting Started .....	14
5.2	Starting the VCC Application Program .....	14
5.3	VCC6 Configuration Dialog Box .....	14
5.4	USB I <sup>2</sup> C System Test .....	15
5.5	Real-Time Polling .....	15
5.6	Main Menu .....	16
5.7	System Initialization .....	16
5.8	Command Files .....	17
5.9	Register Editing .....	20
5.10	Property Sheets .....	22
<b>6</b>	<b>Troubleshooting the TVP5151EVM</b> .....	<b>26</b>
6.1	Troubleshooting Guide .....	26
6.2	Resolving I <sup>2</sup> C Communication Problems .....	27
<b>7</b>	<b>TVP5151EVM Schematics</b> .....	<b>28</b>

## List of Figures

1	TVP5151EVM Board Layout .....	7
2	P1 Header Pinout .....	9
3	PCB Crystal Footprint.....	10
4	TVP5151EVM Software Setup Wizard .....	11
5	Select Installation Folder .....	11
6	Confirm Installation.....	12
7	Installation Complete.....	12
8	Typical Hardware Setup .....	13
9	VCC Configuration Dialog .....	14
10	USB Error.....	15
11	Real-Time Polling.....	15
12	Main Menu.....	16
13	System Initialization .....	17
14	Example CMD File .....	19
15	TVP5151 Register Map Editor .....	20
16	THS8200 Register Map Editor.....	21
17	Generic I2C Register Map Editor.....	22
18	TVP5151 Analog Video Property Sheet .....	22
19	TVP5151 Video Format Property Sheet.....	23
20	TVP5151 Video Decoder Status Property Sheet.....	24
21	THS8200 Input Controls Property Sheet .....	24
22	TVP5151 I <sup>2</sup> C Error Report.....	27
23	THS8200 I <sup>2</sup> C Error Report.....	27
24	USB Link Error .....	27
25	Schematic - Power .....	29
26	Schematic - YPbPr Out .....	30
27	Schematic - Video In.....	31

## List of Tables

1	Jumper Settings .....	8
2	Test Points .....	8
3	Main Menu Summary .....	16
4	Register Map Editor Controls .....	20
5	Use of Property Sheet Controls .....	23
6	Property Sheet Button Controls .....	23
7	Troubleshooting Guide.....	26

## ***TVP5151 Evaluation Module***

---

---

---

### **1 Description**

The TVP5151EVM is a four-layer printed circuit board designed for evaluation of the TVP5151 PAL/NTSC/SECAM video decoder. A THS8200 triple DAC is included on the circuit board to convert the ITU-R BT.656 YCbCr digital output from the TVP5151 to YPbPr component video. Two composite video (CVBS) input connectors and one YPbPr component video output connector are provided on the board for input and output connections. I<sup>2</sup>C communication with the EVM is provided by a host PC USB port and the VCC (Video Control Center) software tool provided with the EVM. All required power for TVP5151EVM is supplied by the USB port. This user's guide outlines the necessary hardware and software setup required to provide full evaluation of the TVP5151.

#### **1.1 Functional Overview**

The TVP5151EVM uses a host PC USB port to emulate the I<sup>2</sup>C bus, providing communication with the TVP5151 video decoder and the THS8200 encoder. The VCC application software provided on the TVP5151EVM CR-ROM communicates with the devices via the PC USB port.

The analog video inputs supported by the TVP5151AEVM include two composite video inputs. In general, the video decoder converts the analog video input signal into 8-bit ITU-R BT.656 YCbCr digital component data. This data and the associated clock from the video decoder are sent to the THS8200 for conversion to analog YPbPr component video.

To experiment with the programmable features of the TVP5151 video decoder and the THS8200, the USB port of the TVP5151EVM is connected to the USB port of a PC. VCC, a Windows™ compatible application, provides the user interface for performing register-level and high-level control of the TVP5151 video decoder and the THS8200 encoder DAC. A PAL or NTSC composite video source and a monitor capable of displaying YPbPr component video are required for evaluation.

## 2 Board-Level Description

Figure 1 illustrates the primary components on the TVP5151EVM.

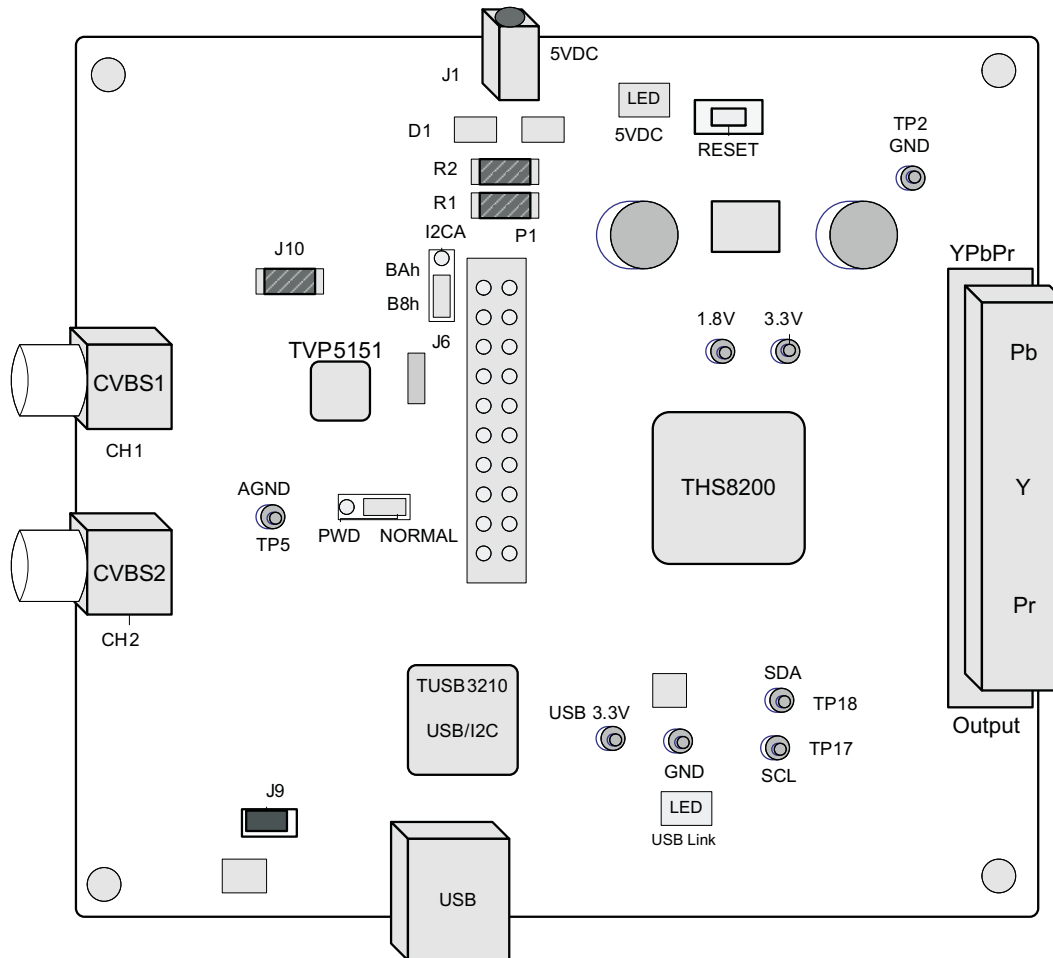

Figure 1. TVP5151EVM Board Layout

### 2.1 Analog Video Inputs

Two RCA video connectors are provided for connecting NTSC or PAL composite video sources to the TVP5151EVM. CH1 is connected to the AIP1A input of the TVP5151, while CH2 is connected to the AIP1B input. Both video inputs pass through anti-alias filters, termination resistors, and AC coupling capacitors prior to connecting to the TVP5151 input. CH1 is the default channel selected by the TVP5151 input MUX and EVM software and is the recommended input when connecting a single video source. S-video can be supported by connecting the Y (luminance) input to CH1 and the C (chrominance) input to CH2.

### 2.2 Analog Component Video Output

RCA connectors are provided for connecting the YPbPr component video output to a suitable monitor. The component video outputs are driven by the THS8200 DAC through filters similar to those used for the composite video inputs. The THS8200 output and filters are designed for a 75-Ω video load. When viewing the outputs on an oscilloscope, the component video outputs must be properly terminated with 75 Ω for correct output levels. Composite video out is not supported with the TVP5151EVM.

### 2.3 USB Interface and Power

A USB cable must be connected between the host PC and TVP5151EVM. The USB interface cable provides the I<sup>2</sup>C communication required to program the TVP5151 and THS8200 and also provides the 5-V power required for the TVP5151EVM. An optional power jack (J1) is provided on the board to allow use of a separate power supply if desired. If a separate 5-V power supply is used, R1 and R2 must be removed from the TVP5151EVM and D1 installed. The USB interface circuitry remains powered by the USB interface, if this separate supply is used. Voltage regulators on the EVM are used to generate the 1.8-V and 3.3-V levels required for the components on the board. LEDs are included on the board to indicate the presence of 5-V power and USB connectivity.

### 2.4 Board Jumpers

The TVP5151 provides support for either 1.8-V or 3.3-V I/O levels. The I/O levels used by the TVP5151EVM can be selected by moving the 0-Ω SMT resistor at J2. The EVM is shipped from the factory with 3.3-V I/O selected. The J2 setting affects all digital I/O levels on the TVP5151EVM, including the TVP5151, THS8200, I<sup>2</sup>C, and RESET.

The J7 power-down jumper can be used to place the TVP5151 in a low-power state. In this power-down state, the TVP5151 I<sup>2</sup>C is not functional. See [Table 1](#) for a summary of jumper options.

**Table 1. Jumper Settings**

Jumper Designator	Function	Default Setting	Comment
J2	1.8-V/3.3-V I/O select	3.3-V	Selects TVP5151, THS8200, and I <sup>2</sup> C I/O levels, 0-Ω SMT
J6	TVP5151 I2CA select	B8h	TVP5151 I <sup>2</sup> C address, 0-Ω SMT
J7	TVP5151 power down	1-2, normal operation	I <sup>2</sup> C disabled during power down
J9	Reserved for test	Installed	Must be installed for USB I <sup>2</sup> C functionality
J10	Analog/digital GND connection	Installed	0-Ω SMT
J11	Analog/digital GND connection	Not installed	Optional

### 2.5 Test Points

Test points are provided on the TVP5151EVM to assist in evaluation of the TVP5151. All TVP5151 digital outputs are brought out to the P1 dual row header that can be used for testing and external connections. See [Table 2](#) and [Figure 2](#) for available test points.

**Table 2. Test Points**

Test Point Designator	Function	Comment
TP1	3.3 V	Main 3.3-V supply for the board
TP2, TP19	DGND	Digital ground
TP3	1.8 V	Main 1.8-V supply for the board
TP5	AGND	Analog ground
TP17	SDA	I <sup>2</sup> C data
TP18	SCL	I <sup>2</sup> C clock



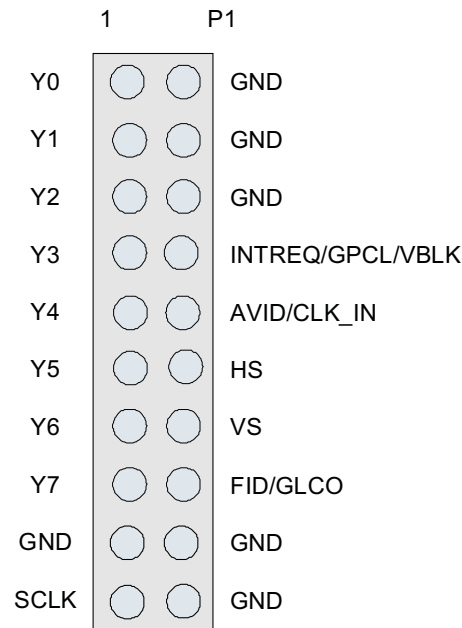

Figure 2. P1 Header Pinout

## 2.6 TVP5151 Crystal Requirements

The TVP5151EVM is shipped from the factory with a 5.0-mm x 3.2-mm 27-MHz crystal installed. An additional footprint is also included on the PCB (see Figure 3) for evaluation of smaller 2.0-mm x 1.6-mm crystals. This smaller crystal is a 4-pin device and must be oriented correctly on the EVM. C62 and C59 are load capacitors for the crystal and must be sized according to the specification of the crystal used. The TVP5151EVM is shipped from the factory with 33-pF load capacitors installed in support of the crystal used. The frequency stability of the crystal used must be within  $\pm 50$  ppm.

The TVP5151 also supports the use of a 27-MHz oscillator or clock source via connections to either the XTAL1/OSC or AVID\_CLK\_IN pins. 1.8-V logic levels must be used when connecting a clock source to the XTAL1/OSC pin of the TVP5151. Clock sources with 3.3-V output levels are supported by the AVID/CLK\_IN pin, but only when jumper J2 is configured for 3.3-V I/O. Additionally, the XTAL1/OSC pin must be tied to GND to activate AVID/CLK\_IN clock functionality. The XTAL1/OSC pin can be grounded by replacing C62 with a 0- $\Omega$  resistor.

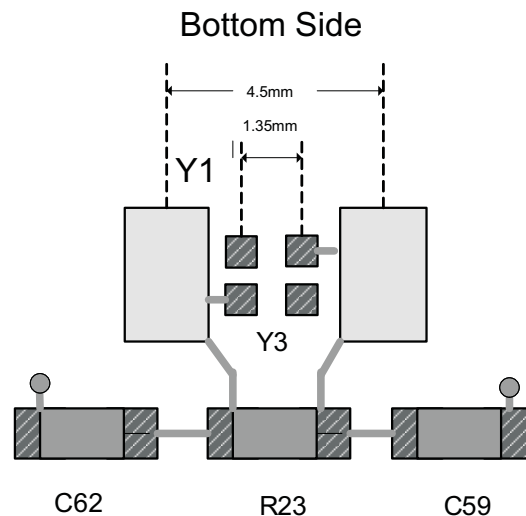

Figure 3. PCB Crystal Footprint

### 3 Software Installation

This section summarizes the steps for setup and operation of the TVP5151EVM. If TVP5151EVM software has been previously installed on the PC, you will be prompted to first uninstall the previous version.

#### 3.1 Uninstalling Previous Version

To uninstall a previous version of TVP5151EVM software:

1. Click Start > Control Panel > Add or Remove Programs; wait for the list to populate.
2. Find and select "TVP5151EVM Software".
3. Click the remove button.
4. When prompted with "Are you sure you want to remove the TVP5151EVM Software from your computer?", click Yes.

#### 3.2 TVP5151EVM Software Installation

The TVP5151EVM Software package includes the Windows Control Center (VCC) application, device initialization files, and documentation. This must be installed from the enclosed CD-ROM onto the PC that will be used to control the TVP5151EVM via the PC USB port.

To install the software:

1. Insert the CD-ROM into the computer that will emulate the I<sup>2</sup>C bus via the USB port.
2. Run SETUP.EXE to install TVP5151EVM software and documentation.
3. Click Next at all prompts and click Finish to complete the installation process (see [Figure 4](#) through [Figure 7](#)).



**Figure 4. TVP5151EVM Software Setup Wizard**

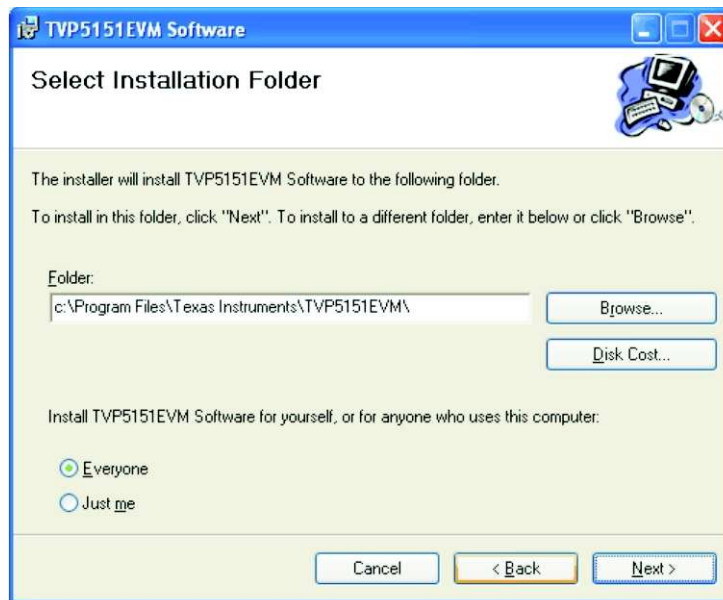

**Figure 5. Select Installation Folder**

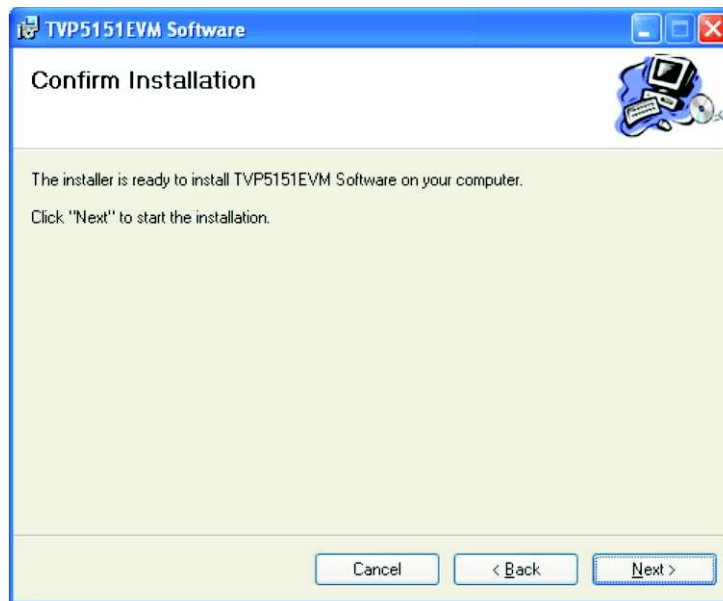

**Figure 6. Confirm Installation**

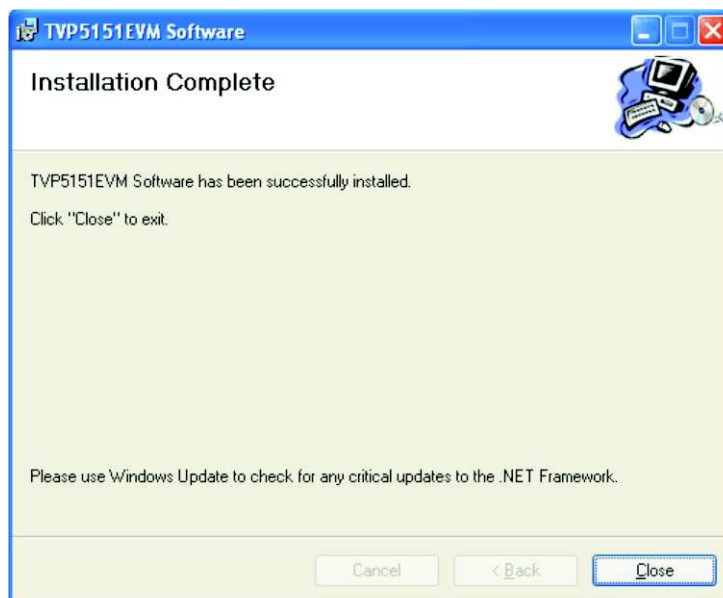

**Figure 7. Installation Complete**

Documentation and a shortcut to the TVP5151EVM VCC application are installed in the Windows Start menu at:

- Start > All Programs > TVP5151EVM > TVP5151EVM User Guide
- Start > All Programs > TVP5151EVM > TVP5151EVM Software

## 4 Hardware Setup

Figure 8 shows a typical TVP5151EVM setup used for evaluation.

### Required Equipment

- TVP5151EVM
- NTSC or PAL composite video source such as a test generator or DVD
- Composite video cable
- USB cable
- YPbPr component video cable
- NTSC or PAL monitor with YPbPr component input
- Host PC with TVP5151EVM software installed

To prepare the EVM for evaluation, connect the following:

- USB cable from the host PC to the TVP5151EVM
- Analog composite video source to CH1 of the TVP5151EVM
- Analog component video output to an NTSC or PAL compatible monitor.

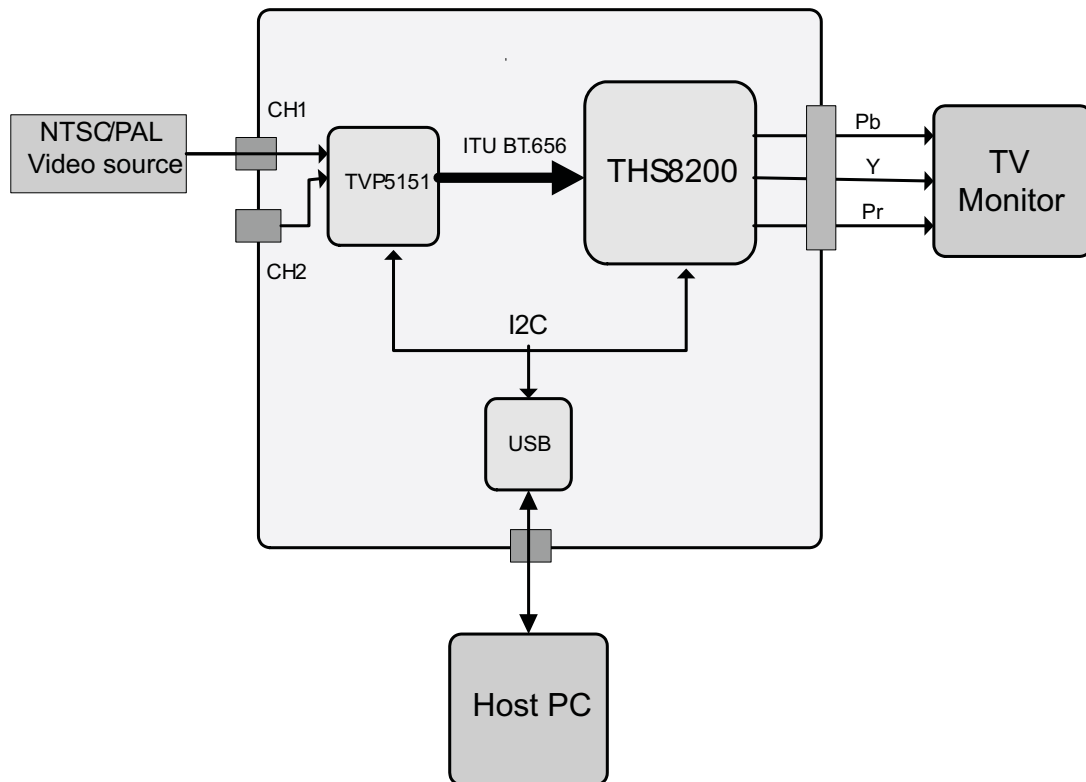

Figure 8. Typical Hardware Setup

## 5 VCC Operation

This section describes operation of the TVP5151EVM VCC6 software.

### 5.1 Getting Started

After software installation (see [Section 3](#)) and hardware configuration (see [Section 4](#)) have been completed, VCC may be started for evaluation of the TVP5151EVM.

### 5.2 Starting the VCC Application Program

The VCC6 (Windows™ Video Control Center) application program must have been previously installed on the PC. Run VCC6 from the Windows Start Menu:

Start > Programs > TVP5151EVM > TVP5151EVM Software

### 5.3 VCC6 Configuration Dialog Box

The VCC Configuration dialog box, as shown in [Figure 9](#), should now be visible. All settings from this dialog box are stored in the Windows registry and are restored the next time the program is started. After initial installation, VID\_DEC should be set to TVP5151 and the THS8200 selected for DAC output.

The I<sup>2</sup>C slave addresses for each device must match the I<sup>2</sup>C slave address configured on the TVP5151EVM. This TVP5151EVM is configured by the factory to use I<sup>2</sup>C address B8h for the TVP5151 and 40h for the THS8200.

It is important to select the correct specific device type. TVP5151 and THS8200 must be selected for the TVP5151EVM.

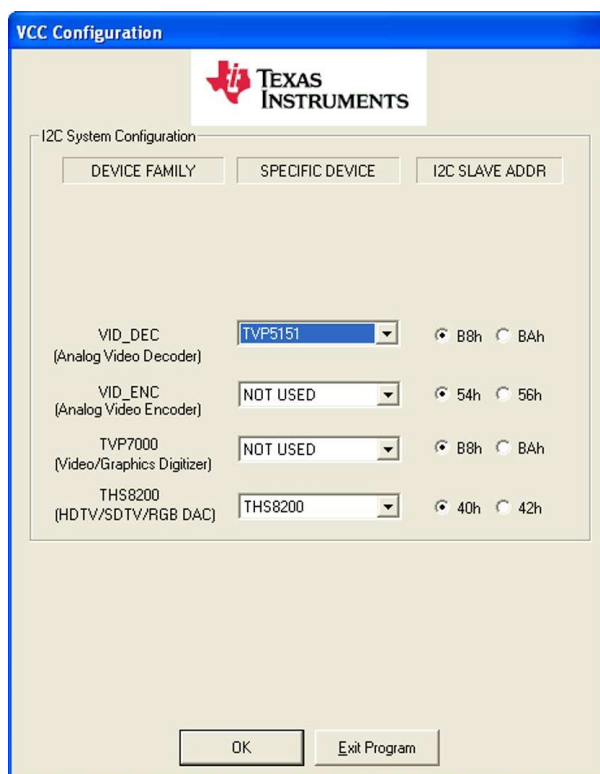

**Figure 9. VCC Configuration Dialog**

Click on OK to proceed and begin USB I<sup>2</sup>C communication with the selected devices.

## 5.4 USB PC System Test

If a message occurs indicating that the USB device was not found (see [Figure 10](#)), disconnect the USB cable, wait three seconds, reconnect the USB cable, and click Continue.

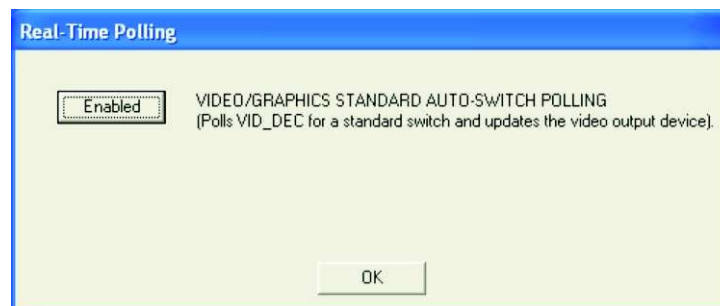

**Figure 10. USB Error**

If the USB device is still not found, see [Section 6](#). If the USB link is functioning properly the Real-Time Polling dialog box shown in [Figure 11](#) appears.

## 5.5 Real-Time Polling

If the USB link is functioning properly, the Real-Time Polling dialog box in [Figure 11](#) appears. When real-time polling is enabled, VCC monitors the composite input format and automatically programs the THS8200 when the input format changes.



**Figure 11. Real-Time Polling**

When enabled, real-time polling provides polling functions that continuously execute in the background. When TVP5151 detects a change in the input video standard, it automatically switches to operation in the detected standard (which includes all necessary I<sup>2</sup>C register initialization) for proper decoding of the input video. To enable auto-switch on the TVP5151, the Set Video Standard register must be set to auto-switch mode (register 0x28 = 0x00).

If the VCC auto-switch polling function is enabled, the detected video standard status from the TVP5151 is polled until a change in the input video standard is detected. When a change is detected, the THS8200 is reprogrammed as needed for the detected standard. Using this feature, the video source can change its video standard and the system displays using the new standard without user intervention.

To enable auto-switch polling (recommended), the video-standard auto-switch polling function must be enabled in the real-time polling dialog (see [Figure 11](#)). The real-time polling dialog can also be accessed when VCC is running by clicking Real-Time Polling in the Tools menu.

Click on OK to proceed with Real-Time Polling enabled.

## 5.6 Main Menu

After closing the real-time polling dialog, the Main Menu is displayed as shown in [Figure 12](#). The menus, which are used to operate VCC, are File, Edit, Tools, Window, and Help. The File menu's only function is Exit, which terminates the program. [Table 3](#) is a summary of the main menu contents.

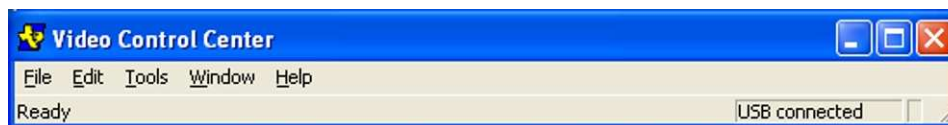

**Figure 12. Main Menu**

**Table 3. Main Menu Summary**

Menu	Contents
File	Exit VCC6
Edit	Register Map Editor
	Property Sheets
Tools	System Initialization
	Real-time Polling
	USB/LPT I <sup>2</sup> C Options
Window	Allows selection of the active window. Multiple windows can be open at the same time. Initially the Window menu is empty.
Help	About VCC

## 5.7 System Initialization

Clicking System Initialization in the Tools menu displays the dialog shown in [Figure 13](#). This provides the means for initializing the video decoder and/or video encoder for a particular video mode. The details of the initialization are contained in the command file (with a CMD file extension).

The command file is opened using the Browse... button. Once the command file is opened, a text list displays descriptions of the individual "data sets" contained within the command file.

Click once on the desired data set description to select it. Click the Program Device(s) Using Selected Dataset button to run the selected data set, which loads the devices via the I<sup>2</sup>C bus. When the device initialization has completed, the status indicator reads Ready.

---

**NOTE:** If Ready does not display, then the devices are not initialized and the I<sup>2</sup>C bus is not communicating. See [Section 6](#) for a solution.

Click the OK button to close the dialog box.

---



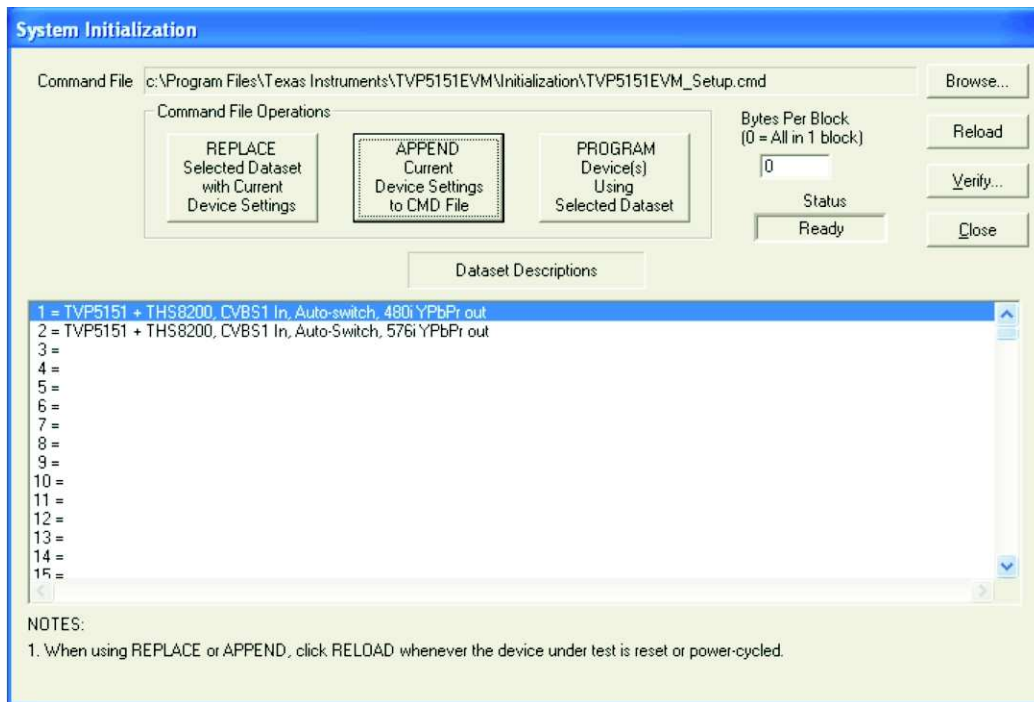

**Figure 13. System Initialization**

## 5.8 Command Files

The command file is a text file which can be generated using any common editor; however, it must be saved as plain text. Command files are especially useful for testing and comparing various changes in the device setup.

A default command file, which should contain most of the desired setups, has been installed with the EVM software. After installation, when the system initialization tool is opened, the default command file is selected. This command file is located at:

C:\Program Files\Texas Instruments\TVP5151EVM\Initialization\TVP5151EVM\_Setup.cmd

A command file can contain up to 250 data sets. A data set is a set of register settings to initialize the video decoder and/or video encoder for a particular video mode. Each data set includes a description that is displayed in one row of the dataset descriptions list. The register settings may be located in the command file itself and/or may be stored in separate include file(s) (with an INC file extension) and be included into the command file using the INCLUDE statement.

### 5.8.1 Example Command File

An example of one data set within a command file is shown in [Figure 14](#). Each command file may contain individual write to register (WR\_REG) commands or include these commands from a separate INC file or both. The purpose of the INCLUDE feature is to avoid repeating a long list of register settings many times in a command file and having to maintain that list.

#### Command File Syntax

1. The comment indicator is the double-slash "//".
2. The command file is not case-sensitive and ignores all white-space characters.
3. All numbers can be entered as hexadecimal (beginning with 0x) or as decimal.
4. Every data set in a command file begins with BEGIN\_DATASET and ends with END\_DATASET. The maximum number of data sets is 250.

5. The data set text description is entered between double quotes using the DATASET\_NAME command. The enclosed text can be up to 128 characters in length. This text appears in the system initialization dialog when the command file is opened.
6. The INCLUDE command inserts the contents of an include file (with an INC file extension) in-line in place of the INCLUDE command. Therefore, the include file should not contain the BEGIN\_DATASET, END\_DATASET, and DATASET\_NAME commands.
7. The write to register command is written as follows:  
WR\_REG, <DeviceFamily>, <Number of data bytes (N)>, <subaddress>, <Data1>, ..., <DataN>  
or  
WR\_REG, <Literal slave address>, <Number of data bytes (N)>, <subaddress>, <Data1>, ..., <DataN>
8. The valid device family mnemonics are:  
VID\_DEC for the video decoders  
THS8200 for the THS8200 device
9. VCC6 translates the device family mnemonic to the slave address that was selected on the VCC6 configuration dialog upon program startup. This eliminates having to edit command files if the alternate slave address must be used.
10. If the literal slave address method is used, the slave address entered is used directly.
11. A delay may be inserted between commands using the WAIT command:  
WAIT, <# milliseconds>

---

**NOTE:** All included files must be located in the same directory as the command (CMD) file.

---

```
BEGIN_DATASET
```

```
DATASET_NAME, "NTSC in, 480i60 YPbPr out"
//TVP5151
WR_REG,VID_DEC,1,0x03,0x69 // GPCL HIGH, YUV output enable
WR_REG,VID_DEC,1,0x07,0x20 // Pestal control on

//THS8200
WR_REG,THS8200,0x01,0x03,0x11 // chip_ctl
WR_REG,THS8200,0x01,0x1C,0x04 // dman_cnt1
WR_REG,THS8200,0x01,0x1D,0x00 // dtg_y_sync1
WR_REG,THS8200,0x01,0x1E,0x49 // dtg_y_sync2
WR_REG,THS8200,0x01,0x1F,0x00 // dtg_y_sync3
WR_REG,THS8200,0x01,0x20,0x00 // dtg_cbcr_sync1
WR_REG,THS8200,0x01,0x21,0x00 // dtg_cbcr_sync2
WR_REG,THS8200,0x01,0x22,0x00 // dtg_cbcr_sync3
WR_REG,THS8200,0x01,0x23,0x22 // dtg_y_sync_upper
WR_REG,THS8200,0x01,0x24,0x2A // dtg_cbcr_sync_upper
WR_REG,THS8200,0x01,0x25,0x3E // dtg_spec_a
WR_REG,THS8200,0x01,0x26,0x14 // dtg_spec_b
WR_REG,THS8200,0x01,0x27,0x1E // dtg_spec_c
WR_REG,THS8200,0x01,0x28,0x79 // dtg_spec_d
WR_REG,THS8200,0x01,0x29,0x00 // dtg_spec_d1
WR_REG,THS8200,0x01,0x2A,0x00 // dtg_spec_e
WR_REG,THS8200,0x01,0x2B,0x01 // dtg_spec_h_msb
WR_REG,THS8200,0x01,0x2C,0x6B // dtg_spec_h_lsb
WR_REG,THS8200,0x01,0x2D,0x03 // dtg_spec_i_msb
WR_REG,THS8200,0x01,0x2E,0x1B // dtg_spec_i_lsb
WR_REG,THS8200,0x01,0x2F,0x11 // dtg_spec_k_lsb
WR_REG,THS8200,0x01,0x30,0x00 // dtg_spec_k_msb
WR_REG,THS8200,0x01,0x31,0x0A // dtg_spec_k1
WR_REG,THS8200,0x01,0x32,0xAD // dtg_speg_g_lsb
WR_REG,THS8200,0x01,0x33,0x01 // dtg_speg_g_msb
WR_REG,THS8200,0x01,0x34,0x03 // dtg_total_pixel_msb
WR_REG,THS8200,0x01,0x35,0x5A // dtg_total_pixel_lsb
```

```

WR_REG,THS8200,0x01,0x36,0x00 // dtg_linecnt_msb
WR_REG,THS8200,0x01,0x37,0x01 // dtg_linecnt_lsb
WR_REG,THS8200,0x01,0x38,0x84 // dtg_mode
WR_REG,THS8200,0x01,0x39,0x21 // dtg_frame_field_msb
WR_REG,THS8200,0x01,0x3A,0x0D // dtg_frame_size_lsb
WR_REG,THS8200,0x01,0x3B,0x07 // dtg_field_size_lsb
WR_REG,THS8200,0x01,0x3C,0x80 // dtg_vesa_cbar_size
WR_REG,THS8200,0x01,0x41,0x40 // csm_clip_gy_low
WR_REG,THS8200,0x01,0x42,0x40 // csm_clip_bcb_low
WR_REG,THS8200,0x01,0x43,0x40 // csm_clip_rcr_low
WR_REG,THS8200,0x01,0x44,0x53 // csm_clip_gy_high
WR_REG,THS8200,0x01,0x45,0x3F // csm_clip_bcb_high
WR_REG,THS8200,0x01,0x46,0x3F // csm_clip_rcr_high
WR_REG,THS8200,0x01,0x47,0x40 // csm_shift_gy
WR_REG,THS8200,0x01,0x48,0x40 // csm_shift_bcb
WR_REG,THS8200,0x01,0x49,0x40 // csm_shift_rcr
WR_REG,THS8200,0x01,0x4A,0xFC // csm_mult_gy_msb
WR_REG,THS8200,0x01,0x4B,0x44 // csm_mult_bcb_rcr_msb
WR_REG,THS8200,0x01,0x4C,0xAC // csm_mult_gy_lsb
WR_REG,THS8200,0x01,0x4D,0x91 // csm_mult_bcb_lsb
WR_REG,THS8200,0x01,0x4E,0x91 // csm_mult_rcr_lsb
WR_REG,THS8200,0x01,0x4F,0xFF // csm_mode
WR_REG,THS8200,0x01,0x70,0x40 // dtg_hlength_lsb
WR_REG,THS8200,0x01,0x71,0x03 // dtg_hdly_msb
WR_REG,THS8200,0x01,0x72,0x59 // dtg_hdly_lsb
WR_REG,THS8200,0x01,0x73,0x04 // dtg_vlength_lsb
WR_REG,THS8200,0x01,0x74,0x00 // dtg_vdly_msb
WR_REG,THS8200,0x01,0x75,0x04 // dtg_vdly_lsb
WR_REG,THS8200,0x01,0x76,0x04 // dtg_vlength2_lsb
WR_REG,THS8200,0x01,0x77,0x01 // dtg_vdly2_msb
WR_REG,THS8200,0x01,0x78,0x0B // dtg_vdly2_lsb
WR_REG,THS8200,0x01,0x79,0x00 // dtg_hs_in_dly_msb
WR_REG,THS8200,0x01,0x7A,0x44 // dtg_hs_in_dly_lsb
WR_REG,THS8200,0x01,0x7B,0x00 // dtg_vs_in_dly_msb
WR_REG,THS8200,0x01,0x7C,0x00 // dtg_vs_in_dly_lsb
WR_REG,THS8200,0x01,0x82,0x27 // pol_cntl

END_DATASET

```

**Figure 14. Example CMD File**

### 5.8.2 Adding a Custom Data Set to a CMD File

To create a custom dataset, program the EVM via the system initialization tool using the factory-supplied command file. Through the property sheets tool or I<sup>2</sup>C Register Map Editor you can then customize the device register settings to suit your needs and save the settings as a new dataset. To save your custom settings:

1. Open the System Initialization dialog via the Tools menu.
2. Click Append Current Device Settings to Command File. A dialog requesting a description on the new data set appears.
3. Optionally, click the dropdown box and select one of the existing descriptions.
4. Modify the description text or type a new description.
5. Click OK. All non-default register values are read from the TVP5151 and THS8200 and are appended to the current command file as an additional data set.
6. Select the custom data set and press the Program button to send.

## 5.9 Register Editing

The next sections describe the two available modes of register editing: register map editors and property sheets. Each of these functions can be selected from the Edit menu.

### 5.9.1 TVP5151 Register Map Editor

The register map editor, as shown in Figure 15, allows the display and editing of the entire used register space of the device within a simple scrolling text box. To open this, click on Edit Register Map in the Edit menu and click on the device type to edit. Table 4 describes how to use each of the controls in the register map editor.

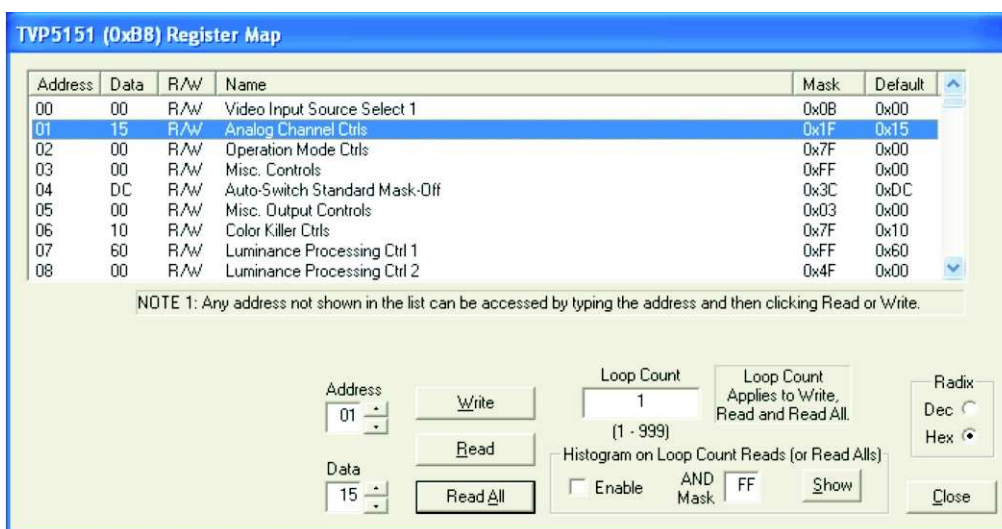

Figure 15. TVP5151 Register Map Editor

Table 4. Register Map Editor Controls

Control	Definition
Register Window	Scrolling text box that displays the address and data for the I <sup>2</sup> C registers that are defined for the device.
Address Edit Box	This contains the I <sup>2</sup> C subaddress that is accessed using the Write and Read buttons. Clicking on a row selects an address, which then appears in the address edit box. <b>NOTE:</b> After clicking on a row, the Data Edit Box contains the data that was in the register window. This data may not correspond to the actual data in the device (until Read or Read All is clicked). The address up/down arrows are used to jump to the next/previous subaddress that is defined for the device. <b>NOTE:</b> If an address is not defined for the device, it can still be accessed by typing the subaddress in the Address Edit Box.
Data Edit Box	This contains the data to be written to or read from the I <sup>2</sup> C subaddress. The data up/down arrows increases / decreases the data value by 1.
Write Button	Writes the byte in the Data Edit Box to the address in the Address Edit box. The I <sup>2</sup> C register is written to whether or not the data is different from the last time the register was read.
Read Button	Reads the data from the address in the Address Edit Box into the Data Edit box and the register window.
Read All Button	Reads all defined readable registers from the device and updates the register window.
Hex Button	Displays all values in the register window and address and data edit boxes in hexadecimal format.
Dec Button	Displays all values in the register window and address and data edit boxes in decimal format.
Close Button	Closes the dialog. <b>NOTE:</b> Multiple edit register map windows can be open at the same time (one for each device). Use the Window menu to navigate.
Loop Count	Causes subsequent write or read operations to be performed N times. N is entered as a decimal number from 1 to 999. Opens the indirect register editor of the TVP5151.

**NOTE:** To save current register settings to a file, check the Histogram Enable check box and click Read All. Click Show to view the saved file.

### 5.9.2 THS8200 Register Map Editor

The THS8200 register editor, as shown in Figure 16, allows the display and editing of the THS8200 registers. This editor works like the TVP5151 editor.

To open this, click on Edit Register Map in the Edit menu and click on THS8200.

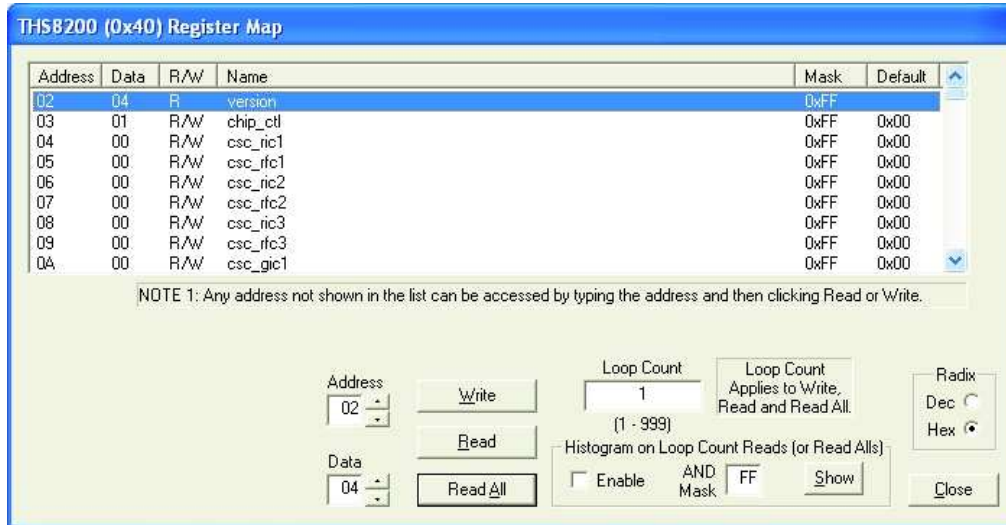

Figure 16. THS8200 Register Map Editor

### 5.9.3 Generic I<sup>2</sup>C Register Editor

The Generic I<sup>2</sup>C Editor, as shown in Figure 17, allows the display and editing of any device on the I<sup>2</sup>C bus. This editor works like the Register Map Editor, except that the I<sup>2</sup>C slave address must be entered and the Read All button is disabled.

To open this, click on Edit Register Map in the Edit menu and then click on Generic I<sup>2</sup>C.

The Generic I<sup>2</sup>C Editor can be used to communicate with other devices that can be connected to TVP5151EVM I<sup>2</sup>C bus.

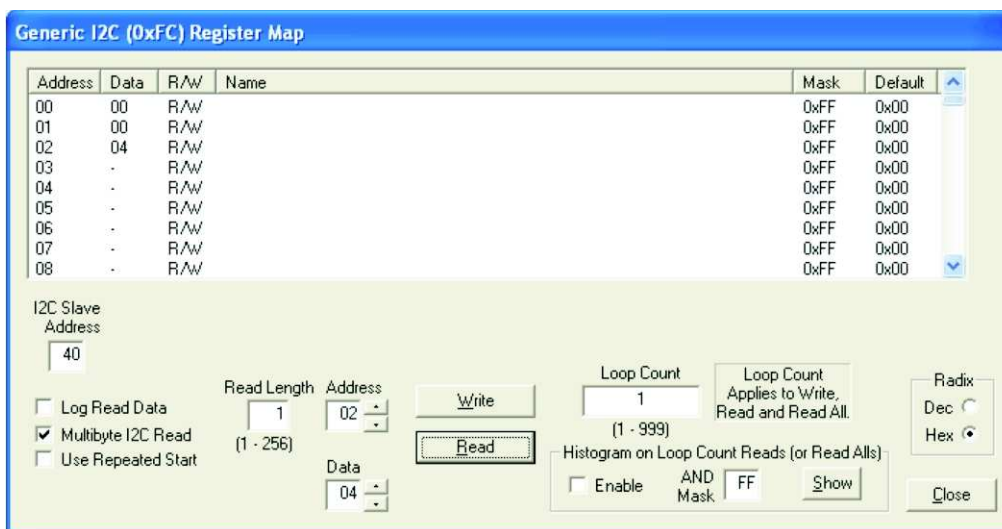

**Figure 17. Generic I2C Register Map Editor**

## 5.10 Property Sheets

The property sheets represent the register data in a user-friendly format. The data is organized by function, with each function having its own page and being selectable via tabs at the top (see [Figure 18](#)).

To open this, click on Edit Property Sheets in the Edit menu and select the device type to edit.

When the property sheet function is started, or whenever you tab to a different page, all readable registers in the device are read from hardware to initialize the dialog pages. Values on the page are changed by manipulating the various dialog controls as described in [Table 5](#).

There are OK, Cancel, and Apply buttons at the bottom of each property page. These are explained in [Table 6](#).

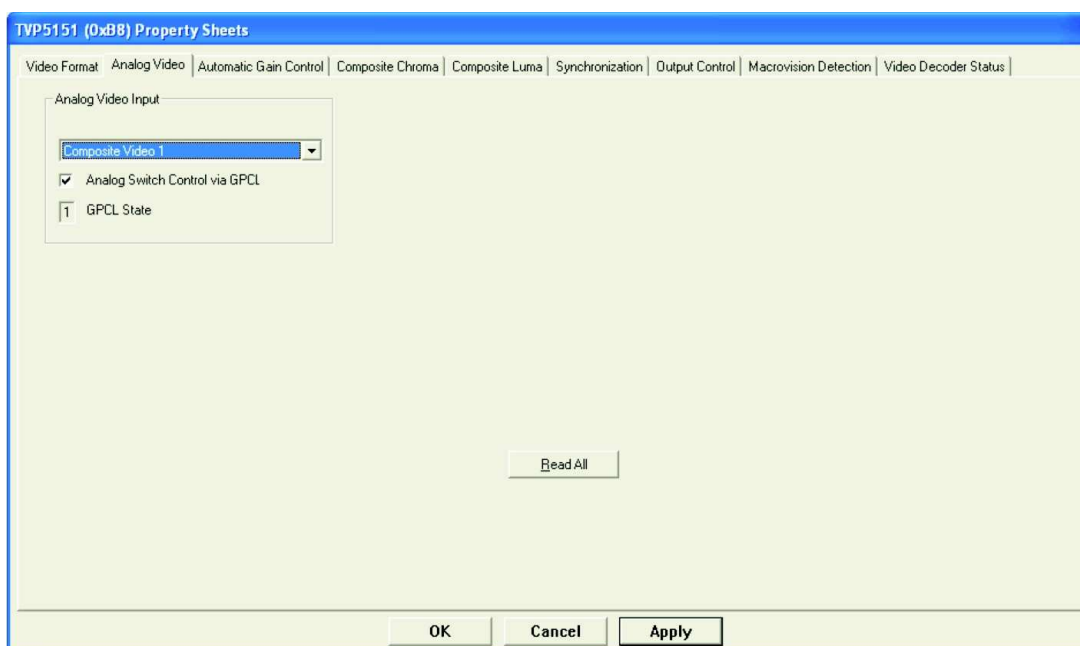

**Figure 18. TVP5151 Analog Video Property Sheet**

**Table 5. Use of Property Sheet Controls**

Dialog Control	What Do I Do With It?	When is Hardware Updated?
Read-only edit box	Read status information	N/A
Check box	Toggle a single bit	After Apply
Dropdown list	Select from a text list	After Apply
Edit box	Type a number	After Apply
Edit box with up/down arrows	Use up/down arrows or type a number	Up/Down arrows: Immediately Type a number: After Apply
Slider	Slide a lever	Immediately
Push button	Initiate an action	Immediately

**Table 6. Property Sheet Button Controls**

Button Control	Definition
OK	Writes to all writeable registers whose data has changed. A register is flagged as changed if the value to be written is different from the value last read from that address. Closes the dialog.
Cancel	Causes all changes made to the property page since the last Apply to be discarded. Changes made to dialog controls with immediate hardware update are not discarded, since they have already been changed in hardware. Does not write to hardware. Closes the dialog.
Apply	Writes to all writeable registers whose data has changed. A register is flagged as changed if the value to be written is different from the value last read from that address.

To enable multi-standard auto switching, select multi-standard mode and uncheck the formats that you want to include (see [Figure 19](#)).

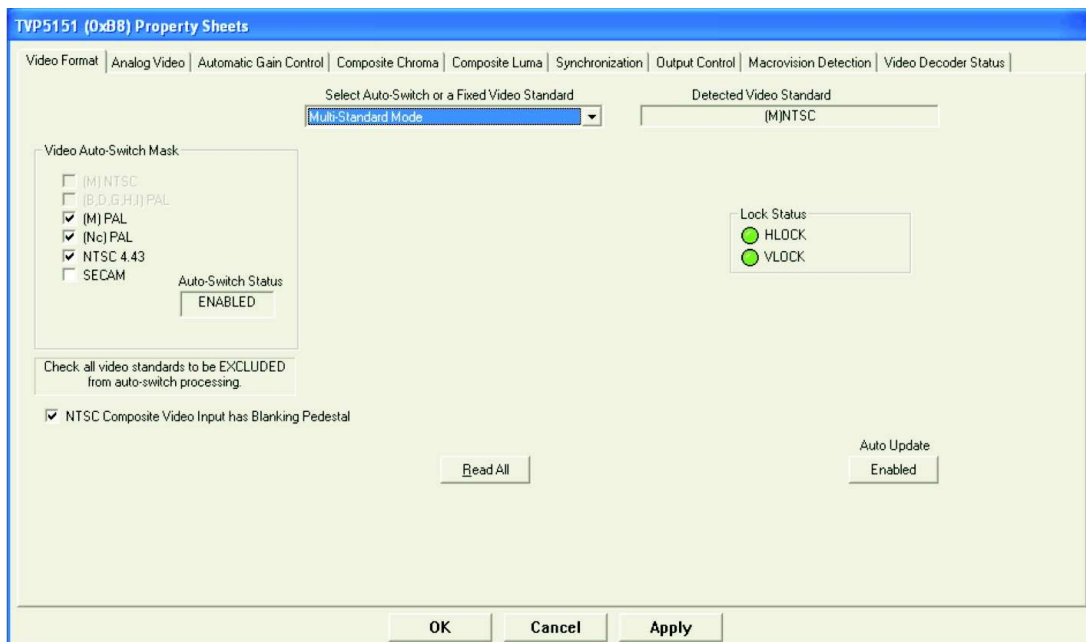

**Figure 19. TVP5151 Video Format Property Sheet**

Vertical lock, horizontal lock, color lock, and the detected video standard can all be observed with the TVP5151 Video Decoder Status Property Sheet (see [Figure 20](#)).

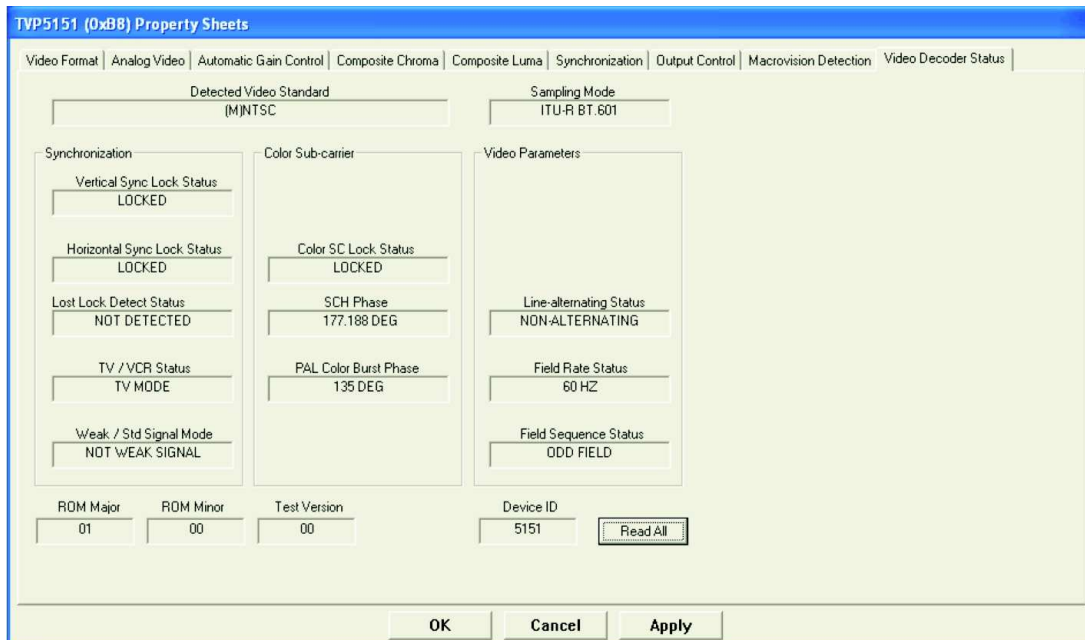

**Figure 20. TVP5151 Video Decoder Status Property Sheet**

The THS8200 Input Controls Property Sheet can be used to check the output format being received from the TVP5151 (see [Figure 21](#)). Pixel Count and Line Count are the total pixels per line and total lines per frame received from the TVP5151. Clicking on the RESET button followed by Read All ensures a current Format Detection Status reading. The THS8200 Digital Input Format must be left set to ITU-R BT.656 and the Timing Source must be left set to Embedded for proper operation.

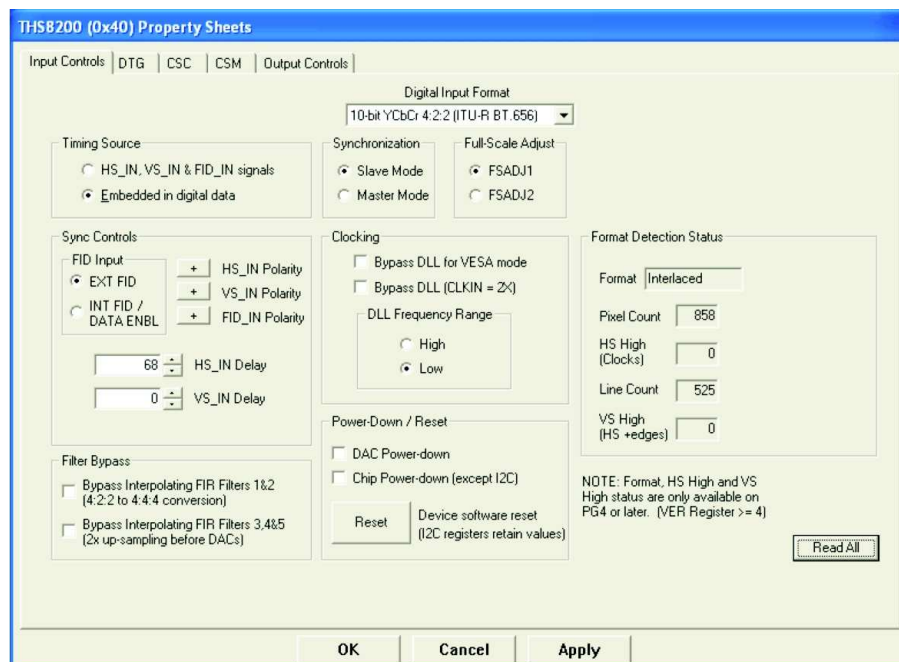

**Figure 21. THS8200 Input Controls Property Sheet**



### 5.10.1 Property Sheet Refresh

The TVP5151 property sheets were designed so that the data displayed is always current. Certain actions cause the entire register map to be read from the device and to update the property sheets. This happens when:

- Property sheets are initially opened.
- When tabbing from one page to another.
- When Read All is clicked.
- When making the Property Sheets window the active window (by clicking on it).
- When making a register map editor window the active window.

### 5.10.2 Auto-Update When Activating Windows

When you open both the property sheets and the register map editor at the same time, changes made to the property sheets (and applied) are updated in the register map window as soon as the register map window is clicked on. It also works the other way; changes made in the register map editor are updated in the property sheets as soon as the property sheets window is clicked on.

### 5.10.3 Property Page Auto Update

When the video decoder Video Format page is showing and the property sheets window is the active window and the Auto Update button on that page is enabled (default), the TVP5151 register map is read continuously and the status controls on that page are continuously updated.

## 6 Troubleshooting the TVP5151EVM

This section discusses ways to troubleshoot the TVP5151EVM.

### 6.1 Troubleshooting Guide

If you are experiencing problems with the TVP5151EVM hardware or the VCC6 software, see [Table 7](#) for available solutions.

**Table 7. Troubleshooting Guide**

Symptom	Cause	Solution
Blank screen	Wrong video input is selected.	Go to Edit>Property Sheets>TVP5151, input selection/AGC page, select the correct video input(s), and click Apply. (CH1 is selected by default.)
	Source is connected to the wrong input connector.	Connect source to the correct input connector.
	YCbCr outputs or clock output is disabled.	Go to Edit>Property Sheets>TVP5151, output page, check enable YCbCr outputs and enable clock outputs, and click Apply.
	Component output cable improperly connected to the monitor	Check cable with direct video connection to the monitor.
	The monitor being used does not support the video format being used.	Verify cables and monitor operation by connecting the signal source directly to the display.
	Auto-switch not functioning	See Auto-switch issues below.
	Damaged RCA connector or PCB trace	Check signal traces to and from RCA connectors for damage.
No color	Incorrect video format selected.	See Auto-switch issues below.
	Color burst input issue	Check composite signal input levels.
Screen colors are only magenta and green.	Wrong YCbCr output format.	Go to Edit>Property Sheets>TVP5151, output page, set the YCbCr output format to 8-bit 4:2:2 YCbCr w/ITU-R BT.656 embedded sync mode and click Apply. Check THS8200 Input Format setting.
Video standard auto-switch does not work on the video decoder side.	Auto-switch masks are not set correctly.	Go to Edit>Property Sheets>TVP5151, mode selection, uncheck all standards to be included in auto-switch processing, and click Apply.
	Video decoder is not in auto-switch mode.	Go to Edit>Property Sheets>TVP5151, mode selection page, set the drop-down box to multi-standard and click Apply.
Video standard auto-switch does not work on the video encoder side.	Auto-switch polling is not enabled.	Click real-time polling in the Tools menu. Click Enable All and OK.
USB: I <sup>2</sup> C error code 1	TVP5151 I <sup>2</sup> C slave address is wrong.	Make sure the TVP5151 I <sup>2</sup> C slave address selected at start-up is correct.
	THS8200 I <sup>2</sup> C slave address is wrong.	Make sure the THS8200 I <sup>2</sup> C slave address selected at start-up is correct.
	USB cable is not connected from TVP5151EVM to the host PC.	Connect cable and make sure the USB Link LED indicator is lit.
	EVM has been modified for use with a separate 5V power supply that is not connected.	Make sure that the 5V LED indicator is lit indicating the presence of 5V power.
	TVP5151 was placed in power-down mode.	Place J7 jumper in Normal position.
	EVM was configured for an external I <sup>2</sup> C master.	Reinstall 0-Ω resistors R131 and R132.
USB: Device not found	J9 jumper not installed. USB cable is not connected.	Install jumper and disconnect/reconnect USB cable. USB Link LED should be on.
USB: Invalid response code receive from device	Multiple instances of VCC are running.	Close all but one VCC instance.
Erratic or inconsistent I <sup>2</sup> C register read back.	Multiple instances of VCC are running.	Close all but one VCC instance.
Can't exit VCC	USB cable has been removed.	Attach USB cable and exit or use the Windows Task Manager to end VCC.
YPbPr output levels are distorted and too high.	Improper video termination at the oscilloscope.	Install 75-Ω termination resistor at the oscilloscope input.
No red or blue color displayed	Bad cable or damaged RCA connector	Check cable with direct connect to the monitor
	Broken PCB trace	Check signal path and traces connecting to the YPbPr connector.

## 6.2 Resolving I<sup>2</sup>C Communication Problems

When VCC is started, and the VCC Configuration dialog box is closed with OK, a USB I<sup>2</sup>C functionality test is performed. If the I<sup>2</sup>C system test fails, a dialog box like [Figure 22](#) appears. This figure reports that an I<sup>2</sup>C read from the TVP5151 failed, using slave address 0xBA, subaddress 0x00.

Similarly, a dialog box like [Figure 23](#) appears if there are I<sup>2</sup>C communication problems with the THS8200. If either of these dialog boxes appears, click on Exit Program. Restart VCC and ensure that the I<sup>2</sup>C addresses are set to the correct address. The hardware default addresses are 0xB8 and 0x40 for the TVP5151 and THS8200, respectively.



**Figure 22. TVP5151 I<sup>2</sup>C Error Report**



**Figure 23. THS8200 I<sup>2</sup>C Error Report**

If a dialog box similar to [Figure 24](#) appears, check the USB cable connection and the USB Link LED on the TVP5151EVM. The USB Link LED is lit if a valid USB link is established. Press the Continue button after the USB link is established.



**Figure 24. USB Link Error**

# 7 TVP5151EVM Schematics

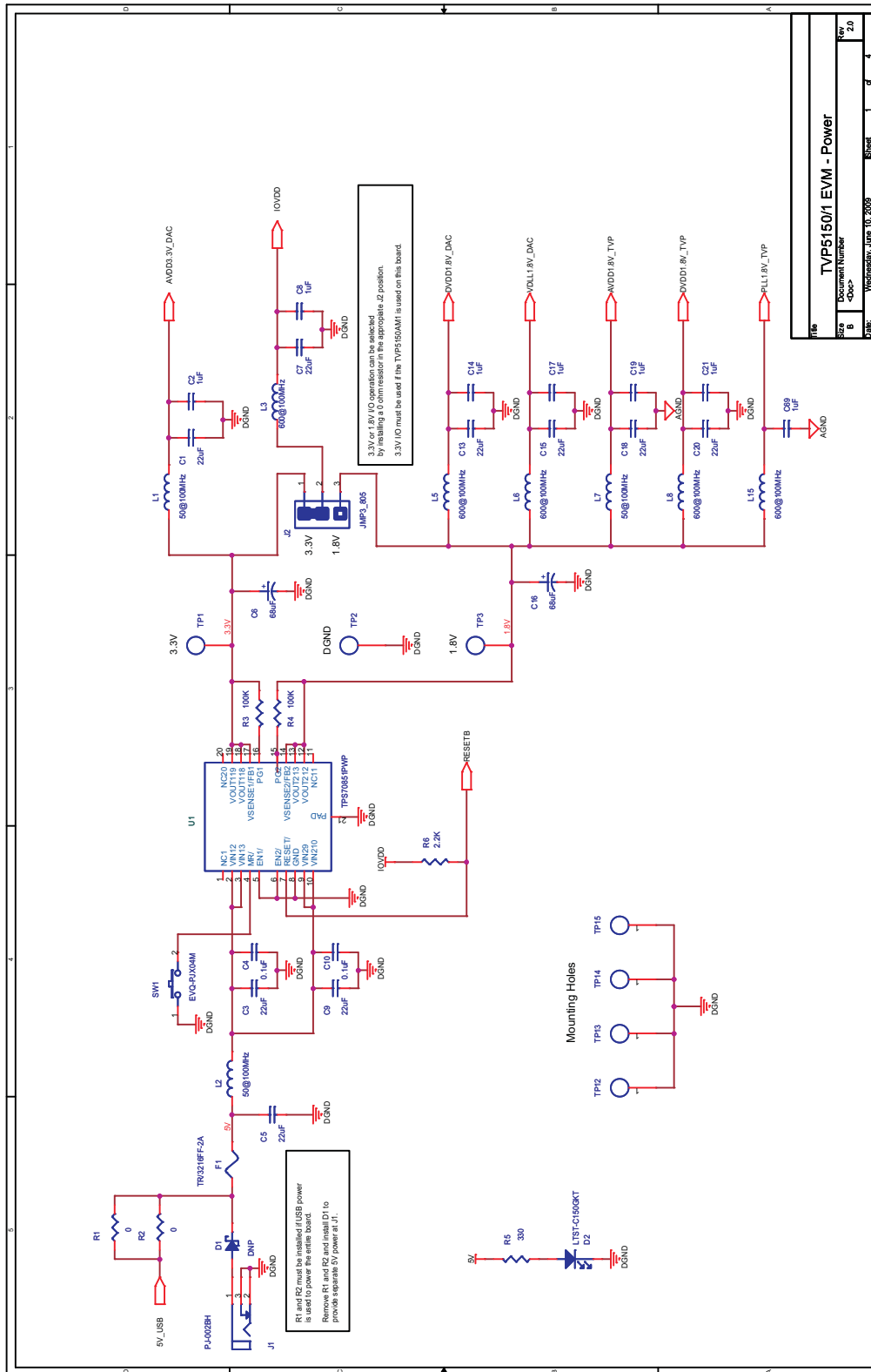

**Figure 25. Schematic - Power**

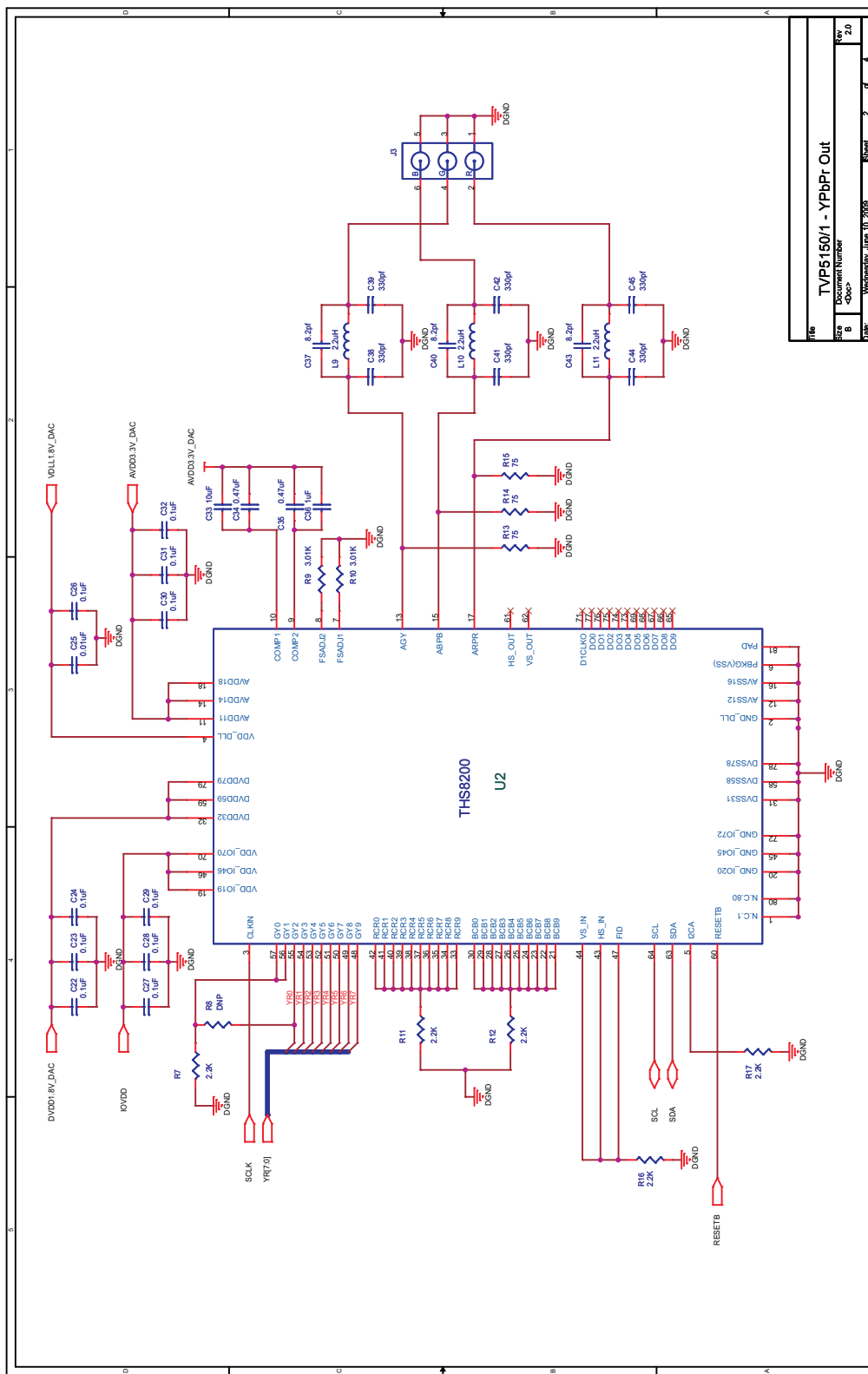
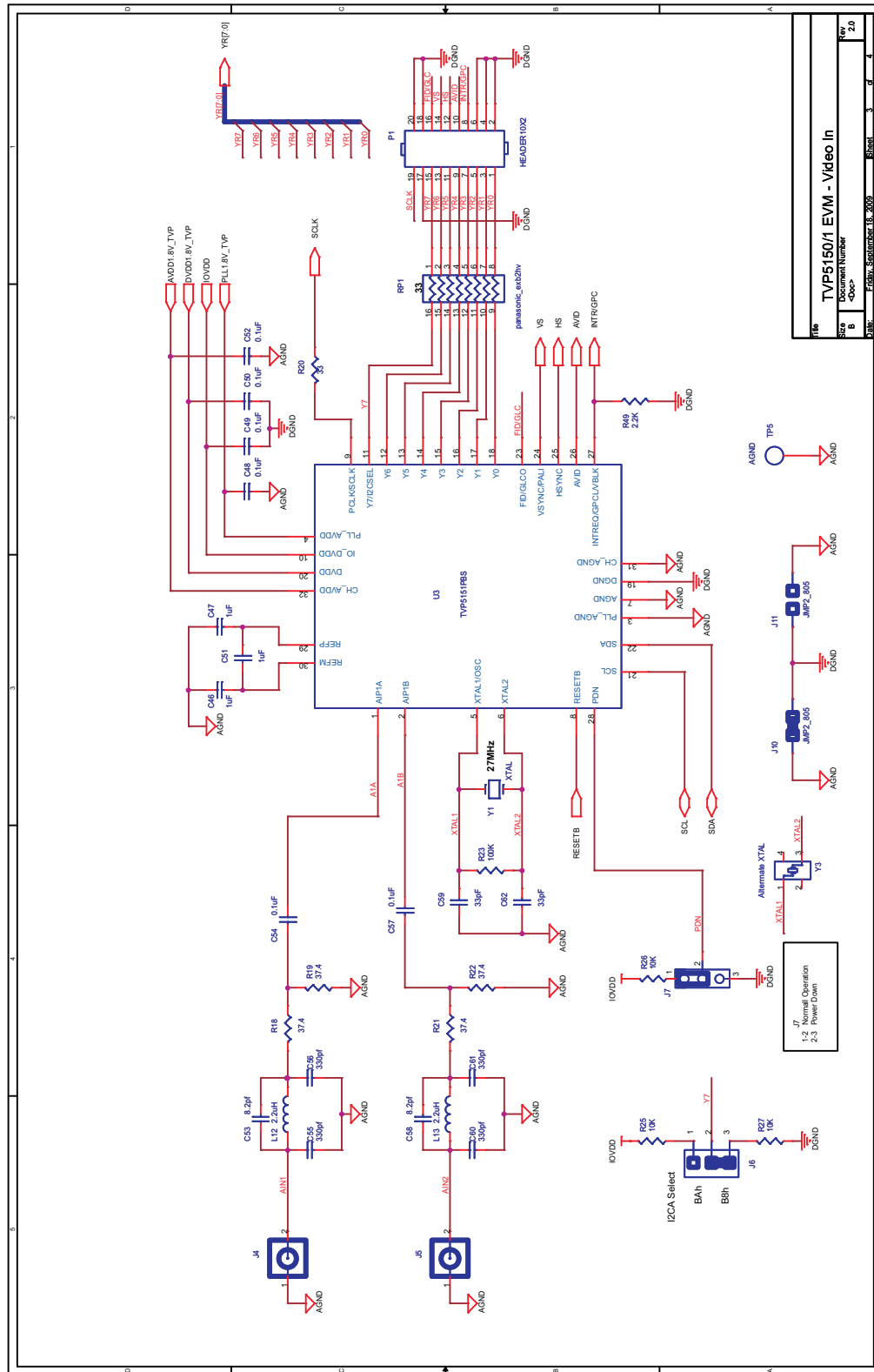
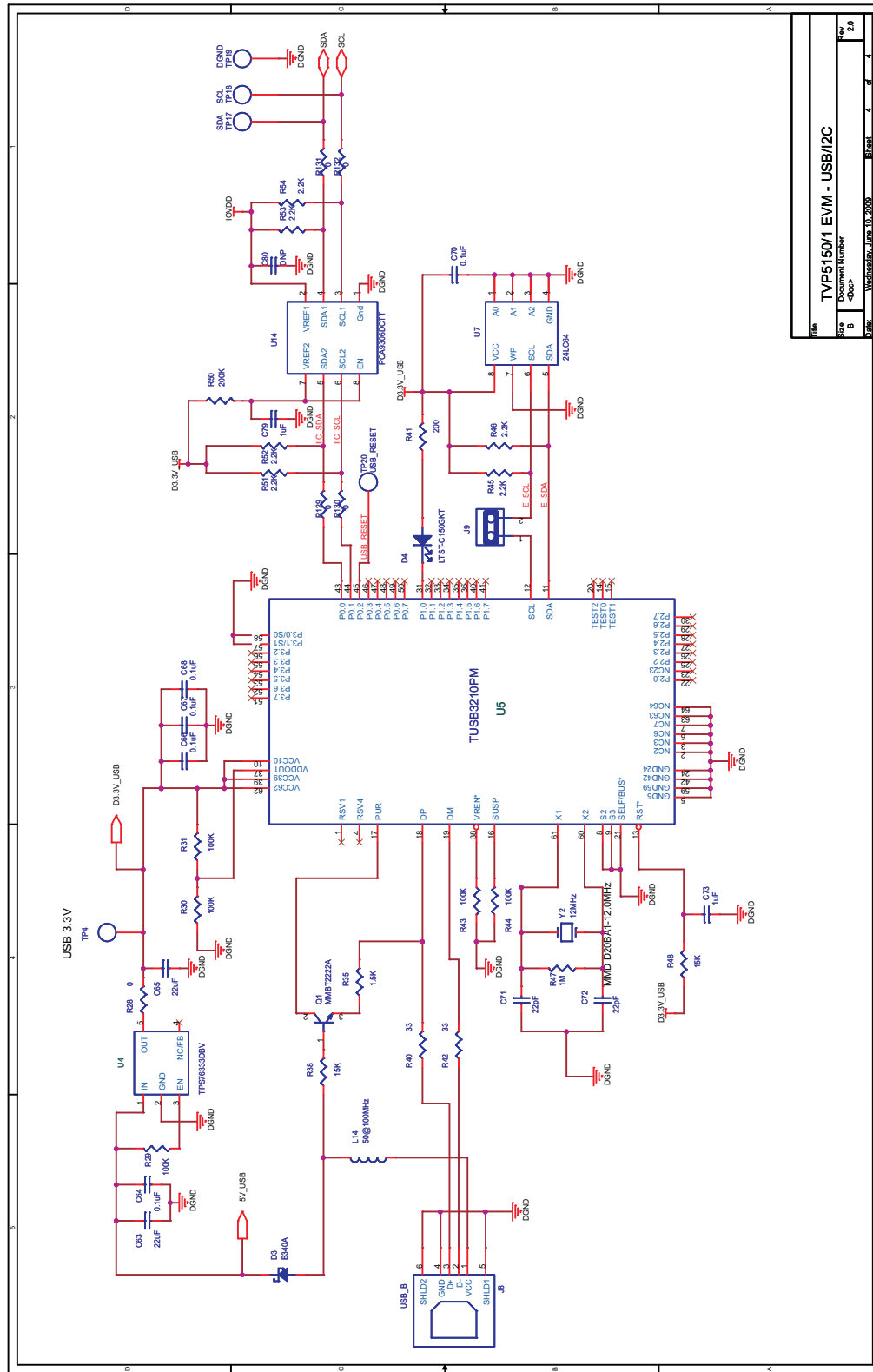

Figure 26. Schematic - YPbPr Out



**Figure 27. Schematic - Video In**



File	TVP5150/1 EVM - USB/I2C		
Size	Document Number	Rev	2.0
B	<Doc>		
Path	Workspace\jira_10_2009	Sheet	3 of 3

Figure 28. Schematic - USB/I<sup>2</sup>C

## IMPORTANT NOTICE

Texas Instruments Incorporated and its subsidiaries (TI) reserve the right to make corrections, modifications, enhancements, improvements, and other changes to its products and services at any time and to discontinue any product or service without notice. Customers should obtain the latest relevant information before placing orders and should verify that such information is current and complete. All products are sold subject to TI's terms and conditions of sale supplied at the time of order acknowledgment.

TI warrants performance of its hardware products to the specifications applicable at the time of sale in accordance with TI's standard warranty. Testing and other quality control techniques are used to the extent TI deems necessary to support this warranty. Except where mandated by government requirements, testing of all parameters of each product is not necessarily performed.

TI assumes no liability for applications assistance or customer product design. Customers are responsible for their products and applications using TI components. To minimize the risks associated with customer products and applications, customers should provide adequate design and operating safeguards.

TI does not warrant or represent that any license, either express or implied, is granted under any TI patent right, copyright, mask work right, or other TI intellectual property right relating to any combination, machine, or process in which TI products or services are used. Information published by TI regarding third-party products or services does not constitute a license from TI to use such products or services or a warranty or endorsement thereof. Use of such information may require a license from a third party under the patents or other intellectual property of the third party, or a license from TI under the patents or other intellectual property of TI.

Reproduction of TI information in TI data books or data sheets is permissible only if reproduction is without alteration and is accompanied by all associated warranties, conditions, limitations, and notices. Reproduction of this information with alteration is an unfair and deceptive business practice. TI is not responsible or liable for such altered documentation. Information of third parties may be subject to additional restrictions.

Resale of TI products or services with statements different from or beyond the parameters stated by TI for that product or service voids all express and any implied warranties for the associated TI product or service and is an unfair and deceptive business practice. TI is not responsible or liable for any such statements.

TI products are not authorized for use in safety-critical applications (such as life support) where a failure of the TI product would reasonably be expected to cause severe personal injury or death, unless officers of the parties have executed an agreement specifically governing such use. Buyers represent that they have all necessary expertise in the safety and regulatory ramifications of their applications, and acknowledge and agree that they are solely responsible for all legal, regulatory and safety-related requirements concerning their products and any use of TI products in such safety-critical applications, notwithstanding any applications-related information or support that may be provided by TI. Further, Buyers must fully indemnify TI and its representatives against any damages arising out of the use of TI products in such safety-critical applications.

TI products are neither designed nor intended for use in military/aerospace applications or environments unless the TI products are specifically designated by TI as military-grade or "enhanced plastic." Only products designated by TI as military-grade meet military specifications. Buyers acknowledge and agree that any such use of TI products which TI has not designated as military-grade is solely at the Buyer's risk, and that they are solely responsible for compliance with all legal and regulatory requirements in connection with such use.

TI products are neither designed nor intended for use in automotive applications or environments unless the specific TI products are designated by TI as compliant with ISO/TS 16949 requirements. Buyers acknowledge and agree that, if they use any non-designated products in automotive applications, TI will not be responsible for any failure to meet such requirements.

Following are URLs where you can obtain information on other Texas Instruments products and application solutions:

### Products

Amplifiers	<a href="http://amplifier.ti.com">amplifier.ti.com</a>
Data Converters	<a href="http://dataconverter.ti.com">dataconverter.ti.com</a>
DLP® Products	<a href="http://www.dlp.com">www.dlp.com</a>
DSP	<a href="http://dsp.ti.com">dsp.ti.com</a>
Clocks and Timers	<a href="http://www.ti.com/clocks">www.ti.com/clocks</a>
Interface	<a href="http://interface.ti.com">interface.ti.com</a>
Logic	<a href="http://logic.ti.com">logic.ti.com</a>
Power Mgmt	<a href="http://power.ti.com">power.ti.com</a>
Microcontrollers	<a href="http://microcontroller.ti.com">microcontroller.ti.com</a>
RFID	<a href="http://www.ti-rfid.com">www.ti-rfid.com</a>
RF/IF and ZigBee® Solutions	<a href="http://www.ti.com/lprf">www.ti.com/lprf</a>

### Applications

Audio	<a href="http://www.ti.com/audio">www.ti.com/audio</a>
Automotive	<a href="http://www.ti.com/automotive">www.ti.com/automotive</a>
Broadband	<a href="http://www.ti.com/broadband">www.ti.com/broadband</a>
Digital Control	<a href="http://www.ti.com/digitalcontrol">www.ti.com/digitalcontrol</a>
Medical	<a href="http://www.ti.com/medical">www.ti.com/medical</a>
Military	<a href="http://www.ti.com/military">www.ti.com/military</a>
Optical Networking	<a href="http://www.ti.com/opticalnetwork">www.ti.com/opticalnetwork</a>
Security	<a href="http://www.ti.com/security">www.ti.com/security</a>
Telephony	<a href="http://www.ti.com/telephony">www.ti.com/telephony</a>
Video & Imaging	<a href="http://www.ti.com/video">www.ti.com/video</a>
Wireless	<a href="http://www.ti.com/wireless">www.ti.com/wireless</a>

Mailing Address: Texas Instruments, Post Office Box 655303, Dallas, Texas 75265  
Copyright © 2009, Texas Instruments Incorporated