

# TPS54627 Step-Down Converter Evaluation Module User's Guide



## ABSTRACT

This user's guide contains information for the TPS54627EVM-052 evaluation module (EVM) as well as for the TPS54627. Included are the performance specifications, schematic, and the bill of materials of the TPS54627EVM-052.

## Table of Contents

<b>1 Introduction</b> .....	3
<b>2 Performance Specification Summary</b> .....	4
<b>3 Modifications</b> .....	5
3.1 Output Voltage Setpoint.....	5
3.2 Output Filter and Closed-Loop Response.....	5
<b>4 Test Setup and Results</b> .....	6
4.1 Input/Output Connections.....	6
4.2 Start-Up Procedure.....	6
4.3 Efficiency.....	7
4.4 Load Regulation.....	8
4.5 Line Regulation.....	8
4.6 Load Transient Response.....	9
4.7 Output Voltage Ripple.....	9
4.8 Input Voltage Ripple.....	10
4.9 Start-Up.....	11
4.10 Shut-Down.....	12
<b>5 Board Layout</b> .....	13
5.1 Layout.....	13
<b>6 Schematic, Bill of Materials, and Reference</b> .....	16
6.1 Schematic.....	16
6.2 Bill of Materials.....	17
6.3 Reference.....	17
<b>7 Revision History</b> .....	17

## List of Figures

Figure 4-1. TPS54627EVM-052 Efficiency.....	7
Figure 4-2. TPS54627EVM-052 Light-Load Efficiency.....	7
Figure 4-3. TPS54627EVM-052 Load Regulation, $V_{IN} = 5\text{ V}$ and $V_{IN} = 12\text{ V}$ .....	8
Figure 4-4. TPS54627EVM-052 Line Regulation.....	8
Figure 4-5. TPS54627EVM-052 Load Transient Response.....	9
Figure 4-6. TPS54627EVM-052 Output Voltage Ripple ( $I_{OUT} = 2\text{ A}$ ).....	9
Figure 4-7. TPS54627EVM-052 Output Voltage Ripple ( $I_{OUT} = 100\text{ mA}$ ).....	10
Figure 4-8. TPS54627EVM-052 Input Voltage Ripple.....	10
Figure 4-9. TPS54627EVM-052 Start-Up Relative to $V_{IN}$ with SS.....	11
Figure 4-10. TPS54627EVM-052 Start-Up Relative to EN with SS.....	11
Figure 4-11. TPS54627EVM-052 Shut-Down Relative to $V_{IN}$ with SS.....	12
Figure 4-12. TPS54627EVM-052 Shut-Down Relative to EN with SS.....	12
Figure 5-1. Top Assembly.....	13
Figure 5-2. Top Layer.....	14
Figure 5-3. Internal Layer 1.....	14
Figure 5-4. Internal Layer 2.....	15
Figure 5-5. Bottom Layer.....	15

Figure 6-1. TPS54627EVM-052 Schematic Diagram.....	16
--	----

### List of Tables

Table 1-1. Input Voltage and Output Current Summary.....	3
Table 2-1. TPS54627EVM-052 Performance Specifications Summary.....	4
Table 3-1. Output Voltages.....	5
Table 4-1. Connection and Test Points.....	6
Table 6-1. Bill of Materials.....	17

### Trademarks

D-CAP2™ is a trademark of Texas Instruments.

All trademarks are the property of their respective owners.

## 1 Introduction

The TPS54627 is a single, adaptive on-time, D-CAP2™-mode, synchronous buck converter that requires a low external component count. The D-CAP2™ control circuit is optimized for low-ESR output capacitors such as POSCAP, SP-CAP, or ceramic types and features fast transient response with no external compensation. The switching frequency is internally set at a nominal 650 kHz. The high-side and low-side switching MOSFETs are incorporated inside the TPS54627 package along with the gate-drive circuitry. The low drain-to-source on-resistance of the MOSFETs allows the TPS54627 to achieve high efficiencies and helps keep the junction temperature low at high-output currents. The TPS54627 DC/DC synchronous converter is designed to provide up to a 6-A output from an input voltage source of 4.5 V to 18 V. The output voltage range is from 0.76 V to 5.5 V. Rated input voltage and output current range for the evaluation module are given in [Table 1-1](#).

The TPS54627EVM-052 evaluation module circuit is a single, synchronous buck converter providing 1.05 V at 6 A from 4.5-V to 18-V input. This user's guide describes the TPS54627EVM-052 performance.

**Table 1-1. Input Voltage and Output Current Summary**

EVM	INPUT VOLTAGE RANGE	OUTPUT CURRENT RANGE
TPS54627EVM-052	$V_{IN} = 4.5 \text{ V to } 18 \text{ V}$	0 A to 6 A

## 2 Performance Specification Summary

A summary of the TPS54627EVM-052 performance specifications is provided in [Table 2-1](#). Specifications are given for an input voltage of  $V_{IN} = 12\text{ V}$  and an output voltage of  $1.05\text{ V}$ , unless otherwise noted. The ambient temperature is  $25^{\circ}\text{C}$  for all measurement, unless otherwise noted.

**Table 2-1. TPS54627EVM-052 Performance Specifications Summary**

SPECIFICATIONS	TEST CONDITIONS	MIN	TYP	MAX	UNIT
Input voltage range ( $V_{IN}$ )		4.5	12	18	V
Output voltage			1.05		V
Operating frequency	$V_{IN} = 12\text{ V}$ , $I_O = 1\text{ A}$		650		kHz
Output current range		0		6	A
Line regulation	$I_O = 1\text{ A}$		$\pm 0.3$		%
Load regulation	$V_{IN} = 12\text{ V}$		$\pm 0.15$		%
Overcurrent limit	$V_{IN} = 12\text{ V}$ , $L_O = 1.5\text{ }\mu\text{H}$	6.7	7.3	8.9	A
Output ripple voltage	$V_{IN} = 12\text{ V}$ , $I_O = 2\text{ A}$		20		mV <sub>PP</sub>
Maximum efficiency	$V_{IN} = 5\text{ V}$ , $I_O = 1.0\text{ A}$		91.3		%

### 3 Modifications

These evaluation modules are designed to provide access to the features of the TPS54627. Some modifications can be made to this module.

#### 3.1 Output Voltage Setpoint

To change the output voltage of the EVMs, it is necessary to change the value of resistor R1. Changing the value of R1 can change the output voltage above 0.765 V. The value of R1 for a specific output voltage can be calculated using [Equation 1](#).

For output voltage from 0.76 V to 5.5 V:

$$V_O = 0.765 \times \left( 1 + \frac{R_1}{R_2} \right) \quad (1)$$

[Table 3-1](#) lists the R1 values for some common output voltages. A feedforward capacitor (C4) may be used to improve phase margin. Feedforward capacitors are most effective for higher output voltages of 1.8 V or above. Pads for this component (C4) are provided on the printed-circuit board (PCB). Note that the resistor values given in [Table 3-1](#) are standard values and not the exact value calculated using [Equation 1](#).

**Table 3-1. Output Voltages**

OUTPUT VOLTAGE E (V)	R1 (kΩ)	R2 (kΩ)	C4 (pF) <sup>(1)</sup>			L1 (μH)			C9 + C10 +C11 (μF)	
			MIN	TYP	MAX	MIN	TYP	MAX	MIN	MAX
1	6.81	22.1	5	150	220	1.0	1.5	4.7	22	68
1.05	8.25	22.1	5	150	220	1.0	1.5	4.7	22	68
1.2	12.7	22.1	5		100	1.0	1.5	4.7	22	68
1.5	21.5	22.1	5		68	1.0	1.5	4.7	22	68
1.8	30.1	22.1	5		22	1.2	1.5	4.7	22	68
2.5	49.9	22.1	5		22	1.5	2.2	4.7	22	68
3.3	73.2	22.1	2		22	1.8	2.2	4.7	22	68
5	124	22.1	2		22	2.2	3.3	4.7	22	68

(1) Optional

#### 3.2 Output Filter and Closed-Loop Response

The TPS54627 relies on the output filter characteristics to ensure stability of the control loop. The recommended output filter components for common output voltages are given in [Table 3-1](#). It is possible for other output filter component values to provide acceptable closed-loop characteristics. R3 and TP4 are provided for convenience in breaking the control loop and measuring the closed-loop response.

## 4 Test Setup and Results

This section describes how to properly connect, set up, and use the TPS54627EVM-052. The section also includes test results typical for the evaluation modules and efficiency, output load regulation, output line regulation, load transient response, output voltage ripple, input voltage ripple, start-up, and switching frequency.

### 4.1 Input/Output Connections

The TPS54627EVM-052 is provided with input and output connectors and test points as shown in [Table 4-1](#). A power supply capable of supplying 3 A must be connected to J1 through a pair of 20-AWG wires. The load must be connected to J2 through a pair of 20-AWG wires. The maximum load current capability is 6 A. Wire lengths must be minimized to reduce losses in the wires. Test point TP1 provides a place to monitor the  $V_{IN}$  input voltages with TP2 providing a convenient ground reference. TP8 is used to monitor the output voltage with TP9 as the ground reference.

**Table 4-1. Connection and Test Points**

REFERENCE DESIGNATOR	FUNCTION
J1	$V_{IN}$ (see <a href="#">Table 1-1</a> for $V_{IN}$ range)
J2	$V_{OUT}$ , 1.05 V at 2-A maximum
JP1	EN control. Connect EN to OFF to disable, connect EN to ON to enable.
TP1	$V_{IN}$ test point at $V_{IN}$ connector
TP2	GND test point at $V_{IN}$ connector
TP3	EN test point
TP4	Loop response measurement test point
TP5	VREG5 test point
TP6	Switch node test point
TP7	Analog ground test point
TP8	Output voltage test point at $V_{OUT}$ connector
TP9	Ground test point at $V_{OUT}$ connector

### 4.2 Start-Up Procedure

1. Ensure that the jumper at JP1 (Enable control) is set from EN to OFF.
2. Apply appropriate  $V_{IN}$  voltage to  $V_{IN}$  and PGND terminals at J1.
3. Move the jumper at JP1 (Enable control) to cover EN and ON. The EVM enables the output voltage.

### 4.3 Efficiency

Figure 4-1 shows the efficiency for the TPS54627EVM-052 at an ambient temperature of 25°C.

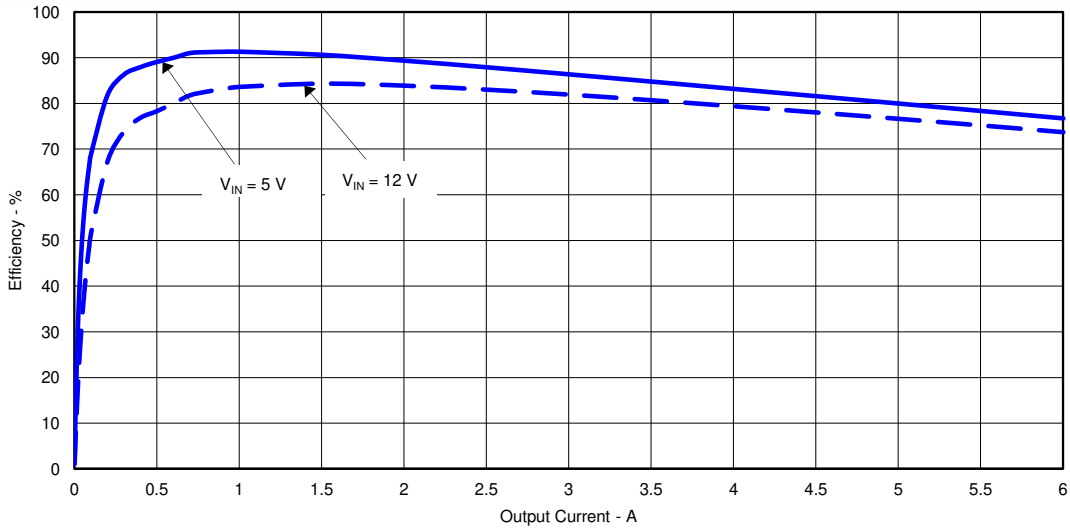

**Figure 4-1. TPS54627EVM-052 Efficiency**

Figure 4-2 shows the efficiency at light loads for the TPS54627EVM-052 at an ambient temperature of 25°C.

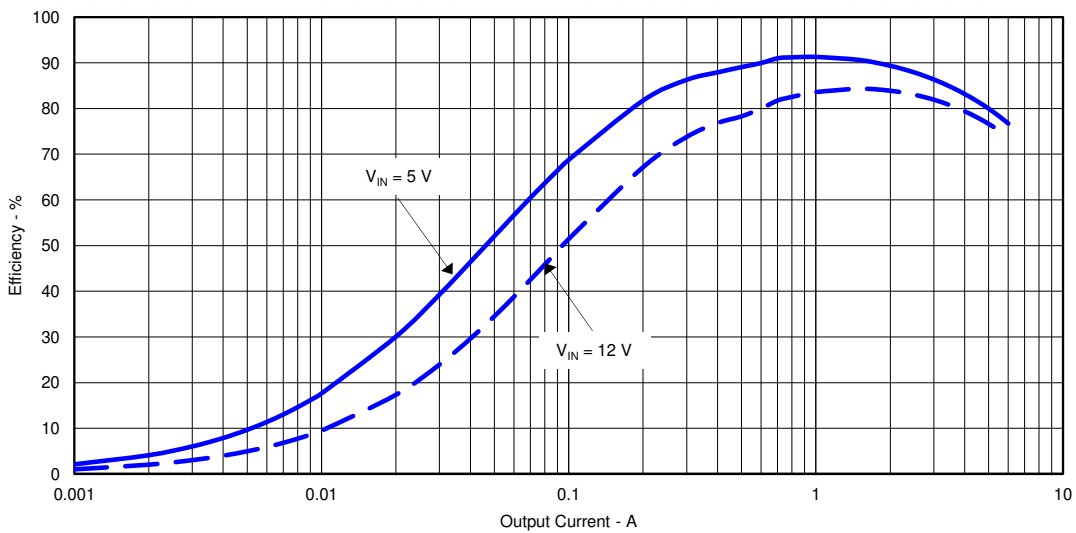

**Figure 4-2. TPS54627EVM-052 Light-Load Efficiency**

### 4.4 Load Regulation

The load regulation for the TPS54627EVM-052 is shown in Figure 4-3.

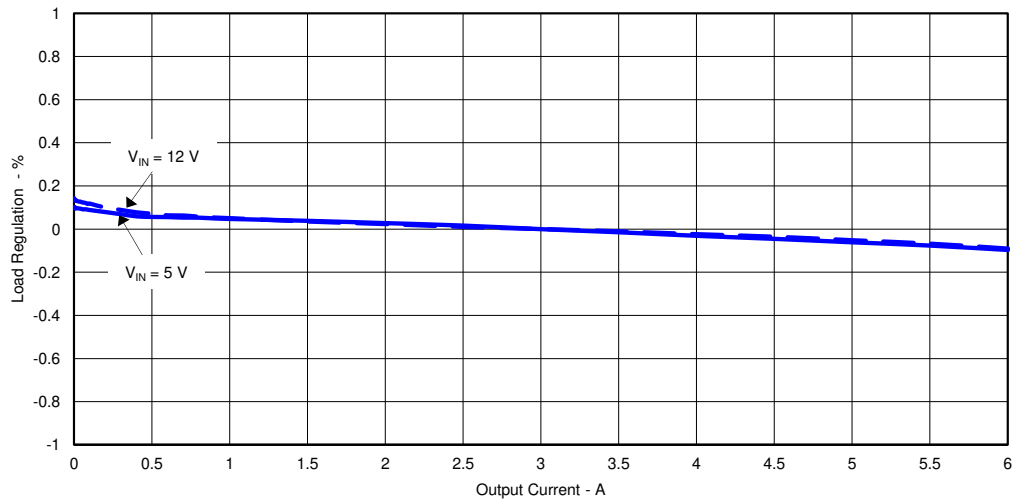

Figure 4-3. TPS54627EVM-052 Load Regulation,  $V_{IN} = 5\text{ V}$  and  $V_{IN} = 12\text{ V}$

### 4.5 Line Regulation

The line regulation for the TPS54627EVM-052 is shown in Figure 4-4.

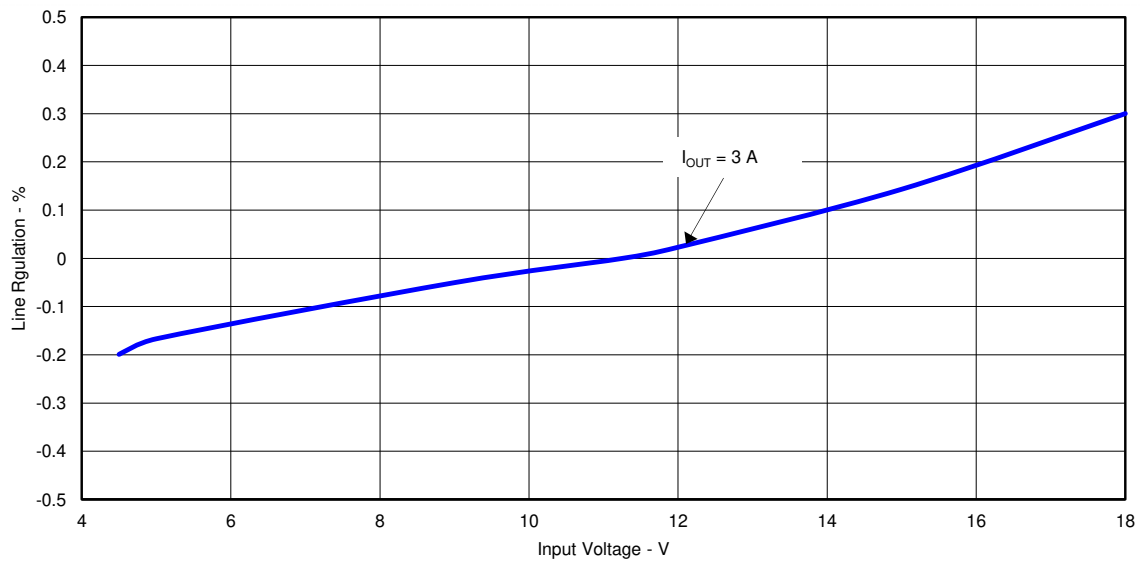

Figure 4-4. TPS54627EVM-052 Line Regulation



## 4.6 Load Transient Response

The TPS54627EVM-052 response to load transient is shown in Figure 4-5. The current step is from 1.5 A to 4.5 A. Total peak-to-peak voltage variation is as shown.

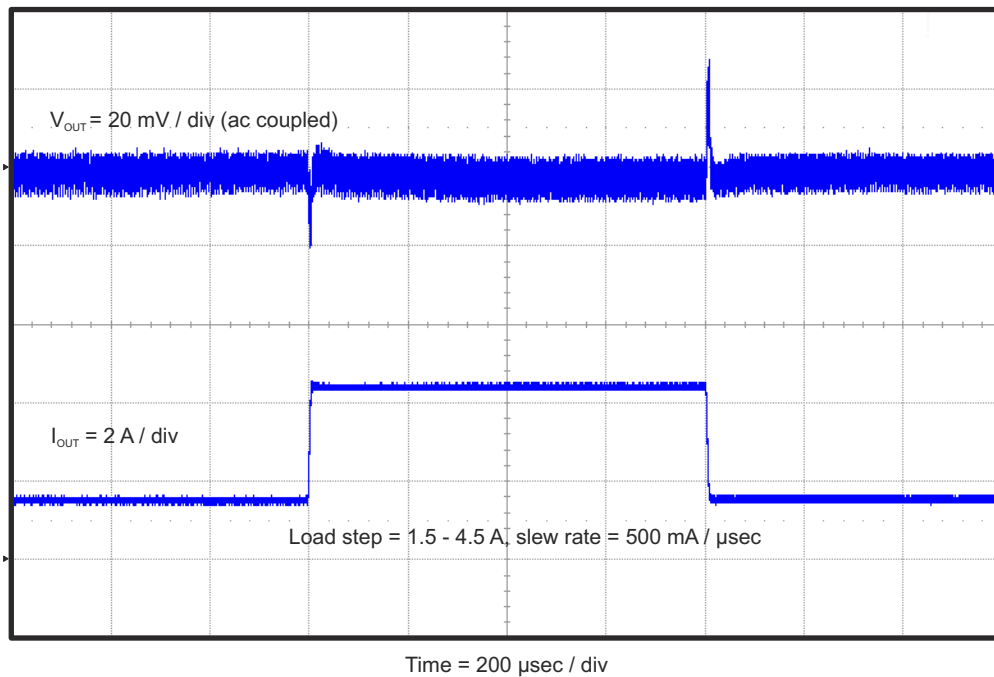

Figure 4-5. TPS54627EVM-052 Load Transient Response

## 4.7 Output Voltage Ripple

The TPS54627EVM-052 output voltage ripple is shown in Figure 4-6. The output current is the rated full load of 6 A.

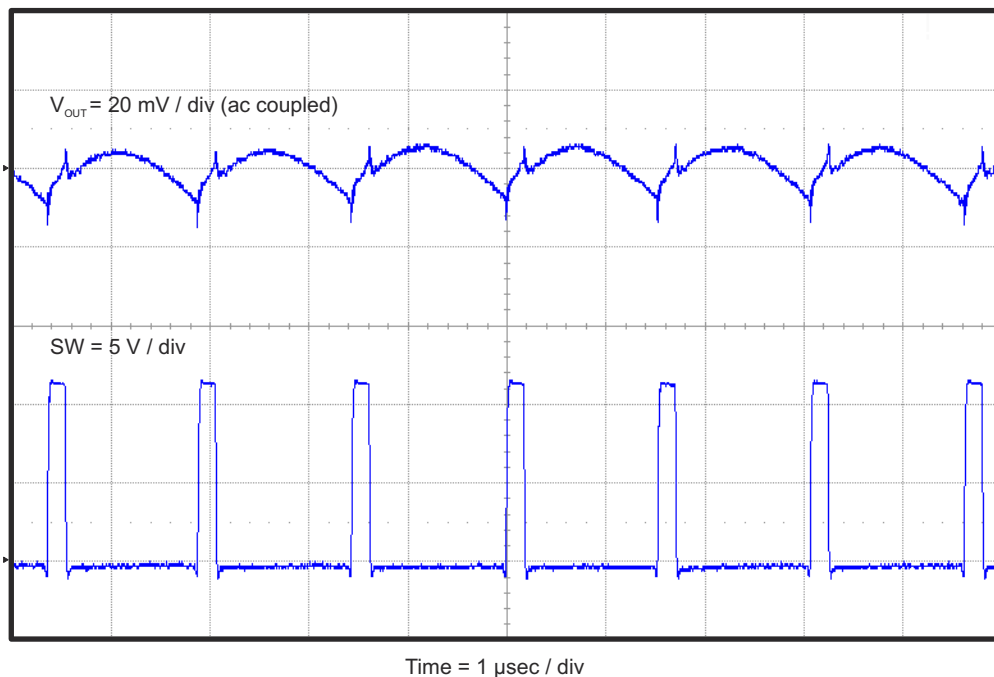
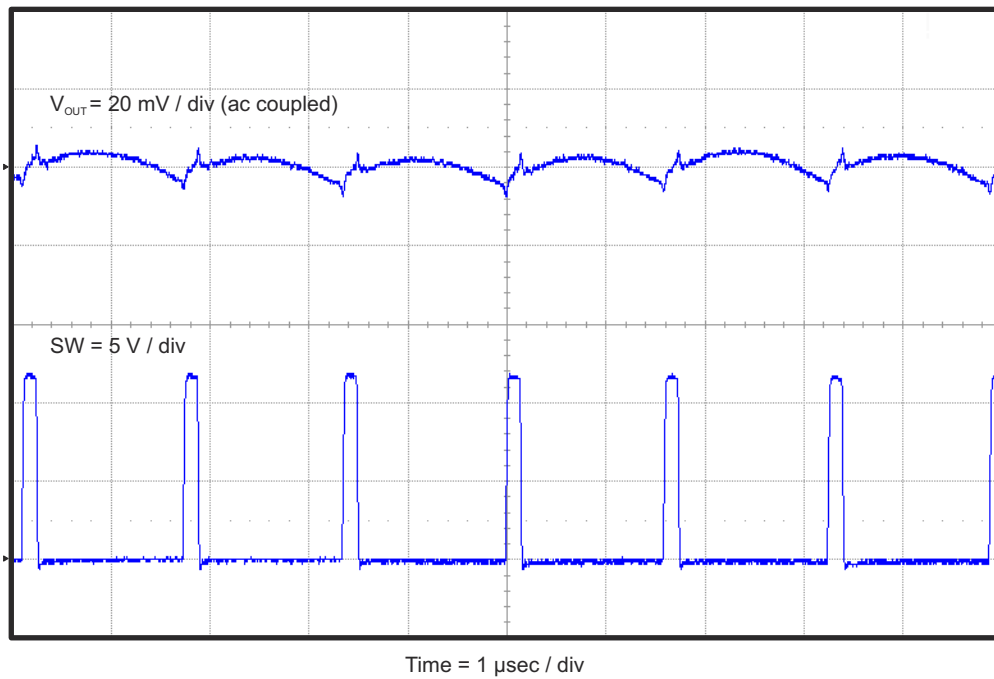

Figure 4-6. TPS54627EVM-052 Output Voltage Ripple ( $I_{OUT} = 2 \text{ A}$ )

The TPS54627EVM-052 output voltage ripple is shown in Figure 4-7. The output current is 100 mA.



**Figure 4-7. TPS54627EVM-052 Output Voltage Ripple ( $I_{OUT} = 100 \text{ mA}$ )**

#### 4.8 Input Voltage Ripple

The TPS54627EVM-052 input voltage ripple is shown in [Figure 4-8](#). The output current is the rated full load of 6 A.

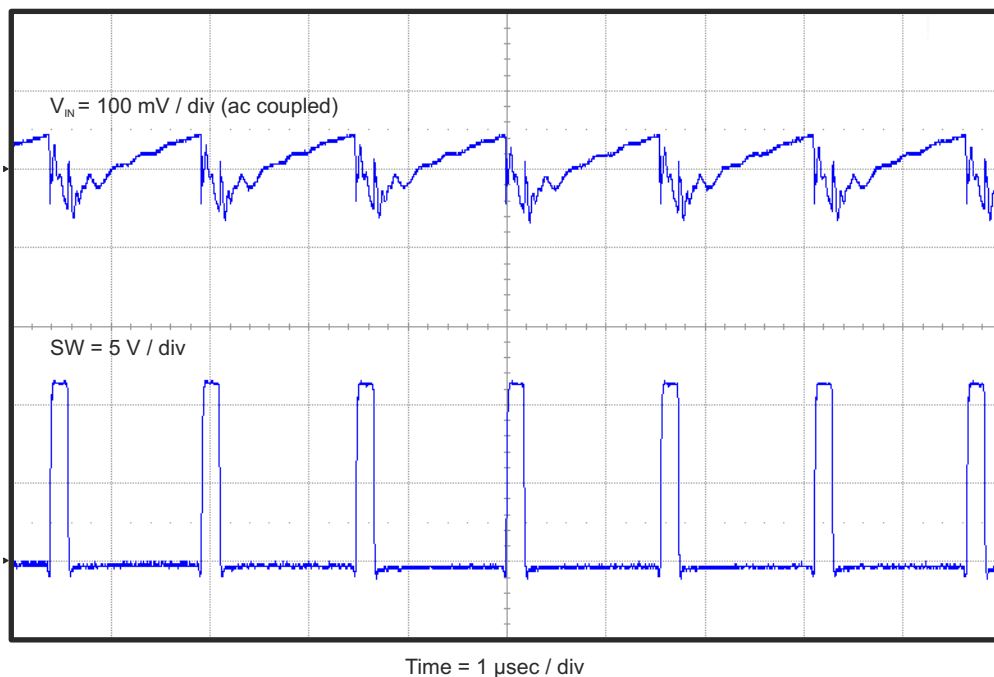

**Figure 4-8. TPS54627EVM-052 Input Voltage Ripple**

### 4.9 Start-Up

The TPS54627EVM-052 start-up waveforms relative to  $V_{IN}$  and EN are shown in Figure 4-9 and Figure 4-10.  $R_{LOAD} = 1 \Omega$ .

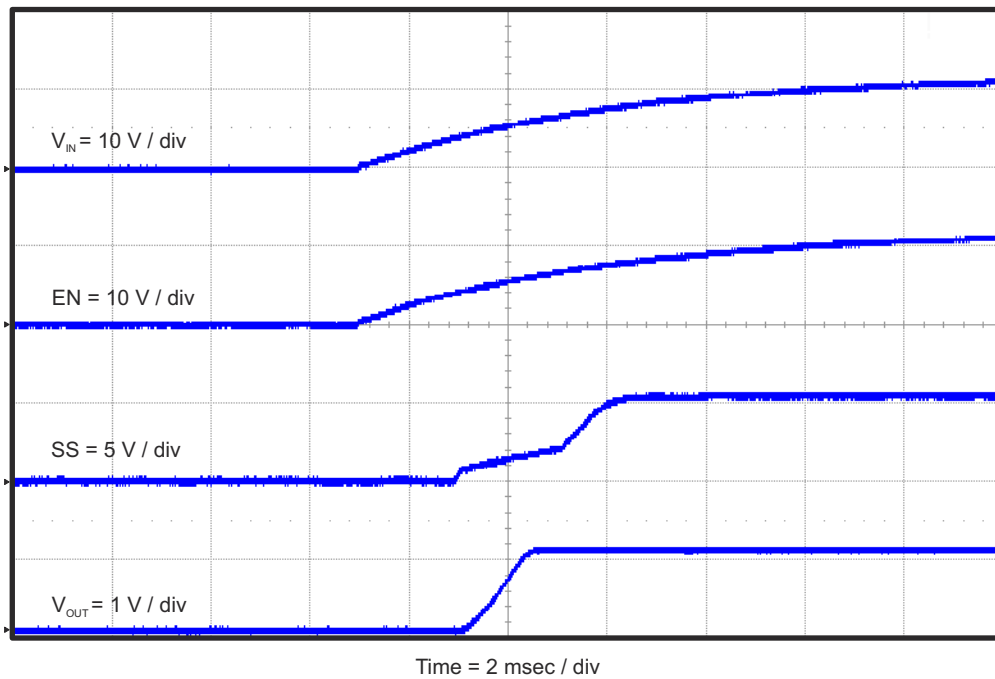

**Figure 4-9. TPS54627EVM-052 Start-Up Relative to  $V_{IN}$  with SS**

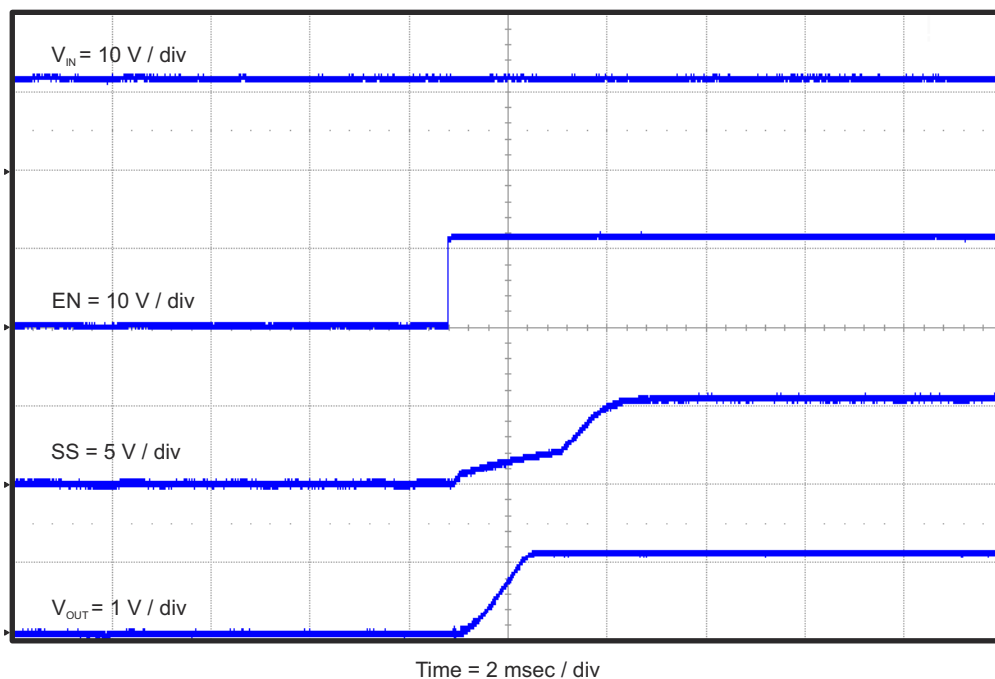

**Figure 4-10. TPS54627EVM-052 Start-Up Relative to EN with SS**

### 4.10 Shut-Down

The TPS54627EVM-052 shut-down waveforms relative to  $V_{IN}$  and EN are shown in Figure 4-11 and Figure 4-12.  $R_{LOAD} = 1 \Omega$ .

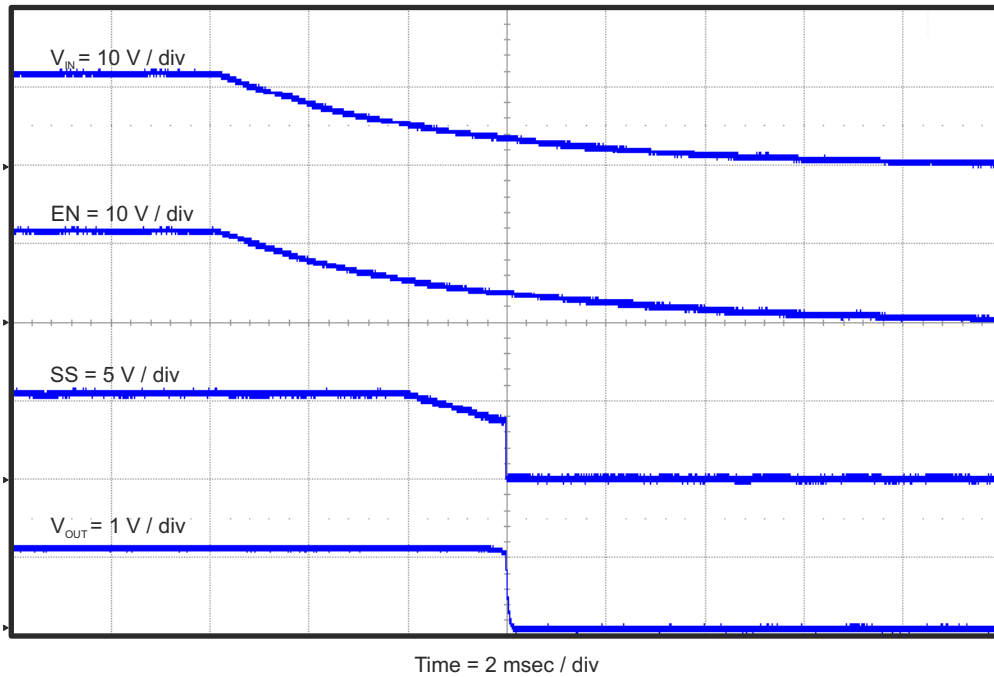

**Figure 4-11. TPS54627EVM-052 Shut-Down Relative to  $V_{IN}$  with SS**

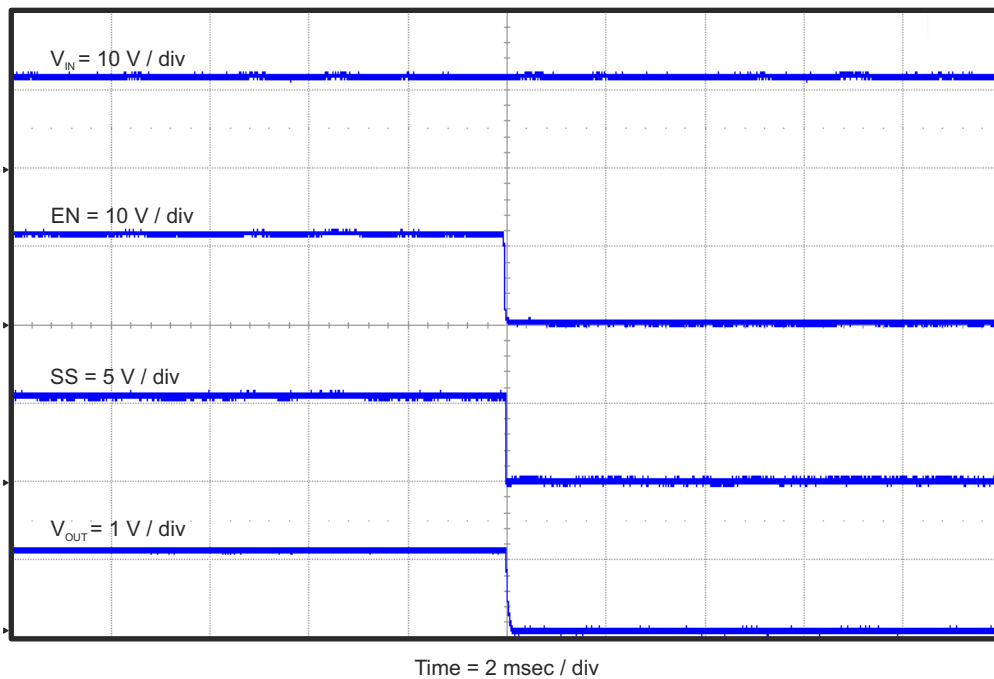

**Figure 4-12. TPS54627EVM-052 Shut-Down Relative to EN with SS**

## 5 Board Layout

This section provides description of the TPS54627EVM-052, board layout, and layer illustrations.

### 5.1 Layout

The board layout for the TPS54627EVM-052 is shown in [Figure 5-1](#) through [Figure 5-5](#). The top layer contains the main power traces for VIN, VOUT, and ground. Also on the top layer are connections for the pins of the TPS54628 and a large area filled with ground. Most of the signal traces also are located on the top side. The input decoupling capacitors are located as close to the IC as possible. The input and output connectors, test points, and all of the components are located on the top side. An analog ground (GND) area is provided on the top side. Analog ground (GND) and power ground (PGND) are connected at a single point on the top layer near C6. The two internal layers are completely dedicated to power ground planes. The bottom layer is primarily power ground. Traces also connect VIN to the enable control jumper, VREG5 test points and the feedback trace from VOUT to the voltage setpoint divider network.

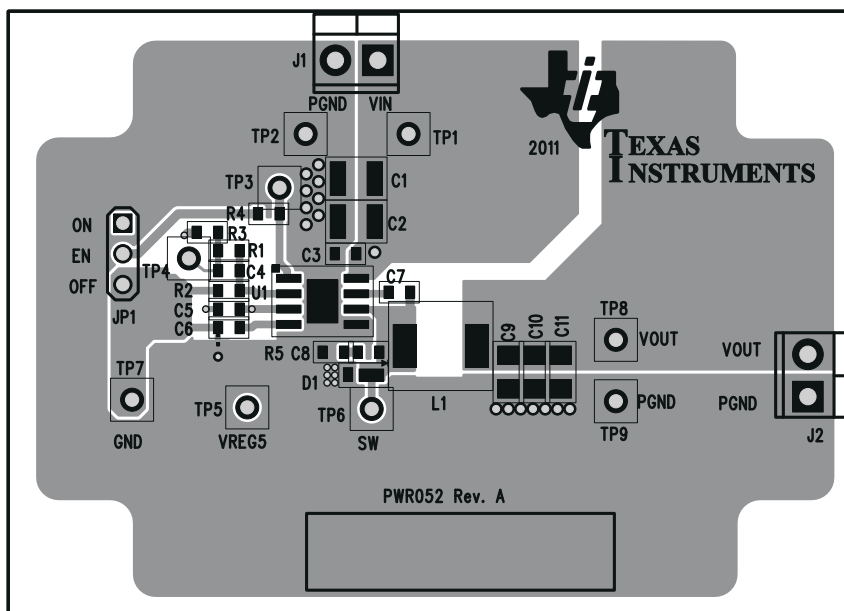
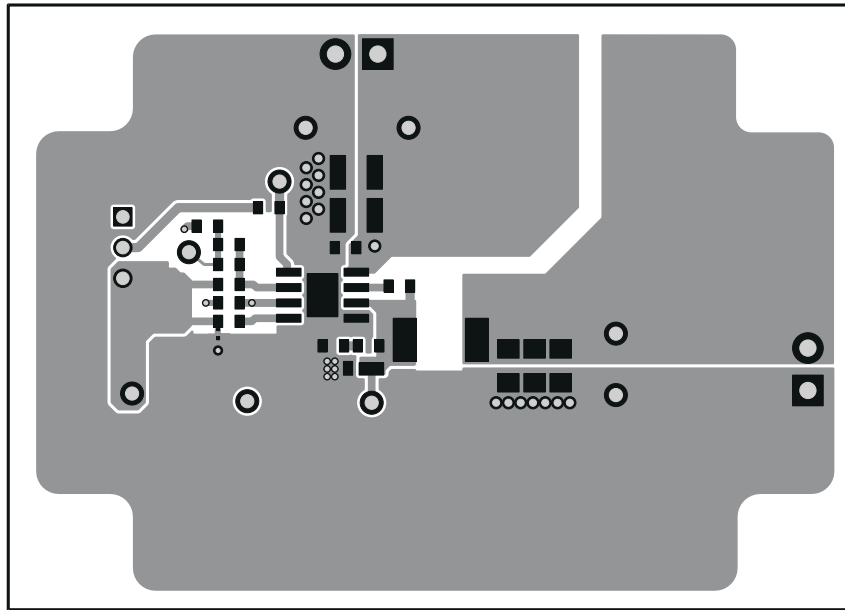
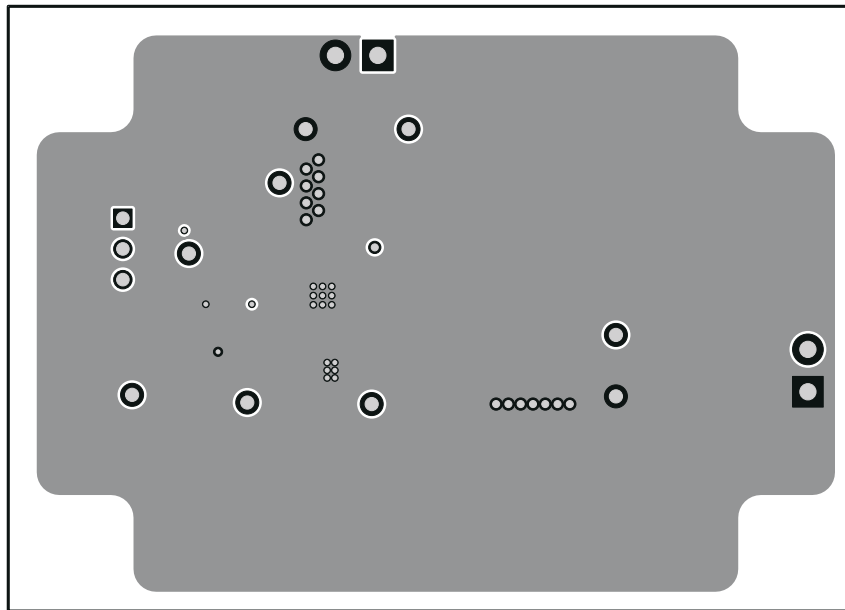

Figure 5-1. Top Assembly



**Figure 5-2. Top Layer**



**Figure 5-3. Internal Layer 1**

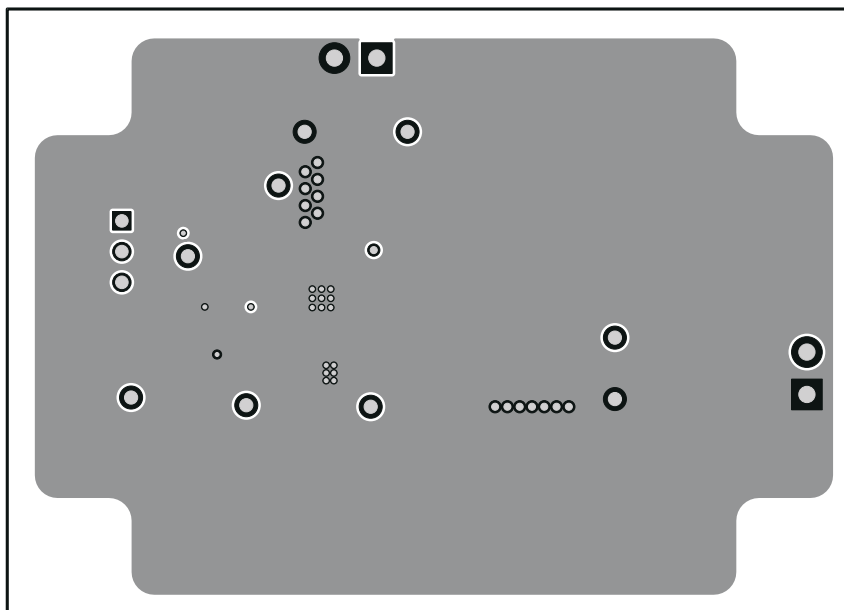

**Figure 5-4. Internal Layer 2**

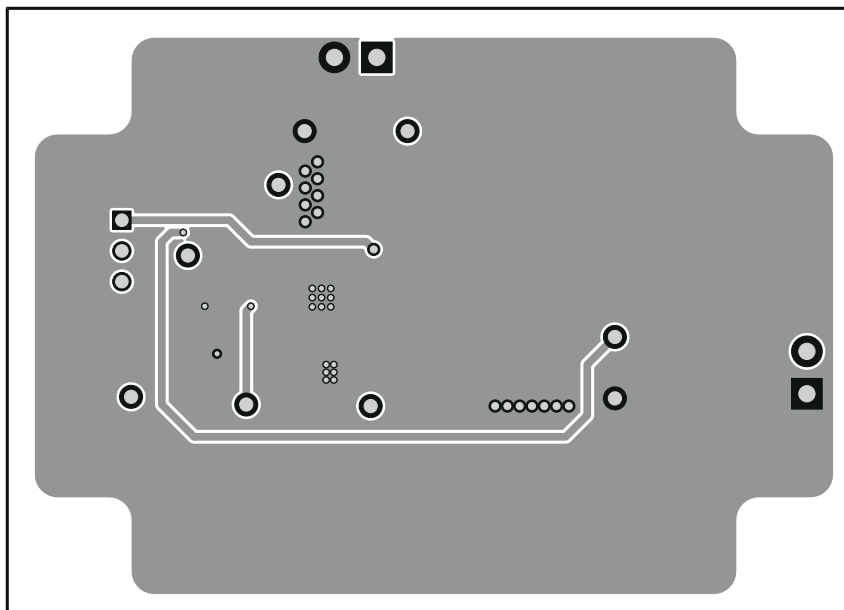

**Figure 5-5. Bottom Layer**

## 6 Schematic, Bill of Materials, and Reference

### 6.1 Schematic

Figure 6-1 is the schematic for the TPS54627EVM-052.

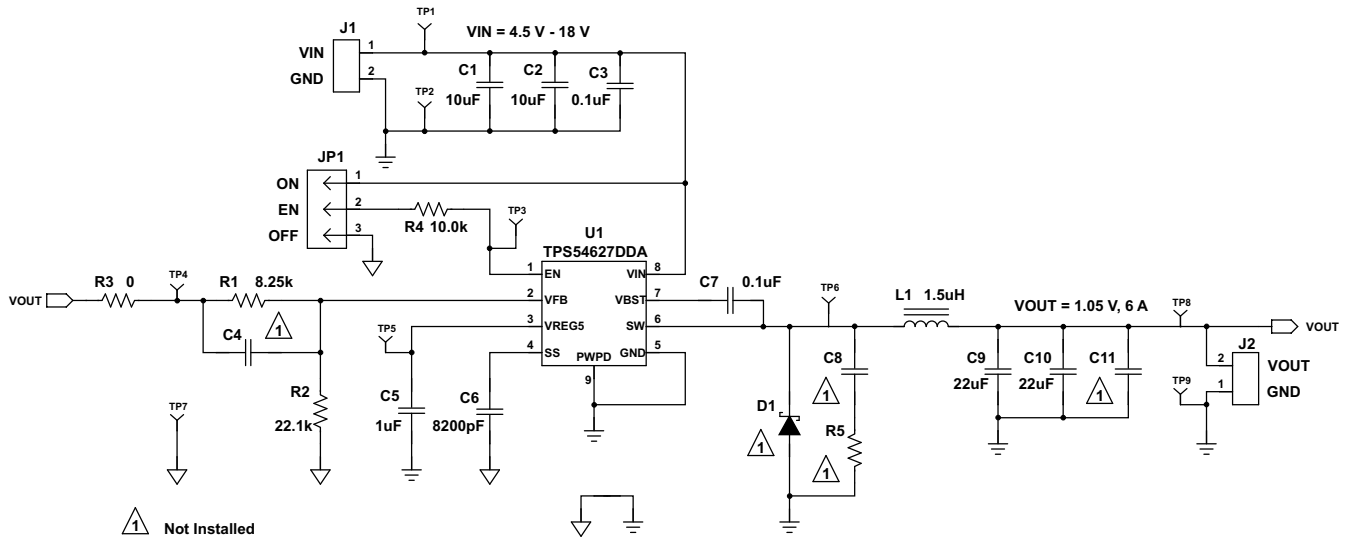

Figure 6-1. TPS54627EVM-052 Schematic Diagram



## 6.2 Bill of Materials

**Table 6-1. Bill of Materials**

REFDES	QTY	VALUE	DESCRIPTION	SIZE	PART NUMBER	MFR
C1, C2	2	10 $\mu$ F	Capacitor, Ceramic, 25 V, X5R, 20%	1210	Std	Std
C3, C7	2	0.1 $\mu$ F	Capacitor, Ceramic, 50 V, X7R, 10%	0603	Std	Std
C4, C8	0	Open	Capacitor, Ceramic	0603	Std	Std
C5	1	1 $\mu$ F	Capacitor, Ceramic, 16 V, X7R, 10%	0603	Std	Std
C6	1	8200 pF	Capacitor, Ceramic, 25 V, X7R, 10%	0603	Std	Std
C9, C10	2	22 $\mu$ F	Capacitor, Ceramic, 6.3 V, X5R, 20%	1206	C3216X5R0J226M	TDK
C11	1	Open	Capacitor, Ceramic	1206	Std	Std
D1	0	Open	Diode, 0.5 A, 30 V, 2PIN	TUMD2	RSX051VA-30	Rohm
J1, J2	2	ED555/2DS	Terminal Block, 2-pin, 6-A, 3.5 mm	0.27 x 0.25 inch	ED555/2DS	Sullins
JP1	1	PEC03SAAN	Header, Male 3-pin, 100-mil spacing	0.100 inch x 3	PEC03SAAN	Sullins
L1	1	1.5 $\mu$ H	Inductor, SMT, 11.6 A, 10.67 milli $\Omega$	0.256 x 0.280 inch	SPM6530T-1R5M100	TDK
R1	1	8.25 k	Resistor, Chip, 1/16W, 1%	0603	Std	Std
R2	1	22.1 k	Resistor, Chip, 1/16W, 1%	0603	Std	Std
R3, R5	2	0	Resistor, Chip, 1/16W, 1%	0603	Std	Std
R4	1	10.0 k	Resistor, Chip, 1/16W, 1%	0603	Std	Std
R5	0	Open	Resistor, Chip, 1/16W, 1%	0603	Std	Std
TP1, TP3, TP4, TP5, TP6, TP8	3	5000	Test Point, Red, Thru Hole Color Keyed	0.100 x 0.100 inch	5000	Keystone
TP2, TP7, TP9	3	5001	Test Point, Black, Thru Hole Color Keyed	0.100 x 0.100 inch	5001	Keystone
U1	1	TPS54627DDA	IC, 4.5-18 V Input, 6-A Sync. Step-Down Converter	SO8[DDA]	TPS54627DDA	TI
-	1		Shunt, 100-mil, Black	0.100	929950-00	3M
-	1		PCB		PWR056	Any

## 6.3 Reference

Texas Instruments, [TPS54627, 4.5-V to 18-V Input, 6-A Synchronous Step-Down Converter Data Sheet](#)

## 7 Revision History

NOTE: Page numbers for previous revisions may differ from page numbers in the current version.

Changes from Revision * (April 2013) to Revision A (August 2021)	Page
• Updated user's guide title.....	3
• Updated the numbering format for tables, figures, and cross-references throughout the document. ....	3
• Edited user's guide for clarity.....	3

## IMPORTANT NOTICE AND DISCLAIMER

TI PROVIDES TECHNICAL AND RELIABILITY DATA (INCLUDING DATA SHEETS), DESIGN RESOURCES (INCLUDING REFERENCE DESIGNS), APPLICATION OR OTHER DESIGN ADVICE, WEB TOOLS, SAFETY INFORMATION, AND OTHER RESOURCES "AS IS" AND WITH ALL FAULTS, AND DISCLAIMS ALL WARRANTIES, EXPRESS AND IMPLIED, INCLUDING WITHOUT LIMITATION ANY IMPLIED WARRANTIES OF MERCHANTABILITY, FITNESS FOR A PARTICULAR PURPOSE OR NON-INFRINGEMENT OF THIRD PARTY INTELLECTUAL PROPERTY RIGHTS.

These resources are intended for skilled developers designing with TI products. You are solely responsible for (1) selecting the appropriate TI products for your application, (2) designing, validating and testing your application, and (3) ensuring your application meets applicable standards, and any other safety, security, regulatory or other requirements.

These resources are subject to change without notice. TI grants you permission to use these resources only for development of an application that uses the TI products described in the resource. Other reproduction and display of these resources is prohibited. No license is granted to any other TI intellectual property right or to any third party intellectual property right. TI disclaims responsibility for, and you will fully indemnify TI and its representatives against, any claims, damages, costs, losses, and liabilities arising out of your use of these resources.

TI's products are provided subject to [TI's Terms of Sale](#) or other applicable terms available either on [ti.com](http://ti.com) or provided in conjunction with such TI products. TI's provision of these resources does not expand or otherwise alter TI's applicable warranties or warranty disclaimers for TI products.

TI objects to and rejects any additional or different terms you may have proposed.

Mailing Address: Texas Instruments, Post Office Box 655303, Dallas, Texas 75265  
Copyright © 2022, Texas Instruments Incorporated