

DS90UB96X-Q1EVM User's Guide

User's Guide



Literature Number: SNLU177
July 2016

1	DS90UB96X-Q1EVM User's Guide	5
1.1	General Description	5
1.2	Features	6
1.3	System Requirements	7
1.4	Contents of the Demo Evaluation Kit	7
1.5	Applications Diagram	7
1.6	Typical Configuration	8
1.7	Quick Start Guide	9
1.8	Demo Board Connections	9
1.8.1	Power Supply	9
1.8.2	Power Over Coax Interface	10
1.8.3	MIPI CSI-2 Output Signals	11
1.8.4	FPD-Link III Signals	13
1.8.5	I ² C Interface	13
1.8.6	Control Interface	14
1.9	Enable and Reset	15
1.10	ALP Software Setup	16
1.10.1	System Requirements	16
1.10.2	Download Contents	16
1.10.3	Installation of the ALP Software	16
1.10.4	Startup - Software Description	17
1.10.5	Information Tab	18
1.10.6	Registers Tab	19
1.10.7	Registers Tab - Address 0x00 Selected	20
1.10.8	Registers Tab - Address 0x00 Expanded	21
1.10.9	Scripting Tab	22
1.10.10	Sample ALP Python Script	22
1.10.10.1	Initialization	22
1.11	Troubleshooting ALP Software	27
1.11.1	ALP Loads the Incorrect Profile	27
1.11.2	ALP does not detect the EVM	30
1.12	Typical Connection and Test Equipment	32
1.13	Termination Device	32
1.14	Typical Test Setup	32
1.15	Equipment References	34
1.16	Cable References	34
1.17	Bill of Materials	35
2	PCB Schematics	46
3	Board Layout	53

List of Figures

1-1.	Applications Diagram	7
1-2.	Typical Configuration	8
1-3.	Interfacing to the EVM	9
1-4.	Power Over Coax Network	10
1-5.	Launching ALP	17
1-6.	Initial ALP Screen	17
1-7.	Follow-up Screen	18
1-8.	ALP Information Tab	18
1-9.	ALP Registers Tab	19
1-10.	ALP Device ID Selected	20
1-11.	ALP Device ID Expanded	21
1-12.	ALP Scripting Tab	22
1-13.	USB2ANY Setup	27
1-14.	Remove Incorrect Profile	28
1-15.	Add Correct Profile	28
1-16.	Finish Setup	29
1-17.	ALP No Devices Error	30
1-18.	Windows 7, ALP USB2ANY Driver	30
1-19.	ALP in Demo Mode	31
1-20.	ALP Preferences Menu	31
1-21.	Typical Test Setup for Application	32
1-22.	Typical Test Setup for Evaluation	33
3-1.	Top Overlay	53
3-2.	Top Solder	54
3-3.	Top Layer 1	54
3-4.	Layer 2	55
3-5.	Layer 3	55
3-6.	Layer 4	56
3-7.	Layer 5	56
3-8.	Bottom Layer 6	57
3-9.	Bottom solder	57
3-10.	Bottom Overlay	58

List of Tables

1-1.	Orderable EVM Variants	5
1-2.	Power Supply.....	9
1-3.	Power Over Coax Power Supply Feed Configuration	11
1-4.	MIPI CSI-2 (TX Port 0) Output Signals - J6 Pinout	11
1-5.	MIPI CSI-2 (TX Port 1) Output Signals - J7 Pinout	12
1-6.	MIPI CSI-2 (Assembly Variant SV601176-002) Output Signals - J31 Pinout	13
1-7.	FPD-Link III Signals.....	13
1-8.	IDx I ² C Device Address Select - J34	14
1-9.	Primary I ² C Interface Header - J4.....	14
1-10.	Secondary I ² C Interface Header - J5	14
1-11.	I ² C VDDIO Interface Header - J30	14
1-12.	VDDIO Interface Header - J1	14
1-13.	GPIO Interface Header - J2.....	14
1-14.	CMLOUTP Output Signals	15
1-15.	Mode SW-DIP4 - S1	15
1-16.	Control SW-DIP2 - SW1.....	15
1-17.	LEDs	15
1-18.	BOM for DS90UB96X-Q1EVM Assembly Variant SV601176-001	35
1-19.	BOM for DS90UB96X-Q1EVM Assembly Variant SV601176-002	41

DS90UB96X-Q1EVM User's Guide

1.1 General Description

The Texas Instruments DS90UB96X-Q1EVM evaluation module (EVM) is a functional board design for evaluating the FPD-Link III Deserializer to MIPI CSI-2 ADAS (Advanced Driver Assistance Systems) Hub. This kit will demonstrate the functionality and operation of the DS90UB96X-Q1 family of chipsets. The information provided in this document can be applied to devices such as DS90UB964-Q1. This EVM can also be used as a hardware reference design for any implementation of the DS90UB96X-Q1 series. Some portions and components in the EVM or in this document may include the references to DS90UB964-Q1 instead of addressing all part numbers. For the purposes of this document, the DS90UB964-Q1 is interchangeable with the DS90UB96X-Q1.

The DS90UB96X-Q1 is a versatile camera hub capable of connecting serialized camera data received from up to 4 independent video datastreams via an FPD-Link III interface using standard coaxial cables. When coupled with DS90UB913A/913Q serializers, the DS90UB964-Q1 receives data from 1-Megapixel imagers supporting HD 720p/800p/960p resolution at 30/60Hz frame rates. The DS90UB96X-Q1 merges and manages multiple data streams into a MIPI CSI-2 compliant output for interconnect to a downstream processor.

The EVM is a development add-on module to add surround view capability to any of a variety of video processor systems such as the TI TDA3x ADAS Processor, or an Applications Processor, Image Signal Processor (ISP), and SOC. The system consists of four cameras each of which receives control information and power through FAKRA coaxial cables, and uses the same cable to return the video information to an EVM board. Each of the FPD-Link III interfaces also includes a separate low latency bi-directional control channel that conveys control information from an I²C port. General purpose I/O signals such as those required for camera synchronization and functional safety features also make use of this bi-directional control channel.

NOTE: The demo board is not intended for EMI testing. The demo board was designed for easy accessibility to device pins with tap points for monitoring or applying signals, additional pads for termination, and multiple connector options.

The Texas Instruments DS90UB96X-Q1EVM helps to evaluate the operation and performance of the DS90UB964-Q1 and is available for order in two variants. See [Table 1-1](#) of orderable EVM variants and configuration.

Table 1-1. Orderable EVM Variants

EVM Orderable Name	EVM Variant	POC Network	Description
DS90UB964-Q1EVM	SV601176-001	DS90UB913A Compatible	Samtec QSH connector
DS90UB964-Q1EVMTDA	SV601176-002	DS90UB913A Compatible	Samtec QTH connector to TDA3X EVM

1.2 Features

- Aggregates data from up to 4 cameras over FPD-Link III interface
- Supports 1-Megapixel sensors with HD 720P/800P/960P resolution at 30/60Hz frame rate (paired w/ DS90UB913A)
- Multi-camera synchronization
- Supports MIPI DPHY 1.2 / CSI-2 Version 1.3 compliant
 - 2x CSI-2 output ports
 - Supports 1, 2, 3, 4 data lanes per CSI-2 port
 - CSI-2 data rate scalable for 400 Mbps / 800 Mbps / 1.6 Gbps per data lane
 - Programmable data types
 - Four Virtual Channels
 - ECC and CRC generation
- Supports Single-ended Coax cable and Power Over Coax
- Adaptive receive equalization
- I²C with Fast-mode Plus up to 1 Mbps
- Flexible GPIOs for camera sync and functional safety
- Single +12V power supply for EVM

1.3 System Requirements

The major components of the DS90UB96X-Q1EVM are:

- DS90UB964-Q1
- On-board Power-over-Coax (POC) interface
- Four Fakra coax connectors for digital video, power, control and diagnostics
- Samtec QSH type connectors on CSI-2 interfaces
- On-board I²C programming interface

In order to demonstrate, the following is required (not included):

1. Four Omnivision sensor boards with DS90UB913A Serializer boards
 - (a) TI DS90UB913A-CXEVM OR TI SAT0088 'MiniSer'
 - AND
 - (b) OV10635 P/N: OV10635-EAAE-AA0A OR OV10640 P/N: OV10640-EAAA-AA0A (DVP)
2. Four TIDA-00262 Aptina AR0140 sensor modules and DS90UB913A Serializer
3. Four DACAR/FAKRA coax cables
4. I²C host controller that support clock stretching
5. Applications Processor Card
6. Power supply for 12V @ 2A

1.4 Contents of the Demo Evaluation Kit

- One EVM board with the DS90UB96X-Q1

1.5 Applications Diagram

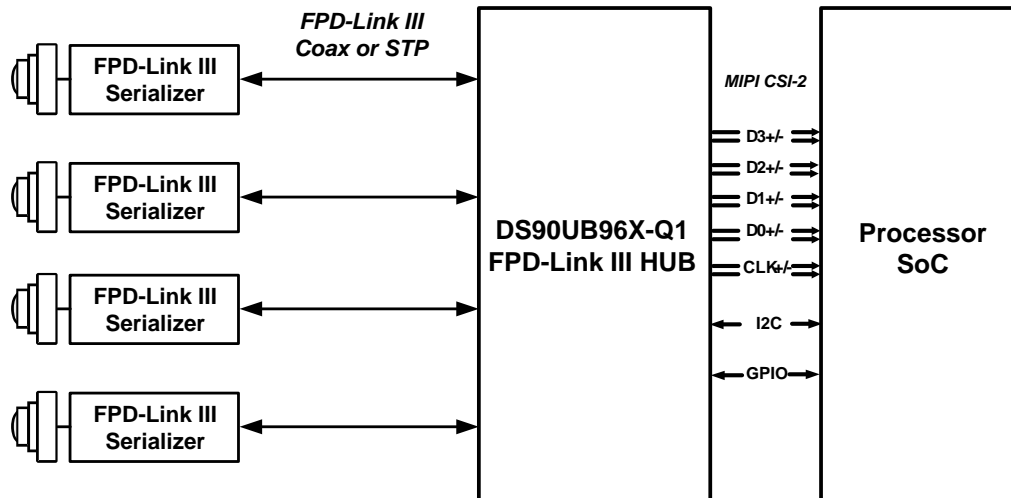

Figure 1-1. Applications Diagram

1.6 Typical Configuration

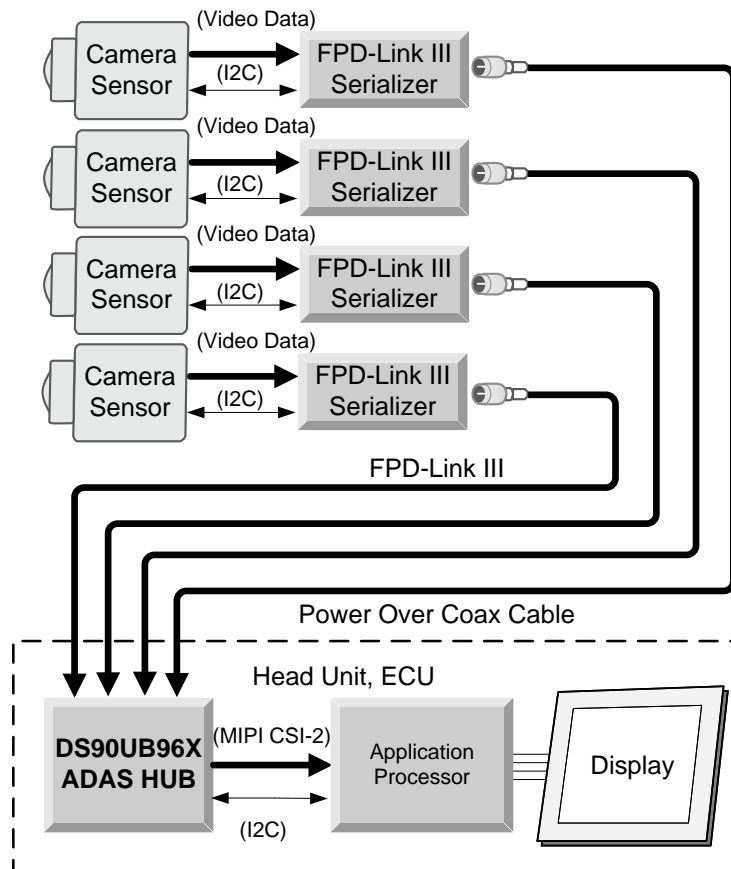

Figure 1-2. Typical Configuration

1.7 Quick Start Guide

1. Connect mini USB J36 to USB port for register programming
2. **Optional** : Connect an external I²C host adapter I²C signals on J4 port for register programming
3. Configure switches S1 and SW1 to set device's operating modes
4. Configure VFEED power supply for each channel of CN1, CN2, CN3, CN4 on J32 header
5. Plug the four sensors into the four DS90UB913A serializer boards to create four camera modules
6. Connect the four camera modules to channels 1, 2, 3, and 4 using coax cables on CN1, CN2, CN3, CN4
7. Interface MIPI CSI-2 output signals (J6 or J7) to application processor
8. Provide power to board on J24 (+12VDC)
 - (a) Optional +1.1VDC power supply on J22
 - (b) Optional +1.8VDC power supply on J28
 - (c) Optional +3.3VDC power supply on J29
9. For details of pin-names and pin-functions, please refer to the DS90UB96X-Q1 datasheet.

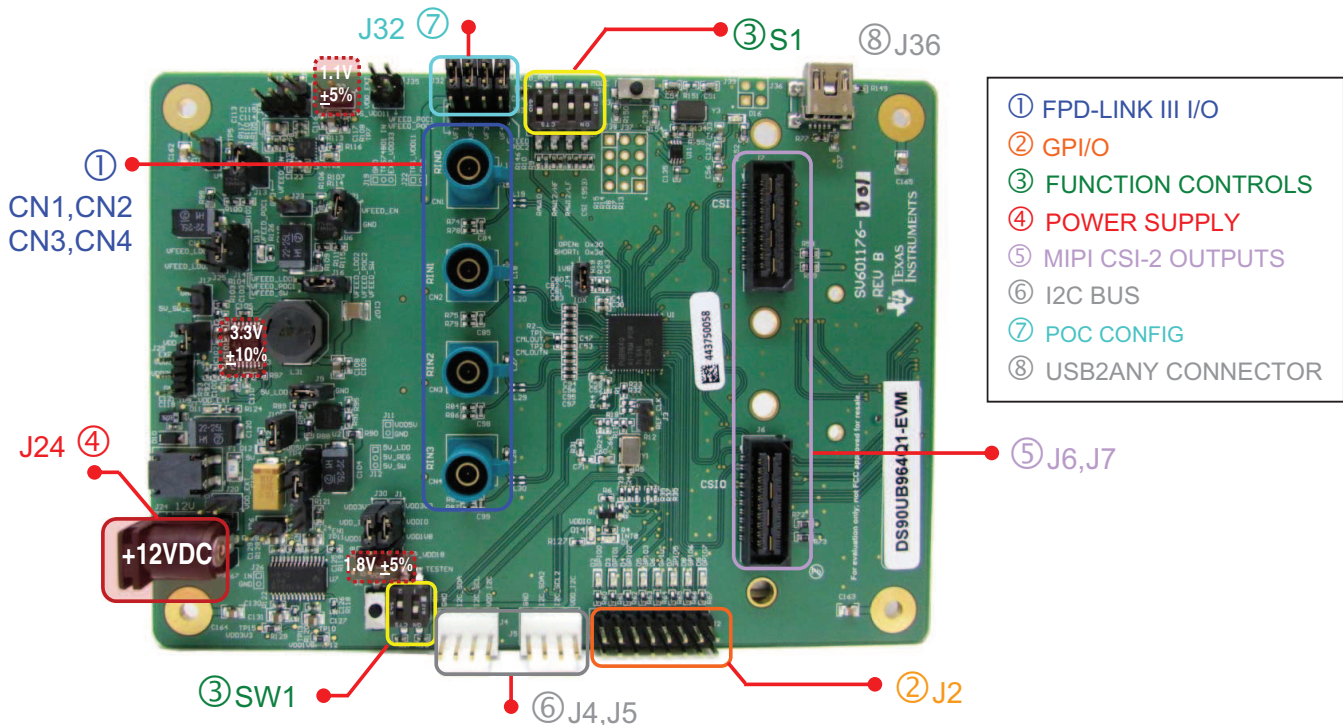

Figure 1-3. Interfacing to the EVM

1.8 Demo Board Connections

1.8.1 Power Supply

Table 1-2. Power Supply

Reference	Signal	Description
J20.1	+12V	Main Power Single +12VDC (nominal) power connector that supplies power to the entire board.
J22.1 (Optional)	+1.1V	1.1V ±5% Alternative to Main Power

Table 1-2. Power Supply (continued)

Reference	Signal	Description
J28.2 (Optional)	+1.8V	1.8V \pm 5% Alternative to Main Power
J29.2 (Optional)	+3.3V	3.3V \pm 5% Alternative to Main Power

1.8.2 Power Over Coax Interface

The DS90UB96X-Q1EVM offers four power over coax interfaces (POC) to connect cameras through a coaxial cable with FAKRA connectors. Power is delivered on the same conductor that is used to transmit video and control channel between the host and the camera. By default, 5V power supply is applied over the coax cable. Refer [Table 1-3](#) to for other POC configurations.

For power over coax (POC) on the EVM, the circuit uses a filter network as shown in [Figure 1-4](#). The POC network frequency response corresponds to the bandwidth compatible with DS90UB913A chipsets.

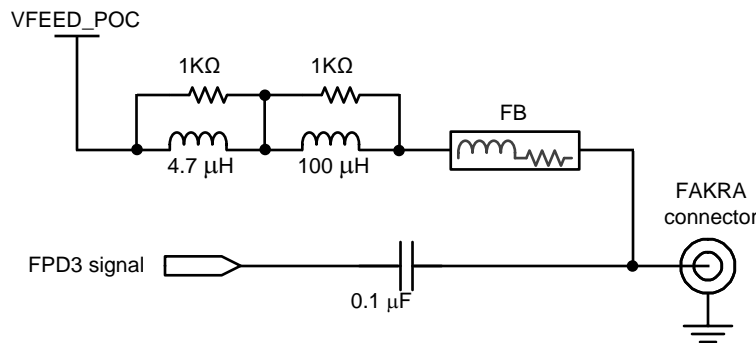

Figure 1-4. Power Over Coax Network

WARNING

Verify that the power voltage is properly set before plugging into CN1, CN2, CN3, CN4. Power supply is not fused. Overvoltage will cause damage to boards directly connected due to incorrect input power supplies.

Table 1-3. Power Over Coax Power Supply Feed Configuration

Reference	Signal	Description
J14	VFEED_POC1	Power Over Coax Power Feed Selection 1
		Short pins 1-2: +9V power supply from VFEED_LDO1
		Short pins 2-3: +5V power supply from 5V_SW (Default)
J16	VFEED_POC2	Power Over Coax Power Feed Selection 2
		Short pins 1-2: +9V power supply from VFEED_LDO2
		Short pins 2-3: +5V power supply from 5V_SW (Default)
J35	VDD_EXT	Power Over Coax Power Feed using +12V Main Power (J21) Note: J16 and J14 must to left OPEN if using this configuration
		Short pins 1-2: +12V power supply to VFEED_POC1
		Short pins 2-3: +12V power supply to VFEED_POC2
J32.1	VFEED1	Remote power supply connection to CN1
		Short J32.1-2: VFEED_POC1 (Default)
		Short J32.1 & J33.1: VFEED_POC2
J32.3	VFEED2	Remote power supply connection to CN2
		Short J32.3-4: VFEED_POC1 (Default)
		Short J32.3 & J33.2: VFEED_POC2
J32.5	VFEED3	Remote power supply connection to CN3
		Short J32.5-6: VFEED_POC1 (Default)
		Short J32.5 & J33.3: VFEED_POC2
J32.7	VFEED4	Remote power supply connection to CN4
		Short J32.7-8: VFEED_POC1 (Default)
		Short J32.7 & J33.4: VFEED_POC2

1.8.3 MIPI CSI-2 Output Signals

Provided on the DS90UB96X-Q1EVM, J6 and J7 are Samtec QSH-type connectors that can be mated with a matching QTH type connector on the top. This Samtec connector provides a means to route CSI-2 signals out of the DS90UB96X-Q1. The J6 and J7 corresponds to CSI0 Port and CSI1 Port output connection signals respectively, and includes access to I²C and other miscellaneous GPIO signals. Zero ohm resistor pads are available if a connection to other signals is required. The mating connector part number is QTH-020-01-H-D-DP-A.

There are third party solutions like the HDR-128291-XX breakout board from Samtec which can be used. The HDR- 128291-XX is a breakout board with a mating connector to J6 & J7 and standard SMA male connectors. More info on this breakout board can be obtained from Samtec website. Another third party option is the ZX100 by Zebax Technologies. More information on this board can be obtained from Zebax website.

Table 1-4. MIPI CSI-2 (TX Port 0) Output Signals - J6 Pinout

Pin #	Signal Name	Pin #	Signal Name
1	NC	2	EXP_SCL0 (I2C_SCL or I2C_SCL2)
3	NC	4	EXP_SDA0 (I2C_SDA or I2C_SDA2)
5	CSI0_CLK_P	6	NC
7	CSI0_CLK_N	8	NC
9	CSI0_D0_P	10	EXP_REF_CLK0 (REFCLK)
11	CSI0_D0_N	12	GND
13	CSI0_D1_P	14	RESETn_0 (PDB)

Table 1-4. MIPI CSI-2 (TX Port 0) Output Signals - J6 Pinout (continued)

Pin #	Signal Name	Pin #	Signal Name
15	CSI0_D1_N	16	GND
17	CSI0_D2_P	18	SPI_MOSI_0 (GPIO0 or GPIO3)
19	CSI0_D2_N	20	SPI_SCLK_0 (GPIO1 or GPIO4)
21	CSI0_D3_P	22	SPI_CS _n _0 (GPIO2 or GPIO5)
23	CSI0_D3_N	24	GND
25	NC	26	NC
27	NC	28	NC
29	NC	30	VDD_3V3
31	NC	32	VDD_3V3
33	NC	34	VDD_3V3
35	NC	36	VDD_3V3
37	NC	38	VDD_1V8
39	NC	40	VDD_1V8

Table 1-5. MIPI CSI-2 (TX Port 1) Output Signals - J7 Pinout

Pin #	Signal Name	Pin #	Signal Name
1	NC	2	EXP_SCL1 (I2C_SCL or I2C_SCL2)
3	NC	4	EXP_SDA1 (I2C_SDA or I2C_SDA2)
5	CSI1_CLK_P	6	NC
7	CSI1_CLK_N	8	NC
9	CSI1_D0_P	10	EXP_REF_CLK1 (REFCLK)
11	CSI1_D0_N	12	GND
13	CSI1_D1_P	14	RESET _n _1 (PDB)
15	CSI1_D1_N	16	GND
17	CSI1_D2_P	18	SPI_MOSI_1 (GPIO0 or GPIO3)
19	CSI1_D2_N	20	SPI_SCLK_1 (GPIO1 or GPIO4)
21	CSI1_D3_P	22	SPI_CS _n _1 (GPIO2 or GPIO5)
23	CSI1_D3_N	24	GND
25	NC	26	NC
27	NC	28	NC
29	NC	30	VDD_3V3
31	NC	32	VDD_3V3
33	NC	34	VDD_3V3
35	NC	36	VDD_3V3
37	NC	38	VDD_1V8
39	NC	40	VDD_1V8

Table 1-6. MIPI CSI-2 (Assembly Variant SV601176-002) Output Signals - J31 Pinout

Pin #	Signal Name	Pin #	Signal Name
1	NC	2	EXP_SCL0 (I2C_SCL or I2C_SCL2)
3	NC	4	EXP_SDA0 (I2C_SDA or I2C_SDA2)
5	CSI0_CLK_P	6	NC
7	CSI0_CLK_N	8	NC
9	CSI0_D0_P	10	EXP_REF_CLK0 (REFCLK)
11	CSI0_D0_N	12	GND
13	CSI0_D1_P	14	RESETn_0 (PDB)
15	CSI0_D1_N	16	GND
17	CSI0_D2_P	18	SPI_MOSI_0 (GPIO0 or GPIO3)
19	CSI0_D2_N	20	SPI_SCLK_0 (GPIO1 or GPIO4)
21	CSI0_D3_P	22	SPI_CS _n _0 (GPIO2 or GPIO5)
23	CSI0_D3_N	24	GND
25	CSI1_CLK_P	26	NC
27	CSI1_CLK_N	28	NC
29	CSI1_D0_P	30	VDD_3V3
31	CSI1_D0_N	32	VDD_3V3
33	CSI1_D1_P	34	VDD_3V3
35	CSI1_D1_N	36	VDD_3V3
37	NC	38	VDD_1V8
39	NC	40	VDD_1V8

NOTE: * Remove R130-R145 for CSI-2 source connected to J6/J7 *

** Populate R130-R145 when source connected through J31 **

1.8.4 FPD-Link III Signals

Table 1-7. FPD-Link III Signals

Reference	Signal	Description
CN1	RIN0+	FAKRA connector
CN2	RIN1+	FAKRA connector
CN3	RIN2+	FAKRA connector
CN4	RIN3+	FAKRA connector

1.8.5 I²C Interface

A standalone external I²C host can connect via J4, J5 for programming purposes. Examples of external I²C host controllers are Texas Instruments USB2ANY and Total Phase Aardvark I²C/SPI host adapter (Total Phase Part#: TP240141).

Optional access to I²C signals are also available via CSI-2 connectors J6, J7, or J31. I²C signal levels can be configured through J30 to be at 1.8V or 3.3V when the I²C interface is accessed through connectors J4, J5.

Table 1-8. IDx I²C Device Address Select - J34

Reference	Signal	Description
J34	IDX	Selects I ² C Device Address
		Open: 0x30 (7'b) or 0x60 (8'b)
		Short: 0x3D (7'b) or 0x7A (8'b) (Default)

Table 1-9. Primary I²C Interface Header - J4

Reference	Signal	Description
J4.1	VDD_I2C	External I ² C bus voltage
J4.2	I2C_SCL	I ² C Clock Interface for primary I ² C bus
J4.3	I2C_SDA	I ² C Data Interface for primary I ² C bus
J4.4	GND	Ground

Table 1-10. Secondary I²C Interface Header - J5

Reference	Signal	Description
J5.1	VDD_I2C	External I ² C bus voltage
J5.2	I2C_SCL2	I ² C Clock Interface for secondary I ² C bus
J5.3	I2C_SDA2	I ² C Data Interface for secondary I ² C bus
J5.4	GND	Ground

Table 1-11. I²C VDDIO Interface Header - J30

Reference	Signal	Description
J30	VDD_I2C	Selects I ² C IO bus voltage
		Short pins 1-2: 3.3V IO (Default)
		Short pins 2-3: 1.8V IO

1.8.6 Control Interface

Table 1-12. VDDIO Interface Header - J1

Reference	Signal	Description
J1	VDDIO	Selects VDDIO bus voltage
		Short pins 1-2: 3.3V IO (Default)
		Short pins 2-3: 1.8V IO

Table 1-13. GPIO Interface Header - J2

Reference	Signal	Description
J2.2	GPIO0	General Purpose Input/Output 0
J2.4	GPIO1	General Purpose Input/Output 1
J2.6	GPIO2	General Purpose Input/Output 2
J2.8	GPIO3	General Purpose Input/Output 3
J2.10	GPIO4	General Purpose Input/Output 4
J2.12	GPIO5	General Purpose Input/Output 5
J2.14	GPIO6	General Purpose Input/Output 6
J2.16	GPIO7	General Purpose Input/Output 7

Table 1-14. CMLOUTP Output Signals

Reference	Signal	Description
TP1	CMLOUTP	Test Pad for Channel Monitor Loop-through Driver
TP2	CMLOUTN	Test Pad for Channel Monitor Loop-through Driver

Table 1-15. Mode SW-DIP4 - S1⁽¹⁾

Reference	Mode	Description
S1.1	1	CSI Mode (2-MP ADAS Tx compatible) ⁽²⁾
S1.2	2	RAW12 / LF (DS90UB913A compatible)
S1.3	3	RAW12 / HF (DS90UB913A compatible)
S1.4	4	RAW10 (DS90UB913A compatible) (Default)

⁽¹⁾ Only set one ON.

⁽²⁾ This function is only available with 2-MP ADAS chipsets.

Table 1-16. Control SW-DIP2 - SW1

Reference	Signal	Input = L	Input = H	Description
SW1.1	TESTEN	For Normal operation (Default)	Test Mode enable	Test Mode
SW1.2	PDB	Device is powered down	Device is enabled (Default)	Power-down Mode

Table 1-17. LEDs

Reference	LED Name	Description
D2	GPIO0	Illuminates if GPIO0 is ON
D3	GPIO1	Illuminates if GPIO1 is ON
D4	GPIO2	Illuminates if GPIO2 is ON
D5	GPIO3	Illuminates if GPIO3 is ON
D6	GPIO4	Illuminates if GPIO48 is ON
D7	GPIO5	Illuminates if GPIO5 is ON
D8	GPIO6	Illuminates if GPIO6 is ON
D9	GPIO7	Illuminates if GPIO7 is ON
D11	VDD_EXT	Illuminates if 12V Power is applied to DC-IN J24
D12	VDD5V	Illuminates on +5V
D13	VFEED_POC	Illuminates if VFEED_POC Power is ON
D14	VDDIO	Illuminates on VDDIO Power

1.9 Enable and Reset

There are two device enable and reset/power-down options for the EVM.

- RC timing option: The C65 external capacitor and R17 pull-up resistor connected to the PDB pin ramp time after the device is powered on.
- External control option: A push-button (S2) or SW1 position 2 is available for the manual control of the PBD signal.

1.10 ALP Software Setup

1.10.1 System Requirements

Operating System:	Windows 7 64-bit
USB:	USB2ANY
USB2ANY Firmware Version:	2.5.2.0
USB:	Aardvark I ² C/SPI host adapter p/n TP240141

1.10.2 Download Contents

Latest TI Analog LaunchPAD can be downloaded from: <http://www.ti.com/tool/alp>.

Download and extract the zip file to a temporary location that can be deleted later.

The following installation instructions are for a PC running Windows 7 64-bit Operating System.

1.10.3 Installation of the ALP Software

Execute the ALP Setup Wizard program called "ALPF_setup_v_x_x_x.exe" that was extracted to a temporary location on the local drive of your PC.

There are 7 steps to the installation once the setup wizard is started:

1. Select the "Next" button.
2. Select "I accept the agreement" and then select the "Next" button.
3. Select the location to install the ALP software and then select the "Next" button.
4. Select the location for the start menu shortcut and then select the "Next" button.
5. There will then be a screen that allows the creation of a desktop icon. After selecting the desired choices select the "Next" button.
6. Select the "Install" button, and the software will then be installed to the selected location.
7. Uncheck "Launch Analog LaunchPAD" and select the "Finish" button. The ALP software will start if "Launch Analog LaunchPAD" is checked, but it will not be useful until the USB driver is installed and board is attached.

Power the DS90UB96X-Q1 EVM board with a 12 VDC power supply.

1.10.4 Startup - Software Description

Make sure all the software has been installed and the hardware is powered on and connected to the PC. Execute “Analog LaunchPAD” shortcut from the start menu. The default start menu location is under All Programs > Texas Instruments > Analog LaunchPAD vx.x.x > Analog LaunchPAD to start MainGUI.exe.



Figure 1-5. Launching ALP

The application should come up in the state shown in the figure below. If it does not, see [Section 1.11](#), “Troubleshooting ALP Software”.

Under the Devices tab click on “DS90UB964” to select the device and open up the device profile and its associated tabs.

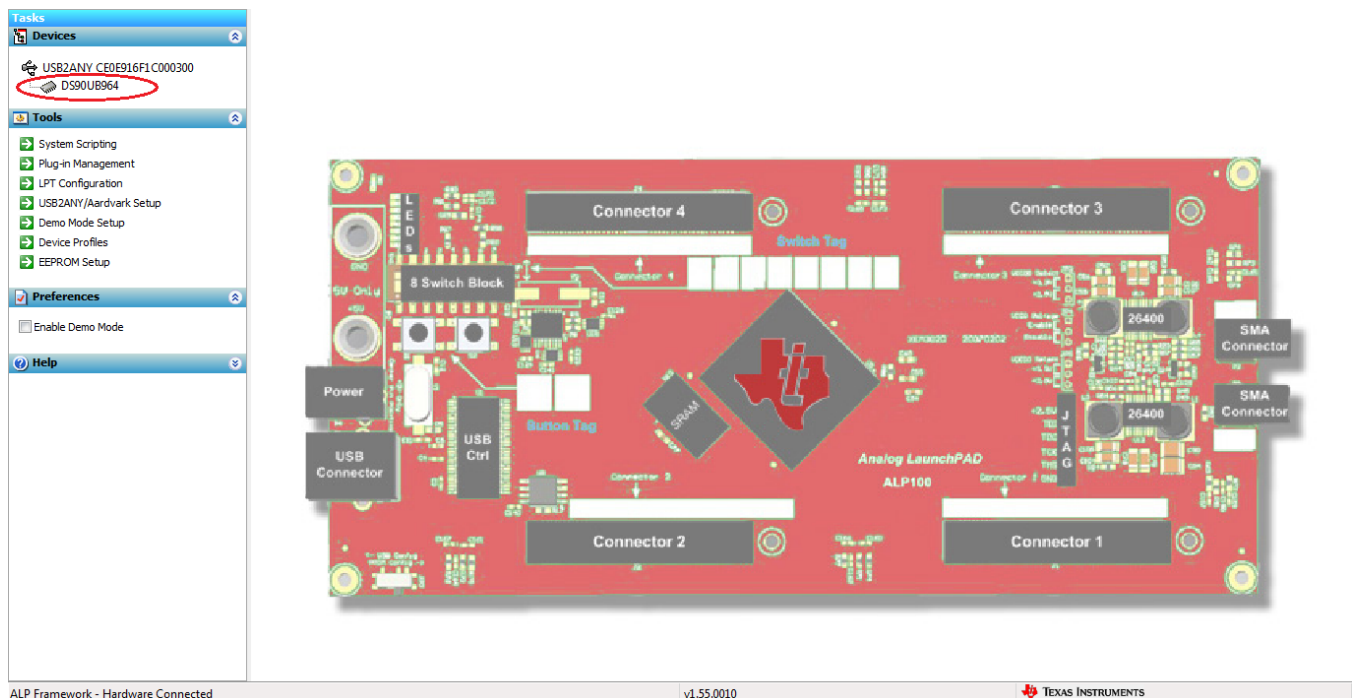

Figure 1-6. Initial ALP Screen

After selecting the DS90UB96X, the following screen shown in Figure 1-7 should appear.

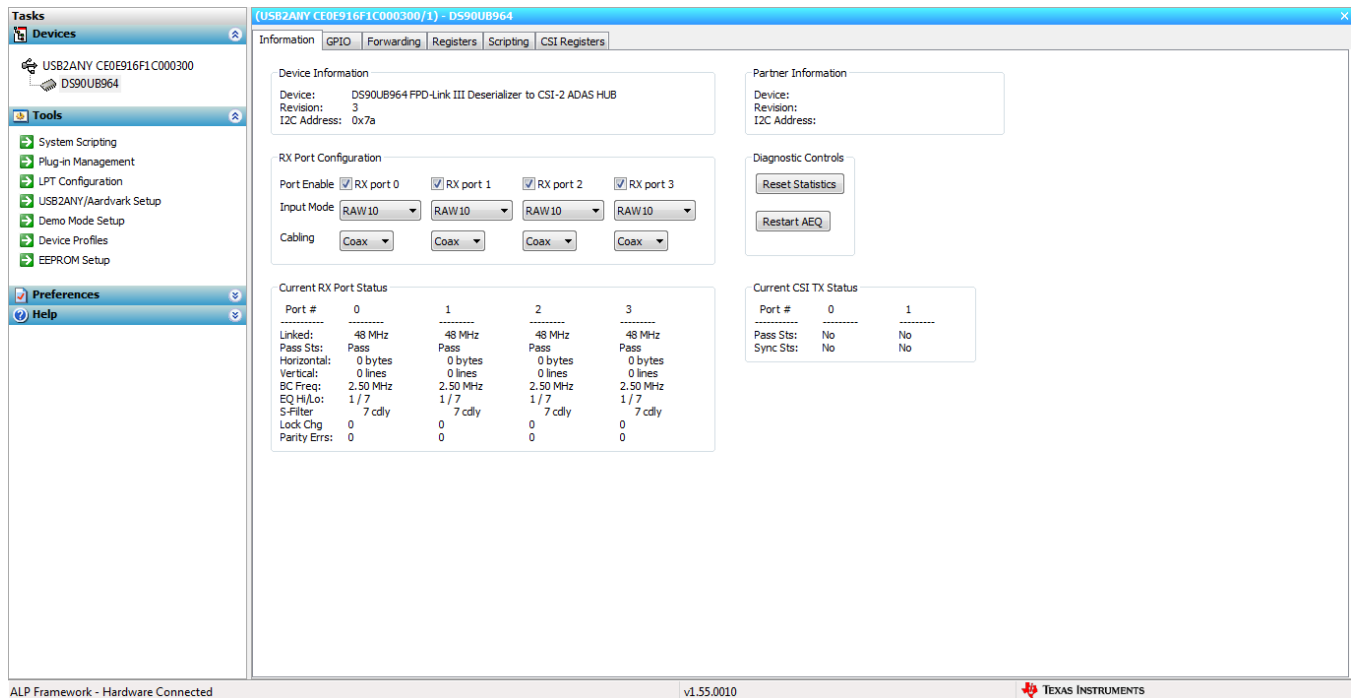

Figure 1-7. Follow-up Screen

1.10.5 Information Tab

The Information tab is shown below.

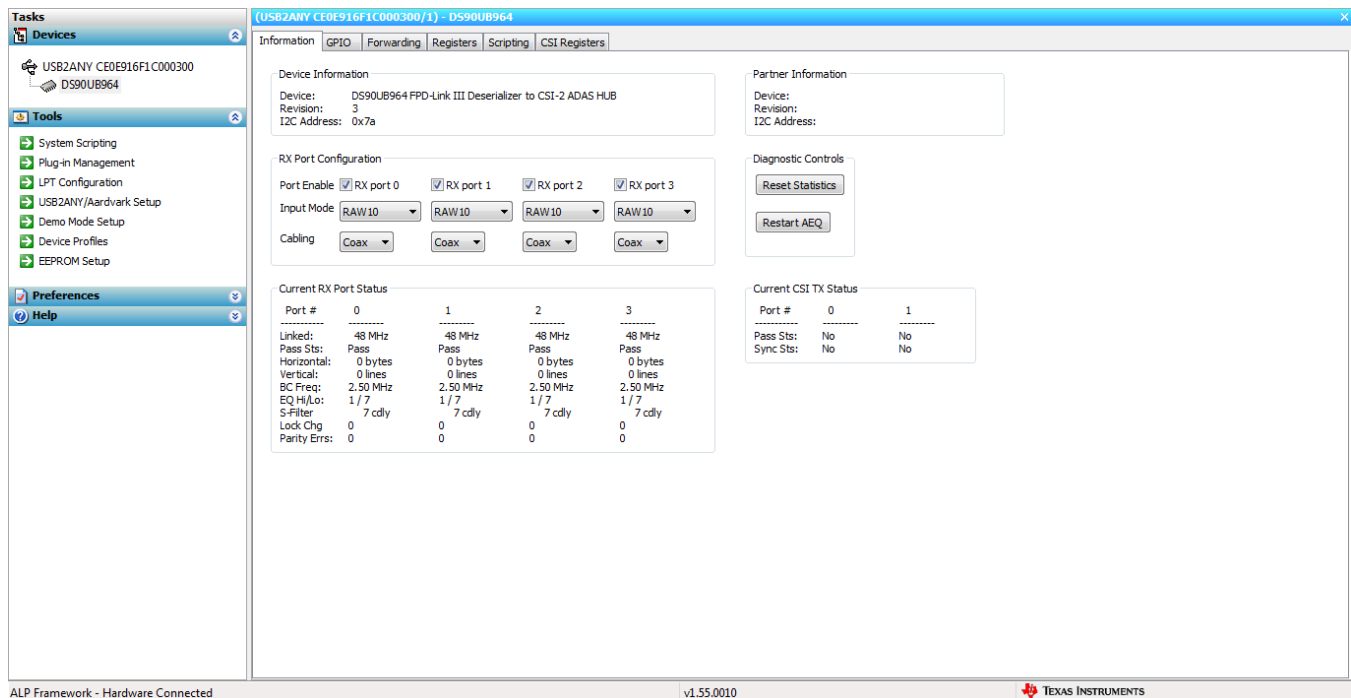

Figure 1-8. ALP Information Tab

1.10.6 Registers Tab

The Register tab is shown in [Figure 1-9](#).

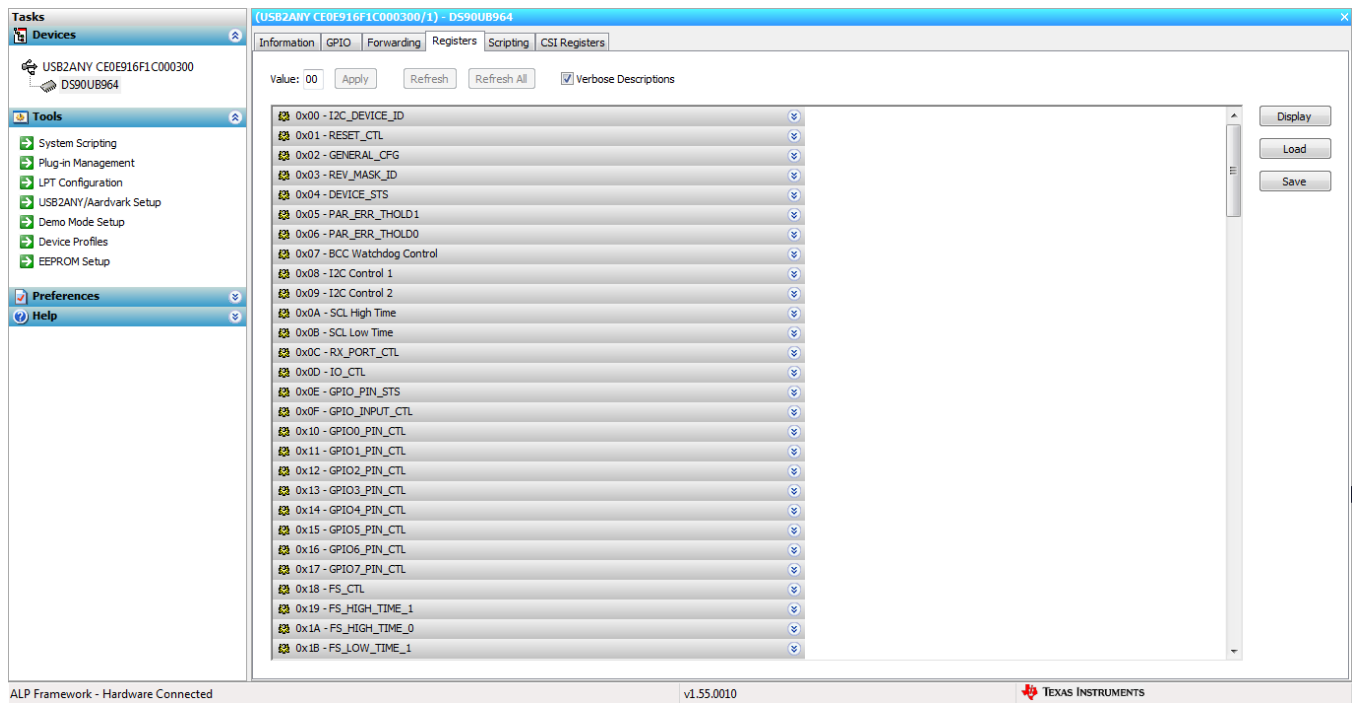

Figure 1-9. ALP Registers Tab

1.10.7 Registers Tab - Address 0x00 Selected

Address 0x00 selected as shown in Figure 1-10. Note that the “Value:” box, **Value: 7A**, will now show the hex value of that register.

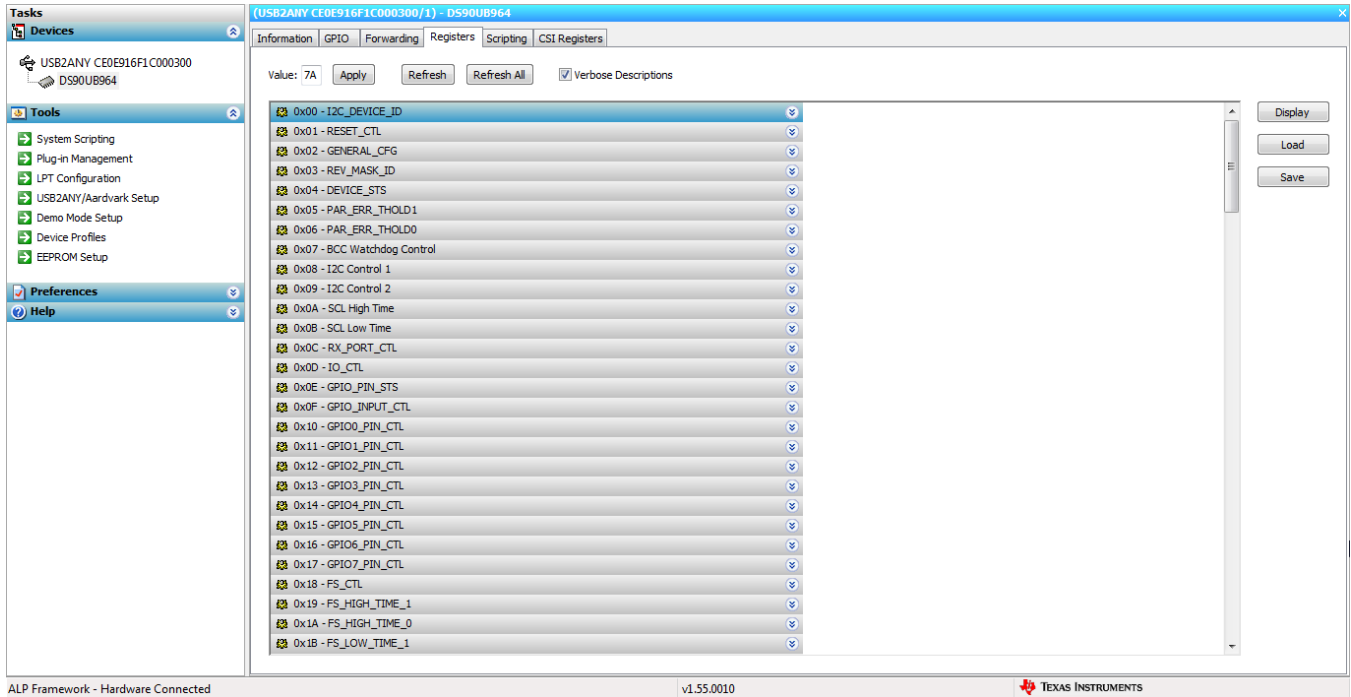



Figure 1-10. ALP Device ID Selected

1.10.8 Registers Tab - Address 0x00 Expanded

By double clicking on the Address bar



or a single click on . Address 0x00 expanded reveals contents by bits. Any register address displayed can be expanded.

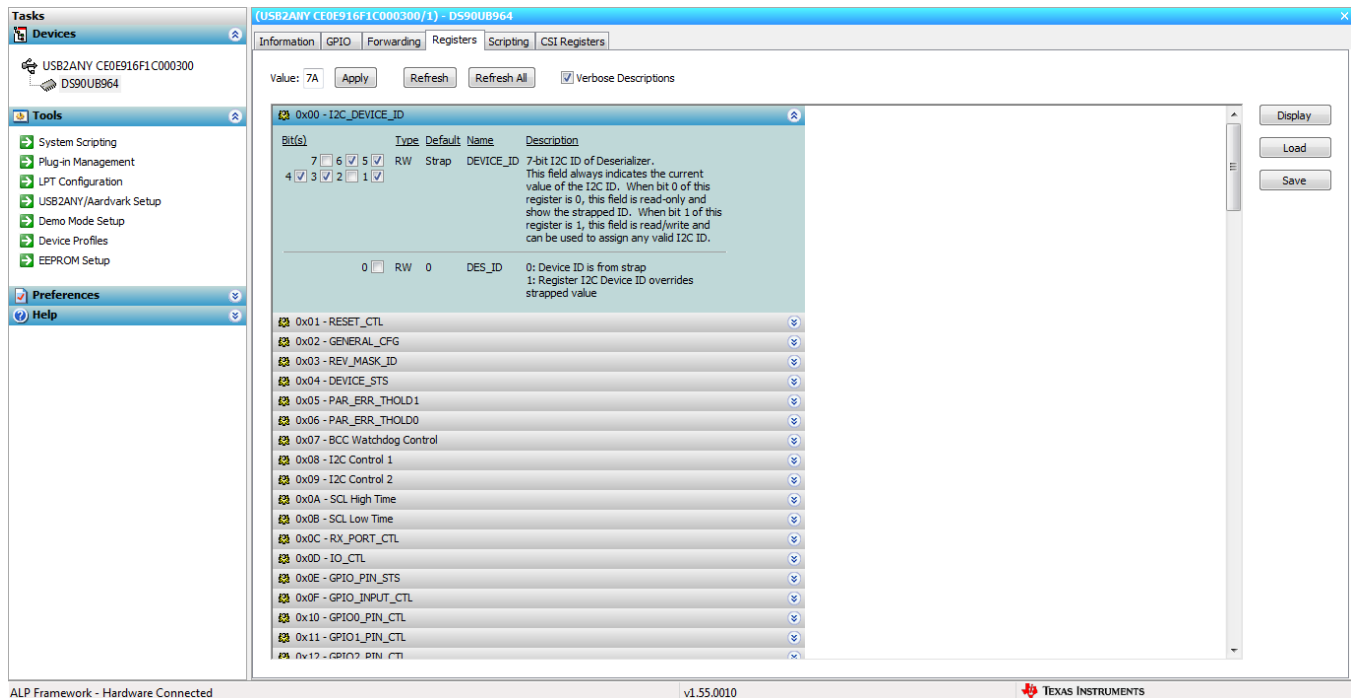
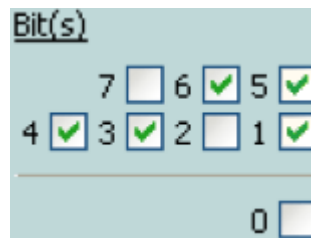

Figure 1-11. ALP Device ID Expanded

Type

Any RW Type register, **RW**, can be written into by writing the hex value into the “Value:” box, **Value: 00** or putting the pointer into the individual register bit(s) box by a left mouse click to put a check mark (indicating a “1”) or unchecking to remove the check mark (indicating a “0”). Click the “Apply” button to write to the register, and “refresh” to see the new value of the selected (highlighted) register.



The box toggles on every mouse click.

1.10.9 Scripting Tab

The Scripting tab is shown below.

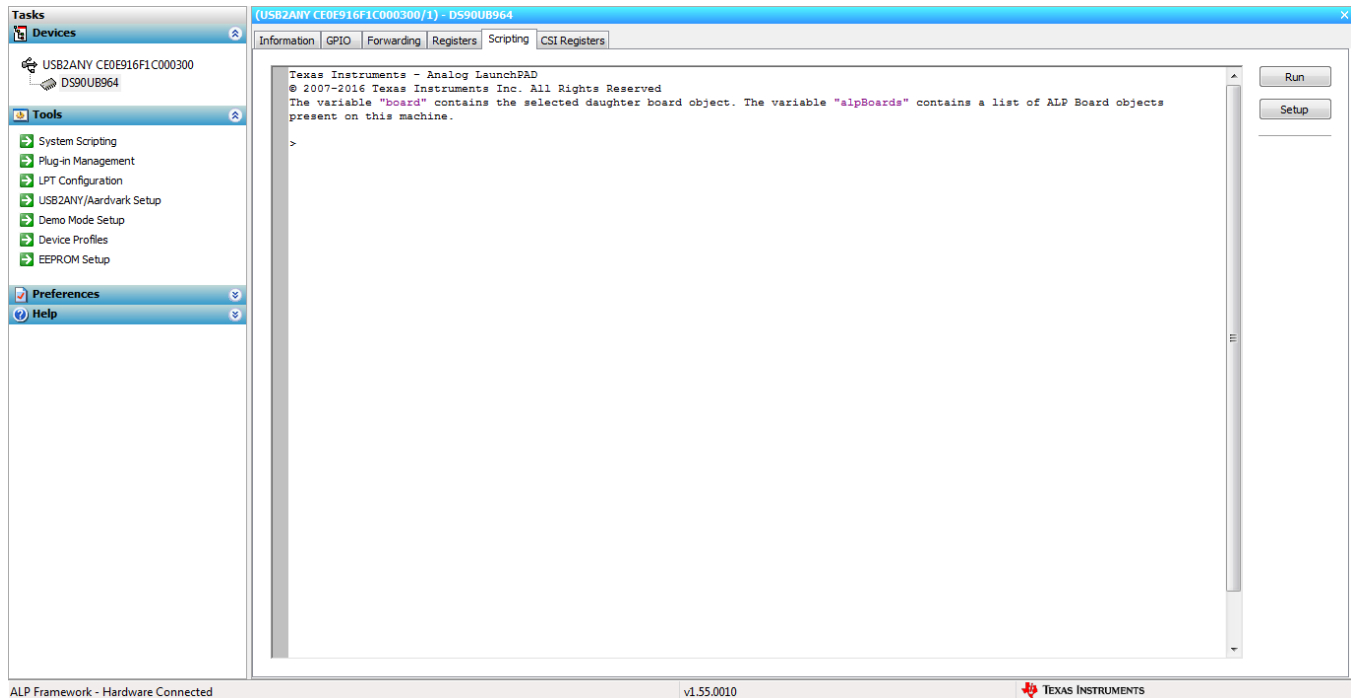

Figure 1-12. ALP Scripting Tab

The script window provides a full Python scripting environment which can be for running scripts and interacting with the device in an interactive or automated fashion.

WARNING

Directly interacting with devices either through register modifications or calling device support library functions can effect the performance and/or functionality of the user interface and may even crash the ALP Framework application.

1.10.10 Sample ALP Python Script

1.10.10.1 Initialization

```
# 964_RX0_init_CSI0.py

# board.devAddr = 0x7a

# To configure GPIO0 to bring out Lock for Port0,
print "configure GPIO0 to bring out Lock for Port0"
board.WriteReg(0x10,0x81)
time.sleep(0.1)

# To configure GPIO1 to bring out Lock for Port1,
print "configure GPIO1 to bring out Lock for Port1"
board.WriteReg(0x11,0x85)
time.sleep(0.1)

# To configure GPIO2 to bring out Lock for Port2,
```

```

print "configure GPIO2 to bring out Lock for Port2"
board.WriteReg(0x12,0x89)
time.sleep(0.1)

# To configure GPIO3 to bring out Lock for Port3,
print "configure GPIO3 to bring out Lock for Port3"
board.WriteReg(0x13,0x8D)
time.sleep(0.1)

print "CSI_PORT_SEL"
board.WriteReg(0x32,0x01) # CSI0 select
time.sleep(0.1)

print "CSI_PLL_CTL"
board.WriteReg(0x1f,0x02) # CSI0 800mbps
time.sleep(0.1)

print "CSI_EN"
board.WriteReg(0x33,0x1) # CSI_EN & CSI0 4L
time.sleep(0.1)

print "FWD_PORT"
board.WriteReg(0x20,0xe0) # forwarding of RX 0 to CSI0
time.sleep(0.1)

print "FPD3_PORT_SEL"
board.WriteReg(0x4c,0x01) # RX_PORT0
time.sleep(0.1)

print "enable pass throu"
board.WriteReg(0x58,0x58) # enable pass throu
time.sleep(0.1)

board.WriteReg(0x5c,0x18) #
print "SER_ALIAS_ID 0x5c value ", hex(board.ReadReg(0x5c))
time.sleep(0.1)

board.WriteReg(0x5d,0x60) #
print "SlaveID[0] 0x5d value ", hex(board.ReadReg(0x5d))
time.sleep(0.1)

board.WriteReg(0x65,0x60) #
print "SlaveAlias[0] 0x65 value ", hex(board.ReadReg(0x65))
time.sleep(0.1)

print "FV_POLARITY"
board.WriteReg(0x7c,0x01) # FV active low
time.sleep(0.1)

print "YUV422 DT"
board.WriteReg(0x70,0x1f) # VC0 and CSI0 datatype 0x1f yuv422_10b
time.sleep(0.1)

print "FPD_MODE"
board.WriteReg(0x6d,0x7f) # 913A 10-bit mode
time.sleep(0.1)

#####
# 964_RX1_init_CSI0.py

print "CSI_PORT_SEL"
board.WriteReg(0x32,0x01) # CSI0 select
time.sleep(0.1)

print "CSI_PLL_CTL"
board.WriteReg(0x1f,0x02) # CSI0 800mbps

```

```

time.sleep(0.1)

print "CSI_EN"
board.WriteReg(0x33,0x1) # CSI_EN & CSI0 4L
time.sleep(0.1)

print "FWD_PORT"
board.WriteReg(0x20,0xd0) # forwarding of RX 1 to CSI0
time.sleep(0.1)

print "FPD3_PORT_SEL"
board.WriteReg(0x4c,0x12) # RX_PORT1
time.sleep(0.1)

print "enable pass throu"
board.WriteReg(0x58,0x58) # enable pass throu
time.sleep(0.1)

board.WriteReg(0x5c,0x1a) #
print "SER_ALIAS_ID 0x5c value ", hex(board.ReadReg(0x5c))
time.sleep(0.1)

board.WriteReg(0x5d,0x60) #
print "SlaveID[0] 0x5d value ", hex(board.ReadReg(0x5d))
time.sleep(0.1)

board.WriteReg(0x65,0x62) #
print "SlaveAlias[0] 0x65 value ", hex(board.ReadReg(0x65))
time.sleep(0.1)

print "FV_POLARITY"
board.WriteReg(0x7c,0x01) # FV active low
time.sleep(0.1)

print "YUV422 DT"
board.WriteReg(0x70,0x5f) # VC1 and CSI0 datatype 0x1f yuv422_10b
time.sleep(0.1)

print "FPD_MODE"
board.WriteReg(0x6d,0x7f) # 913A 10-bit mode
time.sleep(0.1)

#####
# 964_RX2_init_CSI0.py

print "CSI_PORT_SEL"
board.WriteReg(0x32,0x01) # CSI0 select
time.sleep(0.1)

print "CSI_PLL_CTL"
board.WriteReg(0x1f,0x02) # CSI0 800mbps
time.sleep(0.1)

print "CSI_EN"
board.WriteReg(0x33,0x1) # CSI_EN & CSI0 4L
time.sleep(0.1)

print "FWD_PORT"
board.WriteReg(0x20,0xb0) # forwarding of RX 2 to CSI0
time.sleep(0.1)

print "FPD3_PORT_SEL"
board.WriteReg(0x4c,0x24) # RX_PORT2
time.sleep(0.1)

print "enable pass throu"

```



```

board.WriteReg(0x58,0x58) # enable pass throu
time.sleep(0.1)

board.WriteReg(0x5c,0x1c) #
print "SER_ALIAS_ID 0x5c value ", hex(board.ReadReg(0x5c))
time.sleep(0.1)

board.WriteReg(0x5d,0x60) #
print "SlaveID[0] 0x5d value ", hex(board.ReadReg(0x5d))
time.sleep(0.1)

board.WriteReg(0x65,0x66) #
print "SlaveAlias[0] 0x65 value ", hex(board.ReadReg(0x65))
time.sleep(0.1)

print "FV_POLARITY"
board.WriteReg(0x7c,0x01) # FV active low
time.sleep(0.1)

print "YUV422 DT"
board.WriteReg(0x70,0x9f) # VC2 and CSI0 datatype 0x1f yuv422_10b
time.sleep(0.1)

print "FPD_MODE"
board.WriteReg(0x6d,0x7f) # 913A 10-bit mode
time.sleep(0.1)

#####
# 964_RX3_init_CSI0.py

print "CSI_PORT_SEL"
board.WriteReg(0x32,0x01) # CSI0 select
time.sleep(0.1)

print "CSI_PLL_CTL"
board.WriteReg(0x1f,0x02) # CSI0 800mbps
time.sleep(0.1)

print "CSI_EN"
board.WriteReg(0x33,0x1) # CSI_EN & CSI0 4L
time.sleep(0.1)

print "FWD_PORT"
board.WriteReg(0x20,0x70) # forwarding of RX 3 to CSI0
time.sleep(0.1)

print "FPD3_PORT_SEL"
board.WriteReg(0x4c,0x38) # RX_PORT3
time.sleep(0.1)

print "enable pass throu"
board.WriteReg(0x58,0x58) # enable pass throu
time.sleep(0.1)

board.WriteReg(0x5c,0x1e) #
print "SER_ALIAS_ID 0x5c value ", hex(board.ReadReg(0x5c))
time.sleep(0.1)

board.WriteReg(0x5d,0x60) #
print "SlaveID[0] 0x5d value ", hex(board.ReadReg(0x5d))
time.sleep(0.1)

board.WriteReg(0x65,0x68) #
print "SlaveAlias[0] 0x65 value ", hex(board.ReadReg(0x65))
time.sleep(0.1)

```

```
print "FV_POLARITY"
board.WriteReg(0x7c,0x01) #
time.sleep(0.1)

print "YUV422 DT"
board.WriteReg(0x70,0xdf) # VC3 and CSI0 datatype 0x1f yuv422_10b
time.sleep(0.1)

print "FPD_MODE"
board.WriteReg(0x6d,0x7f) # 913A 10-bit mode
time.sleep(0.1)

#####
```

1.11 Troubleshooting ALP Software

1.11.1 ALP Loads the Incorrect Profile

If ALP opens with the incorrect profile loaded the correct profile can be loaded from the USB2ANY/Aardvark Setup found under the tools menu.

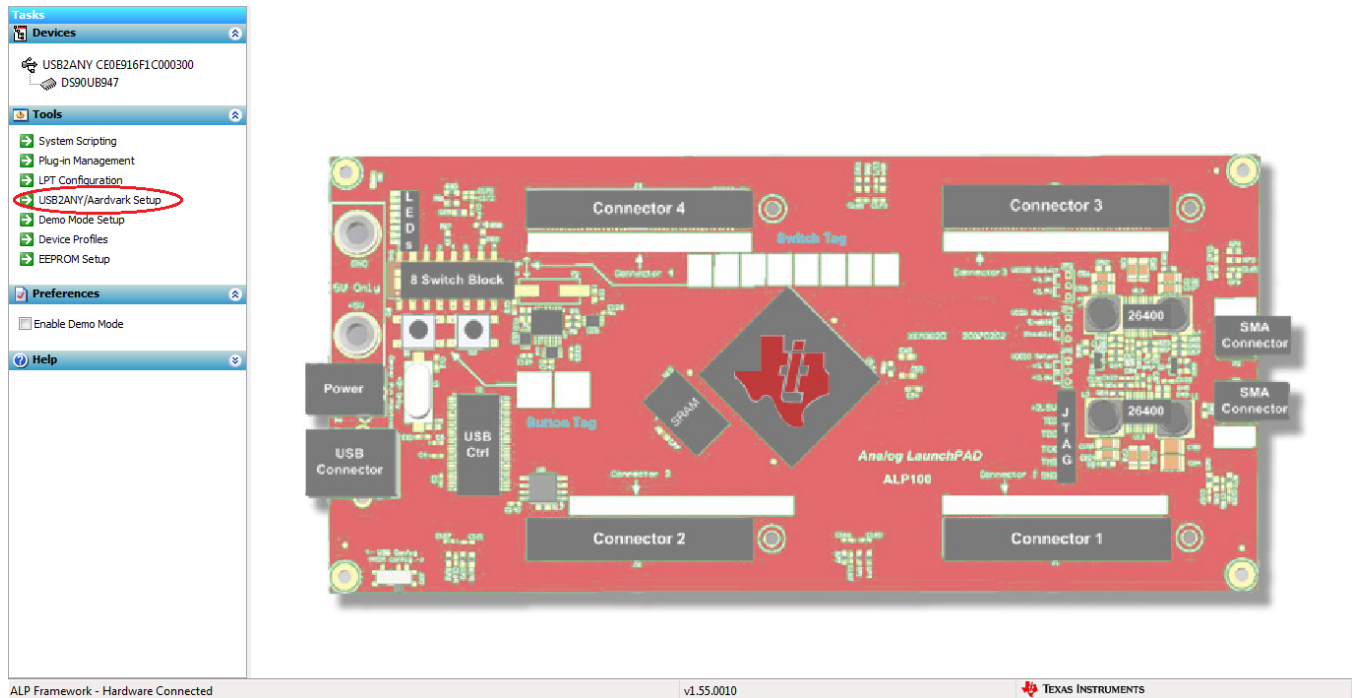

Figure 1-13. USB2ANY Setup

Highlight the incorrect profile in the Defined ALP Devices list and press the remove button.

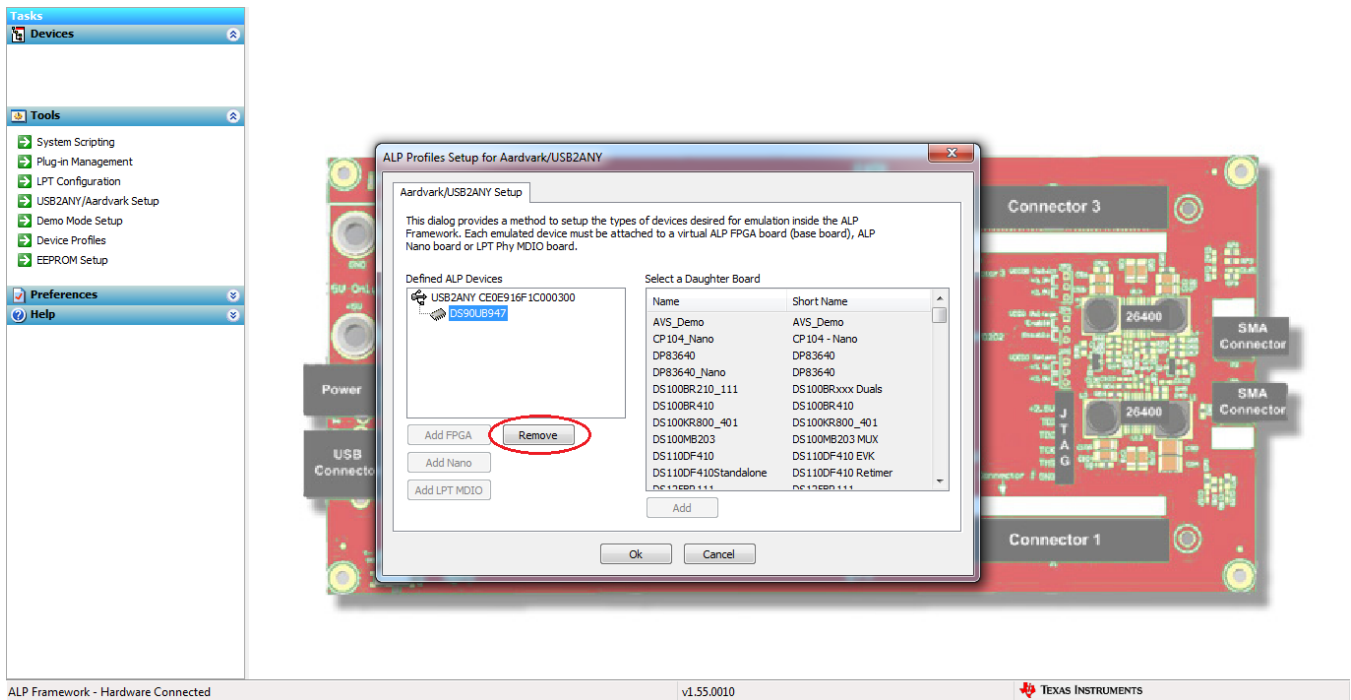

Figure 1-14. Remove Incorrect Profile

Find the correct profile under the Select a Daughter Board list, highlight the profile and press Add.

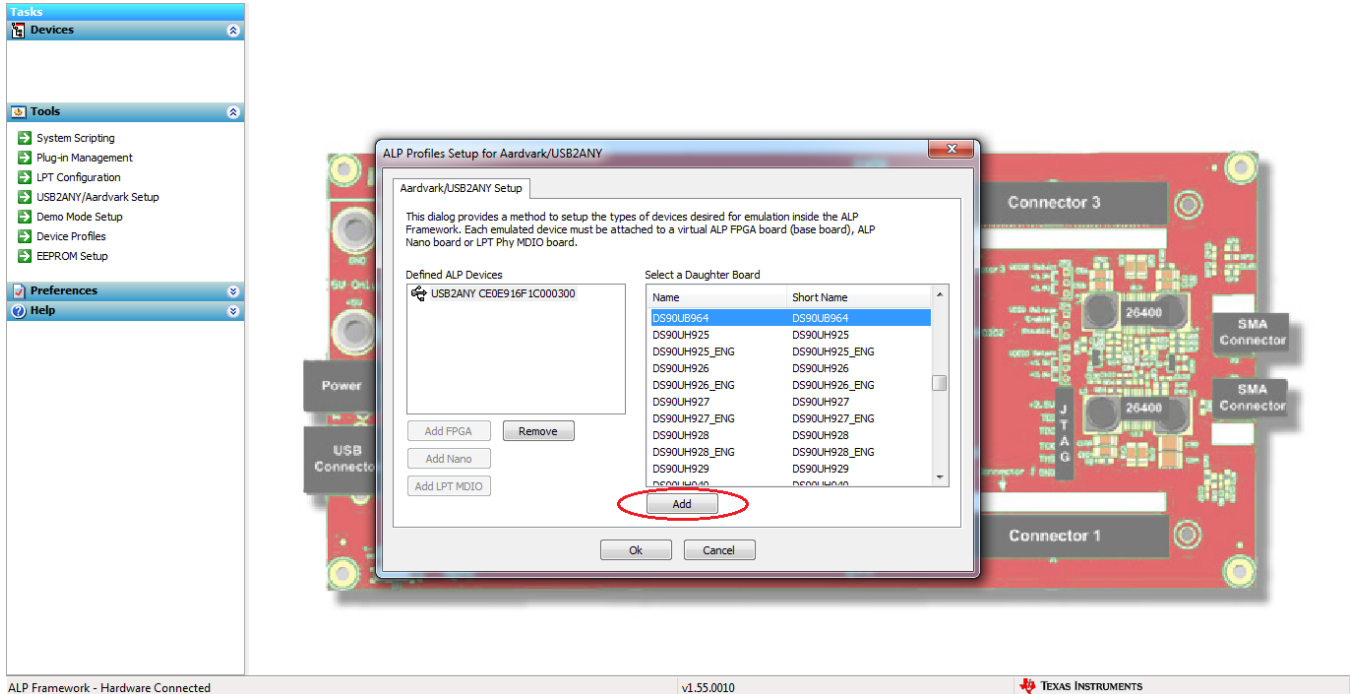

Figure 1-15. Add Correct Profile

Select Ok and the correct profile should now be loaded.

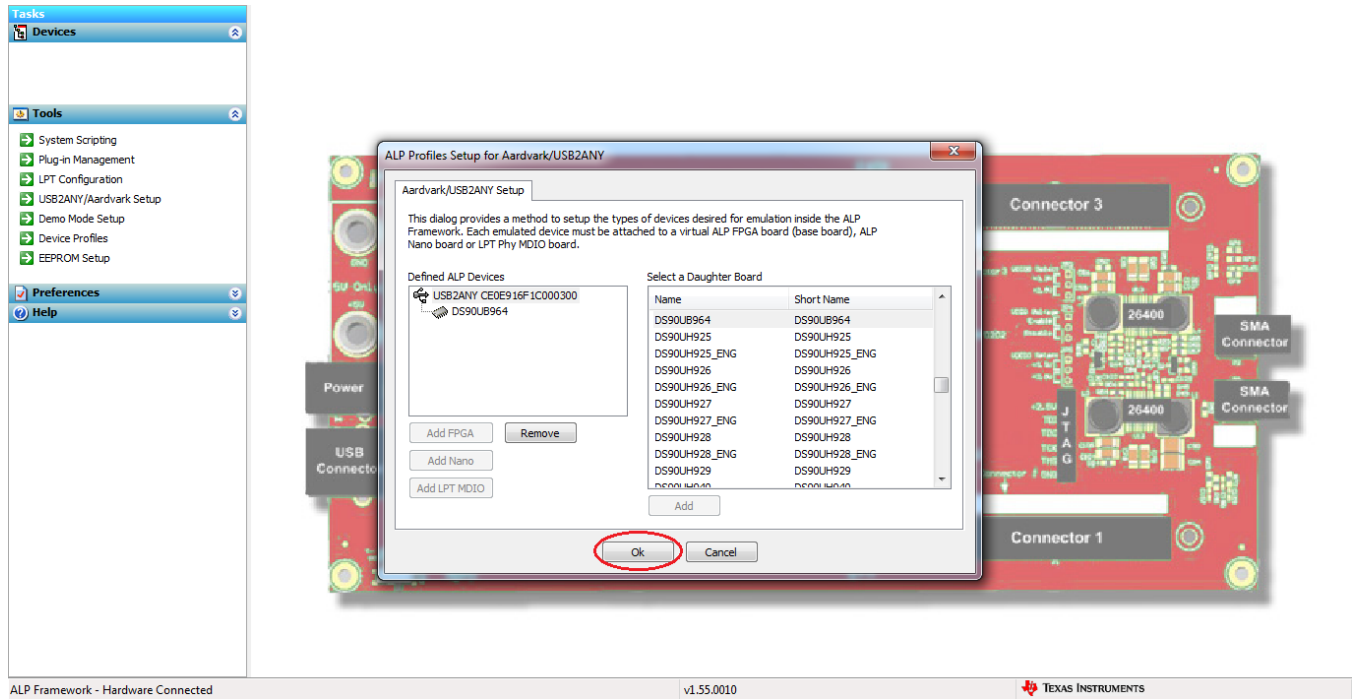

Figure 1-16. Finish Setup

1.11.2 ALP does not detect the EVM

If the following window opens after starting the ALP software, double check the hardware setup.

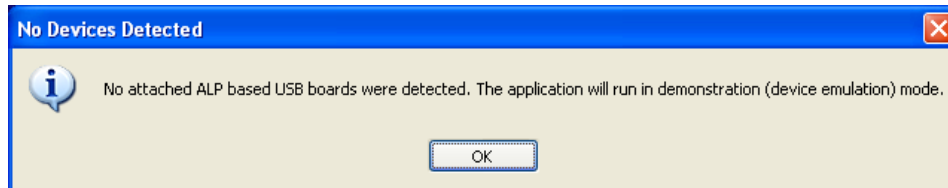

Figure 1-17. ALP No Devices Error

It may also be that the USB2ANY driver is not installed. Check the device manager. There should be a “HID-compliant device” under the “Human Interface Devices” as shown below.

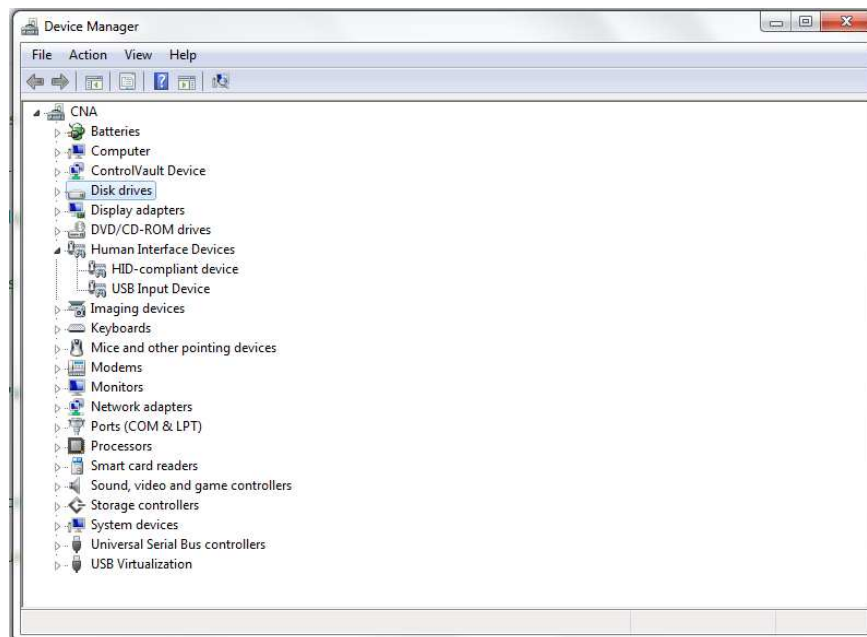

Figure 1-18. Windows 7, ALP USB2ANY Driver

The software should start with only “DS90UB96X” in the “Devices” pull down menu. If there are more devices then the software is most likely in demo mode. When the ALP is operating in demo mode there is a “(Demo Mode)” indication in the lower left of the application status bar as shown below.

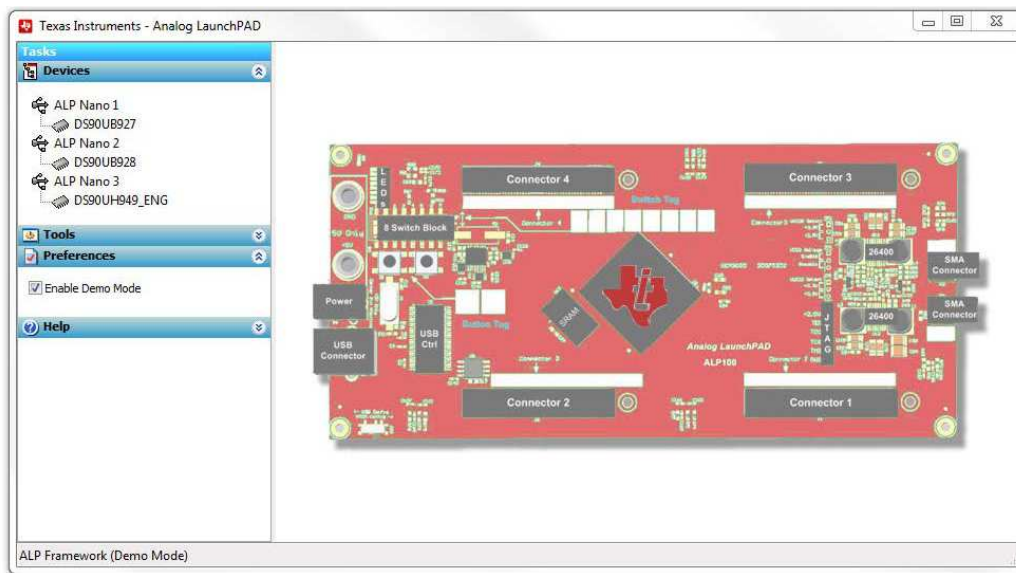

Figure 1-19. ALP in Demo Mode

Disable the demo mode by selecting the “Preferences” pull down menu and un-checking “Enable Demo Mode”.

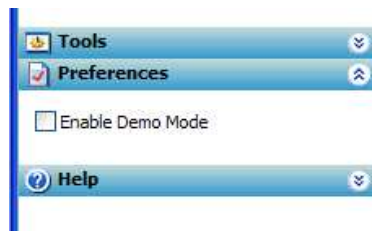

Figure 1-20. ALP Preferences Menu

After demo mode is disabled, the ALP software will poll the ALP hardware. The ALP software will update and have only “DS90UB96X” under the “Devices” pull down menu.

1.12 Typical Connection and Test Equipment

The following is a list of typical test equipment that may be used to monitor the MIPI CSI-2 signals from the DS90UB96X-Q1:

1. Logic Analyzer
2. Any SCOPE with a bandwidth of at least 4 GHz for observing differential signals.
3. UNH-IOL MIPI D-PHY Reference Termination Board (RTB)
4. UNH-IOL MIPI D-PHY/CSI/DSI Probing Board
5. UNH-IOL CSIGUI Tool

1.13 Termination Device

A termination device is required in order to properly monitor and measure the transmission of the MIPI DPHY signals. The termination device should support the change of signals as it switches between LP and HS modes. This can be provided by either a CSI-2 receiver or a dedicated dynamic termination board. The recommended termination board is the UNH-IOL MIPI D-PHY Reference Termination Board (RTB).

1.14 Typical Test Setup

Figure 1-21 and Figure 1-22 illustrate the typical test setups used to measure and evaluate DS90UB96X-Q1.

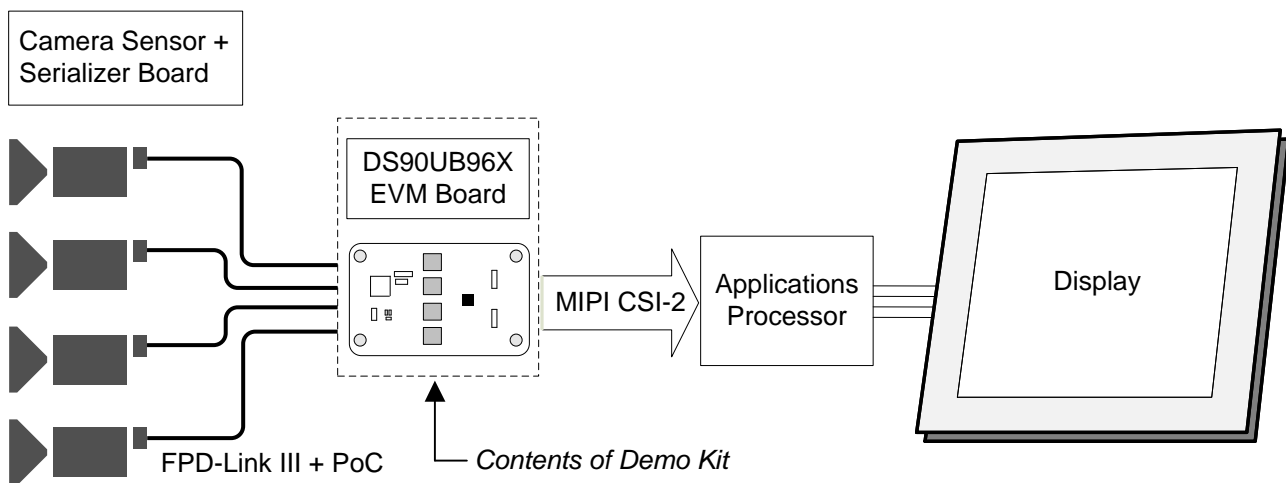

Figure 1-21. Typical Test Setup for Application

The picture below shows a typical test set up using a video generator and logic analyzer.

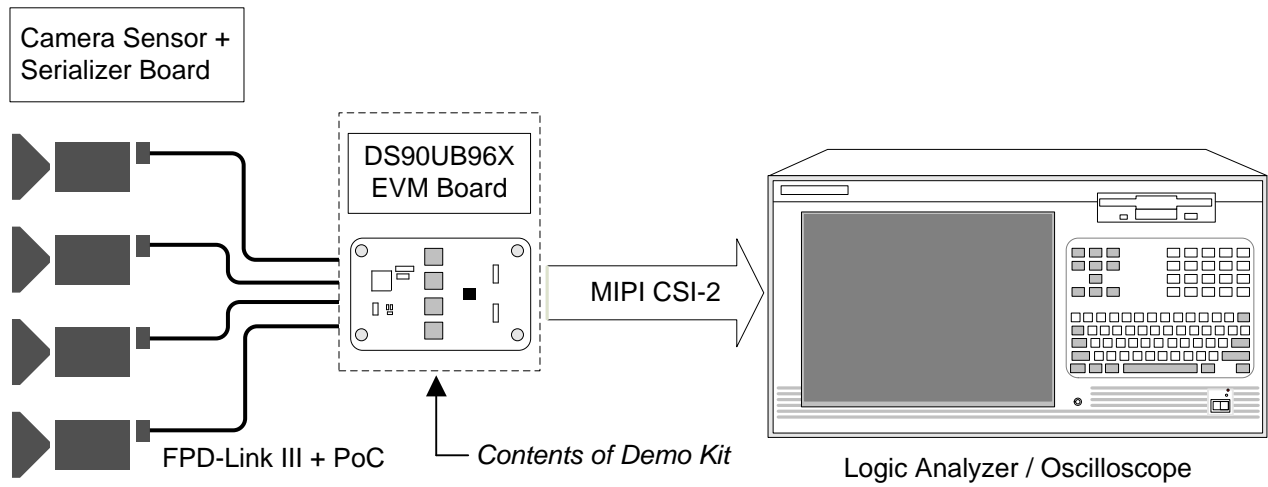

Figure 1-22. Typical Test Setup for Evaluation

1.15 Equipment References

NOTE: Please note that the following references are supplied only as a courtesy to our valued customers. It is not intended to be an endorsement of any particular equipment or supplier.

Logic Analyzer:

Keysight Technologies

www.keysight.com

MIPI Test Fixtures:

University of New Hampshire InterOperability Laboratory (UNH-IOL)

www.iol.unh.edu/services/testing/mipi/fixtures.php

Aardvark I²C/SPI Host Adapter Part Number: TP240141

www.totalphase.com/products/aardvark_i2cspi

1.16 Cable References

FAKRA coaxial cable:

www.leoni-automotive-cables.com

Rosenberger FAKRA connector:

<http://www.rosenberger.com/en/products/automotive/fakra.php>

1.17 Bill of Materials

Table 1-18. BOM for DS90UB96X-Q1EVM Assembly Variant SV601176-001

Item	Qty	Designator	Part Number	Manufacturer	Description
1	1	PCB	SV601176	Any	Printed Circuit Board
2	8	C1, C6, C12, C20, C26, C31, C42, C43	CL21A106KAFN3NE	Samsung Electro-Mechanics	CAP, CERM, 10 μ F, 25 V, +/- 10%, X5R, 0805
3	8	C3, C8, C14, C22, C28, C33, C44, C114	C1005JB1V105K050BC	TDK	CAP, CERM, 1 μ F, 35 V, +/- 10%, JB, 0402
4	15	C4, C9, C15, C23, C29, C34, C45, C47, C53, C63, C64, C80, C81, C94, C95	CGA2B3X7R1H104K050 BB	TDK	CAP, CERM, 0.1 μ F, 50 V, +/- 10%, X7R, AEC-Q200 Grade 1, 0402
5	16	C5, C10, C11, C16, C17, C18, C19, C24, C25, C30, C35, C36, C41, C46, C52, C58	GCM155R71H103KA55D	MuRata	CAP, CERM, 0.01 μ F, 50V, +/-10%, C0G/NP0, 0402
6	5	C37, C50, C59, C132, C133	0603YC104JAT2A	AVX	CAP, CERM, 0.1 μ F, 16V, +/-5%, X7R, 0603
7	1	C38	0805YD225KAT2A	AVX	CAP, CERM, 2.2 μ F, 16V, +/-10%, X5R, 0805
8	2	C39, C55	06035A221FAT2A	AVX	CAP, CERM, 220pF, 50V, +/-1%, C0G/NP0, 0603
9	1	C40	C1608X7R1H103K080AA	TDK	CAP, CERM, 0.01 μ F, 50 V, +/- 10%, X7R, 0603
10	5	C48, C104, C112, C119, C120	293D226X0025D2TE3	Vishay-Sprague	CAP, TA, 22 μ F, 25V, +/-20%, 0.7 ohm, SMD
11	1	C49	GRM21BR71C105KA01L	MuRata	CAP, CERM, 1 μ F, 16 V, +/- 10%, X7R, 0805
12	2	C51, C54	GRM1885C2A300JA01D	MuRata	CAP, CERM, 30pF, 100V, +/-5%, C0G/NP0, 0603
13	1	C56	GRM188R71A474KA61D	MuRata	CAP, CERM, 0.47 μ F, 10V, +/-10%, X7R, 0603
14	1	C57	C0603X222K5RACTU	Kemet	CAP, CERM, 2200pF, 50V, +/-10%, X7R, 0603
15	1	C60	06031C103KAT2A	AVX	CAP, CERM, 0.01 μ F, 100 V, +/- 10%, X7R, 0603
16	15	C61, C62, C101, C103, C105, C109, C115, C116, C118, C125, C126, C129, C130, C134, C135	GRM155R71C104KA88D	MuRata	CAP, CERM, 0.1 μ F, 16V, +/-10%, X7R, 0402
17	5	C65, C108, C117, C127, C131	GRM21BR71A106KE51L	MuRata	CAP, CERM, 10 μ F, 10V, +/-10%, X7R, 0805
18	4	C67, C68, C69, C70	GRM1555C1E4R7CA01D	MuRata	CAP, CERM, 4.7pF, 25V, +/-5%, C0G/NP0, 0402
19	8	C72, C74, C76, C78, C86, C88, C90, C92	C1005X7R1H104K050BB	TDK	CAP, CERM, 0.1 μ F, 50 V, +/- 10%, X7R, 0402
20	8	C73, C75, C77, C79, C87, C89, C91, C93	GRM188R61E475KE11D	Murata Electronics North America	CAP CER 4.7UF 25V 10% X5R 0603
21	4	C82, C83, C96, C97	C1005X7R1H473K050BB	TDK	CAP, CERM, 0.047 μ F, 50 V, +/- 10%, X7R, 0402
22	4	C84, C85, C98, C99	GRM1555C1H241JA01D	MuRata	CAP, CERM, 240 pF, 50 V, +/- 5%, C0G/NP0, 0402
23	1	C100	GRM1555C1H100JA01D	MuRata	CAP, CERM, 10pF, 50V, +/-5%, C0G/NP0, 0402
24	2	C102, C111	C1608X7R1C105K	TDK	CAP, CERM, 1 μ F, 16V, +/-10%, X7R, 0603

Table 1-18. BOM for DS90UB96X-Q1EVM Assembly Variant SV601176-001 (continued)

Item	Qty	Designator	Part Number	Manufacturer	Description
25	1	C106	T495D107M016ATE100	Kemet	CAP, TA, 100uF, 16V, +/-20%, 0.1 ohm, SMD
26	1	C107	GRM32ER61C476ME15L	MuRata	CAP, CERM, 47uF, 16V, +/-20%, X5R, 1210
27	1	C110	GRM155R71H332KA01D	MuRata	CAP, CERM, 3300pF, 50V, +/-10%, X7R, 0402
28	4	C113, C123, C124, C128	GRM21BR71C475KA73L	MuRata	CAP, CERM, 4.7uF, 16V, +/-10%, X7R, 0805
29	1	C121	293D225X9025A2TE3	Vishay-Sprague	CAP, TA, 2.2uF, 25V, +/-10%, 6.3 ohm, SMD
30	1	C122	06031C103JAT2A	AVX	CAP, CERM, 0.01uF, 100V, +/-5%, X7R, 0603
31	4	C162, C163, C164, C165	08051C472KAT2A	AVX	CAP, CERM, 4700 pF, 100 V, +/- 10%, X7R, 0805
32	4	CN1, CN2, CN3, CN4	59S10H-40ML5-Z	Rosenberger	Connector, HF, 50 Ohm, TH
33	10	D1, D2, D3, D4, D5, D6, D7, D8, D9, D16	150060VS75000	Würth Elektronik eiSos	LED, Green, SMD
34	1	D10	1N5819HW-7-F	Diodes Inc.	Diode, Schottky, 40V, 1A, SOD-123
35	3	D11, D12, D14	150060SS75000	Würth Elektronik eiSos	LED, Super Red, SMD
36	1	D13	LTST-C190KFKT	Lite-On	LED, Orange, SMD
37	1	D15	1SMB5922BT3G	ON Semiconductor	Diode, Zener, 7.5 V, 550 mW, SMB
38	1	F1	0440002.WR	Littelfuse	Fuse, 2 A, 32 V, SMD
39	1	FB1	BK1608HS600-T	Taiyo Yuden	Ferrite Bead, 60 ohm @ 100 MHz, 0.8 A, 0603
40	8	J1, J12, J14, J16, J19, J28, J29, J30	TSW-103-07-G-S	Samtec, Inc.	Header, TH, 100mil, 3x1, Gold plated, 230 mil above insulator
41	1	J2	TSW-108-07-G-D	Samtec	Header, 100mil, 8x2, Gold, TH
42	17	J3, J8, J9, J10, J11, J13, J15, J17, J18, J20, J21, J22, J23, J25, J26, J27, J34	5-146261-1	TE Connectivity	Header, 100mil, 2x1, Gold plated, TH
43	2	J4, J5	0022112042	Molex	Header, 100mil, 4x1, White, TH
44	2	J6, J7	QSH-020-01-H-D-DP-A	Samtec	Receptacle, Differential, 0.5mm, 10 pair x2, Gold, SMT
45	1	J24	PJ-102A	CUI Inc.	Connector, DC Jack 2.1X5.5 mm, TH
46	1	J32	TSW-104-07-G-D	Samtec	Header, 100mil, 4x2, Gold, TH
47	1	J33	TSW-104-07-G-S	Samtec	Header, 100mil, 4x1, Gold, TH
48	1	J35	TSW-102-07-G-D	Samtec	Header, 100mil, 2x2, Gold, TH
49	1	J36	1734035-2	TE Connectivity	Connector, Receptacle, Mini-USB Type B, R/A, Top Mount SMT
50	7	L1, L2, L3, L4, L5, L6, L8	BLM18SG121TN1D	MuRata	Ferrite Bead, 120 ohm @ 100 MHz, 3 A, 0603
51	4	L11, L12, L21, L22	BLM18AG102SN1D	MuRata	Ferrite Bead, 1000 ohm @ 100 MHz, 0.4 A, 0603

Table 1-18. BOM for DS90UB96X-Q1EVM Assembly Variant SV601176-001 (continued)

Item	Qty	Designator	Part Number	Manufacturer	Description
52	4	L13, L15, L23, L25	1008PS-472KLB	Coilcraft	Inductor, Shielded, Ferrite, 4.7 μ H, 0.7 A, 0.35 ohm, SMD
53	4	L14, L16, L24, L26	MSS7341T-104MLB	Coilcraft	Inductor, Shielded Drum Core, Ferrite, 100 μ H, 0.7 A, 0.28 ohm, SMD
54	4	L17, L18, L27, L28	BLM15HD182SN1D	MuRata	Ferrite Bead, 1800 ohm @ 100 MHz, 0.2 A, 0402
55	1	L31	7440650047	Würth Elektronik	Inductor, Shielded Drum Core, Ferrite, 4.7 μ H, 4.2 A, 0.02 ohm, SMD
56	1	LBL1	THT-13-457-10	Brady	Thermal Transfer Printable Labels, 1.250" W x 0.250" H - 10,000 per roll
57	2	Q1, Q2	BSS138	Fairchild Semiconductor	MOSFET, N-CH, 50 V, 0.22 A, SOT-23
58	14	R1, R3, R11, R25, R26, R27, R28, R34, R36, R41, R110, R119, R128, R155	ERJ-2GE0R00X	Panasonic	RES, 0 ohm, 5%, 0.063W, 0402
59	1	R2	CRCW0402100RFKED	Vishay-Dale	RES, 100 ohm, 1%, 0.063W, 0402
60	1	R4	CRCW0402470RJNED	Vishay-Dale	RES, 470 ohm, 5%, 0.063W, 0402
61	3	R5, R16, R17	CRCW040210K0JNED	Vishay-Dale	RES, 10k ohm, 5%, 0.063W, 0402
62	5	R6, R97, R105, R118, R122	CRCW0402100KJNED	Vishay-Dale	RES, 100k ohm, 5%, 0.063W, 0402
63	1	R7	CRCW040282K5FKED	Vishay-Dale	RES, 82.5 k, 1%, 0.063 W, 0402
64	1	R8	CRCW040268K1FKED	Vishay-Dale	RES, 68.1 k, 1%, 0.063 W, 0402
65	1	R9	CRCW040256K2FKED	Vishay-Dale	RES, 56.2 k, 1%, 0.063 W, 0402
66	1	R10	CRCW040213K3FKED	Vishay-Dale	RES, 13.3 k, 1%, 0.063 W, 0402
67	1	R13	CRCW0402102KFKED	Vishay-Dale	RES, 102 k, 1%, 0.063 W, 0402
68	1	R14	CRCW0402137KFKED	Vishay-Dale	RES, 137 k, 1%, 0.063 W, 0402
69	1	R15	CRCW0402210KFKED	Vishay-Dale	RES, 210 k, 1%, 0.063 W, 0402
70	7	R20, R21, R22, R23, R76, R102, R115	CRCW04024K70JNED	Vishay-Dale	RES, 4.7k ohm, 5%, 0.063W, 0402
71	1	R29	CRCW040240K2FKED	Vishay-Dale	RES, 40.2 k, 1%, 0.063 W, 0402
72	15	R58, R59, R72, R73, R88, R90, R96, R99, R106, R108, R109, R112, R120, R121, R129	CRCW06030000Z0EA	Vishay-Dale	RES, 0 ohm, 5%, 0.1W, 0603
73	11	R60, R61, R62, R63, R64, R65, R66, R67, R125, R126, R127	CRCW0402220RJNED	Vishay-Dale	RES, 220, 5%, 0.063 W, 0402
74	8	R68, R69, R70, R71, R80, R81, R82, R83	ERJ-3EKF1001V	Panasonic	RES, 1.00 k, 1%, 0.1 W, 0603
75	4	R74, R75, R84, R85	CRCW040257R6FKED	Vishay-Dale	RES, 57.6, 1%, 0.063 W, 0402

Table 1-18. BOM for DS90UB96X-Q1EVM Assembly Variant SV601176-001 (continued)

Item	Qty	Designator	Part Number	Manufacturer	Description
76	2	R77, R147	CRCW040233R0JNED	Vishay-Dale	RES, 33 ohm, 5%, 0.063W, 0402
77	4	R78, R79, R86, R87	CRCW0402200RJNED	Vishay-Dale	RES, 200, 5%, 0.063 W, 0402
78	6	R89, R95, R98, R103, R107, R154	CRCW040210K0FKED	Vishay-Dale	RES, 10.0k ohm, 1%, 0.063W, 0402
79	3	R91, R100, R111	CRCW040229K4FKED	Vishay-Dale	RES, 29.4 k, 1%, 0.063 W, 0402
80	1	R92	CRCW0402124KFKED	Vishay-Dale	RES, 124k ohm, 1%, 0.063W, 0402
81	1	R93	CRCW040222K1FKED	Vishay-Dale	RES, 22.1k ohm, 1%, 0.063W, 0402
82	4	R94, R101, R104, R114	CRCW04023K24FKED	Vishay-Dale	RES, 3.24k ohm, 1%, 0.063W, 0402
83	1	R113	CRCW04021K87FKED	Vishay-Dale	RES, 1.87k ohm, 1%, 0.063W, 0402
84	1	R116	CRCW04024K99FKED	Vishay-Dale	RES, 4.99k ohm, 1%, 0.063W, 0402
85	2	R123, R124	CRCW04022K40JNED	Vishay-Dale	RES, 2.4 k, 5%, 0.063 W, 0402
86	1	R148	CRCW04021K50JNED	Vishay-Dale	RES, 1.5k ohm, 5%, 0.063W, 0402
87	2	R149, R153	CRCW040233K0JNED	Vishay-Dale	RES, 33k ohm, 5%, 0.063W, 0402
88	1	R150	CRCW06031M20JNEA	Vishay-Dale	RES, 1.2Meg ohm, 5%, 0.1W, 0603
89	1	R152	CRCW0603200RFKEA	Vishay-Dale	RES, 200 ohm, 1%, 0.1W, 0603
90	1	S1	219-4LPST	CTS Electrocomponents	Switch, SPST 4 Pos, Top Actuated, SMT
91	2	S2, S3	KSR221GLFS	C and K Components	Switch, Normally open, 2.3N force, 200k operations, SMD
92	15	SH-J1, SH-J2, SH-J3, SH-J4, SH-J5, SH-J6, SH-J7, SH-J8, SH-J9, SH-J10, SH-J11, SH-J12, SH-J13, SH-J14, SH-J15	SPC02SYAN	Sullins Connector Solutions	Shunt, 100mil, Flash Gold, Black
93	1	SW1	219-2LPST	CTS Electrocomponents	Switch, Slide, SPST 2 poles, SMT
94	1	T1	ACM9070-701-2PL	TDK	Common Mode Filter for Power Line
95	1	U1	DS90UB964TRGCRQ1	Texas Instruments	FPD-Link III Camera Hub Deserializer, RGC0064G
96	3	U2, U4, U6	LM2941LD/NOPB	Texas Instruments	1A Low Dropout Adjustable Regulator, 8-pin LLP, Pb-Free
97	1	U3	TPS54225PWPR	Texas Instruments	4.5V to 18V Input, 2-A Synchronous Step-Down SWIFT™ Converter, PWP0014E
98	1	U5	TPS74801TDRCRQ1	Texas Instruments	Single Output LDO, 1.5 A, Adjustable 0.8 to 3.6 V Output, 0.8 to 5.5 V Input, with Programmable Soft Start, 10-pin SON (DRC), -40 to 105 degC, Green (RoHS & no Sb/Br)

Table 1-18. BOM for DS90UB96X-Q1EVM Assembly Variant SV601176-001 (continued)

Item	Qty	Designator	Part Number	Manufacturer	Description
99	1	U7	TPS767D318PWP	Texas Instruments	Dual Output LDO, 1 A, Fixed 1.8, 3.3 V Output, 2.7 to 10 V Input, 28-pin HTSSOP (PWP), -40 to 125 degC, Green (RoHS & no Sb/Br)
100	1	U8	TPD4E004DRYR	Texas Instruments	ESD-Protection Array for High-Speed Data Interfaces, 4 Channels, -40 to +85 degC, 6-pin SON (DRY), Green (RoHS & no Sb/Br)
101	1	U9	TPS73533DRBR	Texas Instruments	500mA, Low Quiescent Current, Ultra-Low Noise, High PSRR Low-Dropout Linear Regulator, DRB0008A
102	1	U10	MSP430F5529IPN	Texas Instruments	25 MHz Mixed Signal Microcontroller with 128 KB Flash, 8192 B SRAM and 63 GPIOs, -40 to 85 degC, 80-pin QFP (PN), Green (RoHS & no Sb/Br)
103	1	U11	TCA9406DCUR	Texas Instruments	TCA9406 Dual Bidirectional 1-MHz I2C-BUS and SMBus Voltage Level-Translator, 1.65 to 3.6 V, -40 to 85 degC, 8-pin US8 (DCU), Green (RoHS & no Sb/Br)
104	1	Y1	KC5032A25.0000CMGE00	AVX	OSC, 25 MHz, 1.6 to 5.5 V, SMD
105	1	Y2	ABM3-25.000MHZ-D2Y-T	Abracon Corporation	Crystal, 25 MHz, 18 pF, SMD
106	1	Y3	ABM3-24.000MHZ-D2Y-T	Abracon Corporation	Crystal, 24 MHz, 18 pF, SMD
107	0	C2, C7, C13, C21, C27, C32	CL21A106KAFN3NE	Samsung Electro-Mechanics	CAP, CERM, 10 µF, 25 V, +/- 10%, X5R, 0805
108	0	C66, C71	GRM1555C1H270JA01D	MuRata	CAP, CERM, 27 pF, 50 V, +/- 5%, C0G/NP0, 0402
109	0	J31	QTH-020-04-L-D-DP-A	Samtec	Header(shrouded), 0.5mm, 10 pair x 2, Gold, SMT
110	0	J37	TSW-104-07-G-D	Samtec	Header, 100mil, 4x2, Gold, TH
111	0	J38	TSW-104-07-G-S	Samtec	Header, 100mil, 4x1, Gold, TH
112	0	J39	TSW-102-07-G-D	Samtec	Header, 100mil, 2x2, Gold, TH
113	0	L19, L20, L29, L30	DLW21SN900HQ2L	MuRata	Coupled inductor, 0.28 A, 0.41 ohm, +/- 25%, SMD
114	0	R12, R18, R19, R31, R32, R33, R35, R37, R38, R39, R40, R43, R44, R45, R47, R48, R49, R50, R51, R52, R53, R54, R55, R56, R57, R146, R151	ERJ-2GE0R00X	Panasonic	RES, 0 ohm, 5%, 0.063W, 0402
115	0	R24, R30, R117	CRCW040210K0FKED	Vishay-Dale	RES, 10.0k ohm, 1%, 0.063W, 0402

Table 1-18. BOM for DS90UB96X-Q1EVM Assembly Variant SV601176-001 (continued)

Item	Qty	Designator	Part Number	Manufacturer	Description
116	0	R42, R46	CRCW06030000Z0EA	Vishay-Dale	RES, 0 ohm, 5%, 0.1W, 0603
117	0	R130, R131, R132, R133, R134, R135, R136, R137, R138, R139, R140, R141, R142, R143, R144, R145	ERJ-1GE0R00C	Panasonic	RES, 0, 5%, 0.05 W, 0201

Table 1-19. BOM for DS90UB96X-Q1EVM Assembly Variant SV601176-002

Item	Qty	Designator	Part Number	Manufacturer	Description
1	1	PCB	SV601176	Any	Printed Circuit Board
2	7	C1, C6, C12, C20, C26, C31, C42	CL21A106KAFN3NE	Samsung	CAP, CERM, 10 μ F, 25 V, +/- 10%, X5R, 0805
3	8	C3, C8, C14, C22, C28, C33, C44, C114	C1005JB1V105K050BC	TDK	CAP, CERM, 1 μ F, 35 V, +/- 10%, JB, 0402
4	15	C4, C9, C15, C23, C29, C34, C45, C47, C53, C63, C64, C80, C81, C94, C95	CGA2B3X7R1H104K050B B	TDK	CAP, CERM, 0.1 μ F, 50 V, +/- 10%, X7R, AEC-Q200 Grade 1, 0402
5	16	C5, C10, C11, C16, C17, C18, C19, C24, C25, C30, C35, C36, C41, C46, C52, C58	GCM155R71H103KA55D	MuRata	CAP, CERM, 0.01 μ F, 50V, +/-10%, C0G/NP0, 0402
6	5	C37, C50, C59, C132, C133	0603YC104JAT2A	AVX	CAP, CERM, 0.1 μ F, 16V, +/-5%, X7R, 0603
7	1	C38	0805YD225KAT2A	AVX	CAP, CERM, 2.2 μ F, 16V, +/-10%, X5R, 0805
8	2	C39, C55	06035A221FAT2A	AVX	CAP, CERM, 220pF, 50V, +/-1%, C0G/NP0, 0603
9	1	C40	C1608X7R1H103K080AA	TDK	CAP, CERM, 0.01 μ F, 50 V, +/- 10%, X7R, 0603
10	5	C48, C104, C112, C119, C120	293D226X0025D2TE3	Vishay-Sprague	CAP, TA, 22 μ F, 25V, +/-20%, 0.7 ohm, SMD
11	1	C49	GRM21BR71C105KA01L	MuRata	CAP, CERM, 1 μ F, 16 V, +/- 10%, X7R, 0805
12	2	C51, C54	GRM1885C2A300JA01D	MuRata	CAP, CERM, 30pF, 100V, +/-5%, C0G/NP0, 0603
13	1	C56	GRM188R71A474KA61D	MuRata	CAP, CERM, 0.47 μ F, 10V, +/-10%, X7R, 0603
14	1	C57	C0603X222K5RACTU	Kemet	CAP, CERM, 2200pF, 50V, +/-10%, X7R, 0603
15	1	C60	06031C103KAT2A	AVX	CAP, CERM, 0.01 μ F, 100 V, +/- 10%, X7R, 0603
16	15	C61, C62, C101, C103, C105, C109, C115, C116, C118, C125, C126, C129, C130, C134, C135	GRM155R71C104KA88D	MuRata	CAP, CERM, 0.1 μ F, 16V, +/-10%, X7R, 0402
17	5	C65, C108, C117, C127, C131	GRM21BR71A106KE51L	MuRata	CAP, CERM, 10 μ F, 10V, +/-10%, X7R, 0805
18	4	C67, C68, C69, C70	GRM1555C1E4R7CA01D	MuRata	CAP, CERM, 4.7pF, 25V, +/-5%, C0G/NP0, 0402
19	8	C72, C74, C76, C78, C86, C88, C90, C92	C1005X7R1H104K050BB	TDK	CAP, CERM, 0.1 μ F, 50 V, +/- 10%, X7R, 0402
20	8	C73, C75, C77, C79, C87, C89, C91, C93	GRM188R61E475KE11D	Murata Electronics North America	CAP CER 4.7UF 25V 10% X5R 0603
21	4	C82, C83, C96, C97	C1005X7R1H473K050BB	TDK	CAP, CERM, 0.047 μ F, 50 V, +/- 10%, X7R, 0402
22	4	C84, C85, C98, C99	GRM1555C1H241JA01D	MuRata	CAP, CERM, 240 pF, 50 V, +/- 5%, C0G/NP0, 0402
23	1	C100	GRM1555C1H100JA01D	MuRata	CAP, CERM, 10pF, 50V, +/-5%, C0G/NP0, 0402
24	2	C102, C111	C1608X7R1C105K	TDK	CAP, CERM, 1 μ F, 16V, +/-10%, X7R, 0603
25	1	C106	T495D107M016ATE100	Kemet	CAP, TA, 100 μ F, 16V, +/-20%, 0.1 ohm, SMD
26	1	C107	GRM32ER61C476ME15L	MuRata	CAP, CERM, 47 μ F, 16V, +/-20%, X5R, 1210

Table 1-19. BOM for DS90UB96X-Q1EVM Assembly Variant SV601176-002 (continued)

Item	Qty	Designator	Part Number	Manufacturer	Description
27	1	C110	GRM155R71H332KA01D	MuRata	CAP, CERM, 3300pF, 50V, +/-10%, X7R, 0402
28	4	C113, C123, C124, C128	GRM21BR71C475KA73L	MuRata	CAP, CERM, 4.7uF, 16V, +/-10%, X7R, 0805
29	1	C121	293D225X9025A2TE3	Vishay-Sprague	CAP, TA, 2.2uF, 25V, +/-10%, 6.3 ohm, SMD
30	1	C122	06031C103JAT2A	AVX	CAP, CERM, 0.01uF, 100V, +/-5%, X7R, 0603
31	4	C162, C163, C164, C165	08051C472KAT2A	AVX	CAP, CERM, 4700 pF, 100 V, +/- 10%, X7R, 0805
32	4	CN1, CN2, CN3, CN4	59S10H-40ML5-Z	Rosenberger	Connector, HF, 50 Ohm, TH
33	10	D1, D2, D3, D4, D5, D6, D7, D8, D9, D16	150060VS75000	Würth Elektronik eiSos	LED, Green, SMD
34	1	D10	1N5819HW-7-F	Diodes Inc.	Diode, Schottky, 40V, 1A, SOD-123
35	3	D11, D12, D14	150060SS75000	Würth Elektronik eiSos	LED, Super Red, SMD
36	1	D13	LTST-C190KFKT	Lite-On	LED, Orange, SMD
37	1	D15	1SMB5922BT3G	ON Semiconductor	Diode, Zener, 7.5 V, 550 mW, SMB
38	1	F1	0440002.WR	Littelfuse	Fuse, 2 A, 32 V, SMD
39	1	FB1	BK1608HS600-T	Taiyo Yuden	Ferrite Bead, 60 ohm @ 100 MHz, 0.8 A, 0603
40	8	J1, J12, J14, J16, J19, J28, J29, J30	TSW-103-07-G-S	Samtec, Inc.	Header, TH, 100mil, 3x1, Gold plated, 230 mil above insulator
41	1	J2	TSW-108-07-G-D	Samtec	Header, 100mil, 8x2, Gold, TH
42	17	J3, J8, J9, J10, J11, J13, J15, J17, J18, J20, J21, J22, J23, J25, J26, J27, J34	5-146261-1	TE Connectivity	Header, 100mil, 2x1, Gold plated, TH
43	2	J4, J5	0022112042	Molex	Header, 100mil, 4x1, White, TH
44	2	J6, J7	QSH-020-01-H-D-DP-A	Samtec	Receptacle, Differential, 0.5mm, 10 pair x2, Gold, SMT
45	1	J24	PJ-102A	CUI Inc.	Connector, DC Jack 2.1X5.5 mm, TH
46	1	J31	QTH-020-04-L-D-DP-A	Samtec	Header(shrouded), 0.5mm, 10 pair x 2, Gold, SMT
47	1	J32	TSW-104-07-G-D	Samtec	Header, 100mil, 4x2, Gold, TH
48	1	J33	TSW-104-07-G-S	Samtec	Header, 100mil, 4x1, Gold, TH
49	1	J35	TSW-102-07-G-D	Samtec	Header, 100mil, 2x2, Gold, TH
50	1	J36	1734035-2	TE Connectivity	Connector, Receptacle, Mini-USB Type B, R/A, Top Mount SMT
51	7	L1, L2, L3, L4, L5, L6, L8	BLM18SG121TN1D	MuRata	Ferrite Bead, 120 ohm @ 100 MHz, 3 A, 0603
52	4	L11, L12, L21, L22	BLM18AG102SN1D	MuRata	Ferrite Bead, 1000 ohm @ 100 MHz, 0.4 A, 0603
53	4	L13, L15, L23, L25	1008PS-472KLB	Coilcraft	Inductor, Shielded, Ferrite, 4.7 uH, 0.7 A, 0.35 ohm, SMD

Table 1-19. BOM for DS90UB96X-Q1EVM Assembly Variant SV601176-002 (continued)

Item	Qty	Designator	Part Number	Manufacturer	Description
54	4	L14, L16, L24, L26	MSS7341T-104MLB	Coilcraft	Inductor, Shielded Drum Core, Ferrite, 100 μ H, 0.7 A, 0.28 ohm, SMD
55	4	L17, L18, L27, L28	BLM15HD182SN1D	MuRata	Ferrite Bead, 1800 ohm @ 100 MHz, 0.2 A, 0402
56	1	L31	7440650047	Würth Elektronik	Inductor, Shielded Drum Core, Ferrite, 4.7 μ H, 4.2 A, 0.02 ohm, SMD
57	1	LBL1	THT-13-457-10	Brady	Thermal Transfer Printable Labels, 1.250" W x 0.250" H - 10,000 per roll
58	2	Q1, Q2	BSS138	Fairchild Semiconductor	MOSFET, N-CH, 50 V, 0.22 A, SOT-23
59	15	R1, R3, R11, R25, R26, R27, R28, R34, R36, R39, R41, R110, R119, R128, R155	ERJ-2GE0R00X	Panasonic	RES, 0 ohm, 5%, 0.063W, 0402
60	1	R2	CRCW0402100RFKED	Vishay-Dale	RES, 100 ohm, 1%, 0.063W, 0402
61	1	R4	CRCW0402470RJNED	Vishay-Dale	RES, 470 ohm, 5%, 0.063W, 0402
62	3	R5, R16, R17	CRCW040210K0JNED	Vishay-Dale	RES, 10k ohm, 5%, 0.063W, 0402
63	5	R6, R97, R105, R118, R122	CRCW0402100KJNED	Vishay-Dale	RES, 100k ohm, 5%, 0.063W, 0402
64	1	R7	CRCW040282K5FKED	Vishay-Dale	RES, 82.5 k, 1%, 0.063 W, 0402
65	1	R8	CRCW040268K1FKED	Vishay-Dale	RES, 68.1 k, 1%, 0.063 W, 0402
66	1	R9	CRCW040256K2FKED	Vishay-Dale	RES, 56.2 k, 1%, 0.063 W, 0402
67	1	R10	CRCW040213K3FKED	Vishay-Dale	RES, 13.3 k, 1%, 0.063 W, 0402
68	1	R13	CRCW0402102KFKED	Vishay-Dale	RES, 102 k, 1%, 0.063 W, 0402
69	1	R14	CRCW0402137KFKED	Vishay-Dale	RES, 137 k, 1%, 0.063 W, 0402
70	1	R15	CRCW0402210KFKED	Vishay-Dale	RES, 210 k, 1%, 0.063 W, 0402
71	7	R20, R21, R22, R23, R76, R102, R115	CRCW04024K70JNED	Vishay-Dale	RES, 4.7k ohm, 5%, 0.063W, 0402
72	1	R29	CRCW040240K2FKED	Vishay-Dale	RES, 40.2 k, 1%, 0.063 W, 0402
73	15	R58, R59, R72, R73, R88, R90, R96, R99, R106, R108, R109, R112, R120, R121, R129	CRCW06030000Z0EA	Vishay-Dale	RES, 0 ohm, 5%, 0.1W, 0603
74	11	R60, R61, R62, R63, R64, R65, R66, R67, R125, R126, R127	CRCW0402220RJNED	Vishay-Dale	RES, 220, 5%, 0.063 W, 0402
75	8	R68, R69, R70, R71, R80, R81, R82, R83	ERJ-3EKF1001V	Panasonic	RES, 1.00 k, 1%, 0.1 W, 0603
76	4	R74, R75, R84, R85	CRCW040257R6FKED	Vishay-Dale	RES, 57.6, 1%, 0.063 W, 0402
77	2	R77, R147	CRCW040233R0JNED	Vishay-Dale	RES, 33 ohm, 5%, 0.063W, 0402
78	4	R78, R79, R86, R87	CRCW0402200RJNED	Vishay-Dale	RES, 200, 5%, 0.063 W, 0402

Table 1-19. BOM for DS90UB96X-Q1EVM Assembly Variant SV601176-002 (continued)

Item	Qty	Designator	Part Number	Manufacturer	Description
79	6	R89, R95, R98, R103, R107, R154	CRCW040210K0FKED	Vishay-Dale	RES, 10.0k ohm, 1%, 0.063W, 0402
80	3	R91, R100, R111	CRCW040229K4FKED	Vishay-Dale	RES, 29.4 k, 1%, 0.063 W, 0402
81	1	R92	CRCW0402124KFKED	Vishay-Dale	RES, 124k ohm, 1%, 0.063W, 0402
82	1	R93	CRCW040222K1FKED	Vishay-Dale	RES, 22.1k ohm, 1%, 0.063W, 0402
83	4	R94, R101, R104, R114	CRCW04023K24FKED	Vishay-Dale	RES, 3.24k ohm, 1%, 0.063W, 0402
84	1	R113	CRCW04021K87FKED	Vishay-Dale	RES, 1.87k ohm, 1%, 0.063W, 0402
85	1	R116	CRCW04024K99FKED	Vishay-Dale	RES, 4.99k ohm, 1%, 0.063W, 0402
86	2	R123, R124	CRCW04022K40JNED	Vishay-Dale	RES, 2.4 k, 5%, 0.063 W, 0402
87	16	R130, R131, R132, R133, R134, R135, R136, R137, R138, R139, R140, R141, R142, R143, R144, R145	ERJ-1GE0R00C	Panasonic	RES, 0, 5%, 0.05 W, 0201
88	1	R148	CRCW04021K50JNED	Vishay-Dale	RES, 1.5k ohm, 5%, 0.063W, 0402
89	2	R149, R153	CRCW040233K0JNED	Vishay-Dale	RES, 33k ohm, 5%, 0.063W, 0402
90	1	R150	CRCW06031M20JNEA	Vishay-Dale	RES, 1.2Meg ohm, 5%, 0.1W, 0603
91	1	R152	CRCW0603200RFKEA	Vishay-Dale	RES, 200 ohm, 1%, 0.1W, 0603
92	1	S1	219-4LPST	CTS Electrocomponents	Switch, SPST 4 Pos, Top Actuated, SMT
93	2	S2, S3	KSR221GLFS	C and K Components	Switch, Normally open, 2.3N force, 200k operations, SMD
94	15	SH-J1, SH-J2, SH-J3, SH-J4, SH-J5, SH-J6, SH-J7, SH-J8, SH-J9, SH-J10, SH-J11, SH-J12, SH-J13, SH-J14, SH-J15	SPC02SYAN	Sullins Connector Solutions	Shunt, 100mil, Flash Gold, Black
95	1	SW1	219-2LPST	CTS Electrocomponents	Switch, Slide, SPST 2 poles, SMT
96	1	T1	ACM9070-701-2PL	TDK	Common Mode Filter for Power Line
97	1	U1	DS90UB964TRGCRQ1	Texas Instruments	FPD-Link III Camera Hub Deserializer, RGC0064G
98	3	U2, U4, U6	LM2941LD/NOPB	Texas Instruments	1A Low Dropout Adjustable Regulator, 8-pin LLP, Pb-Free
99	1	U3	TPS54225PWPR	Texas Instruments	4.5V to 18V Input, 2-A Synchronous Step-Down SWIFT™ Converter, PWP0014E
100	1	U5	TPS74801TDRCRQ1	Texas Instruments	Single Output LDO, 1.5 A, Adjustable 0.8 to 3.6 V Output, 0.8 to 5.5 V Input, with Programmable Soft Start, 10-pin SON (DRC), -40 to 105 degC, Green (RoHS & no Sb/Br)

Table 1-19. BOM for DS90UB96X-Q1EVM Assembly Variant SV601176-002 (continued)

Item	Qty	Designator	Part Number	Manufacturer	Description
101	1	U7	TPS767D318PWP	Texas Instruments	Dual Output LDO, 1 A, Fixed 1.8, 3.3 V Output, 2.7 to 10 V Input, 28-pin HTSSOP (PWP), -40 to 125 degC, Green (RoHS & no Sb/Br)
102	1	U8	TPD4E004DRYR	Texas Instruments	ESD-Protection Array for High-Speed Data Interfaces, 4 Channels, -40 to +85 degC, 6-pin SON (DRY), Green (RoHS & no Sb/Br)
103	1	U9	TPS73533DRBR	Texas Instruments	500mA, Low Quiescent Current, Ultra-Low Noise, High PSRR Low-Dropout Linear Regulator, DRB0008A
104	1	U10	MSP430F5529IPN	Texas Instruments	25 MHz Mixed Signal Microcontroller with 128 KB Flash, 8192 B SRAM and 63 GPIOs, -40 to 85 degC, 80-pin QFP (PN), Green (RoHS & no Sb/Br)
105	1	U11	TCA9406DCUR	Texas Instruments	TCA9406 Dual Bidirectional 1-MHz I2C-BUS and SMBus Voltage Level-Translator, 1.65 to 3.6 V, -40 to 85 degC, 8-pin US8 (DCU), Green (RoHS & no Sb/Br)
106	1	Y1	KC5032A25.0000CMGE00	AVX	OSC, 25 MHz, 1.6 to 5.5 V, SMD
107	1	Y2	ABM3-25.000MHZ-D2Y-T	Abracon Corporation	Crystal, 25 MHz, 18 pF, SMD
108	1	Y3	ABM3-24.000MHZ-D2Y-T	Abracon Corporation	Crystal, 24 MHz, 18 pF, SMD
109	0	C2, C7, C13, C21, C27, C32, C43	CL21A106KAFN3NE	Samsung Electro-Mechanics	CAP, CERM, 10 µF, 25 V, +/- 10%, X5R, 0805
110	0	C66, C71	GRM1555C1H270JA01D	MuRata	CAP, CERM, 27 pF, 50 V, +/- 5%, C0G/NP0, 0402
111	0	J37	TSW-104-07-G-D	Samtec	Header, 100mil, 4x2, Gold, TH
112	0	J38	TSW-104-07-G-S	Samtec	Header, 100mil, 4x1, Gold, TH
113	0	J39	TSW-102-07-G-D	Samtec	Header, 100mil, 2x2, Gold, TH
114	0	L19, L20, L29, L30	DLW21SN900HQ2L	MuRata	Coupled inductor, 0.28 A, 0.41 ohm, +/- 25%, SMD
115	0	R12, R18, R19, R31, R32, R33, R35, R37, R38, R40, R43, R44, R45, R47, R48, R49, R50, R51, R52, R53, R54, R55, R56, R57, R146, R151	ERJ-2GE0R00X	Panasonic	RES, 0 ohm, 5%, 0.063W, 0402
116	0	R24, R30, R117	CRCW040210K0FKED	Vishay-Dale	RES, 10.0k ohm, 1%, 0.063W, 0402
117	0	R42, R46	CRCW06030000Z0EA	Vishay-Dale	RES, 0 ohm, 5%, 0.1W, 0603

PCB Schematics

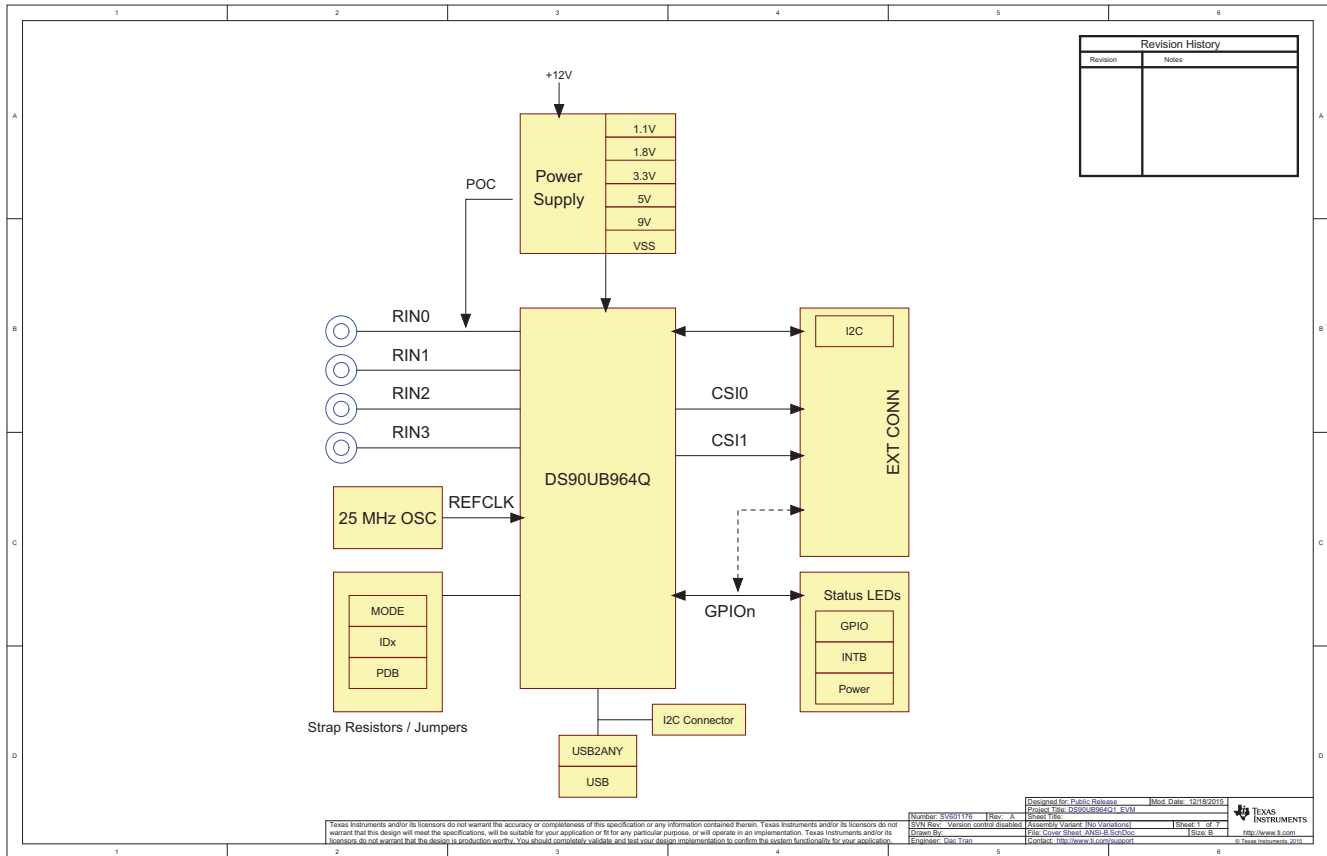

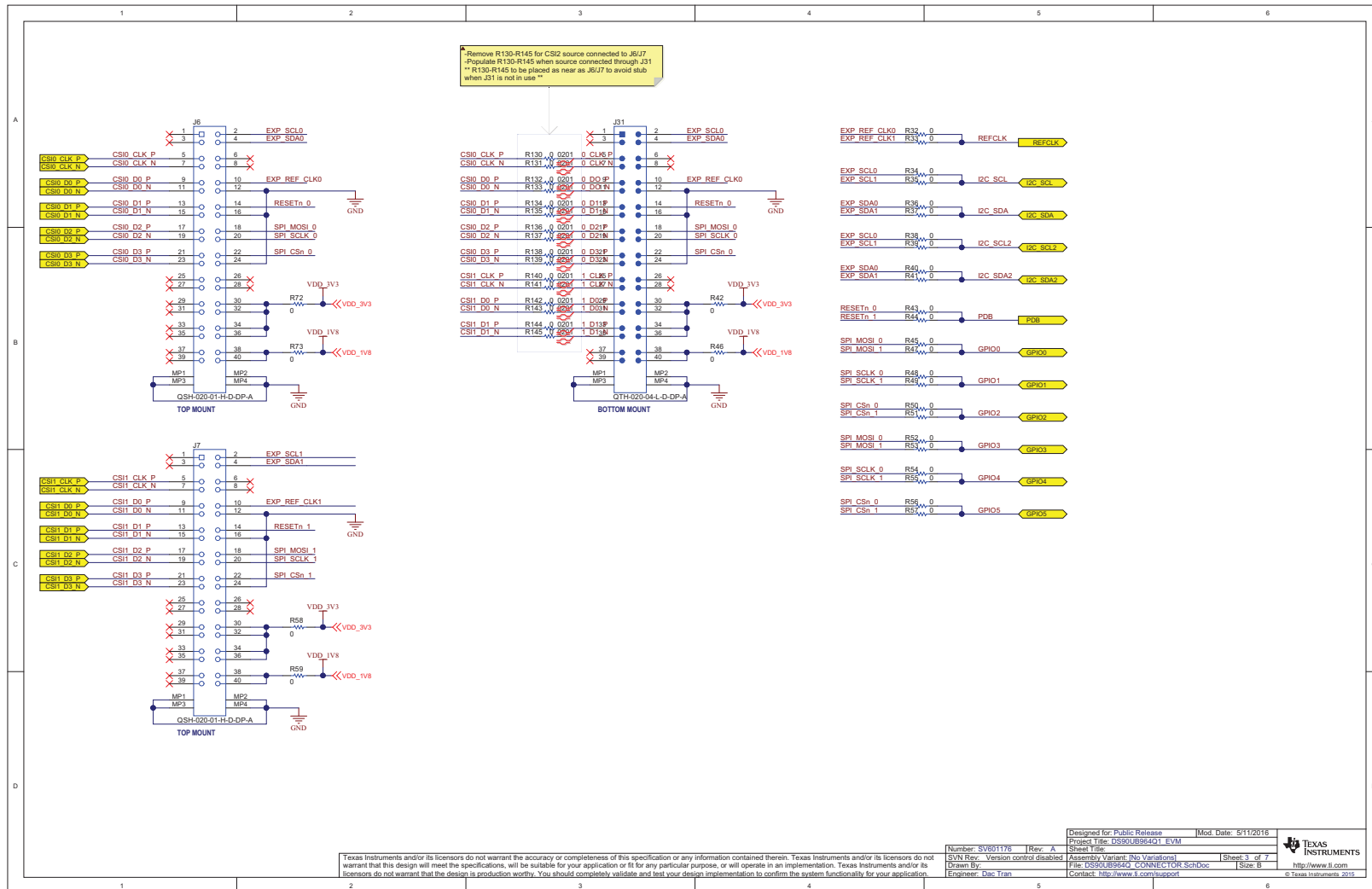

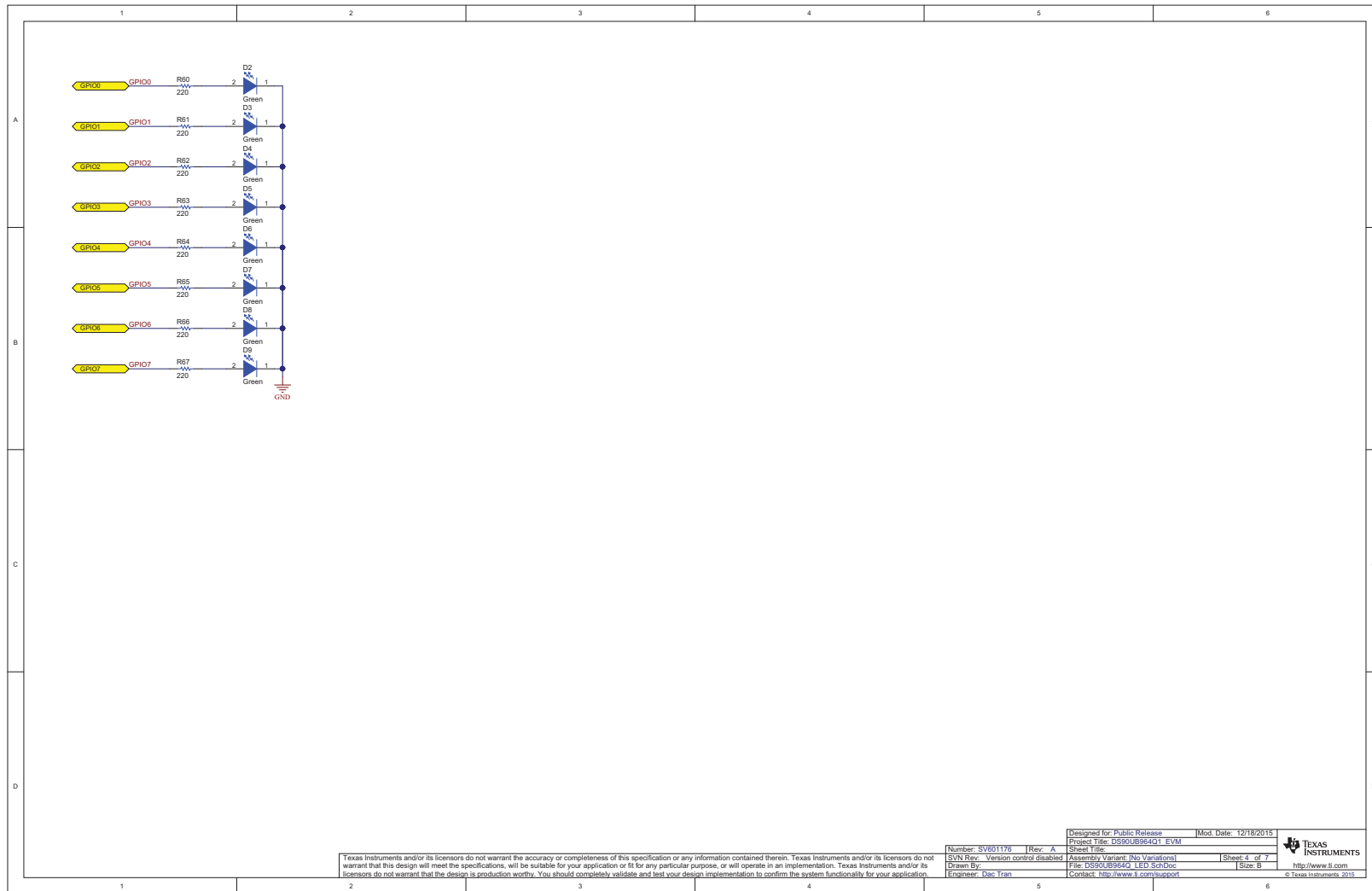

Texas Instruments and/or its licensors do not warrant the accuracy or completeness of this specification or any information contained therein. Texas Instruments and/or its licensors do not warrant that this design will meet the specifications, will be suitable for your application or fit for any particular purpose, or will operate in an implementation. Texas Instruments and/or its licensors do not warrant that the design is production worthy. You should completely validate and test your design implementation to confirm the system functionality for your application.

Number: SV601176	Rev: A	Designed for: Public Release	Mod. Date: 12/18/2015
SVN Rev: Version control disabled		Project Title: DS90UB964G11 EVM	
Drawn By:		Sheet: 4 of 7	
Engineer: dac Tran		Assembly Variant: [No Variations]	
		File: DS90UB964G11 E.D_SchDoc	Size: B
		Contact: http://www.ti.com/support	

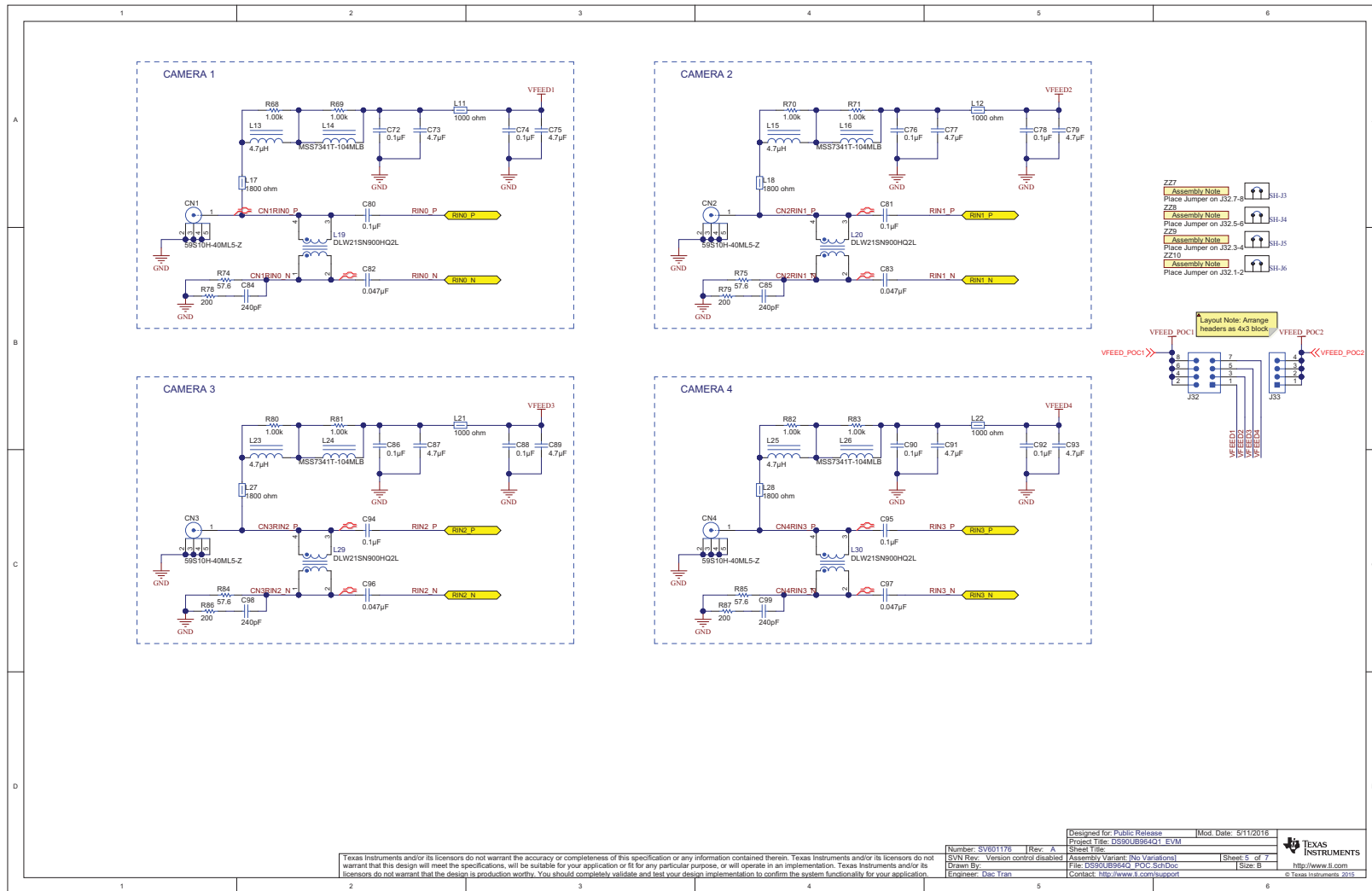

Texas Instruments and/or its licensors do not warrant the accuracy or completeness of this specification or any information contained therein. Texas Instruments and/or its licensors do not warrant that this design will meet the specifications, will be suitable for your application or fit for any particular purpose, or will operate in an implementation. Texas Instruments and/or its licensors do not warrant that the design is production worthy. You should completely validate and test your design implementation to confirm the system functionality for your application.

Number: SV601176	Rev: A	Designed for: Public Release	Mod. Date: 5/11/2016
Drawn By: Engineer, Dao Tran	Project Title: DS90UB944GT-EVM	Sheet Title:	TEXAS INSTRUMENTS
Engineer, Dao Tran	SVN Rev: Version control disabled	Assembly Variant: [No Variations]	Sheet: 5 of 7
	File: DS90UB944GT_POC_SchDoc	Size: B	http://www.ti.com
	Contact: http://www.ti.com/support		© Texas Instruments 2016

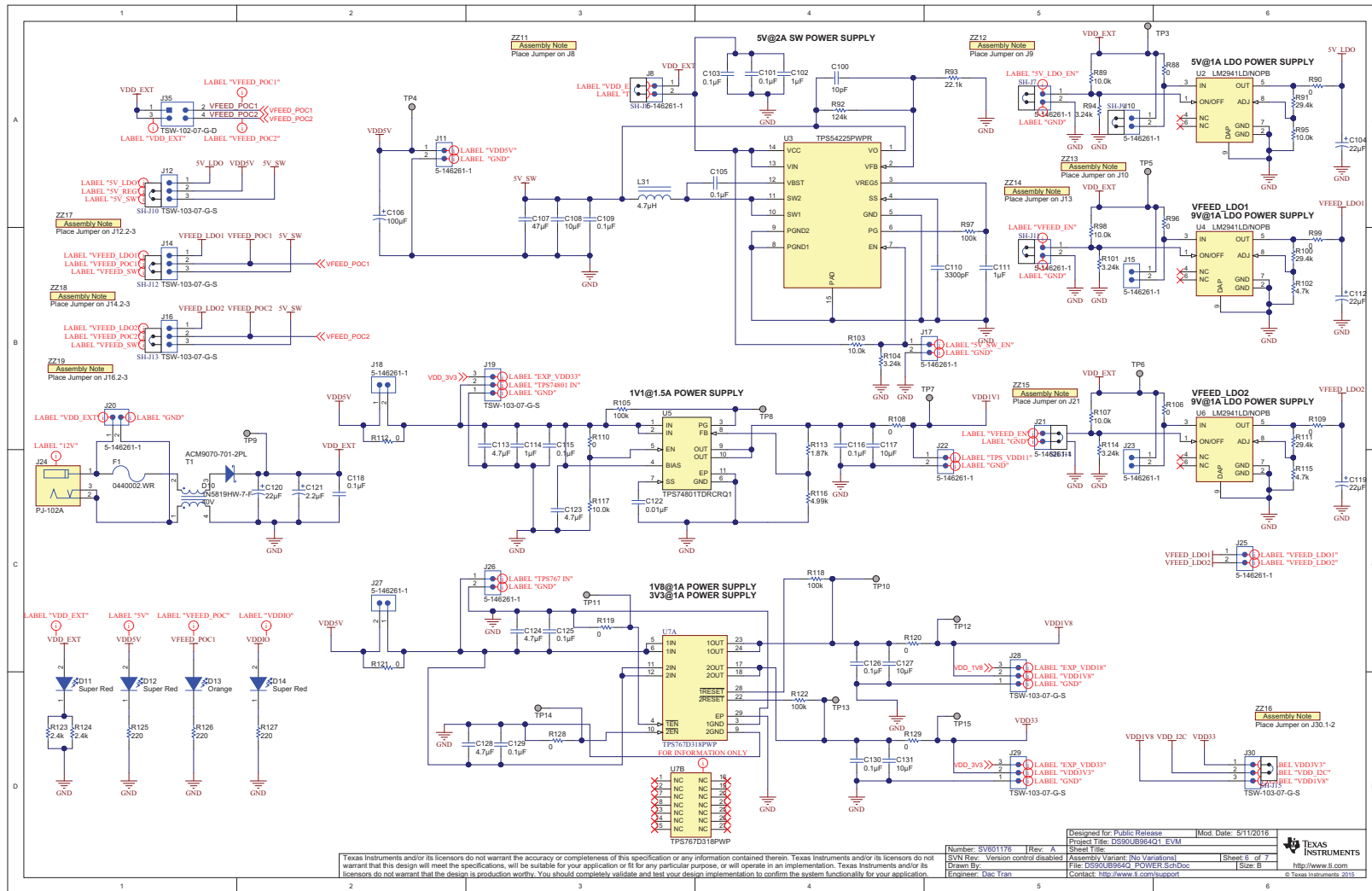

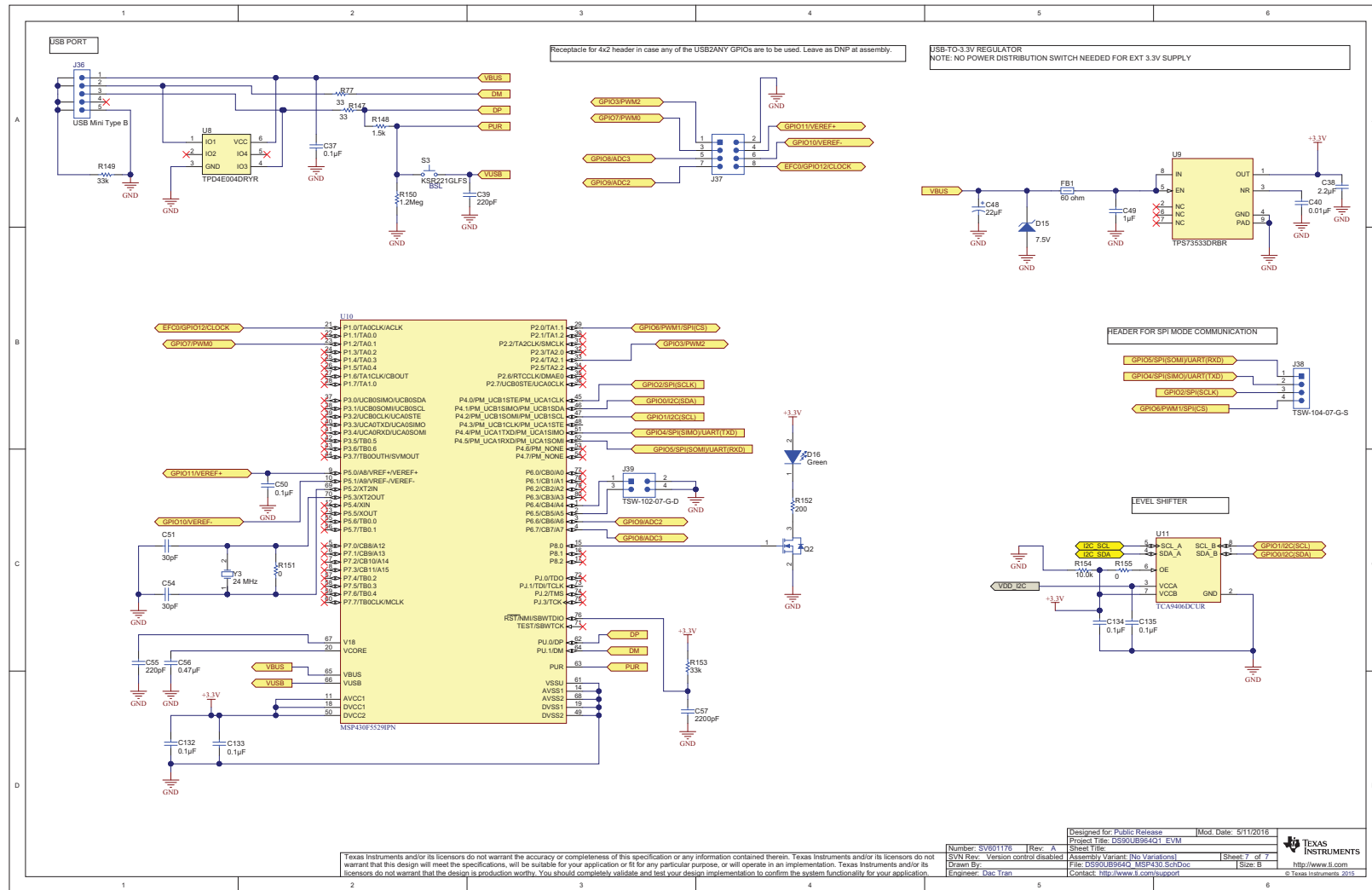

Board Layout

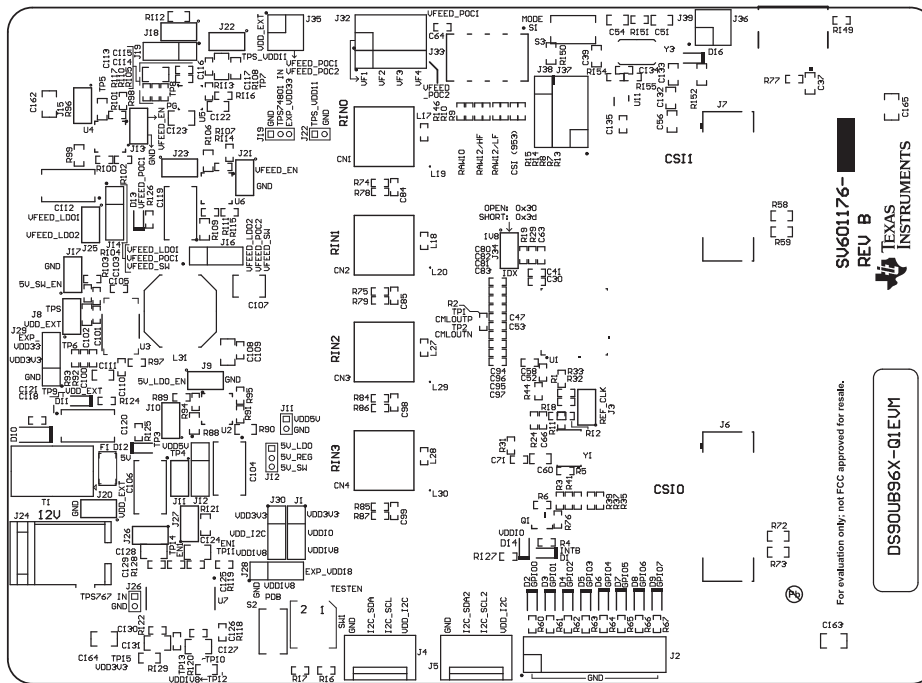

Figure 3-1. Top Overlay

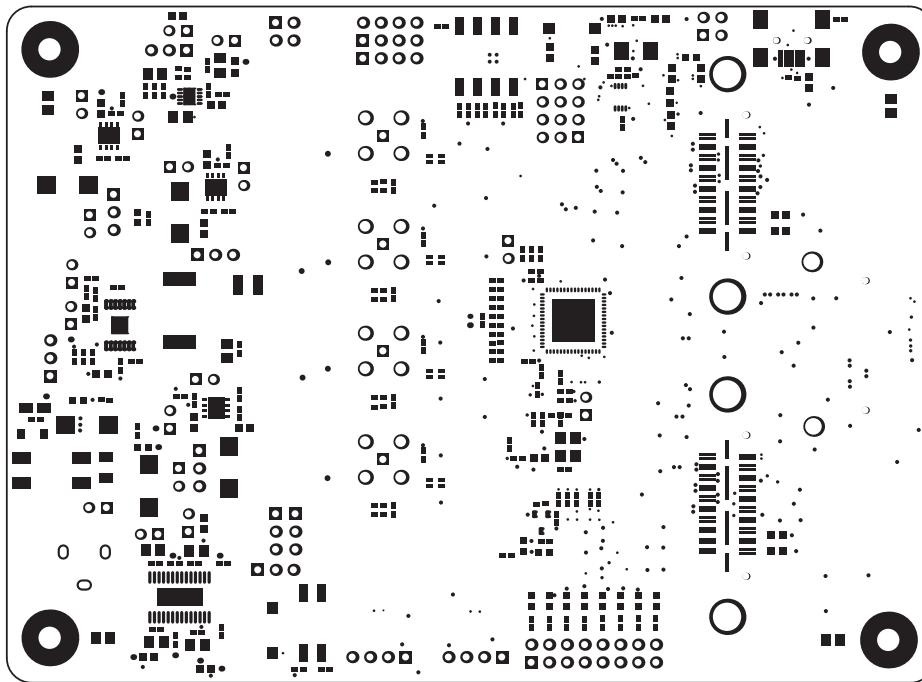

Figure 3-2. Top Solder

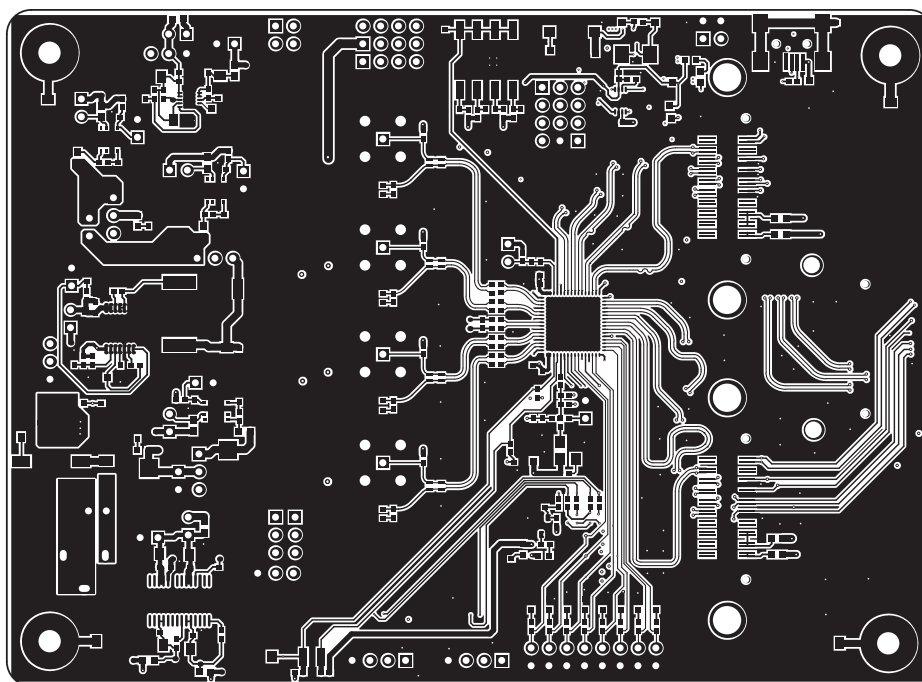

Figure 3-3. Top Layer 1

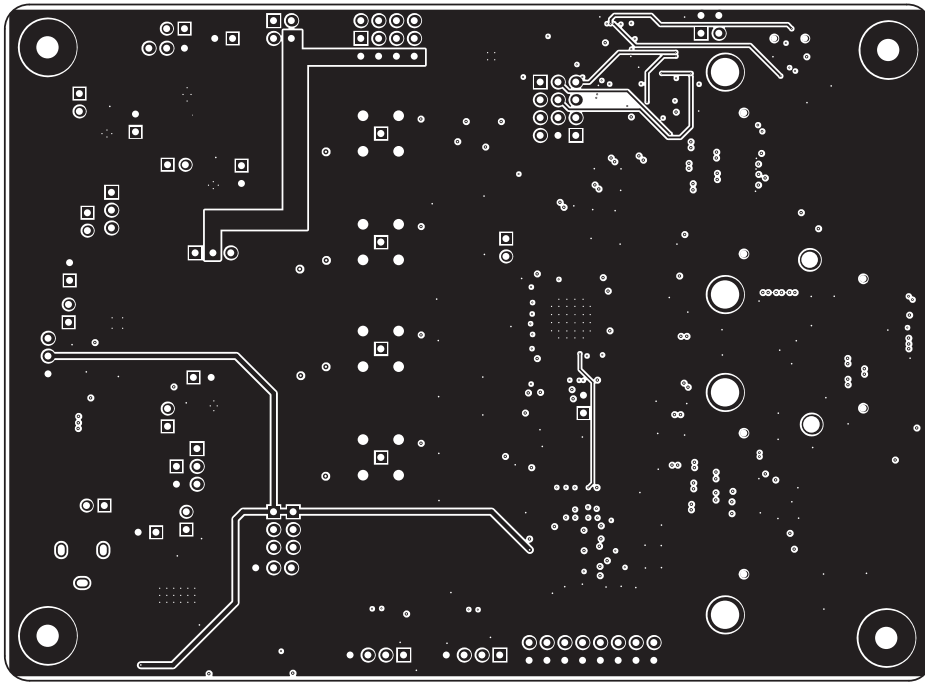

Figure 3-4. Layer 2

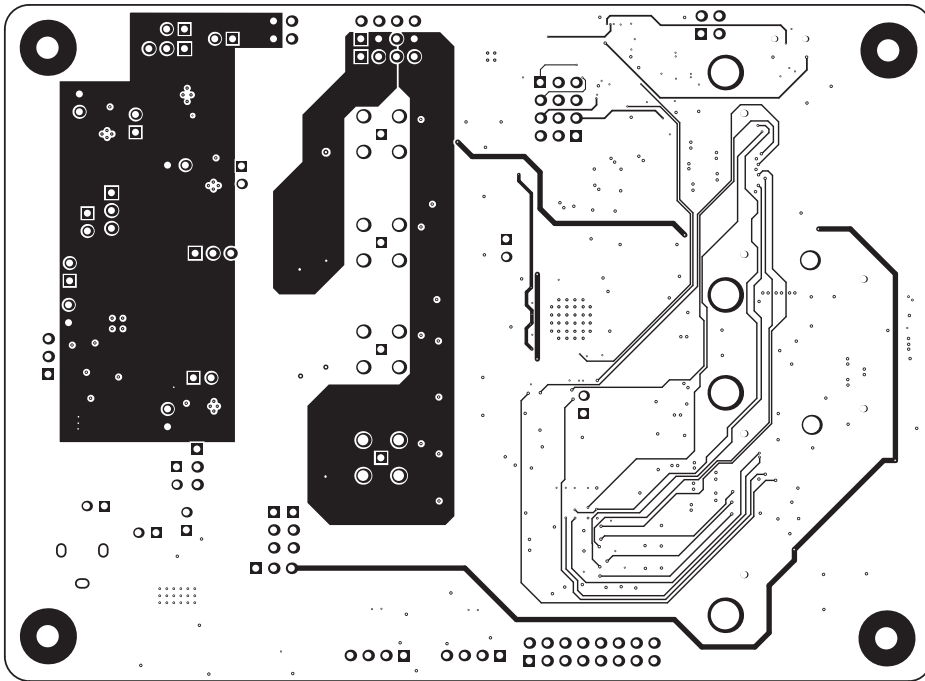

Figure 3-5. Layer 3

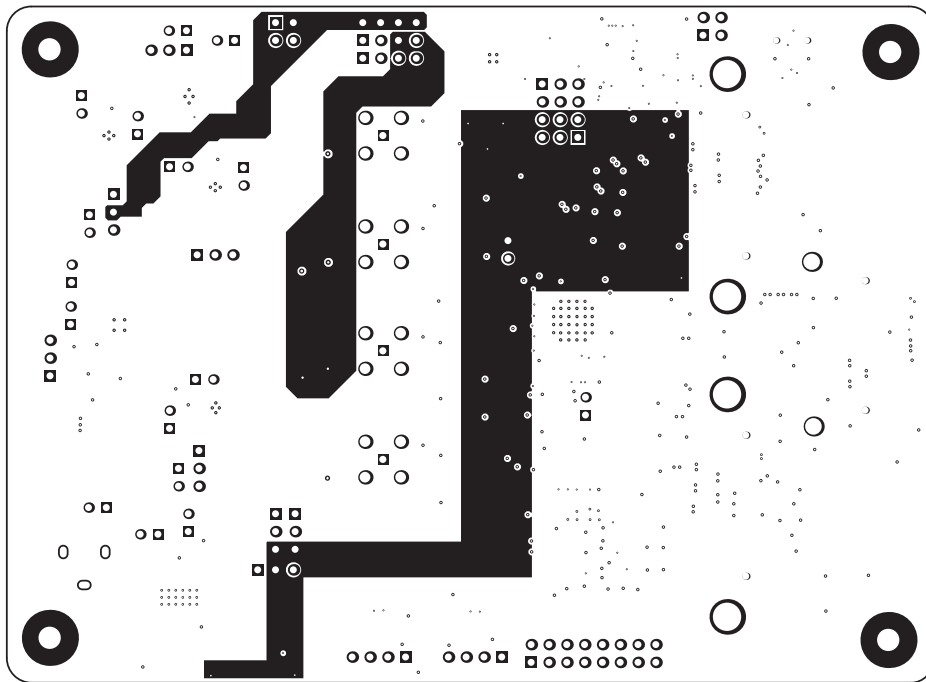

Figure 3-6. Layer 4

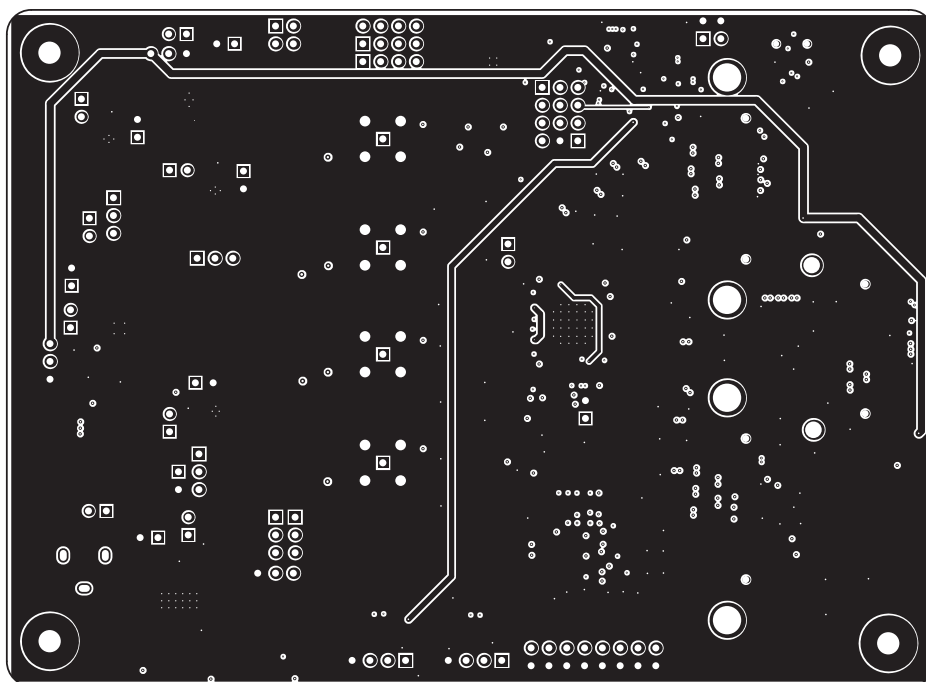

Figure 3-7. Layer 5

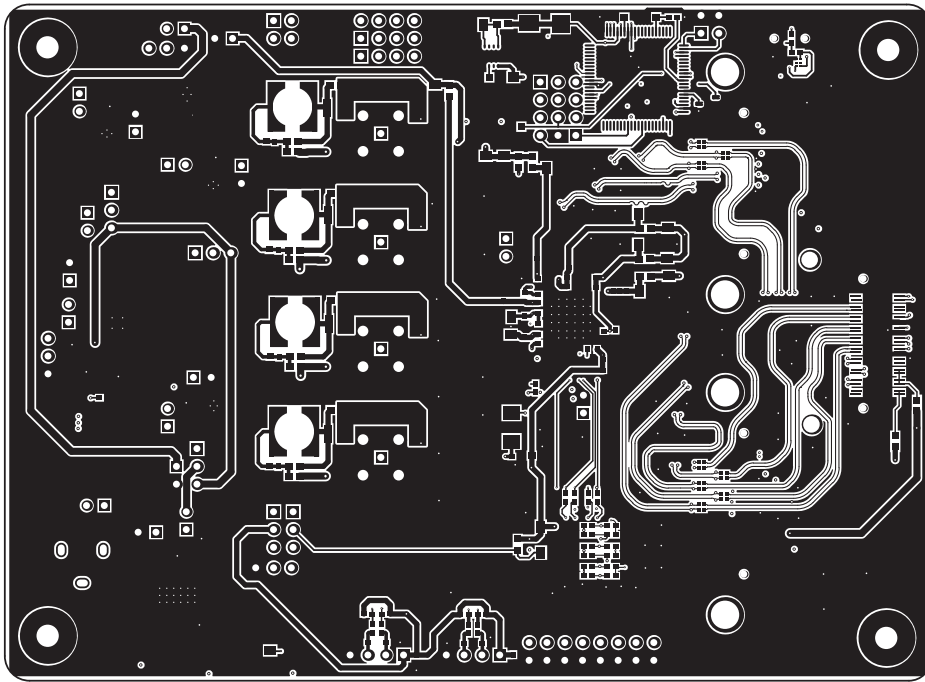

Figure 3-8. Bottom Layer 6

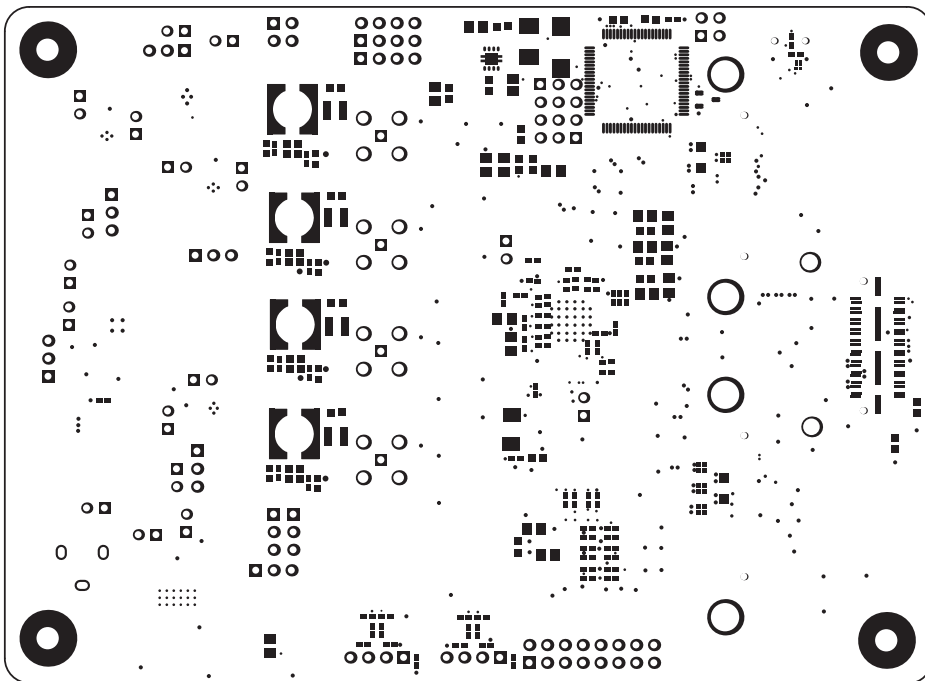

Figure 3-9. Bottom solder

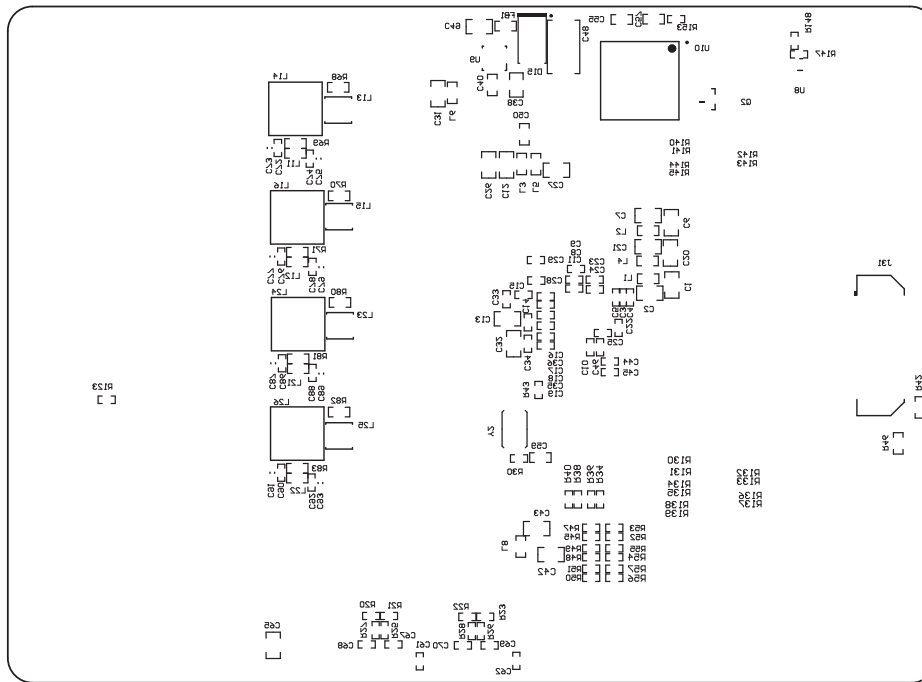
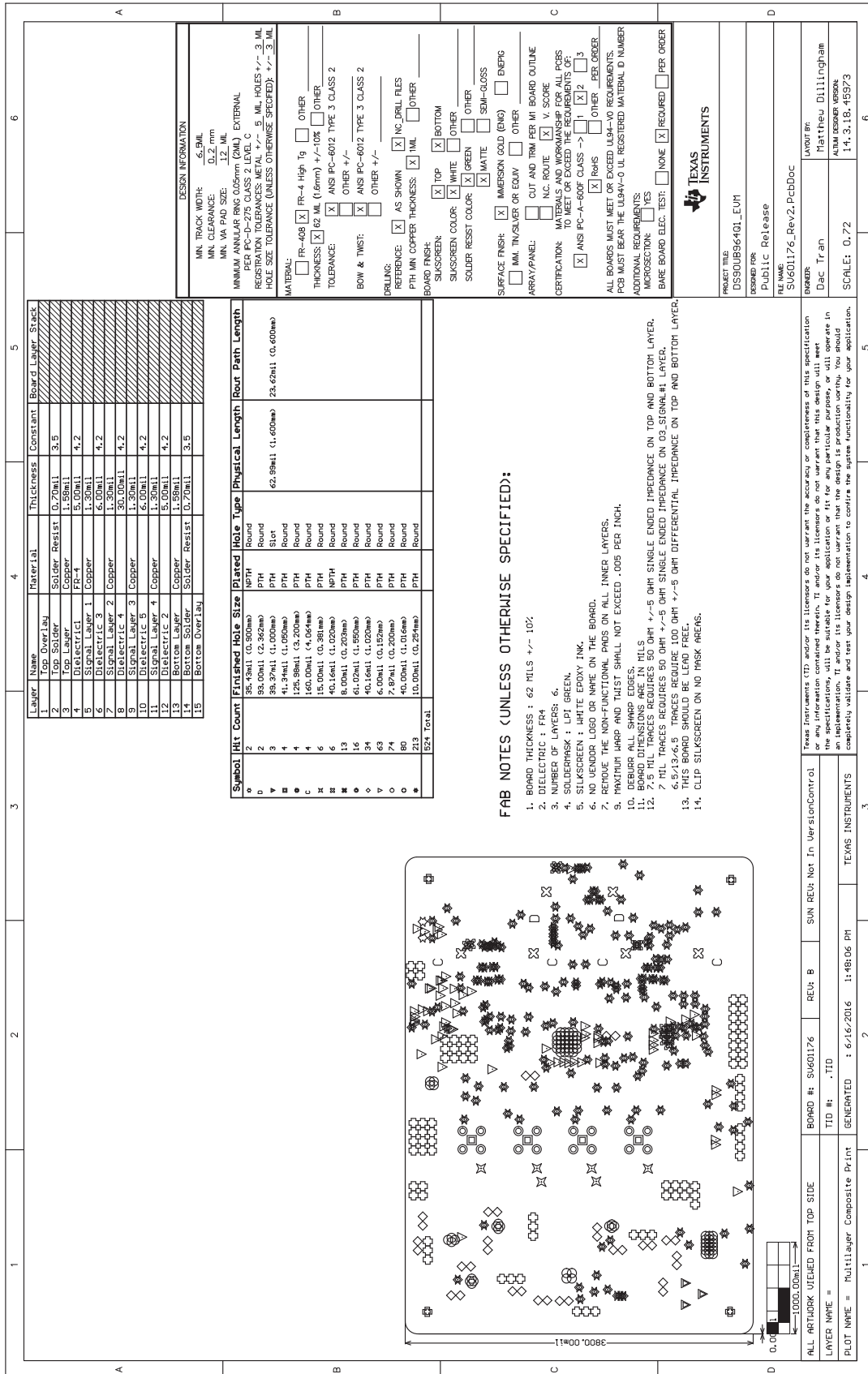

Figure 3-10. Bottom Overlay



STANDARD TERMS AND CONDITIONS FOR EVALUATION MODULES

1. *Delivery:* TI delivers TI evaluation boards, kits, or modules, including any accompanying demonstration software, components, or documentation (collectively, an "EVM" or "EVMs") to the User ("User") in accordance with the terms and conditions set forth herein. Acceptance of the EVM is expressly subject to the following terms and conditions.
 - 1.1 EVMs are intended solely for product or software developers for use in a research and development setting to facilitate feasibility evaluation, experimentation, or scientific analysis of TI semiconductor products. EVMs have no direct function and are not finished products. EVMs shall not be directly or indirectly assembled as a part or subassembly in any finished product. For clarification, any software or software tools provided with the EVM ("Software") shall not be subject to the terms and conditions set forth herein but rather shall be subject to the applicable terms and conditions that accompany such Software
 - 1.2 EVMs are not intended for consumer or household use. EVMs may not be sold, sublicensed, leased, rented, loaned, assigned, or otherwise distributed for commercial purposes by Users, in whole or in part, or used in any finished product or production system.
2. *Limited Warranty and Related Remedies/Disclaimers:*
 - 2.1 These terms and conditions do not apply to Software. The warranty, if any, for Software is covered in the applicable Software License Agreement.
 - 2.2 TI warrants that the TI EVM will conform to TI's published specifications for ninety (90) days after the date TI delivers such EVM to User. Notwithstanding the foregoing, TI shall not be liable for any defects that are caused by neglect, misuse or mistreatment by an entity other than TI, including improper installation or testing, or for any EVMs that have been altered or modified in any way by an entity other than TI. Moreover, TI shall not be liable for any defects that result from User's design, specifications or instructions for such EVMs. Testing and other quality control techniques are used to the extent TI deems necessary or as mandated by government requirements. TI does not test all parameters of each EVM.
 - 2.3 If any EVM fails to conform to the warranty set forth above, TI's sole liability shall be at its option to repair or replace such EVM, or credit User's account for such EVM. TI's liability under this warranty shall be limited to EVMs that are returned during the warranty period to the address designated by TI and that are determined by TI not to conform to such warranty. If TI elects to repair or replace such EVM, TI shall have a reasonable time to repair such EVM or provide replacements. Repaired EVMs shall be warranted for the remainder of the original warranty period. Replaced EVMs shall be warranted for a new full ninety (90) day warranty period.
3. *Regulatory Notices:*
 - 3.1 *United States*
 - 3.1.1 *Notice applicable to EVMs not FCC-Approved:*

This kit is designed to allow product developers to evaluate electronic components, circuitry, or software associated with the kit to determine whether to incorporate such items in a finished product and software developers to write software applications for use with the end product. This kit is not a finished product and when assembled may not be resold or otherwise marketed unless all required FCC equipment authorizations are first obtained. Operation is subject to the condition that this product not cause harmful interference to licensed radio stations and that this product accept harmful interference. Unless the assembled kit is designed to operate under part 15, part 18 or part 95 of this chapter, the operator of the kit must operate under the authority of an FCC license holder or must secure an experimental authorization under part 5 of this chapter.
 - 3.1.2 *For EVMs annotated as FCC – FEDERAL COMMUNICATIONS COMMISSION Part 15 Compliant:*

CAUTION

This device complies with part 15 of the FCC Rules. Operation is subject to the following two conditions: (1) This device may not cause harmful interference, and (2) this device must accept any interference received, including interference that may cause undesired operation.

Changes or modifications not expressly approved by the party responsible for compliance could void the user's authority to operate the equipment.

FCC Interference Statement for Class A EVM devices

NOTE: This equipment has been tested and found to comply with the limits for a Class A digital device, pursuant to part 15 of the FCC Rules. These limits are designed to provide reasonable protection against harmful interference when the equipment is operated in a commercial environment. This equipment generates, uses, and can radiate radio frequency energy and, if not installed and used in accordance with the instruction manual, may cause harmful interference to radio communications. Operation of this equipment in a residential area is likely to cause harmful interference in which case the user will be required to correct the interference at his own expense.

FCC Interference Statement for Class B EVM devices

NOTE: This equipment has been tested and found to comply with the limits for a Class B digital device, pursuant to part 15 of the FCC Rules. These limits are designed to provide reasonable protection against harmful interference in a residential installation. This equipment generates, uses and can radiate radio frequency energy and, if not installed and used in accordance with the instructions, may cause harmful interference to radio communications. However, there is no guarantee that interference will not occur in a particular installation. If this equipment does cause harmful interference to radio or television reception, which can be determined by turning the equipment off and on, the user is encouraged to try to correct the interference by one or more of the following measures:

- Reorient or relocate the receiving antenna.
- Increase the separation between the equipment and receiver.
- Connect the equipment into an outlet on a circuit different from that to which the receiver is connected.
- Consult the dealer or an experienced radio/TV technician for help.

3.2 Canada

3.2.1 For EVMs issued with an Industry Canada Certificate of Conformance to RSS-210

Concerning EVMs Including Radio Transmitters:

This device complies with Industry Canada license-exempt RSS standard(s). Operation is subject to the following two conditions: (1) this device may not cause interference, and (2) this device must accept any interference, including interference that may cause undesired operation of the device.

Concernant les EVMs avec appareils radio:

Le présent appareil est conforme aux CNR d'Industrie Canada applicables aux appareils radio exempts de licence. L'exploitation est autorisée aux deux conditions suivantes: (1) l'appareil ne doit pas produire de brouillage, et (2) l'utilisateur de l'appareil doit accepter tout brouillage radioélectrique subi, même si le brouillage est susceptible d'en compromettre le fonctionnement.

Concerning EVMs Including Detachable Antennas:

Under Industry Canada regulations, this radio transmitter may only operate using an antenna of a type and maximum (or lesser) gain approved for the transmitter by Industry Canada. To reduce potential radio interference to other users, the antenna type and its gain should be so chosen that the equivalent isotropically radiated power (e.i.r.p.) is not more than that necessary for successful communication. This radio transmitter has been approved by Industry Canada to operate with the antenna types listed in the user guide with the maximum permissible gain and required antenna impedance for each antenna type indicated. Antenna types not included in this list, having a gain greater than the maximum gain indicated for that type, are strictly prohibited for use with this device.

Concernant les EVMs avec antennes détachables

Conformément à la réglementation d'Industrie Canada, le présent émetteur radio peut fonctionner avec une antenne d'un type et d'un gain maximal (ou inférieur) approuvé pour l'émetteur par Industrie Canada. Dans le but de réduire les risques de brouillage radioélectrique à l'intention des autres utilisateurs, il faut choisir le type d'antenne et son gain de sorte que la puissance isotrope rayonnée équivalente (p.i.r.e.) ne dépasse pas l'intensité nécessaire à l'établissement d'une communication satisfaisante. Le présent émetteur radio a été approuvé par Industrie Canada pour fonctionner avec les types d'antenne énumérés dans le manuel d'usage et ayant un gain admissible maximal et l'impédance requise pour chaque type d'antenne. Les types d'antenne non inclus dans cette liste, ou dont le gain est supérieur au gain maximal indiqué, sont strictement interdits pour l'exploitation de l'émetteur.

3.3 Japan

3.3.1 *Notice for EVMs delivered in Japan:* Please see http://www.tij.co.jp/lstds/ti_ja/general/eStore/notice_01.page 日本国内に輸入される評価用キット、ボードについては、次のところをご覧ください。
http://www.tij.co.jp/lstds/ti_ja/general/eStore/notice_01.page

3.3.2 *Notice for Users of EVMs Considered "Radio Frequency Products" in Japan:* EVMs entering Japan may not be certified by TI as conforming to Technical Regulations of Radio Law of Japan.

If User uses EVMs in Japan, not certified to Technical Regulations of Radio Law of Japan, User is required by Radio Law of Japan to follow the instructions below with respect to EVMs:

1. Use EVMs in a shielded room or any other test facility as defined in the notification #173 issued by Ministry of Internal Affairs and Communications on March 28, 2006, based on Sub-section 1.1 of Article 6 of the Ministry's Rule for Enforcement of Radio Law of Japan,
2. Use EVMs only after User obtains the license of Test Radio Station as provided in Radio Law of Japan with respect to EVMs, or
3. Use of EVMs only after User obtains the Technical Regulations Conformity Certification as provided in Radio Law of Japan with respect to EVMs. Also, do not transfer EVMs, unless User gives the same notice above to the transferee. Please note that if User does not follow the instructions above, User will be subject to penalties of Radio Law of Japan.

【無線電波を送信する製品の開発キットをお使いになる際の注意事項】 開発キットの中には技術基準適合証明を受けていないものがあります。技術適合証明を受けていないものご使用に際しては、電波法遵守のため、以下のいずれかの措置を取っていただく必要がありますのでご注意ください。

1. 電波法施行規則第6条第1項第1号に基づく平成18年3月28日総務省告示第173号で定められた電波暗室等の試験設備でご使用いただく。
2. 実験局の免許を取得後ご使用いただく。
3. 技術基準適合証明を取得後ご使用いただく。

なお、本製品は、上記の「ご使用にあたっての注意」を譲渡先、移転先に通知しない限り、譲渡、移転できないものとします。

上記を遵守頂けない場合は、電波法の罰則が適用される可能性があることをご留意ください。日本テキサス・インスツルメンツ株式会社
東京都新宿区西新宿 6 丁目 2 4 番 1 号
西新宿三井ビル

3.3.3 *Notice for EVMs for Power Line Communication:* Please see http://www.tij.co.jp/llds/ti_ja/general/eStore/notice_02.page
電力線搬送波通信についての開発キットをお使いになる際の注意事項については、次のところをご覧ください。http://www.tij.co.jp/llds/ti_ja/general/eStore/notice_02.page

4 *EVM Use Restrictions and Warnings:*

4.1 EVMS ARE NOT FOR USE IN FUNCTIONAL SAFETY AND/OR SAFETY CRITICAL EVALUATIONS, INCLUDING BUT NOT LIMITED TO EVALUATIONS OF LIFE SUPPORT APPLICATIONS.

4.2 User must read and apply the user guide and other available documentation provided by TI regarding the EVM prior to handling or using the EVM, including without limitation any warning or restriction notices. The notices contain important safety information related to, for example, temperatures and voltages.

4.3 *Safety-Related Warnings and Restrictions:*

4.3.1 User shall operate the EVM within TI's recommended specifications and environmental considerations stated in the user guide, other available documentation provided by TI, and any other applicable requirements and employ reasonable and customary safeguards. Exceeding the specified performance ratings and specifications (including but not limited to input and output voltage, current, power, and environmental ranges) for the EVM may cause personal injury or death, or property damage. If there are questions concerning performance ratings and specifications, User should contact a TI field representative prior to connecting interface electronics including input power and intended loads. Any loads applied outside of the specified output range may also result in unintended and/or inaccurate operation and/or possible permanent damage to the EVM and/or interface electronics. Please consult the EVM user guide prior to connecting any load to the EVM output. If there is uncertainty as to the load specification, please contact a TI field representative. During normal operation, even with the inputs and outputs kept within the specified allowable ranges, some circuit components may have elevated case temperatures. These components include but are not limited to linear regulators, switching transistors, pass transistors, current sense resistors, and heat sinks, which can be identified using the information in the associated documentation. When working with the EVM, please be aware that the EVM may become very warm.

4.3.2 EVMs are intended solely for use by technically qualified, professional electronics experts who are familiar with the dangers and application risks associated with handling electrical mechanical components, systems, and subsystems. User assumes all responsibility and liability for proper and safe handling and use of the EVM by User or its employees, affiliates, contractors or designees. User assumes all responsibility and liability to ensure that any interfaces (electronic and/or mechanical) between the EVM and any human body are designed with suitable isolation and means to safely limit accessible leakage currents to minimize the risk of electrical shock hazard. User assumes all responsibility and liability for any improper or unsafe handling or use of the EVM by User or its employees, affiliates, contractors or designees.

4.4 User assumes all responsibility and liability to determine whether the EVM is subject to any applicable international, federal, state, or local laws and regulations related to User's handling and use of the EVM and, if applicable, User assumes all responsibility and liability for compliance in all respects with such laws and regulations. User assumes all responsibility and liability for proper disposal and recycling of the EVM consistent with all applicable international, federal, state, and local requirements.

5. *Accuracy of Information:* To the extent TI provides information on the availability and function of EVMs, TI attempts to be as accurate as possible. However, TI does not warrant the accuracy of EVM descriptions, EVM availability or other information on its websites as accurate, complete, reliable, current, or error-free.

6. *Disclaimers:*
- 6.1 EXCEPT AS SET FORTH ABOVE, EVMS AND ANY WRITTEN DESIGN MATERIALS PROVIDED WITH THE EVM (AND THE DESIGN OF THE EVM ITSELF) ARE PROVIDED "AS IS" AND "WITH ALL FAULTS." TI DISCLAIMS ALL OTHER WARRANTIES, EXPRESS OR IMPLIED, REGARDING SUCH ITEMS, INCLUDING BUT NOT LIMITED TO ANY IMPLIED WARRANTIES OF MERCHANTABILITY OR FITNESS FOR A PARTICULAR PURPOSE OR NON-INFRINGEMENT OF ANY THIRD PARTY PATENTS, COPYRIGHTS, TRADE SECRETS OR OTHER INTELLECTUAL PROPERTY RIGHTS.
- 6.2 EXCEPT FOR THE LIMITED RIGHT TO USE THE EVM SET FORTH HEREIN, NOTHING IN THESE TERMS AND CONDITIONS SHALL BE CONSTRUED AS GRANTING OR CONFERRING ANY RIGHTS BY LICENSE, PATENT, OR ANY OTHER INDUSTRIAL OR INTELLECTUAL PROPERTY RIGHT OF TI, ITS SUPPLIERS/LICENSORS OR ANY OTHER THIRD PARTY, TO USE THE EVM IN ANY FINISHED END-USER OR READY-TO-USE FINAL PRODUCT, OR FOR ANY INVENTION, DISCOVERY OR IMPROVEMENT MADE, CONCEIVED OR ACQUIRED PRIOR TO OR AFTER DELIVERY OF THE EVM.
7. *USER'S INDEMNITY OBLIGATIONS AND REPRESENTATIONS.* USER WILL DEFEND, INDEMNIFY AND HOLD TI, ITS LICENSORS AND THEIR REPRESENTATIVES HARMLESS FROM AND AGAINST ANY AND ALL CLAIMS, DAMAGES, LOSSES, EXPENSES, COSTS AND LIABILITIES (COLLECTIVELY, "CLAIMS") ARISING OUT OF OR IN CONNECTION WITH ANY HANDLING OR USE OF THE EVM THAT IS NOT IN ACCORDANCE WITH THESE TERMS AND CONDITIONS. THIS OBLIGATION SHALL APPLY WHETHER CLAIMS ARISE UNDER STATUTE, REGULATION, OR THE LAW OF TORT, CONTRACT OR ANY OTHER LEGAL THEORY, AND EVEN IF THE EVM FAILS TO PERFORM AS DESCRIBED OR EXPECTED.
8. *Limitations on Damages and Liability:*
- 8.1 *General Limitations.* IN NO EVENT SHALL TI BE LIABLE FOR ANY SPECIAL, COLLATERAL, INDIRECT, PUNITIVE, INCIDENTAL, CONSEQUENTIAL, OR EXEMPLARY DAMAGES IN CONNECTION WITH OR ARISING OUT OF THESE TERMS AND CONDITIONS OR THE USE OF THE EVMS PROVIDED HEREUNDER, REGARDLESS OF WHETHER TI HAS BEEN ADVISED OF THE POSSIBILITY OF SUCH DAMAGES. EXCLUDED DAMAGES INCLUDE, BUT ARE NOT LIMITED TO, COST OF REMOVAL OR REINSTALLATION, ANCILLARY COSTS TO THE PROCUREMENT OF SUBSTITUTE GOODS OR SERVICES, RETESTING, OUTSIDE COMPUTER TIME, LABOR COSTS, LOSS OF GOODWILL, LOSS OF PROFITS, LOSS OF SAVINGS, LOSS OF USE, LOSS OF DATA, OR BUSINESS INTERRUPTION. NO CLAIM, SUIT OR ACTION SHALL BE BROUGHT AGAINST TI MORE THAN ONE YEAR AFTER THE RELATED CAUSE OF ACTION HAS OCCURRED.
- 8.2 *Specific Limitations.* IN NO EVENT SHALL TI'S AGGREGATE LIABILITY FROM ANY WARRANTY OR OTHER OBLIGATION ARISING OUT OF OR IN CONNECTION WITH THESE TERMS AND CONDITIONS, OR ANY USE OF ANY TI EVM PROVIDED HEREUNDER, EXCEED THE TOTAL AMOUNT PAID TO TI FOR THE PARTICULAR UNITS SOLD UNDER THESE TERMS AND CONDITIONS WITH RESPECT TO WHICH LOSSES OR DAMAGES ARE CLAIMED. THE EXISTENCE OF MORE THAN ONE CLAIM AGAINST THE PARTICULAR UNITS SOLD TO USER UNDER THESE TERMS AND CONDITIONS SHALL NOT ENLARGE OR EXTEND THIS LIMIT.
9. *Return Policy.* Except as otherwise provided, TI does not offer any refunds, returns, or exchanges. Furthermore, no return of EVM(s) will be accepted if the package has been opened and no return of the EVM(s) will be accepted if they are damaged or otherwise not in a resalable condition. If User feels it has been incorrectly charged for the EVM(s) it ordered or that delivery violates the applicable order, User should contact TI. All refunds will be made in full within thirty (30) working days from the return of the components(s), excluding any postage or packaging costs.
10. *Governing Law:* These terms and conditions shall be governed by and interpreted in accordance with the laws of the State of Texas, without reference to conflict-of-laws principles. User agrees that non-exclusive jurisdiction for any dispute arising out of or relating to these terms and conditions lies within courts located in the State of Texas and consents to venue in Dallas County, Texas. Notwithstanding the foregoing, any judgment may be enforced in any United States or foreign court, and TI may seek injunctive relief in any United States or foreign court.

Mailing Address: Texas Instruments, Post Office Box 655303, Dallas, Texas 75265
Copyright © 2015, Texas Instruments Incorporated

IMPORTANT NOTICE

Texas Instruments Incorporated and its subsidiaries (TI) reserve the right to make corrections, enhancements, improvements and other changes to its semiconductor products and services per JESD46, latest issue, and to discontinue any product or service per JESD48, latest issue. Buyers should obtain the latest relevant information before placing orders and should verify that such information is current and complete. All semiconductor products (also referred to herein as "components") are sold subject to TI's terms and conditions of sale supplied at the time of order acknowledgment.

TI warrants performance of its components to the specifications applicable at the time of sale, in accordance with the warranty in TI's terms and conditions of sale of semiconductor products. Testing and other quality control techniques are used to the extent TI deems necessary to support this warranty. Except where mandated by applicable law, testing of all parameters of each component is not necessarily performed.

TI assumes no liability for applications assistance or the design of Buyers' products. Buyers are responsible for their products and applications using TI components. To minimize the risks associated with Buyers' products and applications, Buyers should provide adequate design and operating safeguards.

TI does not warrant or represent that any license, either express or implied, is granted under any patent right, copyright, mask work right, or other intellectual property right relating to any combination, machine, or process in which TI components or services are used. Information published by TI regarding third-party products or services does not constitute a license to use such products or services or a warranty or endorsement thereof. Use of such information may require a license from a third party under the patents or other intellectual property of the third party, or a license from TI under the patents or other intellectual property of TI.

Reproduction of significant portions of TI information in TI data books or data sheets is permissible only if reproduction is without alteration and is accompanied by all associated warranties, conditions, limitations, and notices. TI is not responsible or liable for such altered documentation. Information of third parties may be subject to additional restrictions.

Resale of TI components or services with statements different from or beyond the parameters stated by TI for that component or service voids all express and any implied warranties for the associated TI component or service and is an unfair and deceptive business practice. TI is not responsible or liable for any such statements.

Buyer acknowledges and agrees that it is solely responsible for compliance with all legal, regulatory and safety-related requirements concerning its products, and any use of TI components in its applications, notwithstanding any applications-related information or support that may be provided by TI. Buyer represents and agrees that it has all the necessary expertise to create and implement safeguards which anticipate dangerous consequences of failures, monitor failures and their consequences, lessen the likelihood of failures that might cause harm and take appropriate remedial actions. Buyer will fully indemnify TI and its representatives against any damages arising out of the use of any TI components in safety-critical applications.

In some cases, TI components may be promoted specifically to facilitate safety-related applications. With such components, TI's goal is to help enable customers to design and create their own end-product solutions that meet applicable functional safety standards and requirements. Nonetheless, such components are subject to these terms.

No TI components are authorized for use in FDA Class III (or similar life-critical medical equipment) unless authorized officers of the parties have executed a special agreement specifically governing such use.

Only those TI components which TI has specifically designated as military grade or "enhanced plastic" are designed and intended for use in military/aerospace applications or environments. Buyer acknowledges and agrees that any military or aerospace use of TI components which have **not** been so designated is solely at the Buyer's risk, and that Buyer is solely responsible for compliance with all legal and regulatory requirements in connection with such use.

TI has specifically designated certain components as meeting ISO/TS16949 requirements, mainly for automotive use. In any case of use of non-designated products, TI will not be responsible for any failure to meet ISO/TS16949.

Products

Audio	www.ti.com/audio
Amplifiers	amplifier.ti.com
Data Converters	dataconverter.ti.com
DLP® Products	www.dlp.com
DSP	dsp.ti.com
Clocks and Timers	www.ti.com/clocks
Interface	interface.ti.com
Logic	logic.ti.com
Power Mgmt	power.ti.com
Microcontrollers	microcontroller.ti.com
RFID	www.ti-rfid.com
OMAP Applications Processors	www.ti.com/omap
Wireless Connectivity	www.ti.com/wirelessconnectivity

Applications

Automotive and Transportation	www.ti.com/automotive
Communications and Telecom	www.ti.com/communications
Computers and Peripherals	www.ti.com/computers
Consumer Electronics	www.ti.com/consumer-apps
Energy and Lighting	www.ti.com/energy
Industrial	www.ti.com/industrial
Medical	www.ti.com/medical
Security	www.ti.com/security
Space, Avionics and Defense	www.ti.com/space-avionics-defense
Video and Imaging	www.ti.com/video

TI E2E Community

e2e.ti.com