

CC256xCQFN-EM

Contents

1	Introduction to the CC256xCQFN-EM Board	2
2	Module Description	4
3	Module Detailed Description	5
4	Module Dimensions	10
5	Tools and Software	11
6	Certification.....	12
7	Life Support Policy	12
8	Related Documents	12

List of Figures

1	CC256xCQFN-EM Board	2
2	CC2564xCQFN-EM Highlights.....	4
3	CC256xCQFN-EM Block Diagram	5
4	CC256XCQFN-EM PCM Role Selection for RF Connectors	7
5	COM Connector Pinout	8
6	CC256XCQFN-EM Hardware Modifications for COM Connector	9
7	CC256xC Clocking Scheme	10
8	CC256xCQFN-EM Hardware Configuration	11

List of Tables

1	Jumper Configuration	5
2	RF1	6
3	RF2	6
4	DEBUG HDR	7
5	COM CARD	8
6	Module Dimensions	10

Trademarks

Code Composer Studio is a trademark of Texas Instruments.
 Bluetooth is a registered trademark of Bluetooth SIG, Inc.
 All other trademarks are the property of their respective owners.

1 Introduction to the CC256xCQFN-EM Board

This user's guide is intended for use with TI's Bluetooth® development platform, the CC256xCQFN-EM board (see [Figure 1](#)). This guide helps users quickly get started integrating the board with TI's evaluation platforms and software SDKs. In addition, this user's guide describes the components and configurations of the board so that users can quickly get started using it for various Bluetooth applications.

This guide provides information about the module so that developers can use the board specifics to apply it to their applications. Module information and capabilities, including pin descriptions as well as available software and tools, enhance the user's out-of-box experience.

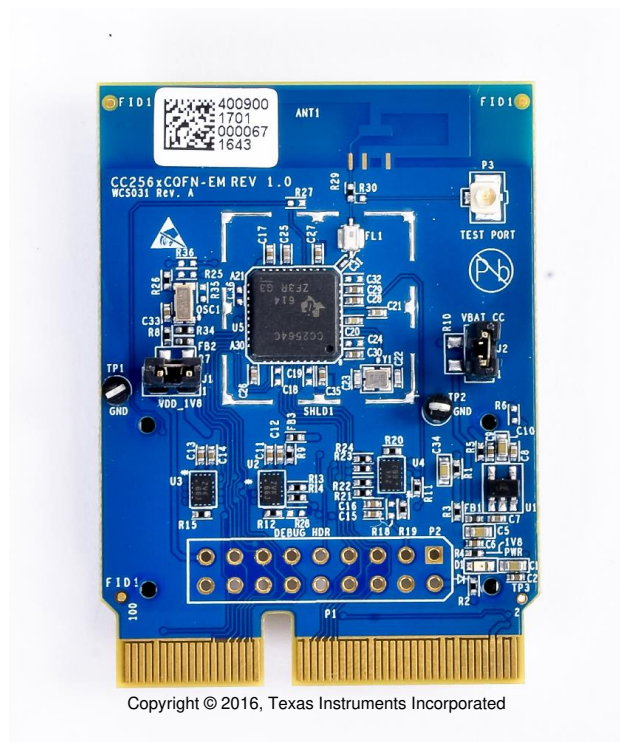

Figure 1. CC256xCQFN-EM Board

1.1 Key Features

- Bluetooth specification 4.1 / 4.2
- Fast time to market
- Easy PCB layout using cadence tools
- 4-layer PCB design
- Bluetooth and Bluetooth low energy
- TI's Bluetooth royalty-free stack with profiles
- FCC, IC, and Bluetooth SIG compliant
- High sensitivity (–93 dBm typical)
- Shield enabled for immunity
- H4 UART and PCM/I2S interface

1.2 QFN EM Board Applications

The following are example embedded wireless applications:

- Wireless Audio Solutions
- mPOS
- Medical Devices
- Set-Top Boxes (STBs)
- Wearable Devices
- Sensor Hub, Sensor Gateway
 - Home and Factory Automation

2 Module Description

The CC256xC QFN EM board is the development environment for the CC256x family and plugs into TI's MSP432™ LaunchPad™ through the BOOST-CCEMADAPTER board.

This family is based on TI's CC256xC integrated circuit and uses a host controller interface (HCI), a cost-effective and flexible means for implementing a Bluetooth network. The HCI reduces BOM cost by eliminating redundant processing capacity and gives designers the flexibility to work with a controller of their choice, because the Bluetooth stack resides and executes on the host processor of the application. [Figure 2](#) highlights various aspects of the CC256xCQFN-EM board.

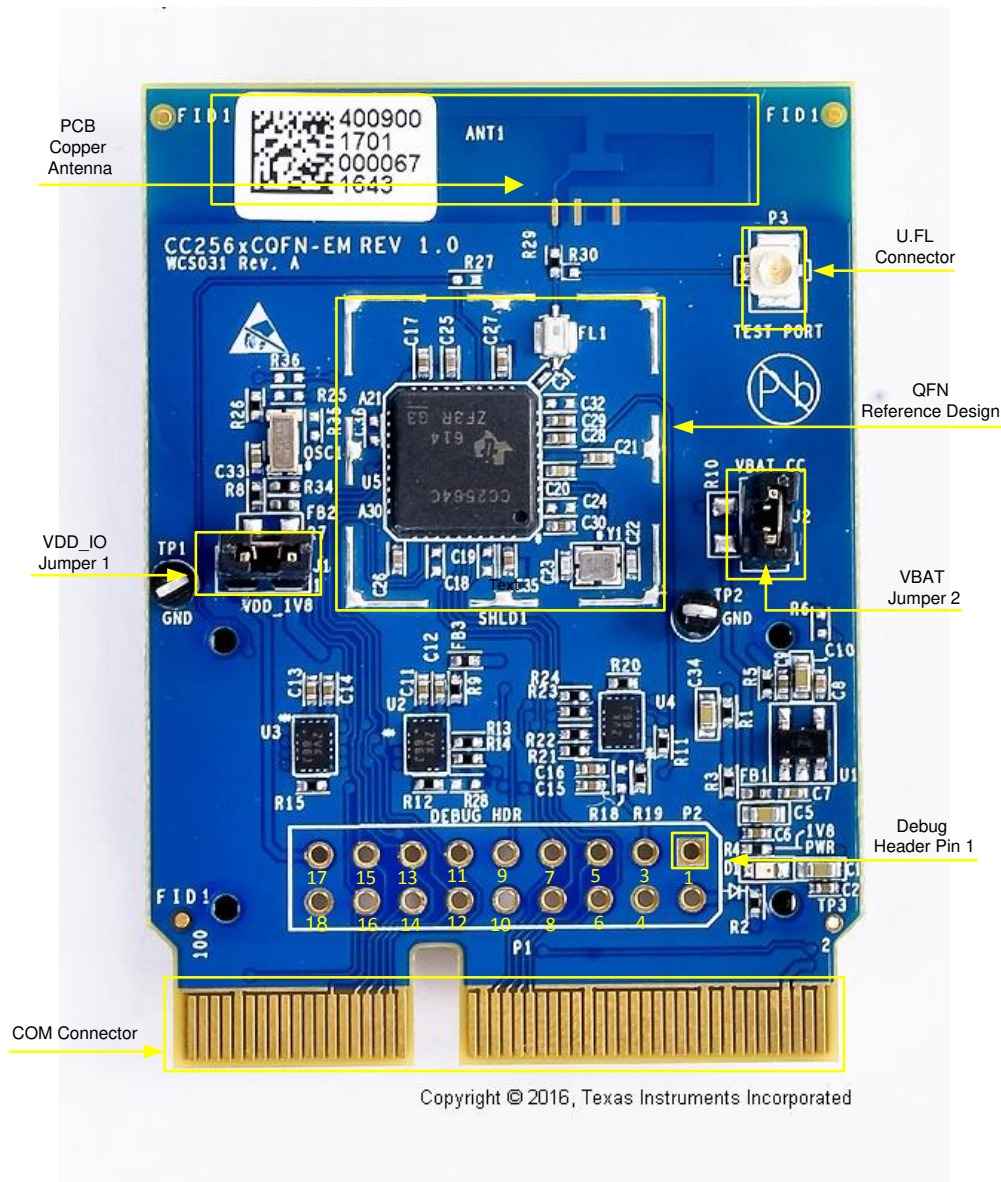

Figure 2. CC2564xCQFN-EM Highlights

The CC256xCQFN-EM board is intended for evaluation purposes and works with TI's Hardware Development Kit. See [Section 6](#) for more information.

To help implement this reference design, schematics and layout files are available on the [CC256x Main Wiki page](#).

3 Module Detailed Description

The reference files including schematics, layout, and BOM for the CC256xCQFN-EM board can be found at: [CC256xCQFN-EM Reference Design](#).

Figure 3 shows a block diagram depicting the I/Os of the QFN board that are required for interfacing to the host controller. These I/Os can be interfaced to the host controller through either the COM connector or the RF1 and RF2 sockets.

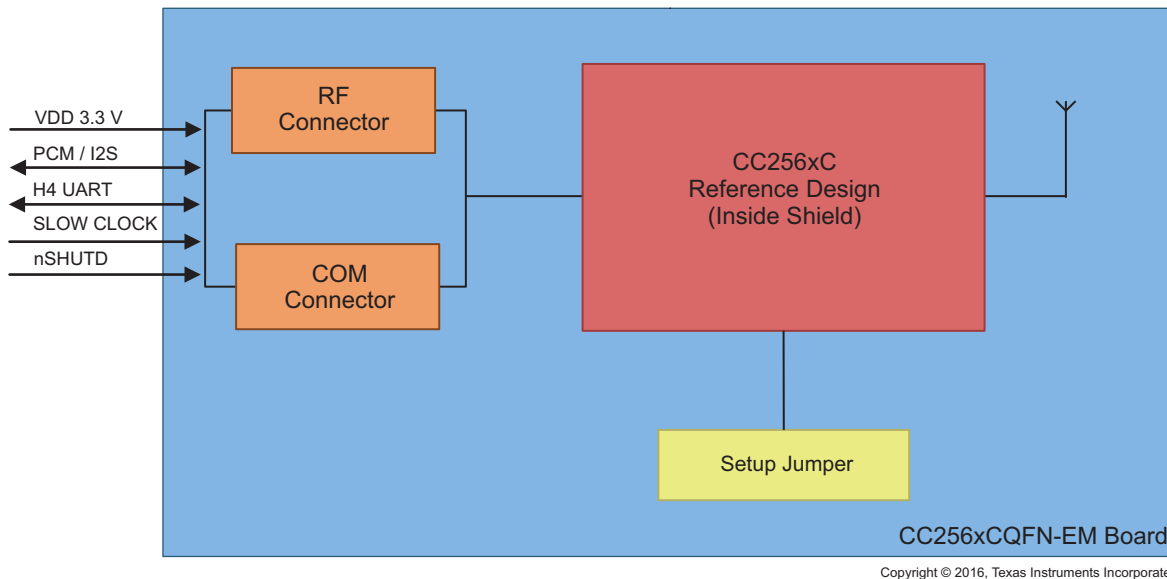

Figure 3. CC256xCQFN-EM Block Diagram

3.1 Pin Description

3.1.1 Board Jumpers

For correct operation, ensure both jumpers are placed for connecting power to the device as follows in [Table 1](#).

Table 1. Jumper Configuration

Jumper	Description
VBAT_CC	Main power supply for CC256xC
VDD_1V8	Supplies power to CC256xC I/Os

3.1.1.1 Measuring Current Consumption

These jumpers can also be used to measure the current consumption by placing current sense resistors on R10 for VBAT_CC and on R7 for VDD_1V8. Both these resistors are 0.10 Ω , 1/4 W. The VBAT_CC jumper can be used to measure the voltage and power consumed by the CC256xC, including RF TX and RX while the VDD_IO jumper can be used to measure voltage and power consumed by the digital I/Os.

3.1.2 Antenna and U.FL Selector

The board can be configured to route the RF output from the CC256xC to the onboard copper antenna or the onboard U.FL connector. This configuration is done by placing the resistor in either the R29 or R30 position which has negligible resistance of 0 Ω . R30 connects the RF to the U.FL while R29 connects to the copper antenna. The U.FL connector is used for conducted testing of the RF. The [Bluetooth Hardware Evaluation Tool \(BHET\)](#) can be used to test basic RF functionality on this board.

3.1.3 RF Connectors

The RF1 and RF2 connectors can be used to mount the TI MSP432 platform using the BOOST-CCEMADAPTER board. The RF I/Os are all at 3.3-V levels; this enables seamless integration of the host using TI's platforms that come preinstalled with EM headers. [Table 2](#) and [Table 3](#) describe the standard pinout.

Table 2. RF1

Pin No.	EM Adapter Pin Assignment	Pin No.	EM Adapter Pin Assignment
1	GND	2	NC
3	MODULE_UART_CTS	4	NC
5	SLOW_CLK	6	NC
7	MODULE_UART_RX	8	NC
9	MODULE_UART_TX	10	NC
11	NC (not connected)	12	NC
13	NC	14	NC
15	NC	16	NC
17	NC	18	NC
19	GND	20	NC

Table 3. RF2

Pin No.	EM Adapter Pin Assignment	Pin No.	EM Adapter Pin Assignment
1	NC	2	GND
3	NC	4	NC
5	NC	6	NC
7	3.3 V	8	MODULE_AUDIO_DATA_OUT
9	3.3 V	10	MODULE_AUDIO_DATA_IN
11	MODULE_AUDIO_FSYNC	12	NC
13	NC	14	NC
15	NC	16	NC
17	MODULE_AUDIO_CLK	18	MODULE_UART_RTS
19	WCS_NSHUTD	20	NC

For complete evaluation of the audio applications while using the RF connectors (a.k.a. EM connectors), the level shifter U4 must be properly configured in order to ensure proper direction of PCM signals.

- When using CC256XC as PCM master role,
 - R19 must be populated with 10K Ω resistor.
 - R18 and R11 must be unpopulated (removed).
- When using CC256XC as PCM slave,
 - R18 must be populated with 0 Ω resistor.
 - R19 and R11 must be unpopulated (removed).

More information on the hardware changes required for PCM signals on EM connectors can be found in the [CC256XCQFN-EM board design files](#) (schematics and bill of materials).

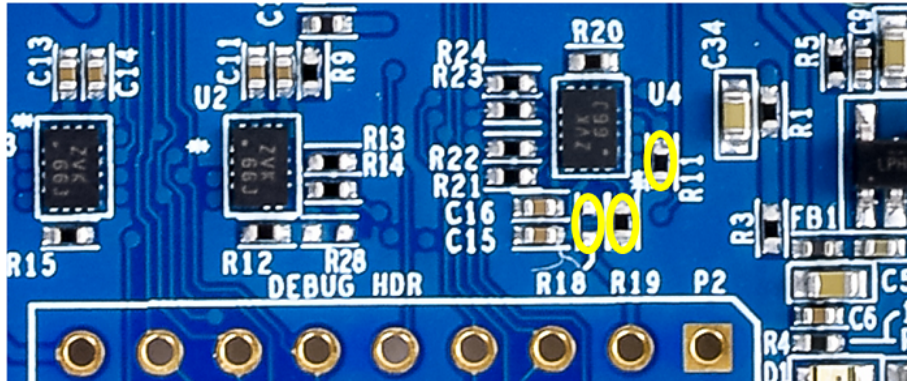

Figure 4. CC256XCQFN-EM PCM Role Selection for RF Connectors

3.1.4 Debug Header

The debug header is provided for testing and debugging purposes. The debug header exposes important signals used in the design such as power, ground, debug, UART, and audio signals. All I/Os are at 1.8 V. [Table 4](#) shows the pinout.

Table 4. DEBUG HDR

Pin No.	EM Adapter Pin Assignment	Pin No.	EM Adapter Pin Assignment
1	GND	2	VBAT
3	VIO_HOST	4	GND
5	AUD_FSYNC_1V8	6	AUD_CLK_1V8
7	AUD_OUT_1V8	8	AUD_IN_1V8
9	CLK_REQ_OUT_1V8	10	SLOW_CLK_EDGE
11	HCI_TX_1V8	12	HCI_RX_1V8
13	HCI_CTS_1V8	14	HCI_RTS_1V8
15	TX_DEBUG_1V8	16	nSHUTDOWN_1V8
17	VDD_1V8	18	GND

3.1.5 COM Connector

The COM connector, or edge card, is used to interface with TI's MPUs such as the AM437x and AM335x EVMs. As shown in Figure 5, the COM connector provides HCI, audio, slow clock, shutdown, and debug interfaces to the host connected through the edge card. All I/Os for the COM connector are at 1.8 V. Some components must be DNI to use the COM connector. See the BOM for details.

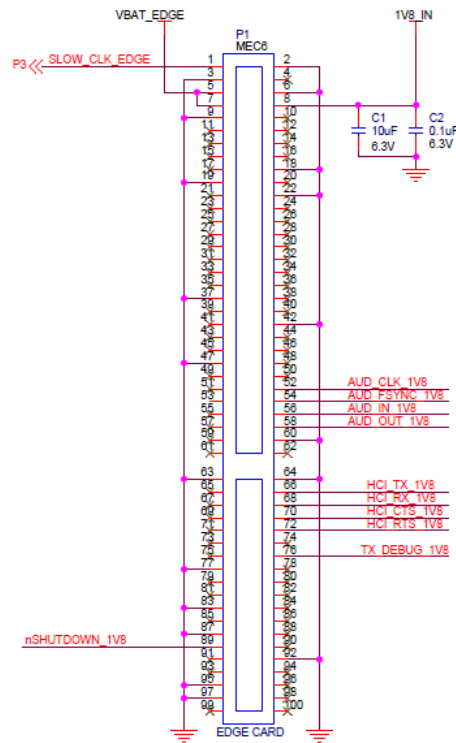

Figure 5. COM Connector Pinout

Table 5 lists the COM card pinout.

Table 5. COM CARD

Pin No.	Relevant COM Connector Pin Assignment
1	SLOW_CLK_EDGE
8	1V8_IN
52	AUD_CLK_1V8
54	AUD_FSYNC_1V8
56	AUD_IN_1V8
58	AUD_OUT_1V8
66	HCI_TX_1V8
68	HCI_RX_1V8
70	HCI_CTS_1V8
72	HCI_RTS_1V8
76	TX_DEBUG_1V8
89	nSHUTDOWN_1V8

Pins 3, 9, 19, 37, 47, 63, 77, 83, 87, 95, and 97, as well as 2, 6, 18, 22, 42, 60, 64, and 92 are connected to ground.

All other pins are NC.

Some components must be removed (DNI) and R2 must be populated on the CC256XCQFN-EM to use the COM connector with the AM335x evaluation module (TMDXEVM3358) or similar Sitara EVM.

- EM1, EM2, U2, U3, and U4 must be unpopulated (removed).
- R2 (0 Ω) must be populated.

More information on the hardware changes required for the COM connector are in the [CC256XCQFN-EM board design files](#) (schematics and bill of materials).

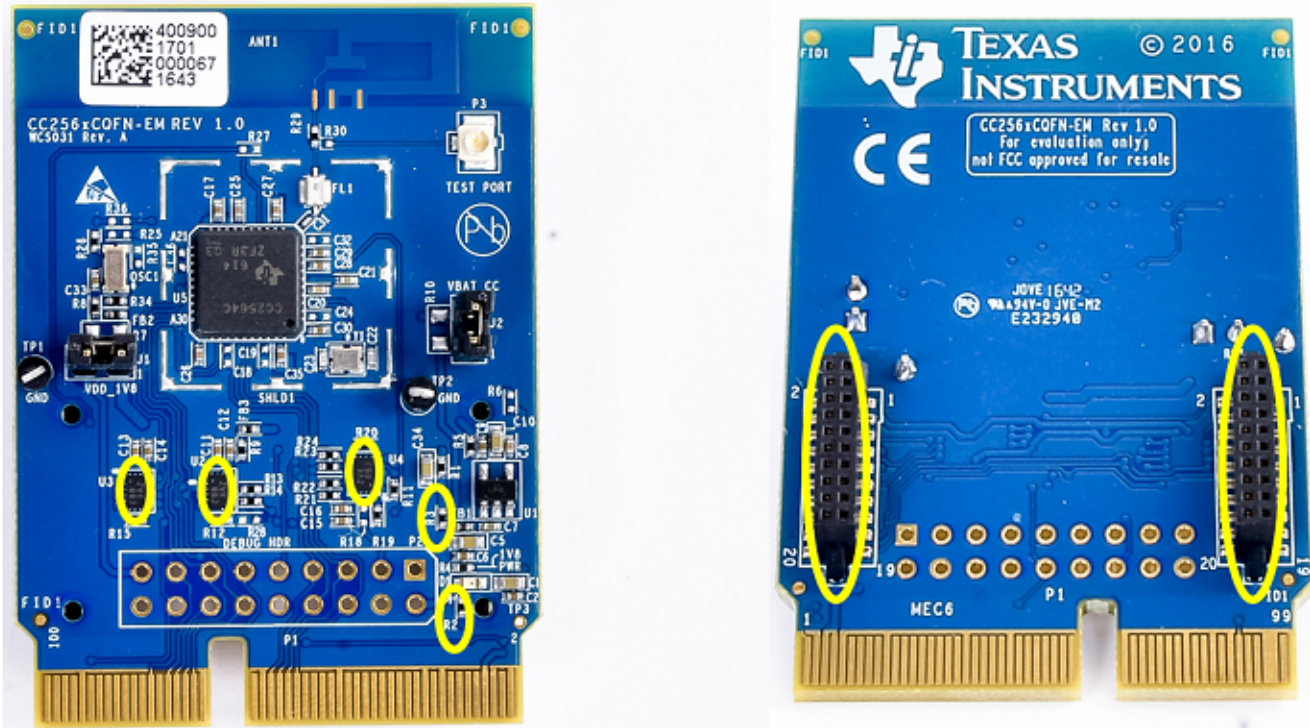

Figure 6. CC256XCQFN-EM Hardware Modifications for COM Connector

3.2 Clock Inputs

The slow clock can come from two sources, internal and external to the board. The CC256xCQFN-EM has the option to place the slow clock on the board or source it from an external source. The source is connected to the SLOW_CLK_IN (see [Figure 7](#)) and can be a digital signal in the range of 0 to 1.8 V.

The frequency accuracy of the slow clock must be 32.768 kHz and ± 250 ppm for Bluetooth use (according to the Bluetooth specification).

When the MSP432 Launchpad is connected, the SLOW_CLK_IN signal, is sourced from the oscillator on the CC256xCQFN-EM board, therefore no additional clock source is needed.

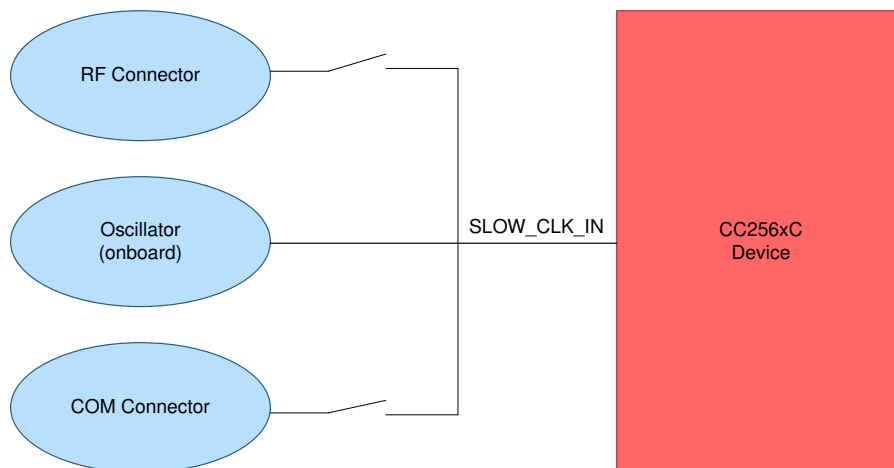

Figure 7. CC256xC Clocking Scheme

4 Module Dimensions

[Table 6](#) lists the module dimensions.

Table 6. Module Dimensions

No.	Item	Dimension (in)	Tolerance	Remark
1	Width	1.550	± 0.001	Smaller at COM end
2	Length	2.125	± 0.001	—
3	Height	0.062	± 0.001	—

5 Tools and Software

5.1 TI's Bluetooth® Software Solution

The Bluetooth software based solution is based on TI's Bluetooth stack, such as the CC2564CMSP432BTBLESW. Detailed documentation is in the previous SDK.

5.2 Evaluation Platforms

TI supports the MSP432 LaunchPad (MSP-EXP432P401R).

In addition, a software development environment, for example Code Composer Studio™, is required. For a detailed description on use of these tools, refer to the [CC256xC EVM Platform](#). Evaluation kits and modules are available through TI's network of authorized distributors.

[Figure 8](#) shows the CC256xCQFN-EM board mounted to the MSP-EXP432P401R using the BOOST-CCEMADAPTER board, which uses the RF1 and RF2 interface board.

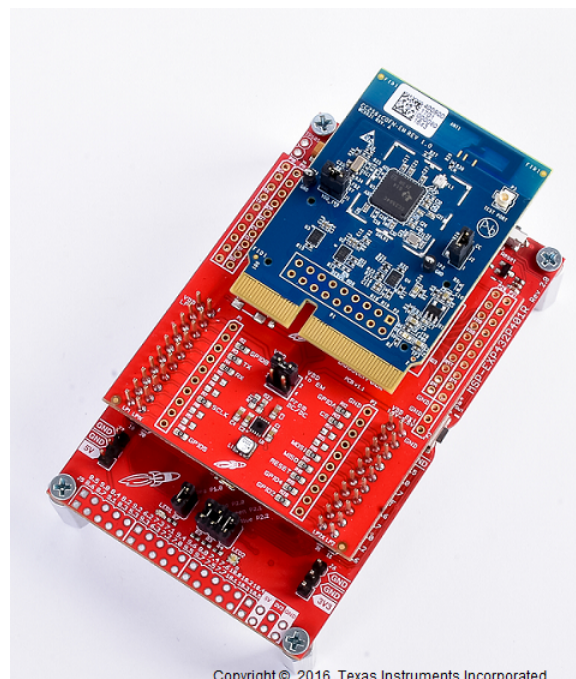

Figure 8. CC256xCQFN-EM Hardware Configuration

5.3 Bluetooth® Hardware Evaluation Tool

The [CC256x Bluetooth Hardware Evaluation Tool](#) can be downloaded as a complete package from TI. This program is an intuitive, user-friendly tool to test TI's Bluetooth chips including this CC256xCQFN-EM board. More specifically, the program is used to measure RF performance of TI's Bluetooth chips.

6 Certification

Certifications for the CC256xCQFN-EM board include the CE Mark - Conformité Européenne. The CC256xC is also in the process of being certified as a Bluetooth controller subsystem by Bluetooth SIG (Special Interest Group).

NOTE: This device is an engineering development board and cannot be used in an end product.

7 Life Support Policy

CAUTION

This TI product is not designed for use in life support appliances, devices, or systems where malfunction can reasonably be expected to result in a significant personal injury to the user, or as a critical component in any life support device or system whose failure to perform can be reasonably expected to cause the failure of the life support device or system, or to affect its safety or effectiveness. TI customers using or selling these products for use in such applications do so at their own risk and agree to fully indemnify TI for any damages resulting.

8 Related Documents

- [CC2564C Data Sheet](#)
- [CC256x System Design Guide](#)
- [CC256xQFN PCB Guidelines](#)
- [QFN Reference Design](#)

Revision History

NOTE: Page numbers for previous revisions may differ from page numbers in the current version.

Changes from November 15, 2016 to March 10, 2020 (from A Revision (November 2016) to B Revision)	Page
• Corrected R18, R19, and R11 resistor configurations.....	6

IMPORTANT NOTICE AND DISCLAIMER

TI PROVIDES TECHNICAL AND RELIABILITY DATA (INCLUDING DATASHEETS), DESIGN RESOURCES (INCLUDING REFERENCE DESIGNS), APPLICATION OR OTHER DESIGN ADVICE, WEB TOOLS, SAFETY INFORMATION, AND OTHER RESOURCES "AS IS" AND WITH ALL FAULTS, AND DISCLAIMS ALL WARRANTIES, EXPRESS AND IMPLIED, INCLUDING WITHOUT LIMITATION ANY IMPLIED WARRANTIES OF MERCHANTABILITY, FITNESS FOR A PARTICULAR PURPOSE OR NON-INFRINGEMENT OF THIRD PARTY INTELLECTUAL PROPERTY RIGHTS.

These resources are intended for skilled developers designing with TI products. You are solely responsible for (1) selecting the appropriate TI products for your application, (2) designing, validating and testing your application, and (3) ensuring your application meets applicable standards, and any other safety, security, or other requirements. These resources are subject to change without notice. TI grants you permission to use these resources only for development of an application that uses the TI products described in the resource. Other reproduction and display of these resources is prohibited. No license is granted to any other TI intellectual property right or to any third party intellectual property right. TI disclaims responsibility for, and you will fully indemnify TI and its representatives against, any claims, damages, costs, losses, and liabilities arising out of your use of these resources.

TI's products are provided subject to TI's Terms of Sale (www.ti.com/legal/termsofsale.html) or other applicable terms available either on ti.com or provided in conjunction with such TI products. TI's provision of these resources does not expand or otherwise alter TI's applicable warranties or warranty disclaimers for TI products.

Mailing Address: Texas Instruments, Post Office Box 655303, Dallas, Texas 75265
Copyright © 2020, Texas Instruments Incorporated