

CDC2516

3.3-V PHASE-LOCK LOOP CLOCK DRIVER

SCAS579C – OCTOBER 1996 – REVISED DECEMBER 2004

- Use **CDCVF2510A** as a Replacement for this Device
- Phase-Lock Loop Clock Distribution for Synchronous DRAM Applications
- Distributes One Clock Input to Four Banks of Four Outputs
- Separate Output Enable for Each Output Bank
- External Feedback Pin (FBIN) Is Used to Synchronize the Outputs to the Clock Input
- On-Chip Series-Damping Resistors
- No External RC Network Required
- Operates at 3.3-V V_{CC}
- Packaged in Plastic 48-Pin Thin Shrink Small-Outline Package

description

The CDC2516 is a high-performance, low-skew, low-jitter, phase-lock loop (PLL) clock driver. It uses a PLL to precisely align, in both frequency and phase, the feedback output (FBOUT) to the clock (CLK) input signal. It is specifically designed for use with synchronous DRAMs. The CDC2516 operates at 3.3-V V_{CC} and provides integrated series-damping resistors that make it ideal for driving point-to-point loads.

Four banks of four outputs provide 16 low-skew, low-jitter copies of the input clock. Output signal duty cycles are adjusted to 50 percent, independent of the duty cycle at the input clock. Each bank of outputs can be enabled or disabled separately via the 1G, 2G, 3G, and 4G control inputs. When the G inputs are high, the outputs switch in phase and frequency with CLK; when the G inputs are low, the outputs are disabled to the logic-low state.

Unlike many products containing PLLs, the CDC2516 does not require external RC networks. The loop filter for the PLL is included on-chip, minimizing component count, board space, and cost.

Because it is based on PLL circuitry, the CDC2516 requires a stabilization time to achieve phase lock of the feedback signal to the reference signal. This stabilization time is required following power up and application of a fixed-frequency, fixed-phase signal at CLK, as well as following any changes to the PLL reference or feedback signals. The PLL may be bypassed for test purposes by strapping AV_{CC} to ground.

The CDC2516 is characterized for operation from 0°C to 70°C.

**DGG PACKAGE
(TOP VIEW)**

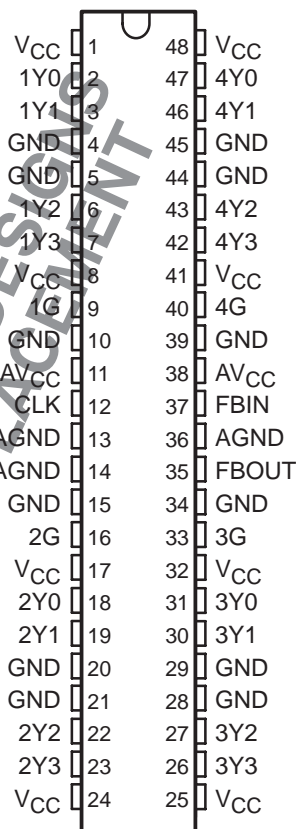

Please be aware that an important notice concerning availability, standard warranty, and use in critical applications of Texas Instruments semiconductor products and disclaimers thereto appears at the end of this data sheet.

PRODUCTION DATA information is current as of publication date. Products conform to specifications per the terms of Texas Instruments standard warranty. Production processing does not necessarily include testing of all parameters.



POST OFFICE BOX 655303 • DALLAS, TEXAS 75265

Copyright © 2004, Texas Instruments Incorporated

CDC2516

3.3-V PHASE-LOCK LOOP CLOCK DRIVER

SCAS579C – OCTOBER 1996 – REVISED DECEMBER 2004

FUNCTION TABLE

INPUTS					OUTPUTS				
1G	2G	3G	4G	CLK	1Y (0:3)	2Y (0:3)	3Y (0:3)	4Y (0:3)	FBOUT
X	X	X	X	L	L	L	L	L	L
L	L	L	L	H	L	L	L	L	H
L	L	L	H	H	L	L	L	H	H
L	L	H	L	H	L	L	H	L	H
L	L	H	H	H	L	L	H	H	H
L	H	L	L	H	L	H	L	H	H
L	H	L	H	H	L	H	H	H	H
L	H	H	L	H	L	H	H	L	H
L	H	H	H	H	L	H	H	H	H
H	L	L	L	H	H	L	L	L	H
H	L	L	H	H	H	L	L	H	H
H	L	H	L	H	H	L	L	L	H
H	L	H	H	H	H	L	H	H	H
H	H	L	L	H	H	H	L	L	H
H	H	L	H	H	H	H	L	H	H
H	H	H	L	H	H	H	H	L	H
H	H	H	H	H	H	H	H	H	H

AVAILABLE OPTIONS

T _A	PACKAGE
	SMALL OUTLINE (DGG)
0°C to 70°C	CDC2516DGGR

NOT RECOMMENDED FOR NEW DESIGNS
USE CDCVF2516 AS A REPLACEMENT

CDC2516

3.3-V PHASE-LOCK LOOP CLOCK DRIVER

SCAS579C – OCTOBER 1996 – REVISED DECEMBER 2004

functional block diagram

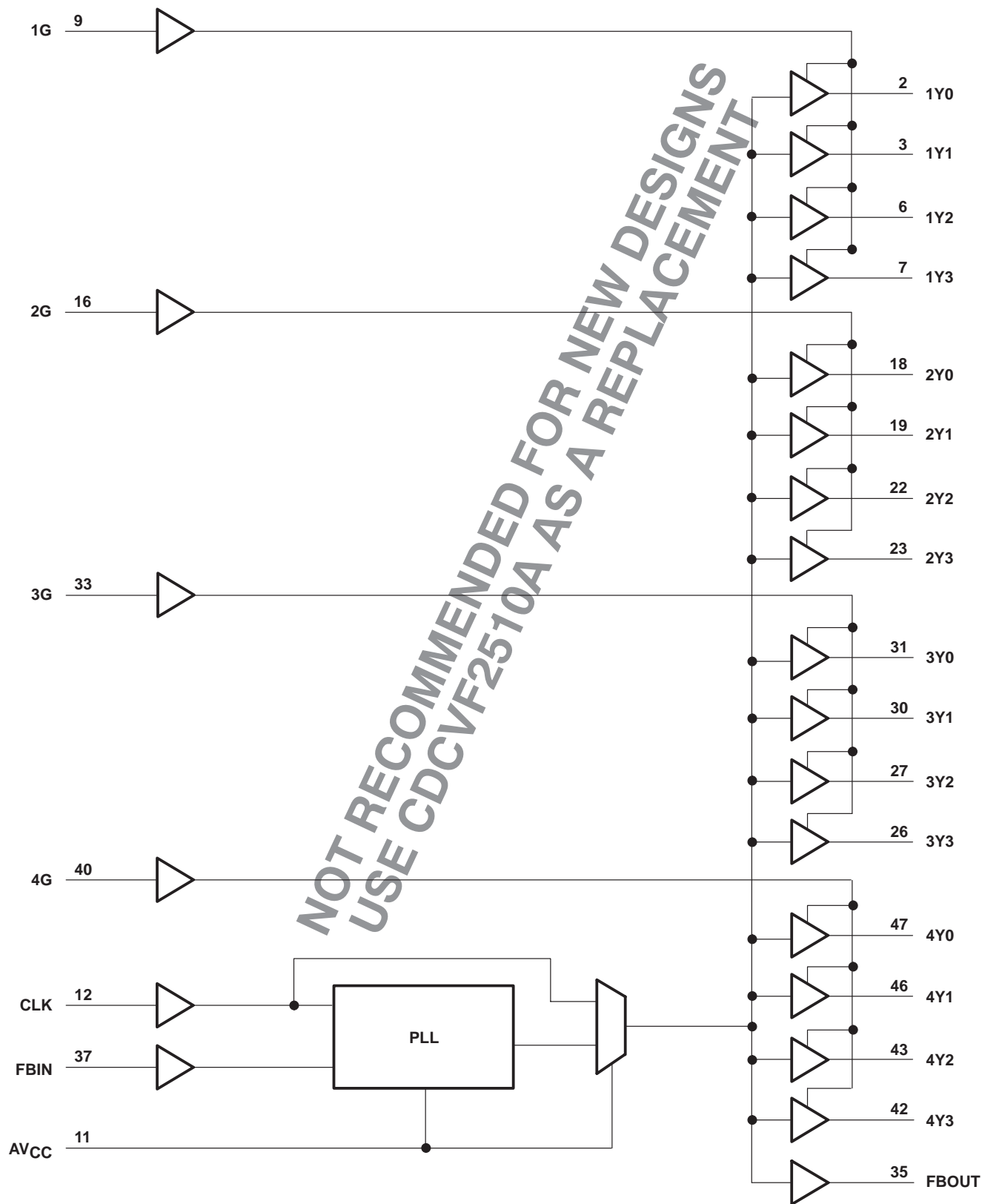

CDC2516

3.3-V PHASE-LOCK LOOP CLOCK DRIVER

SCAS579C – OCTOBER 1996 – REVISED DECEMBER 2004

Terminal Functions

TERMINAL NAME	NO.	TYPE	DESCRIPTION
CLK	12	I	Clock input. CLK provides the clock signal to be distributed by the CDC2516 clock driver. CLK is used to provide the reference signal to the integrated PLL that generates the clock output signals. CLK must have a fixed frequency and fixed phase for the PLL to obtain phase lock. Once the circuit is powered up and a valid CLK signal is applied, a stabilization time is required for the PLL to phase lock the feedback signal to its reference signal.
FBIN	37	I	Feedback input. FBIN provides the feedback signal to the internal PLL. FBIN must be hard-wired to FBOUT to complete the PLL. The integrated PLL synchronizes CLK and FBIN so that there is nominally zero phase error between CLK and FBIN.
1G	9	I	Output bank enable. 1G is the output enable for outputs 1Y(0:3). When 1G is low, outputs 1Y(0:3) are disabled to a logic-low state. When 1G is high, all outputs 1Y(0:3) are enabled and switch at the same frequency as CLK.
2G	16	I	Output bank enable. 2G is the output enable for outputs 2Y(0:3). When 2G is low, outputs 2Y(0:3) are disabled to a logic-low state. When 2G is high, all outputs 2Y(0:3) are enabled and switch at the same frequency as CLK.
3G	33	I	Output bank enable. 3G is the output enable for outputs 3Y(0:3). When 3G is low, outputs 3Y(0:3) are disabled to a logic-low state. When 3G is high, all outputs 3Y(0:3) are enabled and switch at the same frequency as CLK.
4G	40	I	Output bank enable. 4G is the output enable for outputs 4Y(0:3). When 4G is low, outputs 4Y(0:3) are disabled to a logic-low state. When 4G is high, all outputs 4Y(0:3) are enabled and switch at the same frequency as CLK.
FBOUT	35	O	Feedback output. FBOUT is dedicated for external feedback. It switches at the same frequency as CLK. When externally wired to FBIN, FBOUT completes the feedback loop of the PLL. FBOUT has an integrated 25-Ω series-damping resistor.
1Y(0:3)	2, 3, 6, 7	O	Clock outputs. These outputs provide low-skew copies of CLK. Outputs 1Y(0:3) are enabled via 1G. These outputs can be disabled to a logic-low state by deasserting the 1G control input. Each output has an integrated 25-Ω series-damping resistor.
2Y(0:3)	18, 19, 22, 23	O	Clock outputs. These outputs provide low-skew copies of CLK. Outputs 2Y(0:3) are enabled via 2G. These outputs can be disabled to a logic-low state by deasserting the 2G control input. Each output has an integrated 25-Ω series-damping resistor.
3Y(0:3)	31, 30, 27, 26	O	Clock outputs. These outputs provide low-skew copies of CLK. Outputs 3Y(0:3) are enabled via 3G. These outputs can be disabled to a logic-low state by deasserting the 3G control input. Each output has an integrated 25-Ω series-damping resistor.
4Y(0:3)	47, 46, 43, 42	O	Clock outputs. These outputs provide low-skew copies of CLK. Outputs 4Y(0:3) are enabled via 4G. These outputs can be disabled to a logic-low state by deasserting the 4G control input. Each output has an integrated 25-Ω series-damping resistor.
AV _{CC}	11, 38	Power	Analog power supply. AV _{CC} provides the power reference for the analog circuitry. In addition, AV _{CC} can be used to bypass the PLL for test purposes. When AV _{CC} is strapped to ground, the PLL is bypassed and CLK is buffered directly to the device outputs.
AGND	13, 14, 36	Ground	Analog ground. AGND provides the ground reference for the analog circuitry.
V _{CC}	1, 8, 17, 24, 25, 32, 41, 48	Power	Power supply
GND	4, 5, 10, 15, 20, 21, 28, 29, 34, 39, 44, 45	Ground	Ground



absolute maximum ratings over operating free-air temperature range (unless otherwise noted)†

Supply voltage range, V_{CC}	-0.5 V to 4.6 V
Input voltage range, V_I (see Note 1)	-0.5 V to 6.5 V
Voltage range applied to any output in the high or low state, V_O (see Notes 1 and 2)	-0.5 V to $V_{CC} + 0.5$ V
Input clamp current, I_{IK} ($V_I < 0$)	-50 mA
Output clamp current, I_{OK} ($V_O < 0$ or $V_O > V_{CC}$)	±50 mA
Continuous output current, I_O ($V_O = 0$ to V_{CC})	±50 mA
Continuous current through each V_{CC} or GND	±100 mA
Maximum power dissipation at $T_A = 55^\circ\text{C}$ (in still air) (see Note 3)	0.85 W
Storage temperature range, T_{stg}	-65°C to 150°C

† Stresses beyond those listed under “absolute maximum ratings” may cause permanent damage to the device. These are stress ratings only, and functional operation of the device at these or any other conditions beyond those indicated under “recommended operating conditions” is not implied. Exposure to absolute-maximum-rated conditions for extended periods may affect device reliability.

- NOTES:
1. The input and output negative-voltage ratings may be exceeded if the input and output clamp-current ratings are observed.
 2. This value is limited to 4.6 V maximum.
 3. The maximum package power dissipation is calculated using a junction temperature of 150°C and a board trace length of 750 mils. For more information, refer to the *Package Thermal Considerations* application note in the *ABT Advanced BiCMOS Technology Data Book*, literature number SCBD002.

recommended operating conditions (see Note 4)

		MIN	MAX	UNIT
V_{CC}	Supply voltage	3	3.6	V
V_{IH}	High-level input voltage	2		V
V_{IL}	Low-level input voltage		0.8	V
V_I	Input voltage	0	V_{CC}	V
I_{OH}	High-level output current		-12	mA
I_{OL}	Low-level output current		12	mA
T_A	Operating free-air temperature	0	70	°C

NOTE 4: Unused inputs must be held high or low to prevent them from floating.

electrical characteristics over recommended operating free-air temperature range (unless otherwise noted)

PARAMETER	TEST CONDITIONS	V_{CC}	MIN	TYP‡	MAX	UNIT
V_{IK}	$I_I = -18$ mA	3 V			-1.2	V
V_{OH}	$I_{OH} = -100$ μ A	MIN to MAX	$V_{CC} - 0.2$			V
	$I_{OH} = -12$ mA	3 V	2.1			
	$I_{OH} = -6$ mA	3 V	2.4			
V_{OL}	$I_{OL} = 100$ μ A	MIN to MAX			0.2	V
	$I_{OL} = 12$ mA	3 V			0.8	
	$I_{OL} = 6$ mA	3 V			0.55	
I_I	$V_I = V_{CC}$ or GND	3.6 V			±5	μ A
$I_{CC}\S$	$V_I = V_{CC}$ or GND $I_O = 0$, Outputs: low or high	3.6 V			20	μ A
ΔI_{CC}	One input at $V_{CC} - 0.6$ V, Other inputs at V_{CC} or GND	3.3 V to 3.6 V			500	μ A
C_i	$V_I = V_{CC}$ or GND	3.3 V		4		pF
C_o	$V_O = V_{CC}$ or GND	3.3 V		6		pF

‡ For conditions shown as MIN or MAX, use the appropriate value specified under recommended operating conditions.

§ For I_{CC} of AV $_{CC}$, see Figure 5. For dynamic digital I_{CC} , see Figure 6.

CDC2516

3.3-V PHASE-LOCK LOOP CLOCK DRIVER

SCAS579C – OCTOBER 1996 – REVISED DECEMBER 2004

timing requirements over recommended ranges of supply voltage and operating free-air temperature

	MIN	MAX	UNIT
f_{clock} Clock frequency	25	125	MHz
Input clock duty cycle	40%	60%	
Stabilization time [†]		1	ms

[†] Time required for the integrated PLL circuit to obtain phase lock of its feedback signal to its reference signal. For phase lock to be obtained, a fixed-frequency, fixed-phase reference signal must be present at CLK. Until phase lock is obtained, the specifications for propagation delay, skew, and jitter parameters given in the switching characteristics table are not applicable.

switching characteristics over recommended ranges of supply voltage and operating free-air temperature, $C_L = 30 \text{ pF}$ (see Note 5 and Figures 1 and 2)[‡]

PARAMETER	FROM (INPUT)	TO (OUTPUT)	$V_{CC} = 3.3 \text{ V} \pm 0.165 \text{ V}$			$V_{CC} = 3.3 \text{ V} \pm 0.3 \text{ V}$			UNIT
			MIN	TYP	MAX	MIN	TYP	MAX	
$t_{\text{phase error reference}}$ (see Figure 3)	66 MHz < CLKIN \uparrow < 100 MHz	FBIN \uparrow				-0.7...0.18			ns
$t_{\text{phase error, - jitter}}$, (see Note 6)	CLKIN \uparrow = 100 MHz	FBIN \uparrow	-360		50	-170			ps
$t_{\text{sk(o)}}$ [§]	Any Y or FBOUT	Any Y or FBOUT						200	ps
Jitter(pk-pk)	F(CLKIN > 66 MHz)	Any Y or FBOUT				-100		100	ps
Duty cycle	F(CLKIN \leq 66 MHz)	Any Y or FBOUT				45%		55%	
	F(CLKIN > 66 MHz)	Any Y or FBOUT				43%		55%	
t_r		Any Y or FBOUT		1.3	1.9	0.7		2.1	ns
t_f		Any Y or FBOUT		1.7	2.5	1.2		2.5	ns

[‡] These parameters are not production tested.

[§] The $t_{\text{sk(o)}}$ specification is only valid for equal loading of all outputs.

NOTES: 5. The specifications for parameters in this table are applicable only after any appropriate stabilization time has elapsed.

6. Phase error does not include jitter. The total phase error is -460 ps to 150 ps for the 5% V_{CC} range.

NOT RECOMMENDED FOR NEW DESIGNS
USE CDCVFP25101 AS A REPLACEMENT



PARAMETER MEASUREMENT INFORMATION

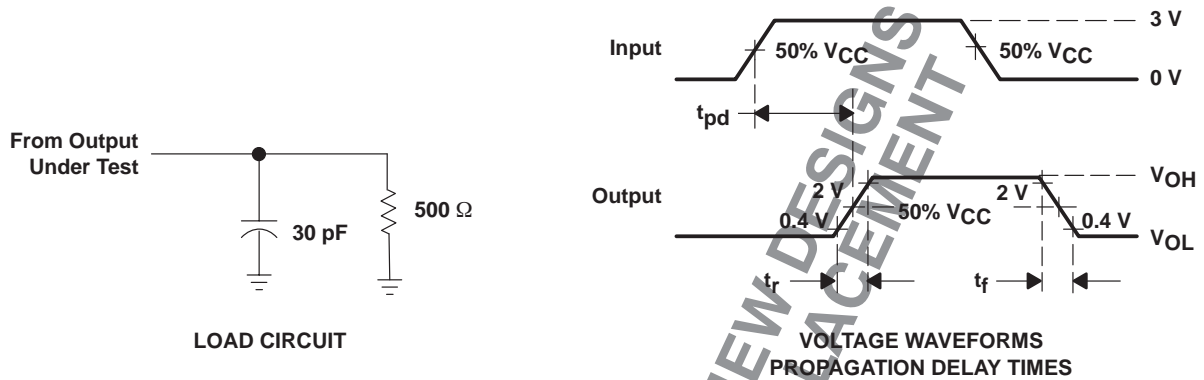

- NOTES: A. C_L includes probe and jig capacitance.
 B. All input pulses are supplied by generators having the following characteristics: $PRR \leq 100$ MHz, $Z_O = 50 \Omega$, $t_r \leq 1.2$ ns, $t_f \leq 1.2$ ns.
 C. The outputs are measured one at a time with one transition per measurement.

Figure 1. Load Circuit and Voltage Waveforms

NOT RECOMMENDED FOR NEW DESIGNS
 USE CDCVF2510A AS A REPLACEMENT

CDC2516

3.3-V PHASE-LOCK LOOP CLOCK DRIVER

SCAS579C – OCTOBER 1996 – REVISED DECEMBER 2004

PARAMETER MEASUREMENT INFORMATION

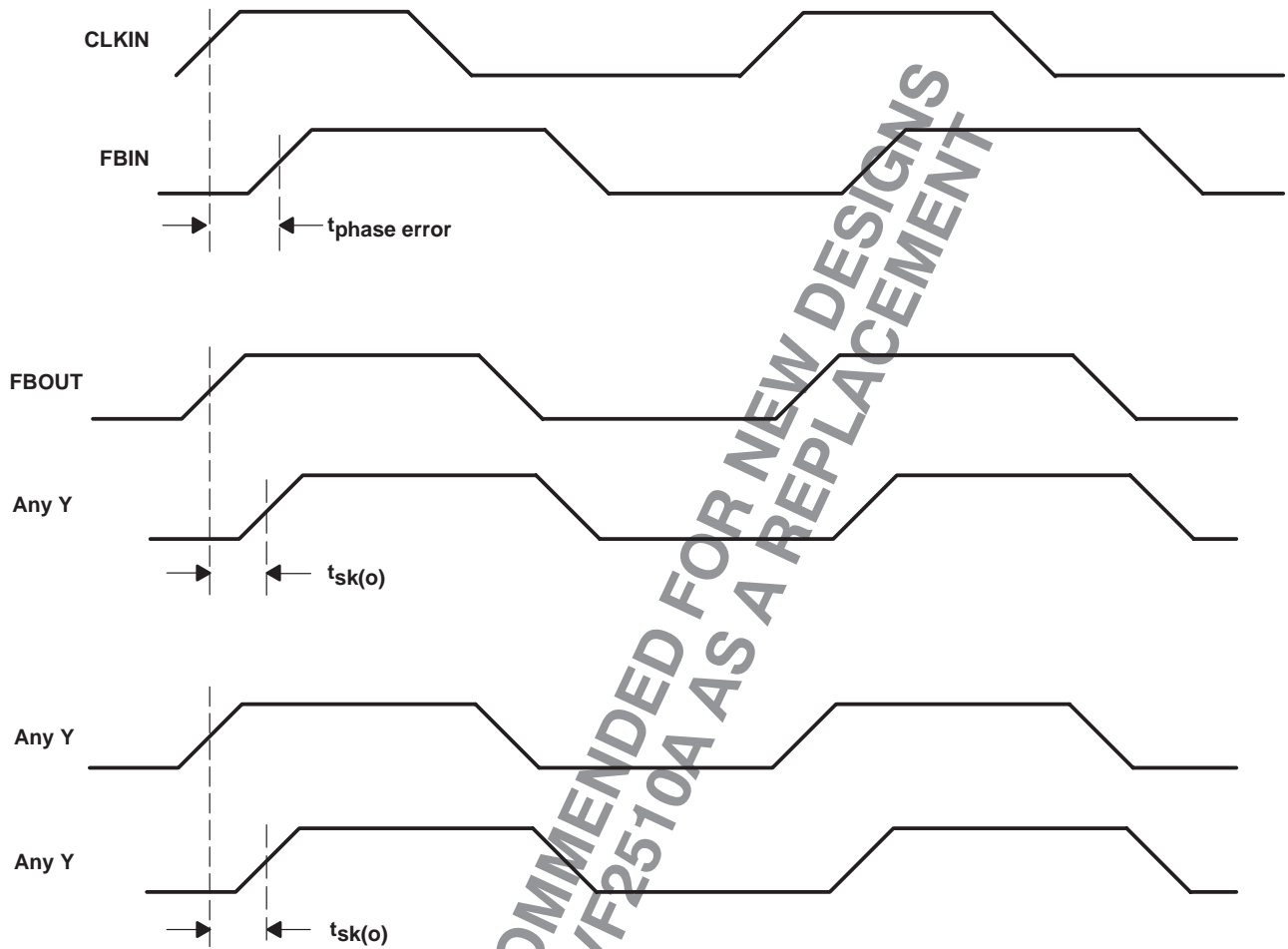

Figure 2. Phase Error and Skew Calculations

TYPICAL CHARACTERISTICS

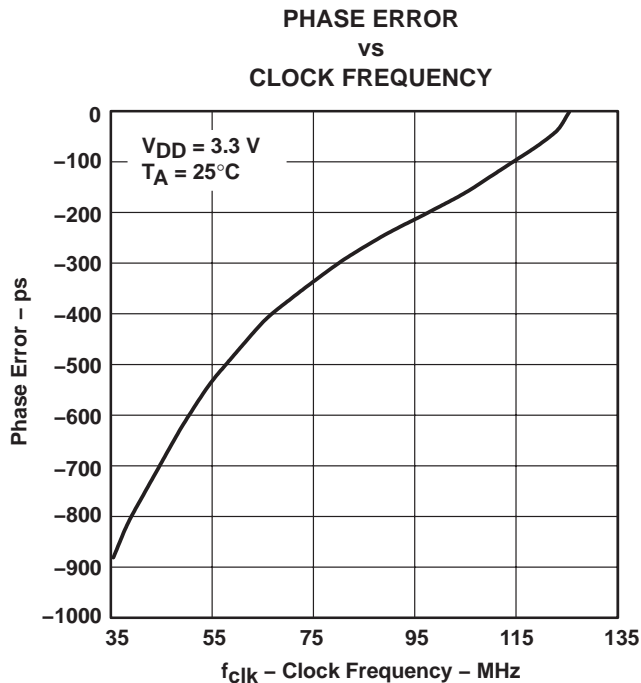

Figure 3

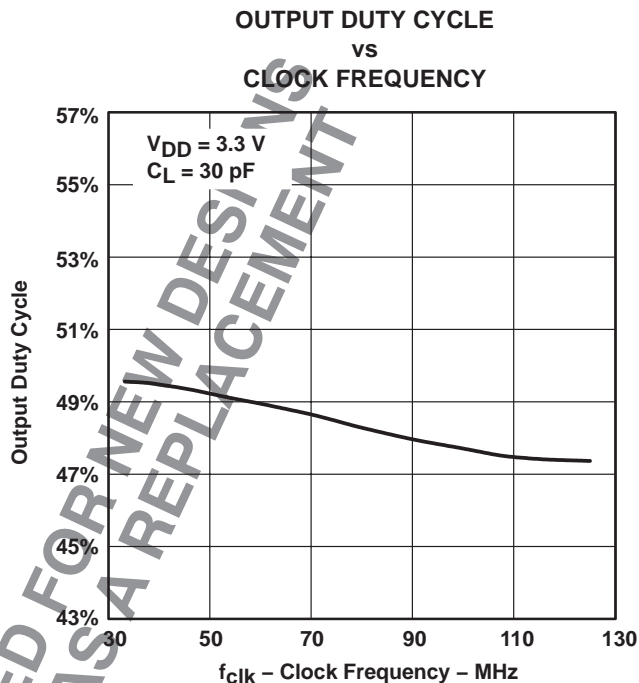

Figure 4

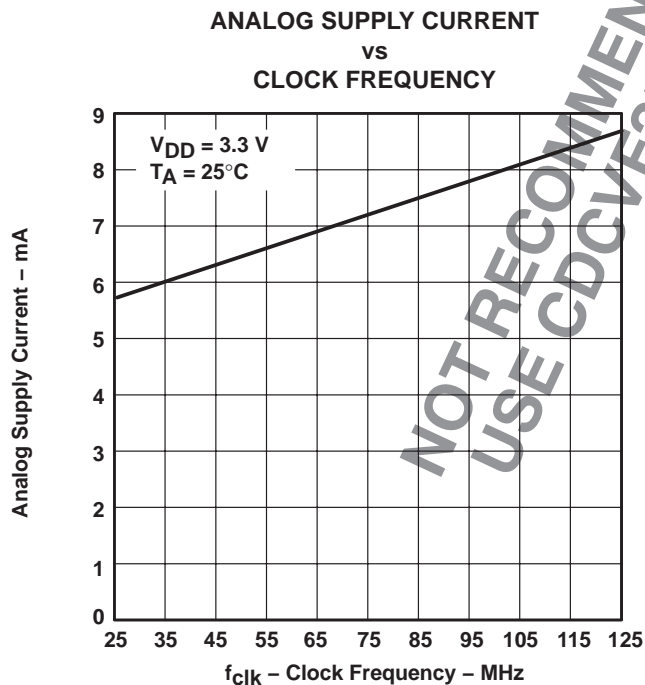

Figure 5

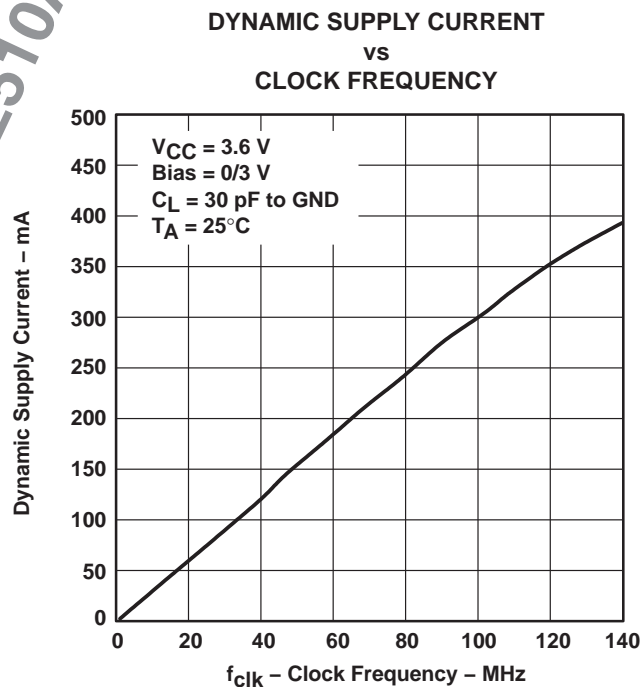

Figure 6

PACKAGING INFORMATION

Orderable Device	Status (1)	Package Type	Package Drawing	Pins	Package Qty	Eco Plan (2)	Lead finish/ Ball material (6)	MSL Peak Temp (3)	Op Temp (°C)	Device Marking (4/5)	Samples
CDC2516DGGR	ACTIVE	TSSOP	DGG	48	2000	RoHS & Green	NIPDAU	Level-2-260C-1 YEAR	0 to 70	CDC2516	Samples

(1) The marketing status values are defined as follows:

ACTIVE: Product device recommended for new designs.

LIFEBUY: TI has announced that the device will be discontinued, and a lifetime-buy period is in effect.

NRND: Not recommended for new designs. Device is in production to support existing customers, but TI does not recommend using this part in a new design.

PREVIEW: Device has been announced but is not in production. Samples may or may not be available.

OBSOLETE: TI has discontinued the production of the device.

(2) **RoHS:** TI defines "RoHS" to mean semiconductor products that are compliant with the current EU RoHS requirements for all 10 RoHS substances, including the requirement that RoHS substance do not exceed 0.1% by weight in homogeneous materials. Where designed to be soldered at high temperatures, "RoHS" products are suitable for use in specified lead-free processes. TI may reference these types of products as "Pb-Free".

RoHS Exempt: TI defines "RoHS Exempt" to mean products that contain lead but are compliant with EU RoHS pursuant to a specific EU RoHS exemption.

Green: TI defines "Green" to mean the content of Chlorine (Cl) and Bromine (Br) based flame retardants meet JS709B low halogen requirements of <=1000ppm threshold. Antimony trioxide based flame retardants must also meet the <=1000ppm threshold requirement.

(3) MSL, Peak Temp. - The Moisture Sensitivity Level rating according to the JEDEC industry standard classifications, and peak solder temperature.

(4) There may be additional marking, which relates to the logo, the lot trace code information, or the environmental category on the device.

(5) Multiple Device Markings will be inside parentheses. Only one Device Marking contained in parentheses and separated by a "~" will appear on a device. If a line is indented then it is a continuation of the previous line and the two combined represent the entire Device Marking for that device.

(6) Lead finish/Ball material - Orderable Devices may have multiple material finish options. Finish options are separated by a vertical ruled line. Lead finish/Ball material values may wrap to two lines if the finish value exceeds the maximum column width.

Important Information and Disclaimer:The information provided on this page represents TI's knowledge and belief as of the date that it is provided. TI bases its knowledge and belief on information provided by third parties, and makes no representation or warranty as to the accuracy of such information. Efforts are underway to better integrate information from third parties. TI has taken and continues to take reasonable steps to provide representative and accurate information but may not have conducted destructive testing or chemical analysis on incoming materials and chemicals. TI and TI suppliers consider certain information to be proprietary, and thus CAS numbers and other limited information may not be available for release.

In no event shall TI's liability arising out of such information exceed the total purchase price of the TI part(s) at issue in this document sold by TI to Customer on an annual basis.

TAPE AND REEL INFORMATION



QUADRANT ASSIGNMENTS FOR PIN 1 ORIENTATION IN TAPE



*All dimensions are nominal

Device	Package Type	Package Drawing	Pins	SPQ	Reel Diameter (mm)	Reel Width W1 (mm)	A0 (mm)	B0 (mm)	K0 (mm)	P1 (mm)	W (mm)	Pin1 Quadrant
CDC2516DGGR	TSSOP	DGG	48	2000	330.0	24.4	8.6	13.0	1.8	12.0	24.0	Q1

TAPE AND REEL BOX DIMENSIONS



*All dimensions are nominal

Device	Package Type	Package Drawing	Pins	SPQ	Length (mm)	Width (mm)	Height (mm)
CDC2516DGGR	TSSOP	DGG	48	2000	367.0	367.0	45.0

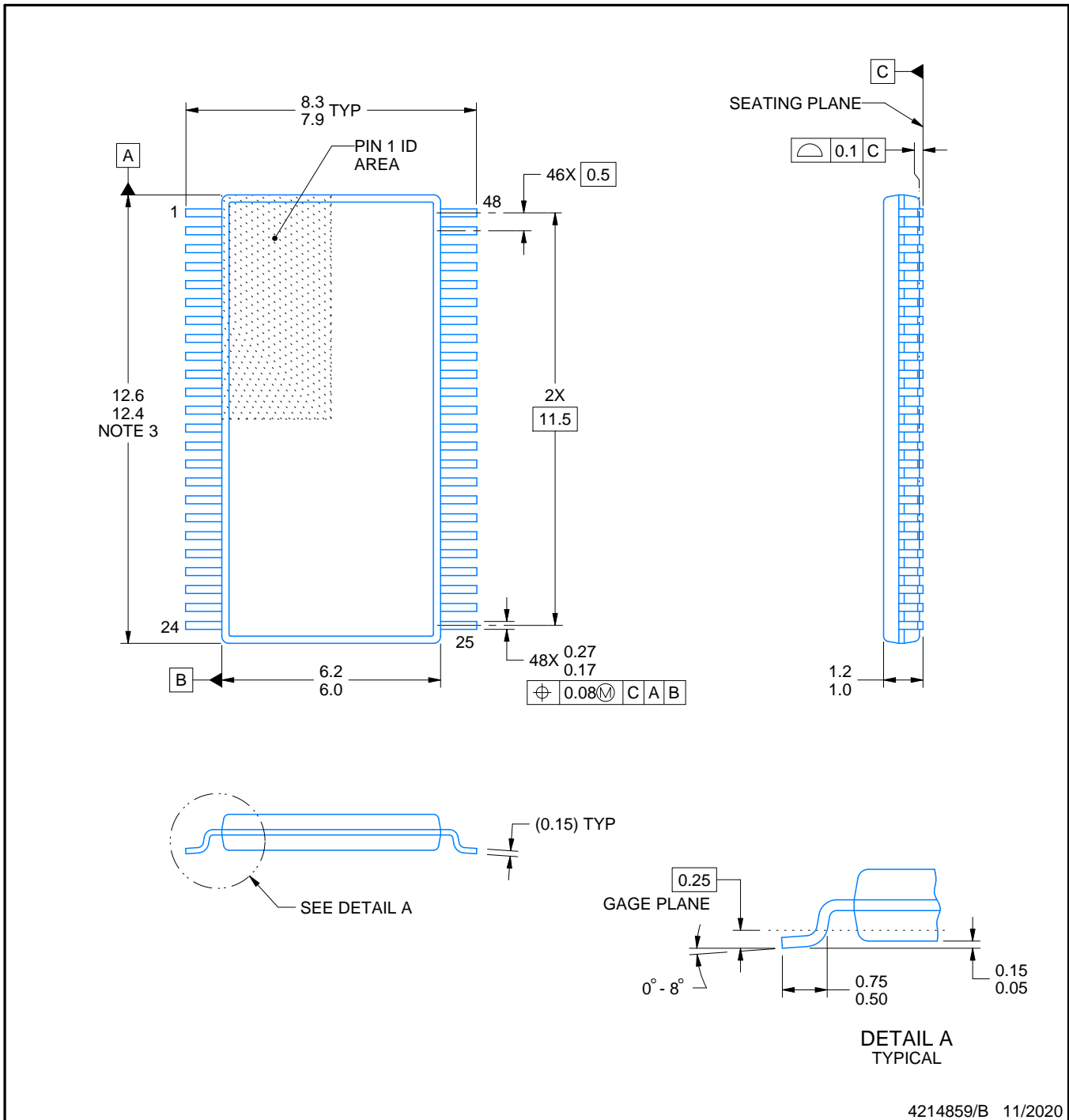

4214859/B 11/2020

NOTES:

- All linear dimensions are in millimeters. Any dimensions in parenthesis are for reference only. Dimensioning and tolerancing per ASME Y14.5M.
- This drawing is subject to change without notice.
- This dimension does not include mold flash, protrusions, or gate burrs. Mold flash, protrusions, or gate burrs shall not exceed 0.15 mm per side.
- Reference JEDEC registration MO-153.

EXAMPLE BOARD LAYOUT

DGG0048A

TSSOP - 1.2 mm max height

SMALL OUTLINE PACKAGE

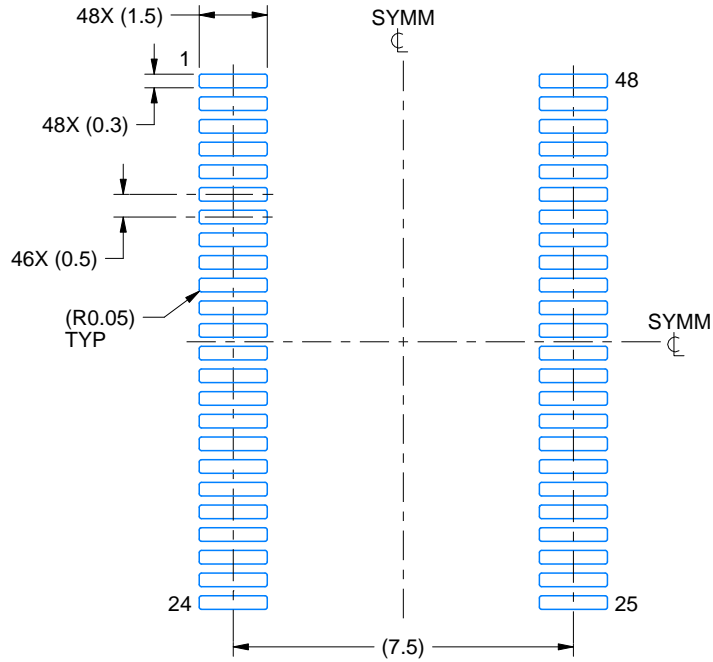

LAND PATTERN EXAMPLE
SCALE:6X



SOLDER MASK DETAILS

4214859/B 11/2020

NOTES: (continued)

5. Publication IPC-7351 may have alternate designs.
6. Solder mask tolerances between and around signal pads can vary based on board fabrication site.

EXAMPLE STENCIL DESIGN

DGG0048A

TSSOP - 1.2 mm max height

SMALL OUTLINE PACKAGE



SOLDER PASTE EXAMPLE
BASED ON 0.125 mm THICK STENCIL
SCALE:6X

4214859/B 11/2020

NOTES: (continued)

7. Laser cutting apertures with trapezoidal walls and rounded corners may offer better paste release. IPC-7525 may have alternate design recommendations.
8. Board assembly site may have different recommendations for stencil design.

DGG (R-PDSO-G**)

PLASTIC SMALL-OUTLINE PACKAGE

48 PINS SHOWN



- NOTES: A. All linear dimensions are in millimeters.
 B. This drawing is subject to change without notice.
 C. Body dimensions do not include mold protrusion not to exceed 0,15.
 D. Falls within JEDEC MO-153

IMPORTANT NOTICE AND DISCLAIMER

TI PROVIDES TECHNICAL AND RELIABILITY DATA (INCLUDING DATA SHEETS), DESIGN RESOURCES (INCLUDING REFERENCE DESIGNS), APPLICATION OR OTHER DESIGN ADVICE, WEB TOOLS, SAFETY INFORMATION, AND OTHER RESOURCES "AS IS" AND WITH ALL FAULTS, AND DISCLAIMS ALL WARRANTIES, EXPRESS AND IMPLIED, INCLUDING WITHOUT LIMITATION ANY IMPLIED WARRANTIES OF MERCHANTABILITY, FITNESS FOR A PARTICULAR PURPOSE OR NON-INFRINGEMENT OF THIRD PARTY INTELLECTUAL PROPERTY RIGHTS.

These resources are intended for skilled developers designing with TI products. You are solely responsible for (1) selecting the appropriate TI products for your application, (2) designing, validating and testing your application, and (3) ensuring your application meets applicable standards, and any other safety, security, regulatory or other requirements.

These resources are subject to change without notice. TI grants you permission to use these resources only for development of an application that uses the TI products described in the resource. Other reproduction and display of these resources is prohibited. No license is granted to any other TI intellectual property right or to any third party intellectual property right. TI disclaims responsibility for, and you will fully indemnify TI and its representatives against, any claims, damages, costs, losses, and liabilities arising out of your use of these resources.

TI's products are provided subject to [TI's Terms of Sale](#) or other applicable terms available either on ti.com or provided in conjunction with such TI products. TI's provision of these resources does not expand or otherwise alter TI's applicable warranties or warranty disclaimers for TI products.

TI objects to and rejects any additional or different terms you may have proposed.

Mailing Address: Texas Instruments, Post Office Box 655303, Dallas, Texas 75265
Copyright © 2022, Texas Instruments Incorporated