

LM3102-Q1 Automotive Synchronous 1-MHz, 2.5-A Step-Down Voltage Regulator

1 Features

- AEC-Q100-Qualified for Automotive Applications:
 - Temperature grade 1: -40°C to $+125^{\circ}\text{C}$, T_A
- Low Component Count and Small Solution Size
- Stable With Ceramic and Other Low-ESR Capacitors
- No Loop Compensation Required
- High Efficiency at a Light Load by DCM Operation
- Prebias Start-Up
- Ultra-Fast Transient Response
- Programmable Soft Start
- Programmable Switching Frequency up to 1 MHz
- Valley Current Limit
- Output Overvoltage Protection
- Precision Internal Reference for an Adjustable Output Voltage Down to 0.8 V
- Thermal Shutdown
- Key Specifications
 - Input Voltage Range 4.5 V to 42 V
 - 2.5-A Output Current
 - 0.8 V, $\pm 1.5\%$ Reference
 - Integrated Dual N-Channel Main and Synchronous MOSFETs
 - Thermally Enhanced 20-Pin HTSSOP Package
- Create a Custom Design using the LM3102-Q1 with the [WEBENCH® Power Designer](#)

2 Applications

- Automotive Body Electronics
- Automotive Lighting
- Automotive Infotainment and Telematics
- General 12-V and 24-V Automotive DC/DC Conversion

3 Description

The LM3102-Q1 synchronously rectified buck converter features all required functions to implement a highly efficient and cost-effective buck regulator. The device can supply 2.5 A to loads with an output voltage as low as 0.8 V. Dual N-channel synchronous MOSFET switches allow a low component count, thus reducing complexity and minimizing board size.

Different from most other COT regulators, the LM3102-Q1 does not rely on output capacitor ESR for stability and is designed to work exceptionally well with ceramic and other very low-ESR output capacitors. The device requires no loop compensation, results in a fast load transient response and simple circuit implementation. The operating frequency remains nearly constant with line variations due to the inverse relationship between the input voltage and the ON-time. The operating frequency can be externally programmed up to 1 MHz. Protection features include V_{CC} undervoltage lockout (UVLO), output overvoltage protection, thermal shutdown, and gate-drive UVLO. The LM3102-Q1 is available in the thermally enhanced 20-pin HTSSOP package.

Device Information⁽¹⁾

PART NUMBER	PACKAGE	BODY SIZE (NOM)
LM3102-Q1	HTSSOP (20)	6.50 mm x 4.40 mm

(1) For all available packages, see the orderable addendum at the end of the data sheet.

Typical Application Schematic

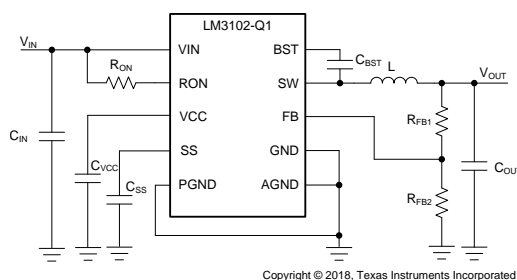

Efficiency vs Load Current ($V_{OUT} = 3.3\text{ V}$)

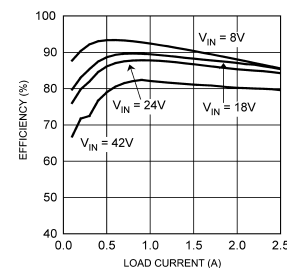

Table of Contents

1 Features 1 2 Applications 1 3 Description 1 4 Revision History 2 5 Pin Configuration and Functions 3 6 Specifications 4 6.1 Absolute Maximum Ratings 4 6.2 ESD Ratings..... 4 6.3 Recommended Operating Conditions 4 6.4 Thermal Information 4 6.5 Electrical Characteristics..... 5 6.6 Switching Characteristics 5 6.7 Typical Characteristics 7 7 Detailed Description 10 7.1 Overview 10 7.2 Functional Block Diagram 10 7.3 Feature Description..... 11	7.4 Device Functional Modes..... 14 8 Application and Implementation 15 8.1 Application Information..... 15 8.2 Typical Application 15 8.3 System Examples 19 9 Power Supply Recommendations 20 10 Layout 20 10.1 Layout Guidelines 20 10.2 Layout Example 20 11 Device and Documentation Support 21 11.1 Device Support..... 21 11.2 Receiving Notification of Documentation Updates 21 11.3 Community Resources..... 21 11.4 Trademarks 21 11.5 Electrostatic Discharge Caution..... 21 11.6 Glossary 21 12 Mechanical, Packaging, and Orderable Information 22
---	--

4 Revision History

NOTE: Page numbers for previous revisions may differ from page numbers in the current version.

DATE	REVISION	NOTES
May 2019	*	Split out LM3102-Q1 from the combined datasheet SNVS515 commercial and automotive document started September 2007. This document SNVSBE5 details the automotive LM284x-Q1. Made editorial changes; no technical changes; add WEBENCH links

5 Pin Configuration and Functions

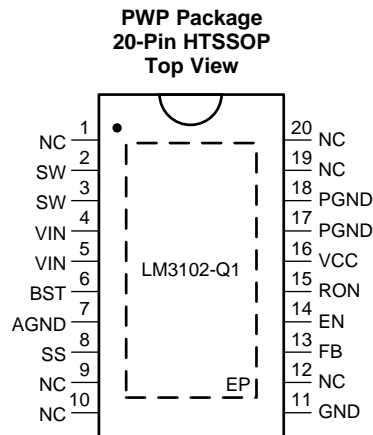

Pin Functions

PIN		TYPE	DESCRIPTION
NAME	NO.		
N/C	1	—	No Connection
	9		
	10		
	12		
	19		
SW	2	Power	Switching node
	3		
VIN	4	Power	Input supply voltage
	5		
BST	6	Power	Connection for bootstrap capacitor
AGND	7	Ground	Analog ground
SS	8	Analog	Soft start
GND	11	Ground	Ground
FB	13	Analog	Feedback
EN	14	Analog	Enable
RON	15	Analog	ON-time control
VCC	16	Power	Start-up regulator output
PGND	17	Ground	Power ground
	18		
EP	—	Ground	Exposed Pad

6 Specifications

6.1 Absolute Maximum Ratings

over operating free-air temperature range (unless otherwise noted)⁽¹⁾

	MIN	MAX	UNIT
V _{IN} , RON to AGND	-0.3	43.5	V
SW to AGND	-0.3	43.5	V
SW to AGND (Transient)		-2 (< 100 ns)	V
V _{IN} to SW	-0.3	43.5	V
BST to SW	-0.3	7	V
All Other Inputs to AGND	-0.3	7	V
Junction Temperature, T _J		150	°C
Storage Temperature, T _{stg}	-65	150	°C

- (1) Stresses beyond those listed under *Absolute Maximum Ratings* may cause permanent damage to the device. These are stress ratings only, which do not imply functional operation of the device at these or any other conditions beyond those indicated under *Recommended Operating Conditions*. Exposure to absolute-maximum-rated conditions for extended periods may affect device reliability.

6.2 ESD Ratings

	VALUE	UNIT
V _(ESD) Electrostatic discharge Human body model (HBM), per ANSI/ESDA/JEDEC JS-001 ⁽¹⁾	±2000	V

- (1) JEDEC document JEP155 states that 500-V HBM allows safe manufacturing with a standard ESD control process.

6.3 Recommended Operating Conditions

over operating free-air temperature range (unless otherwise noted)

	MIN	MAX	UNIT
V _{IN} Supply Voltage	4.5	42	V
T _J Junction Temperature	-40	125	°C

6.4 Thermal Information

THERMAL METRIC ⁽¹⁾	LM3102-Q1	UNIT
	PWP (HTSSOP)	
	20 PINS	
R _{θJA} Junction-to-ambient thermal resistance	30	°C/W
R _{θJC(top)} Junction-to-case (top) thermal resistance	6.5	°C/W

- (1) For more information about traditional and new thermal metrics, see the *Semiconductor and IC Package Thermal Metrics* application report, [SPRA953](#).

6.5 Electrical Characteristics

Specifications with standard type are for $T_J = 25^\circ\text{C}$ unless otherwise specified. Minimum and Maximum limits are specified through test, design, or statistical correlation. Typical values represent the most likely parametric norm at $T_J = 25^\circ\text{C}$, and are provided for reference purposes only. Unless otherwise stated the following conditions apply: $V_{IN} = 18\text{ V}$, $V_{OUT} = 3.3\text{ V}$.

PARAMETER		TEST CONDITIONS		MIN	TYP	MAX	UNIT
START-UP REGULATOR, V_{CC}							
V_{CC}	V_{CC} output voltage	$C_{CC} = 680\text{ nF}$, no load			6		V
			over the full Operating Junction Temperature (T_J) range	5		7.2	
$V_{IN} - V_{CC}$	$V_{IN} - V_{CC}$ dropout voltage	$I_{CC} = 2\text{ mA}$			50		mV
			over the full Operating Junction Temperature (T_J) range			200	
		$I_{CC} = 20\text{ mA}$			350		
			over the full Operating Junction Temperature (T_J) range			570	
I_{VCC}	V_{CC} current limit ⁽¹⁾	$V_{CC} = 0\text{ V}$			65		mA
			over the full Operating Junction Temperature (T_J) range	40			
$V_{CC-UVLO}$	V_{CC} undervoltage lockout threshold (UVLO)	V_{IN} increasing			3.75		V
			over the full Operating Junction Temperature (T_J) range	3.6		3.9	
$V_{CC-UVLO-HYS}$	V_{CC} UVLO hysteresis	V_{IN} decreasing – HTSSOP package			130		mV
$t_{VCC-UVLO-D}$	V_{CC} UVLO filter delay				3		μs
I_{IN}	I_{IN} operating current	No switching, $V_{FB} = 1\text{ V}$			0.7		mA
			over the full Operating Junction Temperature (T_J) range			1	
I_{IN-SD}	I_{IN} operating current, Device shutdown	$V_{EN} = 0\text{ V}$			25		μA
			over the full Operating Junction Temperature (T_J) range			40	

(1) V_{CC} provides self bias for the internal gate drive and control circuits. Device thermal limitations limit external loading.

6.6 Switching Characteristics

over operating free-air temperature range (unless otherwise noted)

PARAMETER		TEST CONDITIONS		MIN	TYP	MAX	UNIT
$R_{DS-UP-ON}$	Main MOSFET $R_{DS(on)}$				0.18		Ω
		over the full Operating Junction Temperature (T_J) range				0.375	
$R_{DS-DN-ON}$	Syn. MOSFET $R_{DS(on)}$				0.11		Ω
		over the full Operating Junction Temperature (T_J) range				0.225	
V_{G-UVLO}	Gate drive voltage UVLO	$V_{BST} - V_{SW}$ increasing			3.3		V
			over the full Operating Junction Temperature (T_J) range				

Switching Characteristics (continued)

over operating free-air temperature range (unless otherwise noted)

PARAMETER		TEST CONDITIONS		MIN	TYP	MAX	UNIT
SOFT START							
I_{SS}	SS pin source current	$V_{SS} = 0.5\text{ V}$		8		10	μA
			over the full Operating Junction Temperature (T_J) range	6			
CURRENT LIMIT							
I_{CL}	Syn. MOSFET current limit threshold			2.7			A
I_{CL}	Syn. MOSFET current limit threshold			1.5			A
ON/OFF TIMER							
t_{on}	ON timer pulse width	$V_{IN} = 10\text{ V}, R_{ON} = 100\text{ k}\Omega$		1.38			μs
		$V_{IN} = 30\text{ V}, R_{ON} = 100\text{ k}\Omega$		0.47			
t_{on-MIN}	ON timer minimum pulse width			150			ns
t_{off}	OFF timer pulse width			260			ns
ENABLE INPUT							
V_{EN}	EN Pin input threshold	V_{EN} rising	over the full Operating Junction Temperature (T_J) range	1.13	1.18	1.23	V
	Enable threshold hysteresis	V_{EN} falling		90			mV
REGULATION AND OVERVOLTAGE COMPARATOR							
V_{FB}	In-regulation feedback voltage	$V_{SS} \geq 0.8\text{ V } T_J = -40^\circ\text{C to } +125^\circ\text{C}$	over the full Operating Junction Temperature (T_J) range	0.784	0.8	0.816	V
		$V_{SS} \geq 0.8\text{ V } T_J = 0^\circ\text{C to } +125^\circ\text{C}$	over the full Operating Junction Temperature (T_J) range	0.788		0.812	
V_{FB-OV}	Feedback overvoltage threshold		over the full Operating Junction Temperature (T_J) range	0.888	0.92	0.945	V
I_{FB}				5			nA
THERMAL SHUTDOWN							
T_{SD}	Thermal shutdown temperature	T_J rising		165			$^\circ\text{C}$
T_{SD-HYS}	Thermal shutdown temperature hysteresis	T_J falling		20			$^\circ\text{C}$

6.7 Typical Characteristics

All curves are taken at $V_{IN} = 18\text{ V}$ with the configuration in the typical application circuit for $V_{OUT} = 3.3\text{ V}$ shown in this data sheet. $T_A = 25^\circ\text{C}$, unless otherwise specified.

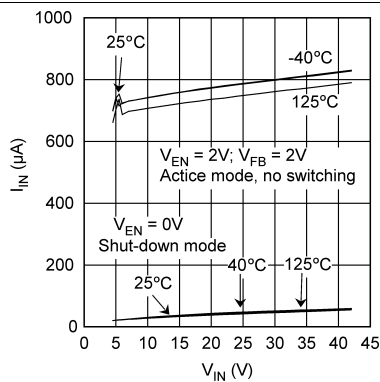

Figure 1. Quiescent Current, I_{IN} vs V_{IN}

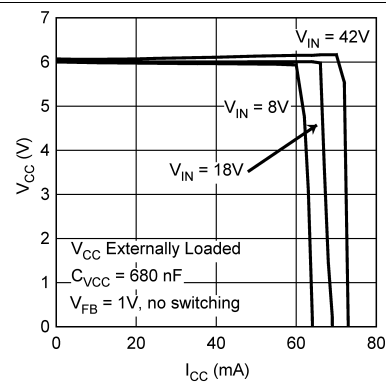

Figure 2. V_{CC} vs I_{CC}

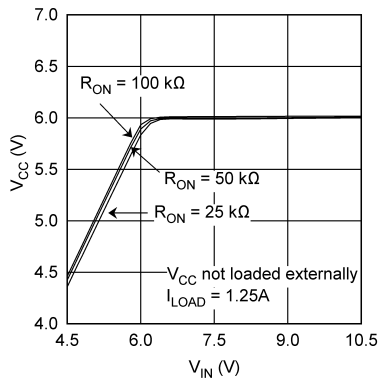

Figure 3. V_{CC} vs V_{IN}

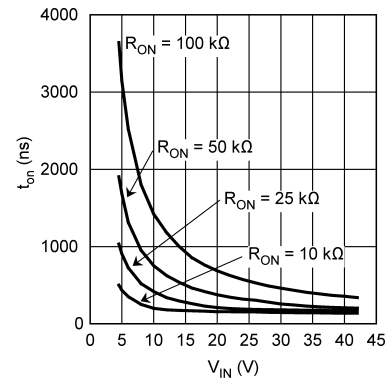

Figure 4. t_{ON} vs V_{IN}

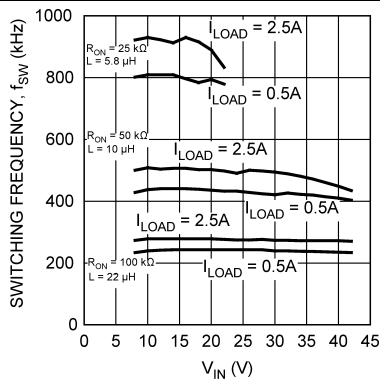

Figure 5. Switching Frequency, f_{SW} vs V_{IN}

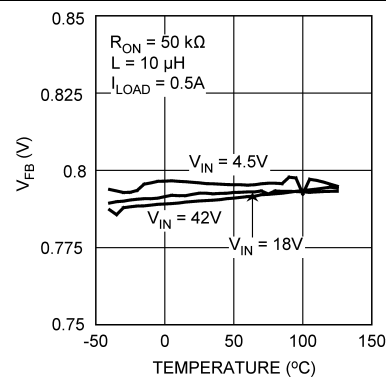

Figure 6. V_{FB} vs Temperature

Typical Characteristics (continued)

All curves are taken at $V_{IN} = 18\text{ V}$ with the configuration in the typical application circuit for $V_{OUT} = 3.3\text{ V}$ shown in this data sheet. $T_A = 25^\circ\text{C}$, unless otherwise specified.

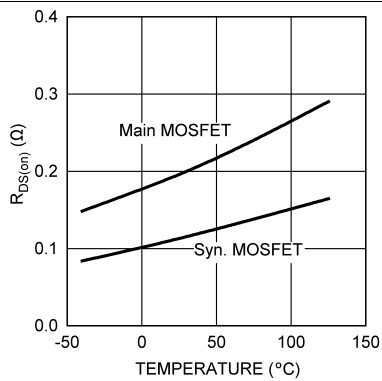

Figure 7. $R_{DS(on)}$ vs Temperature

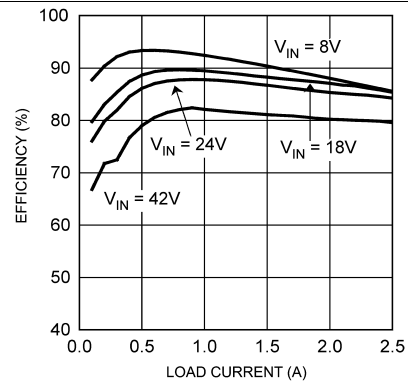

Figure 8. Efficiency vs Load Current ($V_{OUT} = 3.3\text{ V}$)

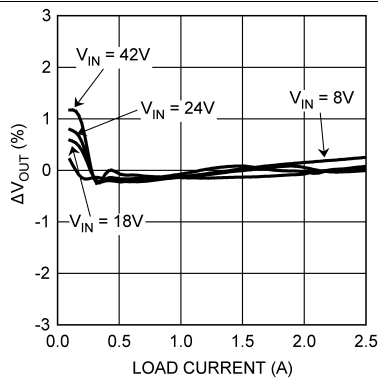

Figure 9. V_{OUT} Regulation vs Load Current ($V_{OUT} = 3.3\text{ V}$)

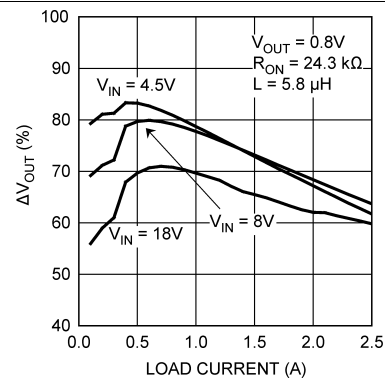

Figure 10. Efficiency vs Load Current ($V_{OUT} = 0.8\text{ V}$)

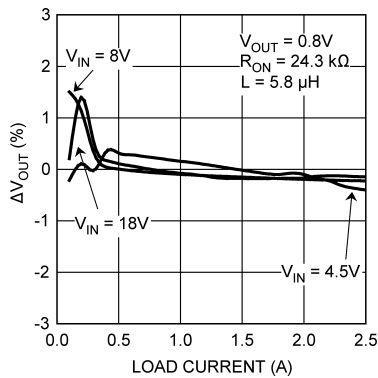

Figure 11. V_{OUT} Regulation vs Load Current ($V_{OUT} = 0.8\text{ V}$)

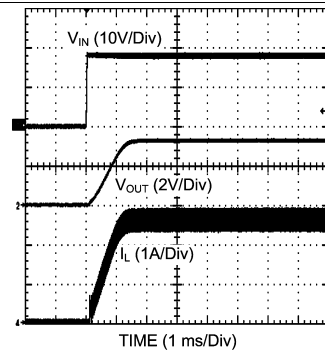

Figure 12. Power Up ($V_{OUT} = 3.3\text{ V}$, 2.5 A Loaded)

Typical Characteristics (continued)

All curves are taken at $V_{IN} = 18\text{ V}$ with the configuration in the typical application circuit for $V_{OUT} = 3.3\text{ V}$ shown in this data sheet. $T_A = 25^\circ\text{C}$, unless otherwise specified.

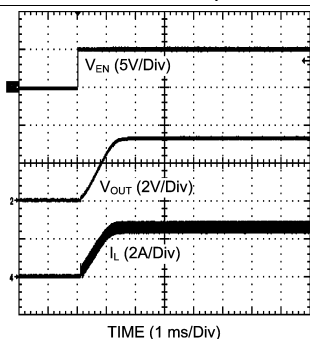

Figure 13. Enable Transient ($V_{OUT} = 3.3\text{ V}$, 2.5 A Loaded)

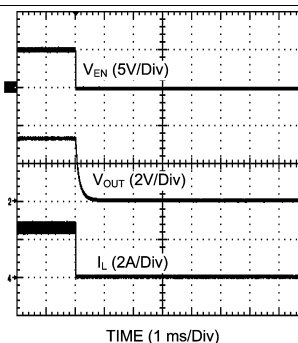

Figure 14. Shutdown Transient ($V_{OUT} = 3.3\text{ V}$, 2.5 A Loaded)

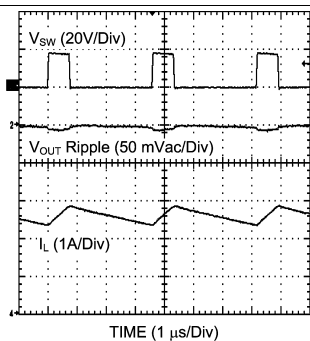

Figure 15. Continuous Mode Operation ($V_{OUT} = 3.3\text{ V}$, 2.5 A Loaded)

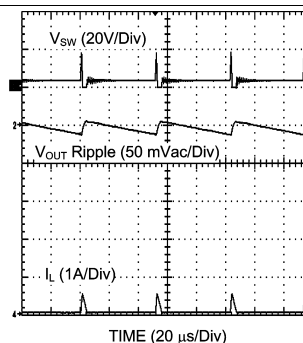

Figure 16. Discontinuous Mode Operation ($V_{OUT} = 3.3\text{ V}$, 0.025 A Loaded)

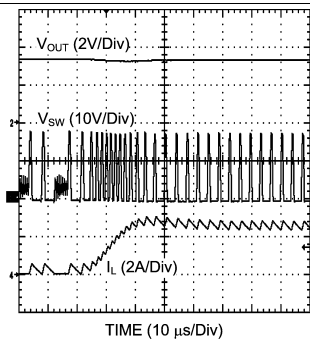

Figure 17. DCM to CCM Transition ($V_{OUT} = 3.3\text{ V}$, 0.15-A - 2.5-A Load)

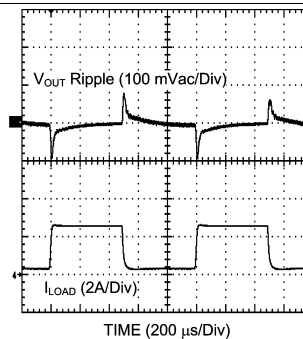

Figure 18. Load Transient ($V_{OUT} = 3.3\text{ V}$, 0.25-A - 2.5-A Load, Current Slew Rate: 2.5 A/μs)

7 Detailed Description

7.1 Overview

The LM3102-Q1 step-down switching regulator features all required functions to implement a cost-effective, efficient buck power converter capable of supplying 2.5 A to a load. It contains dual N-channel main and synchronous MOSFETs. The constant ON-Time (COT) regulation scheme requires no loop compensation, results in fast load transient response and simple circuit implementation. The regulator can function properly even with an all ceramic output capacitor network, and does not rely on the ESR of the output capacitor for stability. The operating frequency remains constant with line variations due to the inverse relationship between the input voltage and the ON-time. The valley current limit detection circuit, with the limit set internally at 2.7 A, inhibits the main MOSFET until the inductor current subsides.

The LM3102-Q1 can be applied in numerous applications and can operate efficiently for inputs as high as 42 V. Protection features include output overvoltage protection, thermal shutdown, V_{CC} UVLO, gate drive UVLO. The LM3102-Q1 is available in the thermally enhanced HTSSOP-20 package.

7.2 Functional Block Diagram

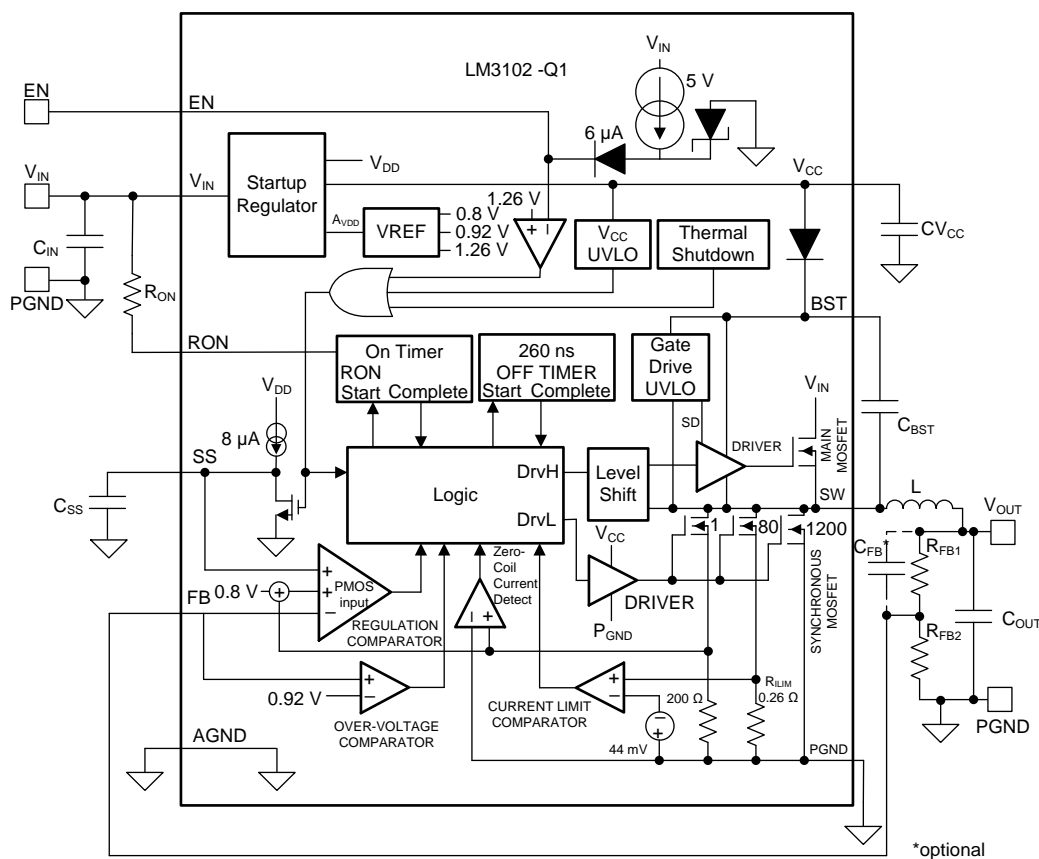

Copyright © 2018, Texas Instruments Incorporated

7.3 Feature Description

7.3.1 COT Control Circuit Overview

COT control is based on a comparator and a one-shot ON-timer, with the output voltage feedback (feeding to the FB pin) compared with an internal reference of 0.8 V. If the voltage of the FB pin is below the reference, the main MOSFET is turned on for a fixed ON-time determined by a programming resistor R_{ON} and the input voltage V_{IN} , upon which the ON-time varies inversely. Following the ON-time, the main MOSFET remains off for a minimum of 260 ns. Then, if the voltage of the FB pin is below the reference, the main MOSFET is turned on again for another ON-time period. The switching will continue to achieve regulation.

The regulator will operate in the discontinuous conduction mode (DCM) at a light load, and the continuous conduction mode (CCM) with a heavy load. In the DCM, the current through the inductor starts at zero and ramps up to a peak during the ON-time, and then ramps back to zero before the end of the OFF-time. It remains zero and the load current is supplied entirely by the output capacitor. The next ON-time period starts when the voltage at the FB pin falls below the internal reference. The operating frequency in the DCM is lower and varies larger with the load current as compared with the CCM. Conversion efficiency is maintained because conduction loss and switching loss are reduced with the reduction in the load and the switching frequency, respectively. The operating frequency in the DCM can be calculated approximately as follows:

$$f_{SW} = \frac{V_{OUT} (V_{IN} - 1) \times L \times 1.18 \times 10^{20} \times I_{OUT}}{(V_{IN} - V_{OUT}) \times R_{ON}^2} \quad (1)$$

In the continuous conduction mode (CCM), the current flows through the inductor in the entire switching cycle, and never reaches zero during the OFF-time. The operating frequency remains relatively constant with load and line variations. The CCM operating frequency can be calculated approximately as follows:

$$f_{SW} = \frac{V_{OUT}}{1.3 \times 10^{-10} \times R_{ON}} \quad (2)$$

The output voltage is set by two external resistors R_{FB1} and R_{FB2} . The regulated output voltage is

$$V_{OUT} = 0.8V \times (R_{FB1} + R_{FB2})/R_{FB2} \quad (3)$$

7.3.2 Start-Up Regulator (V_{CC})

A startup regulator is integrated within the LM3102-Q1. The input pin V_{IN} can be connected directly to a line voltage up to 42 V. The V_{CC} output regulates at 6 V, and is current limited to 65 mA. Upon power up, the regulator sources current into an external capacitor C_{VCC} , which is connected to the VCC pin. For stability, C_{VCC} must be at least 680 nF. When the voltage on the VCC pin is higher than the UVLO threshold of 3.75 V, the main MOSFET is enabled and the SS pin is released to allow the soft-start capacitor C_{SS} to charge.

The minimum input voltage is determined by the dropout voltage of the regulator and the V_{CC} UVLO falling threshold (≈ 3.7 V). If V_{IN} is less than ≈ 4.0 V, the regulator shuts off and V_{CC} goes to zero.

7.3.3 Regulation Comparator

The feedback voltage at the FB pin is compared to a 0.8-V internal reference. In normal operation (the output voltage is regulated), an ON-time period is initiated when the voltage at the FB pin falls below 0.8 V. The main MOSFET stays on for the ON-time, causing the output voltage and consequently the voltage of the FB pin to rise above 0.8 V. After the ON-time period, the main MOSFET stays off until the voltage of the FB pin falls below 0.8 V again. Bias current at the FB pin is nominally 5 nA.

7.3.4 Zero Coil Current Detect

The current of the synchronous MOSFET is monitored by a zero coil current detection circuit which inhibits the synchronous MOSFET when its current reaches zero until the next ON-time. This circuit enables the DCM operation, which improves the efficiency at a light load.

7.3.5 Overvoltage Comparator

The voltage at the FB pin is compared to a 0.92-V internal reference. If the voltage rises above 0.92 V, the ON-time is immediately terminated. This condition is known as overvoltage protection (OVP). It can occur if the input voltage or the output load changes suddenly. Once the OVP is activated, the main MOSFET remains off until the voltage at the FB pin falls below 0.92 V. The synchronous MOSFET will stay on to discharge the inductor until the inductor current reduces to zero, and then switch off.

Feature Description (continued)

7.3.6 Current Limit

Current limit detection is carried out during the OFF-time by monitoring the re-circulating current through the synchronous MOSFET. Referring to the *Functional Block Diagram*, when the main MOSFET is turned off, the inductor current flows through the load, the PGND pin and the internal synchronous MOSFET. If this current exceeds 2.7 A, the current limit comparator toggles, and as a result disabling the start of the next ON-time period. The next switching cycle starts when the re-circulating current falls back below 2.7 A (and the voltage at the FB pin is below 0.8 V). The inductor current is monitored during the ON-time of the synchronous MOSFET. As long as the inductor current exceeds 2.7 A, the main MOSFET will remain inhibited to achieve current limit. The operating frequency is lower during current limit due to a longer OFF-time.

Figure 19 illustrates an inductor current waveform. On average, the output current I_{OUT} is the same as the inductor current I_L , which is the average of the rippled inductor current. In case of current limit (the current limit portion of Figure 19), the next ON-time will not initiate until that the current drops below 2.7 A (assume the voltage at the FB pin is lower than 0.8 V). During each ON-time the current ramps up an amount equal to:

$$I_{LR} = \frac{(V_{IN} - V_{OUT}) \times t_{on}}{L} \tag{4}$$

During current limit, the LM3102-Q1 operates in a constant current mode with an average output current $I_{OUT(CL)}$ equal to $2.7\text{ A} + I_{LR} / 2$.

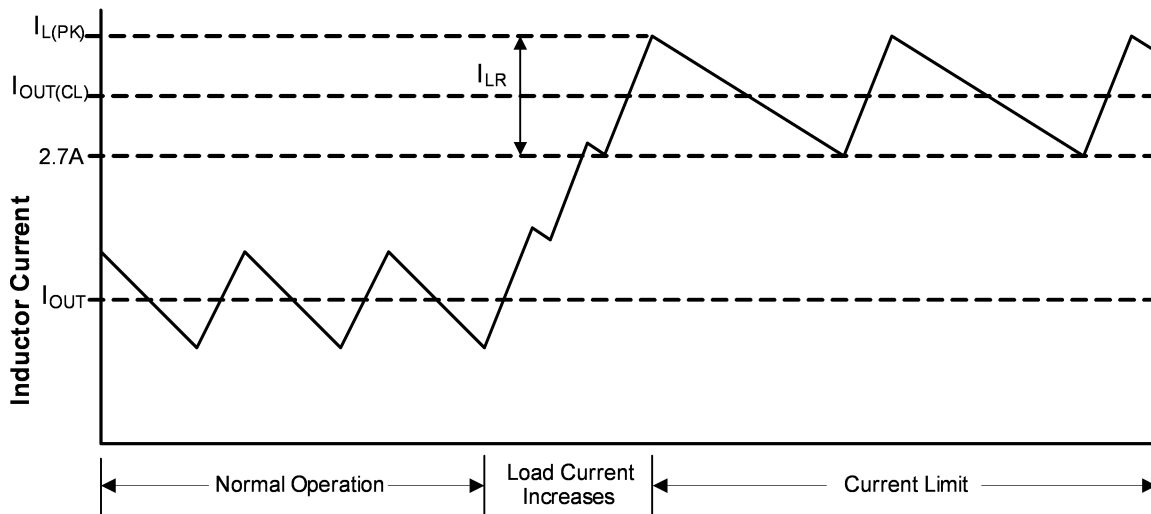

Figure 19. Inductor Current - Current Limit Operation

7.3.7 N-Channel MOSFET and Driver

The LM3102-Q1 integrates an N-channel main MOSFET and an associated floating high voltage main MOSFET gate driver. The gate drive circuit works in conjunction with an external bootstrap capacitor C_{BST} and an internal high voltage diode. C_{BST} connecting between the BST and SW pins powers the main MOSFET gate driver during the main MOSFET ON-time. During each OFF-time, the voltage of the SW pin falls to approximately -1 V , and C_{BST} charges from V_{CC} through the internal diode. The minimum OFF-time of 260 ns provides enough time for charging C_{BST} in each cycle.

7.3.8 Soft Start

The soft-start feature allows the converter to gradually reach a steady-state operating point, thereby reducing startup stresses and current surges. Upon turnon, after V_{CC} reaches the undervoltage threshold, an $8\text{-}\mu\text{A}$ internal current source charges up an external capacitor C_{SS} connecting to the SS pin. The ramping voltage at the SS pin (and the non-inverting input of the regulation comparator as well) ramps up the output voltage V_{OUT} in a controlled manner.

Feature Description (continued)

An internal switch grounds the SS pin if any of the following three cases happens: (i) V_{CC} is below the UVLO threshold; (ii) a thermal shutdown occurs; or (iii) the EN pin is grounded. Alternatively, the output voltage can be shut off by connecting the SS pin to ground using an external switch. Releasing the switch allows the SS pin to ramp up and the output voltage to return to normal. The shutdown configuration is shown in Figure 20.

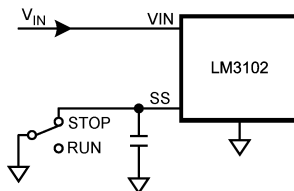

Figure 20. Alternate Shutdown Implementation

7.3.9 Thermal Protection

The junction temperature of the LM3102-Q1 should not exceed the maximum limit. Thermal protection is implemented by an internal Thermal Shutdown circuit, which activates (typically) at 165°C to make the controller enter a low power reset state by disabling the main MOSFET, disabling the ON-timer, and grounding the SS pin. Thermal protection helps prevent catastrophic failures from accidental device overheating. When the junction temperature falls back below 145°C (typical hysteresis = 20°C), the SS pin is released and normal operation resumes.

7.3.10 Thermal Derating

The LM3102-Q1 can supply 2.5 A below an ambient temperature of 100°C. Under worst-case operation, with either input voltage up to 42 V, operating frequency up to 1 MHz, or voltage of the RON pin below the absolute maximum of 7 V, the LM3102-Q1 can deliver a minimum of 1.9-A output current without thermal shutdown with a PCB ground plane copper area of 40 cm², 2 oz/Cu. Figure 21 shows a thermal derating curve for the minimum output current without thermal shutdown against ambient temperature up to 125°C. Obtaining 2.5-A output current is possible by increasing the PCB ground plane area, or reducing the input voltage or operating frequency.

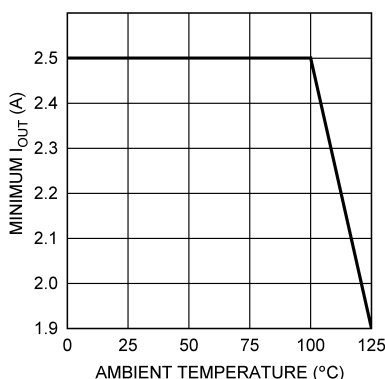

Figure 21. Thermal Derating Curve

7.4 Device Functional Modes

7.4.1 ON-Time Timer, Shutdown

The ON-time of the LM3102-Q1 main MOSFET is determined by the resistor R_{ON} and the input voltage V_{IN} . It is calculated as follows:

$$t_{on} = \frac{1.3 \times 10^{-10} \times R_{ON}}{V_{IN}} \quad (5)$$

The inverse relationship of t_{on} and V_{IN} gives a nearly constant frequency as V_{IN} is varied. R_{ON} should be selected such that the ON-time at maximum V_{IN} is greater than 150 ns. The ON-timer has a limiter to ensure a minimum of 150 ns for t_{on} . This limits the maximum operating frequency, which is governed by [Equation 6](#):

$$f_{SW(MAX)} = \frac{V_{OUT}}{V_{IN(MAX)} \times 150 \text{ ns}} \quad (6)$$

The LM3102-Q1 can be remotely shutdown by pulling the voltage of the EN pin below 1 V. In this shutdown mode, the SS pin is internally grounded, the ON-timer is disabled, and bias currents are reduced. Releasing the EN pin allows normal operation to resume because the EN pin is internally pulled up.

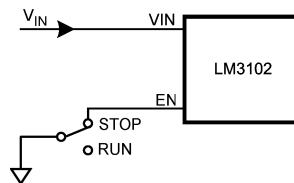

Figure 22. Shutdown Implementation

8 Application and Implementation

NOTE

Information in the following applications sections is not part of the TI component specification, and TI does not warrant its accuracy or completeness. TI's customers are responsible for determining suitability of components for their purposes. Customers should validate and test their design implementation to confirm system functionality.

8.1 Application Information

The LM3102-Q1 is a step-down DC-to-DC controller. It is typically used to convert a higher DC voltage to a lower DC voltage with a maximum output current of 2.5 A. The following design procedure can be used to select components for the LM3102-Q1. Alternately, the WEBENCH software may be used to generate complete designs.

When generating a design, the WEBENCH® software uses iterative design procedure and accesses comprehensive databases of components. For more details, go to www.ti.com.

8.2 Typical Application

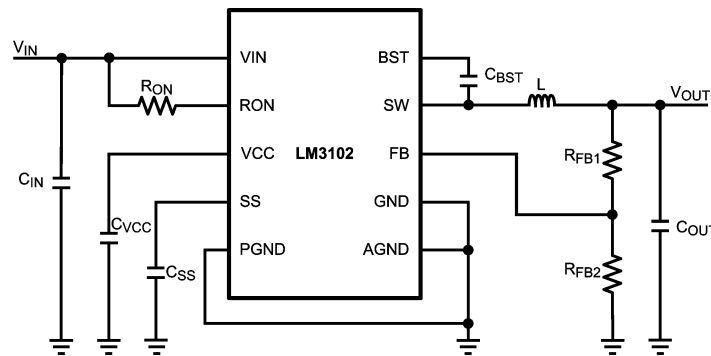

Figure 23. Typical Application Schematic

8.2.1 Design Requirements

For this example the following application parameters exist.

- V_{IN} Range = 8 V to 42 V
- V_{OUT} = 3.3 V
- I_{OUT} = 2.5 A

Refer to [Detailed Design Procedure](#) for more information on operational guidelines and limits.

8.2.2 Detailed Design Procedure

8.2.2.1 Custom Design With WEBENCH® Tools

[Click here](#) to create a custom design using the LM3102-Q1 device with the WEBENCH® Power Designer.

1. Start by entering the input voltage (V_{IN}), output voltage (V_{OUT}), and output current (I_{OUT}) requirements.
2. Optimize the design for key parameters such as efficiency, footprint, and cost using the optimizer dial.
3. Compare the generated design with other possible solutions from Texas Instruments.

The WEBENCH Power Designer provides a customized schematic along with a list of materials with real-time pricing and component availability.

In most cases, these actions are available:

- Run electrical simulations to see important waveforms and circuit performance
- Run thermal simulations to understand board thermal performance
- Export customized schematic and layout into popular CAD formats

Typical Application (continued)

- Print PDF reports for the design, and share the design with colleagues

Get more information about WEBENCH tools at www.ti.com/WEBENCH.

8.2.2.2 Design Steps for the LM3102-Q1 Application

The LM3102-Q1 is fully supported by WEBENCH which offers the following: component selection, electrical simulation, thermal simulation, as well as the build-it prototype board for a reduction in design time. The following list of steps can be used to manually design the LM3102-Q1 application.

1. Program V_O with divider resistor selection.
2. Program turnon time with soft-start capacitor selection.
3. Select C_O .
4. Select C_{IN} .
5. Set operating frequency with R_{ON} .
6. Determine thermal dissipation.
7. Lay out PCB for required thermal performance.

8.2.2.3 External Components

The following guidelines can be used to select external components.

R_{FB1} and R_{FB2} : These resistors should be chosen from standard values in the range of 1.0 k Ω to 10 k Ω , satisfying the following ratio:

$$R_{FB1}/R_{FB2} = (V_{OUT}/0.8 \text{ V}) - 1 \quad (7)$$

For $V_{OUT} = 0.8 \text{ V}$, the FB pin can be connected to the output directly with a pre-load resistor drawing more than 20 μA . It is because the converter operation needs a minimum inductor current ripple to maintain good regulation when no load is connected.

R_{ON} : Equation 2 can be used to select R_{ON} if a desired operating frequency is selected. But the minimum value of R_{ON} is determined by the minimum ON-time. It can be calculated as follows:

$$R_{ON} \geq \frac{V_{IN(MAX)} \times 150 \text{ ns}}{1.3 \times 10^{-10}} \quad (8)$$

If R_{ON} calculated from Equation 2 is smaller than the minimum value determined in Equation 8, a lower frequency should be selected to recalculate R_{ON} by Equation 2. Alternatively, $V_{IN(MAX)}$ can also be limited to keep the frequency unchanged. The relationship of $V_{IN(MAX)}$ and R_{ON} is shown in Figure 24.

On the other hand, the minimum OFF-time of 260 ns can limit the maximum duty ratio. Larger R_{ON} should be selected in any application requiring large duty ratio.

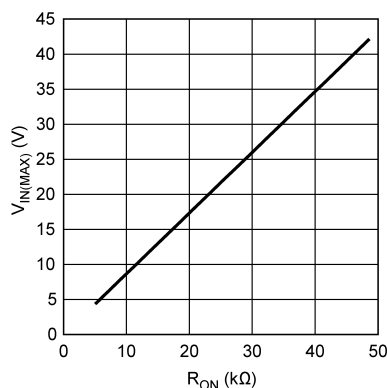

Figure 24. Maximum V_{IN} for Selected R_{ON}

L: The main parameter affected by the inductor is the amplitude of inductor current ripple (I_{LR}). Once I_{LR} is selected, L can be determined by:

Typical Application (continued)

$$L = \frac{V_{OUT} \times (V_{IN} - V_{OUT})}{I_{LR} \times f_{SW} \times V_{IN}}$$

where

- V_{IN} is the maximum input voltage
- f_{SW} is determined from [Equation 2](#)

(9)

If the output current I_{OUT} is determined, by assuming that $I_{OUT} = I_L$, the higher and lower peak of I_{LR} can be determined. Beware that the higher peak of I_{LR} should not be larger than the saturation current of the inductor and current limits of the main and synchronous MOSFETs. Also, the lower peak of I_{LR} must be positive if CCM operation is required.

[Figure 25](#) and [Figure 26](#) show curves on inductor selection for various V_{OUT} and R_{ON} . For small R_{ON} , according to (8), V_{IN} is limited. Some curves are therefore limited as shown in the figures.

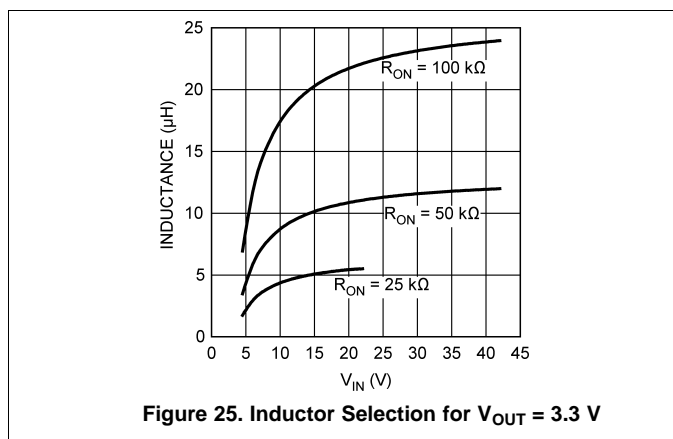

Figure 25. Inductor Selection for $V_{OUT} = 3.3$ V

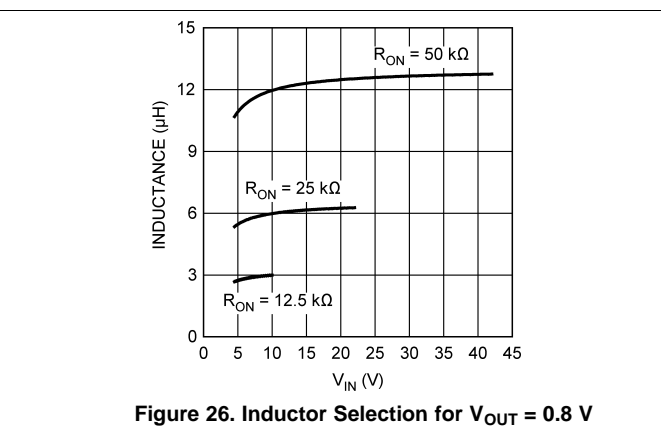

Figure 26. Inductor Selection for $V_{OUT} = 0.8$ V

C_{VCC} : The capacitor on the V_{CC} output provides not only noise filtering and stability, but also prevents false triggering of the V_{CC} UVLO at the main MOSFET on/off transitions. C_{VCC} should be no smaller than 680 nF for stability, and should be a good quality, low-ESR, ceramic capacitor.

C_{OUT} and C_{OUT3} : C_{OUT} should generally be no smaller than 10 μ F. Experimentation is usually necessary to determine the minimum value for C_{OUT} , as the nature of the load may require a larger value. A load which creates significant transients requires a larger C_{OUT} than a fixed load.

C_{OUT3} is a small value ceramic capacitor located close to the LM3102-Q1 to further suppress high frequency noise at V_{OUT} . A 100-nF capacitor is recommended.

C_{IN} and C_{IN3} : The function of C_{IN} is to supply most of the main MOSFET current during the ON-time, and limit the voltage ripple at the V_{IN} pin, assuming that the voltage source connecting to the V_{IN} pin has finite output impedance. If the voltage source's dynamic impedance is high (effectively a current source), C_{IN} supplies the average input current, but not the ripple current.

At the maximum load current, when the main MOSFET turns on, the current to the V_{IN} pin suddenly increases from zero to the lower peak of the inductor's ripple current and ramps up to the higher peak value. It then drops to zero at turnoff. The average current during the ON-time is the load current. For a worst case calculation, C_{IN} must be capable of supplying this average load current during the maximum ON-time. C_{IN} is calculated from:

$$C_{IN} = \frac{I_{OUT} \times t_{on}}{\Delta V_{IN}}$$

where

- I_{OUT} is the load current
- t_{on} is the maximum ON-time
- ΔV_{IN} is the allowable ripple voltage at V_{IN}

(10)

The purpose of C_{IN3} is to help avoid transients and ringing due to long lead inductance at the V_{IN} pin. A low ESR 0.1- μ F ceramic chip capacitor located close to the LM3102-Q1 is recommended.

Typical Application (continued)

C_{BST}: A 33-nF, high-quality ceramic capacitor with low ESR is recommended for C_{BST} because it supplies a surge current to charge the main MOSFET gate driver at turnon. Low ESR also helps ensure a complete recharge during each OFF-time.

C_{SS}: The capacitor at the SS pin determines the soft-start time, that is, the time for the reference voltage at the regulation comparator and the output voltage to reach their final value. The time is determined from the following equation:

$$t_{ss} = \frac{C_{SS} \times 0.8V}{8 \mu A} \quad (11)$$

C_{FB}: If the output voltage is higher than 1.6 V, C_{FB} is needed in the Discontinuous Conduction Mode to reduce the output ripple. The recommended value for C_{FB} is 10 nF.

8.2.3 Application Curve

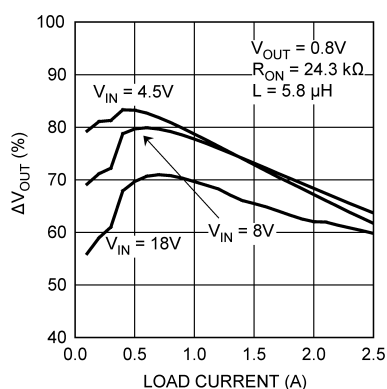

Figure 27. Efficiency vs Load Current (V_{OUT} = 0.8 V)

8.3 System Examples

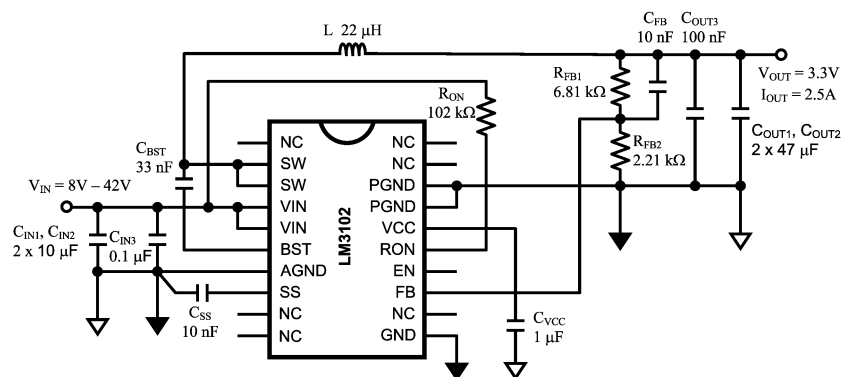

Figure 28. Typical Application Schematic for $V_{OUT} = 3.3\ V$

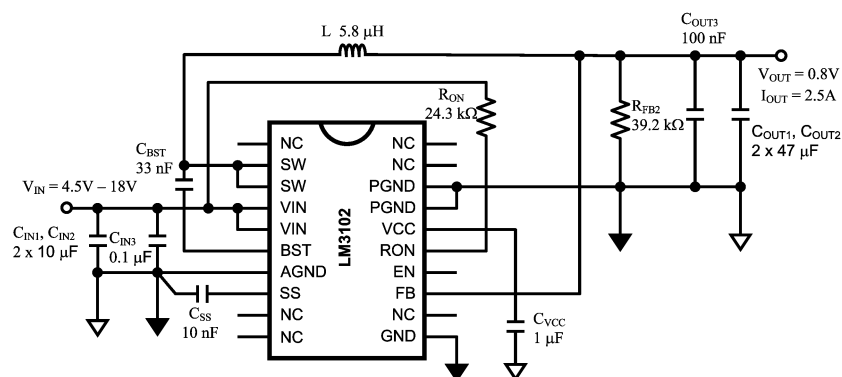

Figure 29. Typical Application Schematic for $V_{OUT} = 0.8\ V$

9 Power Supply Recommendations

The LM3102-Q1 device is designed to operate from an input voltage supply range between 4.5 V and 42 V. This input supply should be well regulated and able to withstand maximum input current and maintain a stable voltage. The resistance of the input supply rail must be low enough that an input current transient does not cause a high enough drop at the LM3102-Q1 supply voltage that can cause a false UVLO fault triggering and system reset. If the input supply is more than a few inches from the LM3102-Q1, additional bulk capacitance may be required in addition to the ceramic bypass capacitors. The amount of bulk capacitance is not critical, but a 47- μ F or 100- μ F electrolytic capacitor is a typical choice.

10 Layout

10.1 Layout Guidelines

The LM3102-Q1 regulation, overvoltage, and current limit comparators are very fast so they will respond to short duration noise pulses. Layout is therefore critical for optimum performance. It must be as neat and compact as possible, and all external components must be as close to their associated pins of the LM3102-Q1 as possible.

Refer to [Layout Example](#), the loop formed by C_{IN} , the main and synchronous MOSFET internal to the LM3102-Q1, and the PGND pin should be as small as possible. The connection from the PGND pin to C_{IN} should be as short and direct as possible. Vias should be added to connect the ground of C_{IN} to a ground plane, located as close to the capacitor as possible. The bootstrap capacitor C_{BST} should be connected as close to the SW and BST pins as possible, and the connecting traces should be thick. The feedback resistors and capacitor R_{FB1} , R_{FB2} , and C_{FB} should be close to the FB pin.

A long trace running from V_{OUT} to R_{FB1} is generally acceptable because this is a low-impedance node. Ground R_{FB2} directly to the AGND pin (pin 7). The output capacitor C_{OUT} should be connected close to the load and tied directly to the ground plane. The inductor L should be connected close to the SW pin with as short a trace as possible to reduce the potential for EMI (electromagnetic interference) generation.

If it is expected that the internal dissipation of the LM3102-Q1 will produce excessive junction temperature during normal operation, making good use of the PCB ground plane can help considerably to dissipate heat. The exposed pad on the bottom of the LM3102-Q1 IC package can be soldered to the ground plane, which should extend out from beneath the LM3102-Q1 to help dissipate heat.

The exposed pad is internally connected to the LM3102-Q1 IC substrate. Additionally the use of thick traces, where possible, can help conduct heat away from the LM3102-Q1. Using numerous vias to connect the die attached pad to the ground plane is a good practice. Judicious positioning of the PCB within the end product, along with the use of any available air flow (forced or natural convection) can help reduce the junction temperature.

10.2 Layout Example

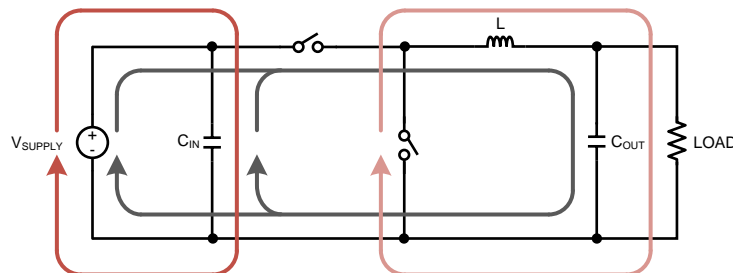

Figure 30. Minimize Area of Current Loops in Buck Regulators

11 Device and Documentation Support

11.1 Device Support

11.1.1 Development Support

11.1.1.1 Custom Design With WEBENCH® Tools

Click [here](#) to create a custom design using the LM3102-Q1 device with the WEBENCH® Power Designer.

1. Start by entering the input voltage (V_{IN}), output voltage (V_{OUT}), and output current (I_{OUT}) requirements.
2. Optimize the design for key parameters such as efficiency, footprint, and cost using the optimizer dial.
3. Compare the generated design with other possible solutions from Texas Instruments.

The WEBENCH Power Designer provides a customized schematic along with a list of materials with real-time pricing and component availability.

In most cases, these actions are available:

- Run electrical simulations to see important waveforms and circuit performance
- Run thermal simulations to understand board thermal performance
- Export customized schematic and layout into popular CAD formats
- Print PDF reports for the design, and share the design with colleagues

Get more information about WEBENCH tools at www.ti.com/WEBENCH.

11.2 Receiving Notification of Documentation Updates

To receive notification of documentation updates, navigate to the device product folder on ti.com. In the upper right corner, click on *Alert me* to register and receive a weekly digest of any product information that has changed. For change details, review the revision history included in any revised document.

11.3 Community Resources

The following links connect to TI community resources. Linked contents are provided "AS IS" by the respective contributors. They do not constitute TI specifications and do not necessarily reflect TI's views; see TI's [Terms of Use](#).

TI E2E™ Online Community *TI's Engineer-to-Engineer (E2E) Community*. Created to foster collaboration among engineers. At e2e.ti.com, you can ask questions, share knowledge, explore ideas and help solve problems with fellow engineers.

Design Support *TI's Design Support* Quickly find helpful E2E forums along with design support tools and contact information for technical support.

11.4 Trademarks

E2E is a trademark of Texas Instruments.

WEBENCH is a registered trademark of Texas Instruments.

All other trademarks are the property of their respective owners.

11.5 Electrostatic Discharge Caution



This integrated circuit can be damaged by ESD. Texas Instruments recommends that all integrated circuits be handled with appropriate precautions. Failure to observe proper handling and installation procedures can cause damage.

ESD damage can range from subtle performance degradation to complete device failure. Precision integrated circuits may be more susceptible to damage because very small parametric changes could cause the device not to meet its published specifications.

11.6 Glossary



[SLYZ022](#) — *TI Glossary*.

This glossary lists and explains terms, acronyms, and definitions.

12 Mechanical, Packaging, and Orderable Information

The following pages include mechanical, packaging, and orderable information. This information is the most current data available for the designated devices. This data is subject to change without notice and revision of this document. For browser-based versions of this data sheet, refer to the left-hand navigation.

PACKAGING INFORMATION

Orderable Device	Status (1)	Package Type	Package Drawing	Pins	Package Qty	Eco Plan (2)	Lead finish/ Ball material (6)	MSL Peak Temp (3)	Op Temp (°C)	Device Marking (4/5)	Samples
LM3102QMH/NOPB	ACTIVE	HTSSOP	PWP	20	73	RoHS & Green	SN	Level-1-260C-UNLIM	-40 to 125	LM3102 QMH	
LM3102QMHX/NOPB	ACTIVE	HTSSOP	PWP	20	2500	RoHS & Green	SN	Level-1-260C-UNLIM	-40 to 125	LM3102 QMH	

(1) The marketing status values are defined as follows:

ACTIVE: Product device recommended for new designs.

LIFEBUY: TI has announced that the device will be discontinued, and a lifetime-buy period is in effect.

NRND: Not recommended for new designs. Device is in production to support existing customers, but TI does not recommend using this part in a new design.

PREVIEW: Device has been announced but is not in production. Samples may or may not be available.

OBSOLETE: TI has discontinued the production of the device.

(2) **RoHS:** TI defines "RoHS" to mean semiconductor products that are compliant with the current EU RoHS requirements for all 10 RoHS substances, including the requirement that RoHS substance do not exceed 0.1% by weight in homogeneous materials. Where designed to be soldered at high temperatures, "RoHS" products are suitable for use in specified lead-free processes. TI may reference these types of products as "Pb-Free".

RoHS Exempt: TI defines "RoHS Exempt" to mean products that contain lead but are compliant with EU RoHS pursuant to a specific EU RoHS exemption.

Green: TI defines "Green" to mean the content of Chlorine (Cl) and Bromine (Br) based flame retardants meet JS709B low halogen requirements of <=1000ppm threshold. Antimony trioxide based flame retardants must also meet the <=1000ppm threshold requirement.

(3) MSL, Peak Temp. - The Moisture Sensitivity Level rating according to the JEDEC industry standard classifications, and peak solder temperature.

(4) There may be additional marking, which relates to the logo, the lot trace code information, or the environmental category on the device.

(5) Multiple Device Markings will be inside parentheses. Only one Device Marking contained in parentheses and separated by a "~" will appear on a device. If a line is indented then it is a continuation of the previous line and the two combined represent the entire Device Marking for that device.

(6) Lead finish/Ball material - Orderable Devices may have multiple material finish options. Finish options are separated by a vertical ruled line. Lead finish/Ball material values may wrap to two lines if the finish value exceeds the maximum column width.

Important Information and Disclaimer:The information provided on this page represents TI's knowledge and belief as of the date that it is provided. TI bases its knowledge and belief on information provided by third parties, and makes no representation or warranty as to the accuracy of such information. Efforts are underway to better integrate information from third parties. TI has taken and continues to take reasonable steps to provide representative and accurate information but may not have conducted destructive testing or chemical analysis on incoming materials and chemicals. TI and TI suppliers consider certain information to be proprietary, and thus CAS numbers and other limited information may not be available for release.

In no event shall TI's liability arising out of such information exceed the total purchase price of the TI part(s) at issue in this document sold by TI to Customer on an annual basis.

OTHER QUALIFIED VERSIONS OF LM3102-Q1 :

- Catalog: [LM3102](#)

NOTE: Qualified Version Definitions:

- Catalog - TI's standard catalog product

TAPE AND REEL INFORMATION

QUADRANT ASSIGNMENTS FOR PIN 1 ORIENTATION IN TAPE

*All dimensions are nominal

Device	Package Type	Package Drawing	Pins	SPQ	Reel Diameter (mm)	Reel Width W1 (mm)	A0 (mm)	B0 (mm)	K0 (mm)	P1 (mm)	W (mm)	Pin1 Quadrant
LM3102QMHX/NOPB	HTSSOP	PWP	20	2500	330.0	16.4	6.95	7.0	1.4	8.0	16.0	Q1

TAPE AND REEL BOX DIMENSIONS

*All dimensions are nominal

Device	Package Type	Package Drawing	Pins	SPQ	Length (mm)	Width (mm)	Height (mm)
LM3102QMHX/NOPB	HTSSOP	PWP	20	2500	367.0	367.0	35.0

TUBE

*All dimensions are nominal

Device	Package Name	Package Type	Pins	SPQ	L (mm)	W (mm)	T (μm)	B (mm)
LM3102QMH/NOPB	PWP	HTSSOP	20	73	495	8	2514.6	4.06

IMPORTANT NOTICE AND DISCLAIMER

TI PROVIDES TECHNICAL AND RELIABILITY DATA (INCLUDING DATA SHEETS), DESIGN RESOURCES (INCLUDING REFERENCE DESIGNS), APPLICATION OR OTHER DESIGN ADVICE, WEB TOOLS, SAFETY INFORMATION, AND OTHER RESOURCES "AS IS" AND WITH ALL FAULTS, AND DISCLAIMS ALL WARRANTIES, EXPRESS AND IMPLIED, INCLUDING WITHOUT LIMITATION ANY IMPLIED WARRANTIES OF MERCHANTABILITY, FITNESS FOR A PARTICULAR PURPOSE OR NON-INFRINGEMENT OF THIRD PARTY INTELLECTUAL PROPERTY RIGHTS.

These resources are intended for skilled developers designing with TI products. You are solely responsible for (1) selecting the appropriate TI products for your application, (2) designing, validating and testing your application, and (3) ensuring your application meets applicable standards, and any other safety, security, regulatory or other requirements.

These resources are subject to change without notice. TI grants you permission to use these resources only for development of an application that uses the TI products described in the resource. Other reproduction and display of these resources is prohibited. No license is granted to any other TI intellectual property right or to any third party intellectual property right. TI disclaims responsibility for, and you will fully indemnify TI and its representatives against, any claims, damages, costs, losses, and liabilities arising out of your use of these resources.

TI's products are provided subject to [TI's Terms of Sale](#) or other applicable terms available either on [ti.com](https://www.ti.com) or provided in conjunction with such TI products. TI's provision of these resources does not expand or otherwise alter TI's applicable warranties or warranty disclaimers for TI products.

TI objects to and rejects any additional or different terms you may have proposed.

Mailing Address: Texas Instruments, Post Office Box 655303, Dallas, Texas 75265
Copyright © 2024, Texas Instruments Incorporated