

TAS6582-Q1 - 45-V, 10-A Digital Input 2-Channel Automotive Class-D Audio Amplifier with Current Sense and Real-time Load Diagnostics

1 Features

- AEC-Q100 qualified for automotive applications
 - Temperature grade 1: -40°C to $+125^{\circ}\text{C}$, T_A
- General operation
 - 4.5-V to 45-V supply voltage, 50-V load dump
 - Support for 1.8-V and 3.3-V I/O's
 - I²C control with 8 address options
 - $<1.3\text{ W}$ idle power loss at 14.4 V, $<8\text{-}\mu\text{A}$ max VBAT+PVDD shutdown loss
- Integrated DSP processing
 - Class-H supply voltage control
 - Thermal monitoring and foldback
 - Clip detection, PVDD monitoring and foldback
- Output current sensing by channel via I²S/TDM
 - No need for external circuitry
- Real-time load diagnostics
 - Monitor output conditions while playing audio
 - Open load, Shorted load, Short-to-power, Short-to-ground detection
- DC and AC Standby load diagnostics
- Audio inputs
 - 2 channel I²S or 4-16 channel TDM input
 - Input sample rates: 44.1, 48, 96, 192 kHz
 - Secondary low latency path, $>70\%$ reduced signal delay at 48 kHz
- Audio outputs
 - 2-channel bridge-tied load (BTL), configurable 1-channel parallel BTL (PBTL)
 - 384-kHz to 2.1-MHz configurable output switching frequency
 - Up to 10-A channel output current
 - 400-VA peak BTL output power
 - 118 W (45 V, 8 Ω , 1% THD, BTL)
 - 215 W (45 V, 4 Ω , 1% THD, BTL)
- Audio Performance
 - THD+N 0.03% (8 Ω , 1 W, 1 kHz)
 - 111 dB SNR
 - 37 μV (14.4 V), 80 μV (45 V) output noise
- Protection
 - Output short protection
 - DC offset, undervoltage and overvoltage
 - Configurable overtemperature warning and individual channel shutdown
 - I²C temperature and supply voltage readout
- Easily meet CISPR25-L5 EMC specification

– Advanced spread-spectrum

2 Applications

- [Automotive external amplifier](#)
- [Automotive head unit](#)

3 Description

The TAS6582-Q1 is a two-channel, digital-input, high-voltage, Class-D audio amplifier that supports up to 45-V supply voltage. In combination with up to 10-A output current, this device delivers maximum output power and high fidelity audio in high and low impedance loads. The device provides two channels at 118 W (45 V, 8 Ω , 1% THD, BTL) and 215 W (45 V, 4 Ω , 1% THD, BTL).

The TAS6582-Q1 integrates DC and AC load diagnostics to determine the status of the connected loads before enabling the output stage. During audio playback, the status can be monitored through output current sense which is available for each channel and reports the measurement to a host processor through TDM with minimal delay. The device monitors the output load condition while playing audio using real-time load diagnostics which operate independent from host and audio input.

To optimize system efficiency, the integrated DSP of the TAS6582-Q1 enables Class-H envelope tracking control, eliminating the need for development of complex tracking software and making local boost voltage control possible without the need for an external microcontroller.

The TAS6582-Q1 device features an additional low-latency signal path for each channel, providing up to 70% faster signal processing at 48 kHz which enables time-sensitive Active Noise Cancellation (ANC), Road Noise Cancellation (RNC) applications.

The device is offered in a 64-pin QFP package with the exposed thermal pad up.

Device Information

PART NUMBER	PACKAGE ⁽¹⁾	BODY SIZE (NOM)
TAS6582-Q1	HTQFP (64)	14.00 mm x 14.00 mm

(1) For all available packages, see the orderable addendum at the end of the data sheet.



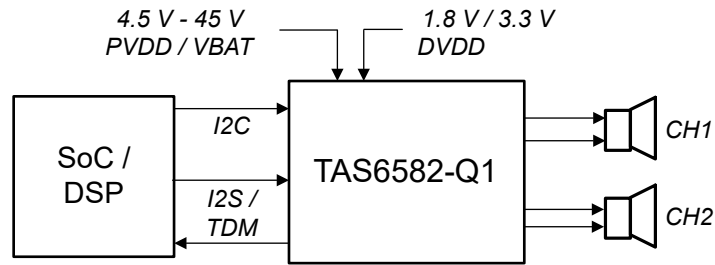

ADVANCE INFORMATION

Table of Contents

1 Features	1	5.3 Support Resources.....	4
2 Applications	1	5.4 Trademarks.....	4
3 Description	1	5.5 Electrostatic Discharge Caution.....	4
4 Revision History	3	5.6 Glossary.....	4
5 Device and Documentation Support	4	6 Mechanical, Packaging, and Orderable Information	4
5.1 Documentation Support.....	4	6.1 Tape and Reel Information.....	8
5.2 Receiving Notification of Documentation Updates.....	4		

4 Revision History

NOTE: Page numbers for previous revisions may differ from page numbers in the current version.

DATE	REVISION	NOTES
June 2023	*	Initial Release

5 Device and Documentation Support

TI offers an extensive line of development tools. Tools and software to evaluate the performance of the device, generate code, and develop solutions are listed below.

5.1 Documentation Support

5.1.1 Related Documentation

5.2 Receiving Notification of Documentation Updates

To receive notification of documentation updates, navigate to the device product folder on ti.com. Click on *Subscribe to updates* to register and receive a weekly digest of any product information that has changed. For change details, review the revision history included in any revised document.

5.3 Support Resources

[TI E2E™ support forums](#) are an engineer's go-to source for fast, verified answers and design help — straight from the experts. Search existing answers or ask your own question to get the quick design help you need.

Linked content is provided "AS IS" by the respective contributors. They do not constitute TI specifications and do not necessarily reflect TI's views; see TI's [Terms of Use](#).

5.4 Trademarks

TI E2E™ is a trademark of Texas Instruments.
All trademarks are the property of their respective owners.

5.5 Electrostatic Discharge Caution



This integrated circuit can be damaged by ESD. Texas Instruments recommends that all integrated circuits be handled with appropriate precautions. Failure to observe proper handling and installation procedures can cause damage.

ESD damage can range from subtle performance degradation to complete device failure. Precision integrated circuits may be more susceptible to damage because very small parametric changes could cause the device not to meet its published specifications.

5.6 Glossary

[TI Glossary](#) This glossary lists and explains terms, acronyms, and definitions.

6 Mechanical, Packaging, and Orderable Information

The packaging, and orderable information can be found in the TAS6582-Q1 short-version PDF (SLOSEB3), available for download from [TAS6582-Q1](#). This information is the most current data available for the designated devices. This data is subject to change without notice and revision of this document. For browser-based versions of this data sheet, refer to the left-hand navigation in the TAS6582-Q1 short-version data sheet, available for download from [TAS6582-Q1](#).

PACKAGE OUTLINE
HTQFP - 1.2 mm max height

PHD0064B

PLASTIC QUAD FLATPACK

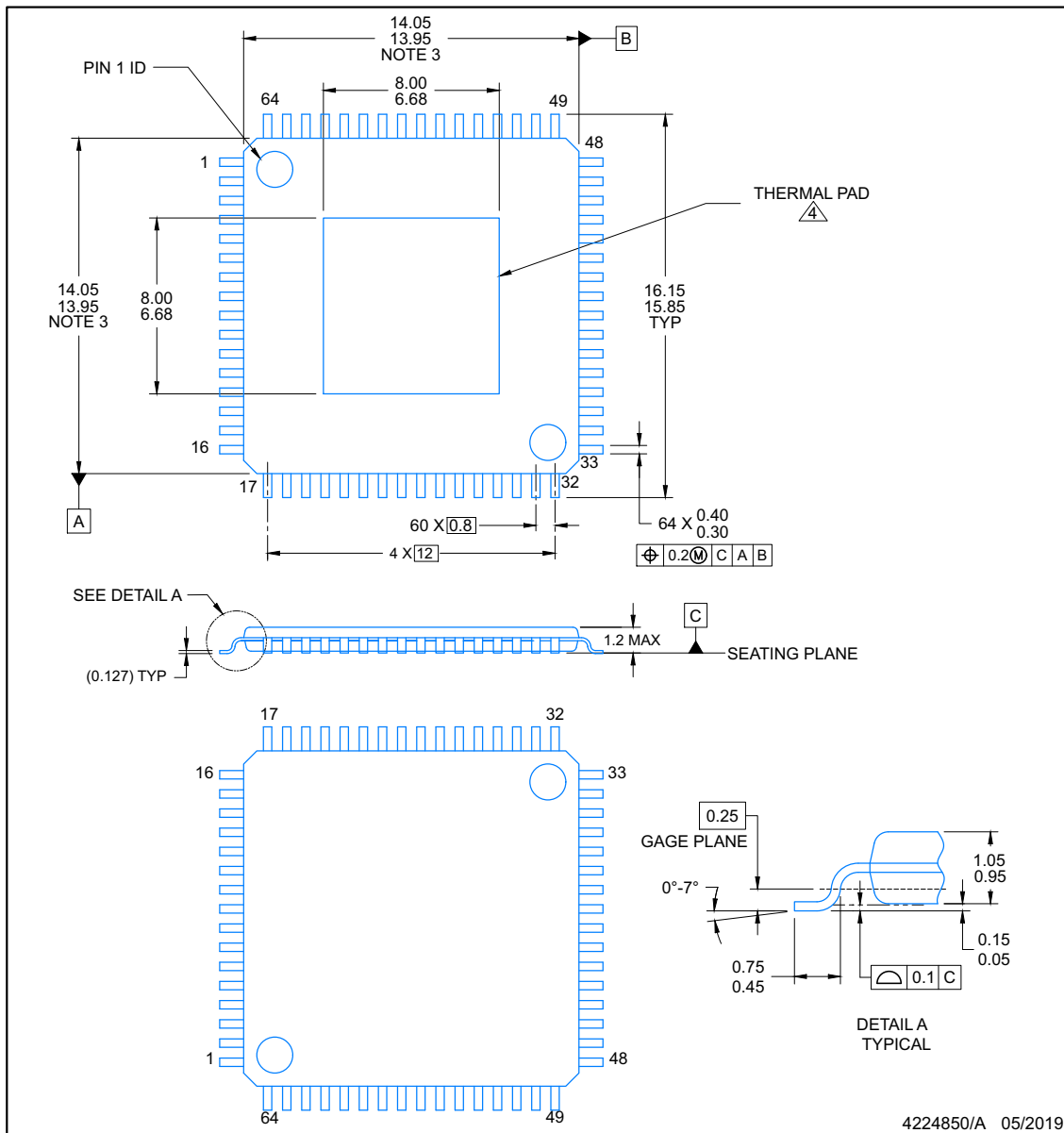

NOTES:

1. All linear dimensions are in millimeters. Any dimensions in parenthesis are for reference only. Dimensioning and tolerancing per ASME Y14.5M.
2. This drawing is subject to change without notice.
3. This dimension does not include mold flash, protrusions, or gate burrs. Mold flash, protrusions, or gate burrs shall not exceed 0.15 per side.
4. See technical brief. PowerPad Thermally Enhanced Package, Texas Instruments Literature No. SLMA002 (www.ti.com/lit/slma002) and SLMA004 (www.ti.com/lit/slma004) for information regarding recommended board layout.

EXAMPLE BOARD LAYOUT
HTQFP - 1.2 mm max height

PHD0064B

PLASTIC QUAD FLATPACK

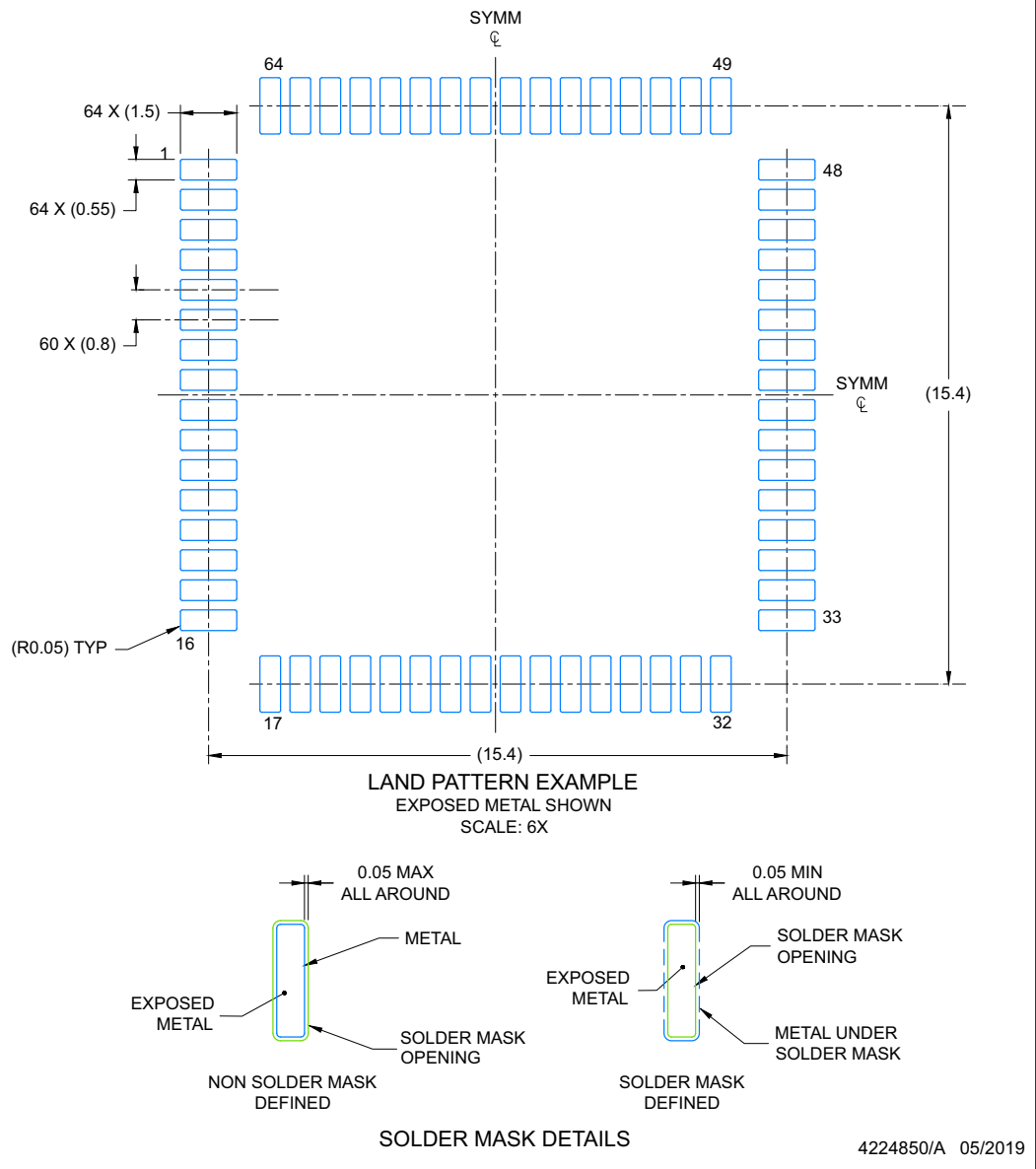

NOTES: (continued)

5. Publication IPC-7351 may have alternate designs.
6. Solder mask tolerances between and around signal pads can vary based on board fabrication site.
7. Vias are optional depending on application, refer to device data sheet. It is recommended that vias under paste be filled, plugged or tented.

EXAMPLE STENCIL DESIGN

PHD0064B

HTQFP - 1.2 mm max height

PLASTIC QUAD FLATPACK

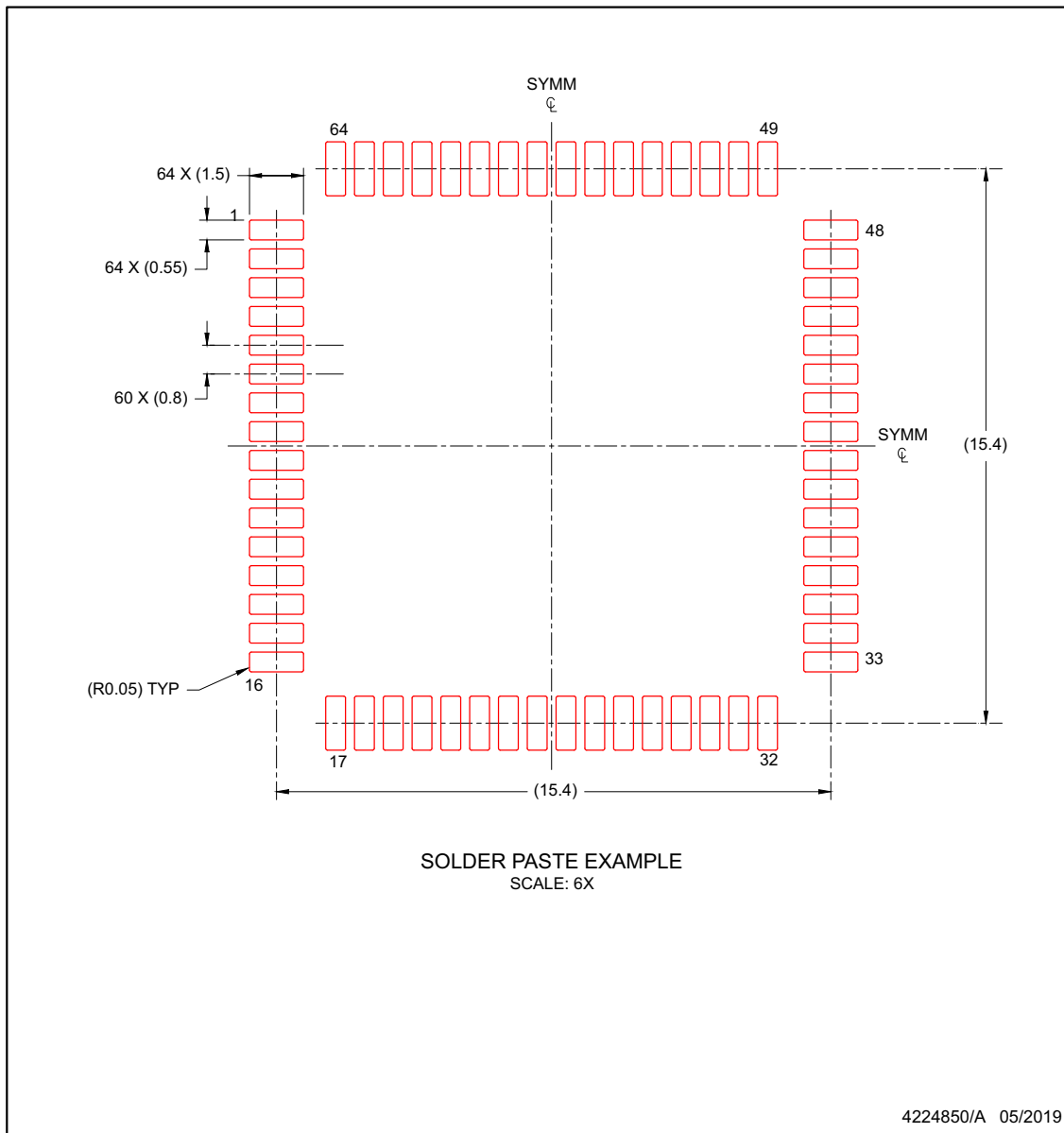

NOTES: (continued)

7. Laser cutting apertures with trapezoidal walls and rounded corners may offer better paste release. IPC-7525 may have alternate design recommendations.
8. Board assembly site may have different recommendations for stencil design.

ADVANCE INFORMATION

6.1 Tape and Reel Information

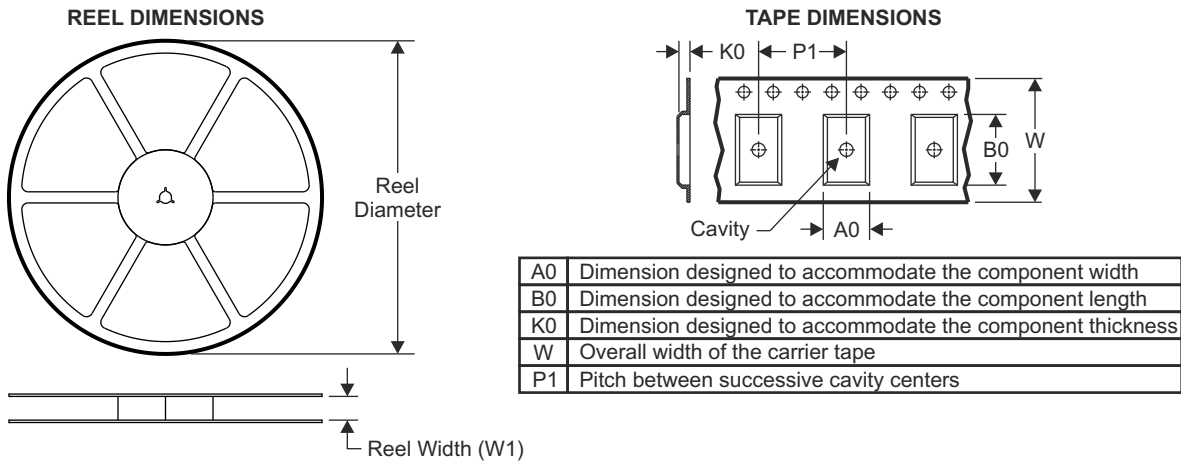

QUADRANT ASSIGNMENTS FOR PIN 1 ORIENTATION IN TAPE

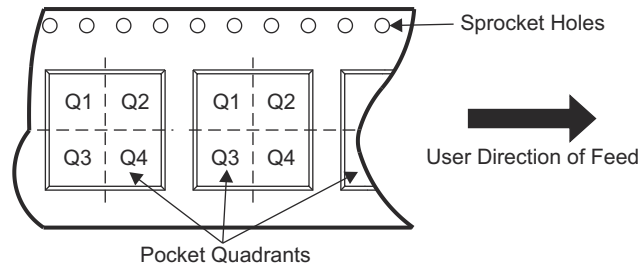

Device	Package Type	Package Drawing	Pins	SPQ	Reel Diameter (mm)	Reel Width W1 (mm)	A0 (mm)	B0 (mm)	K0 (mm)	P1 (mm)	W (mm)	Pin1 Quadrant
TAS6582QPHDRQ1	HTQFP	PHD	64	1000	330.0	24.4	17.0	17.0	1.5	20.0	24.0	Q2

ADVANCE INFORMATION

TAPE AND REEL BOX DIMENSIONS



Device	Package Type	Package Drawing	Pins	SPQ	Length (mm)	Width (mm)	Height (mm)
TAS6582QPHDRQ1	HTQFP	PHD	64	1000	350.0	350.0	43.0

ADVANCE INFORMATION

PACKAGING INFORMATION

Orderable Device	Status (1)	Package Type	Package Drawing	Pins	Package Qty	Eco Plan (2)	Lead finish/ Ball material (6)	MSL Peak Temp (3)	Op Temp (°C)	Device Marking (4/5)	Samples
PTAS6582QPHDRQ1	ACTIVE	HTQFP	PHD	64	1000	TBD	Call TI	Call TI	-40 to 125		Samples

(1) The marketing status values are defined as follows:

ACTIVE: Product device recommended for new designs.

LIFEBUY: TI has announced that the device will be discontinued, and a lifetime-buy period is in effect.

NRND: Not recommended for new designs. Device is in production to support existing customers, but TI does not recommend using this part in a new design.

PREVIEW: Device has been announced but is not in production. Samples may or may not be available.

OBSELETE: TI has discontinued the production of the device.

(2) **RoHS:** TI defines "RoHS" to mean semiconductor products that are compliant with the current EU RoHS requirements for all 10 RoHS substances, including the requirement that RoHS substance do not exceed 0.1% by weight in homogeneous materials. Where designed to be soldered at high temperatures, "RoHS" products are suitable for use in specified lead-free processes. TI may reference these types of products as "Pb-Free".

RoHS Exempt: TI defines "RoHS Exempt" to mean products that contain lead but are compliant with EU RoHS pursuant to a specific EU RoHS exemption.

Green: TI defines "Green" to mean the content of Chlorine (Cl) and Bromine (Br) based flame retardants meet JS709B low halogen requirements of <=1000ppm threshold. Antimony trioxide based flame retardants must also meet the <=1000ppm threshold requirement.

(3) MSL, Peak Temp. - The Moisture Sensitivity Level rating according to the JEDEC industry standard classifications, and peak solder temperature.

(4) There may be additional marking, which relates to the logo, the lot trace code information, or the environmental category on the device.

(5) Multiple Device Markings will be inside parentheses. Only one Device Marking contained in parentheses and separated by a "~" will appear on a device. If a line is indented then it is a continuation of the previous line and the two combined represent the entire Device Marking for that device.

(6) Lead finish/Ball material - Orderable Devices may have multiple material finish options. Finish options are separated by a vertical ruled line. Lead finish/Ball material values may wrap to two lines if the finish value exceeds the maximum column width.

Important Information and Disclaimer:The information provided on this page represents TI's knowledge and belief as of the date that it is provided. TI bases its knowledge and belief on information provided by third parties, and makes no representation or warranty as to the accuracy of such information. Efforts are underway to better integrate information from third parties. TI has taken and continues to take reasonable steps to provide representative and accurate information but may not have conducted destructive testing or chemical analysis on incoming materials and chemicals. TI and TI suppliers consider certain information to be proprietary, and thus CAS numbers and other limited information may not be available for release.

In no event shall TI's liability arising out of such information exceed the total purchase price of the TI part(s) at issue in this document sold by TI to Customer on an annual basis.

GENERIC PACKAGE VIEW

PHD 64

HTQFP - 1.2 mm max height

14 x 14, 0.8 mm pitch

PLASTIC QUAD FLATPACK

This image is a representation of the package family, actual package may vary.
Refer to the product data sheet for package details.

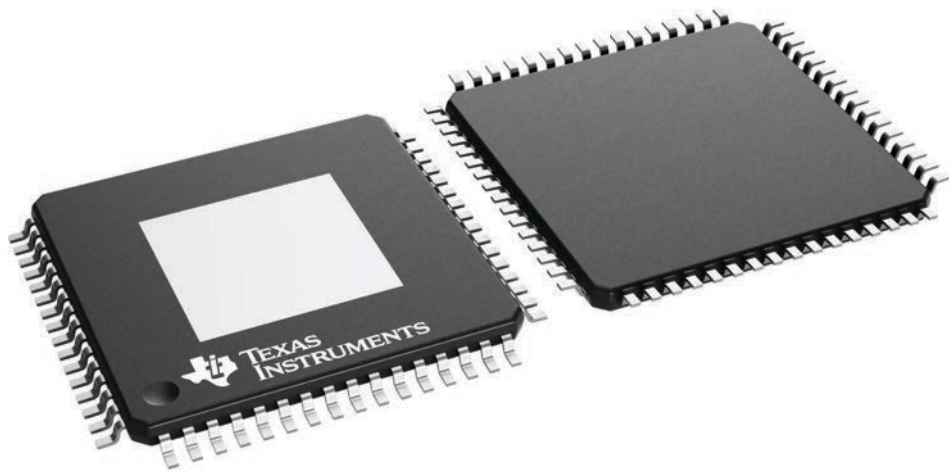

4224851/B

IMPORTANT NOTICE AND DISCLAIMER

TI PROVIDES TECHNICAL AND RELIABILITY DATA (INCLUDING DATA SHEETS), DESIGN RESOURCES (INCLUDING REFERENCE DESIGNS), APPLICATION OR OTHER DESIGN ADVICE, WEB TOOLS, SAFETY INFORMATION, AND OTHER RESOURCES "AS IS" AND WITH ALL FAULTS, AND DISCLAIMS ALL WARRANTIES, EXPRESS AND IMPLIED, INCLUDING WITHOUT LIMITATION ANY IMPLIED WARRANTIES OF MERCHANTABILITY, FITNESS FOR A PARTICULAR PURPOSE OR NON-INFRINGEMENT OF THIRD PARTY INTELLECTUAL PROPERTY RIGHTS.

These resources are intended for skilled developers designing with TI products. You are solely responsible for (1) selecting the appropriate TI products for your application, (2) designing, validating and testing your application, and (3) ensuring your application meets applicable standards, and any other safety, security, regulatory or other requirements.

These resources are subject to change without notice. TI grants you permission to use these resources only for development of an application that uses the TI products described in the resource. Other reproduction and display of these resources is prohibited. No license is granted to any other TI intellectual property right or to any third party intellectual property right. TI disclaims responsibility for, and you will fully indemnify TI and its representatives against, any claims, damages, costs, losses, and liabilities arising out of your use of these resources.

TI's products are provided subject to [TI's Terms of Sale](#) or other applicable terms available either on [ti.com](https://www.ti.com) or provided in conjunction with such TI products. TI's provision of these resources does not expand or otherwise alter TI's applicable warranties or warranty disclaimers for TI products.

TI objects to and rejects any additional or different terms you may have proposed.

Mailing Address: Texas Instruments, Post Office Box 655303, Dallas, Texas 75265
Copyright © 2024, Texas Instruments Incorporated