

TLV733P-Q1

Capacitor-Free, 300-mA, Low Dropout (LDO) Linear Regulator

1 Features

- AEC-Q100 qualified for automotive applications:
 - Temperature grade 1: -40°C to 125°C , T_A
- Device junction temperature range: -40°C to 150°C
- Input voltage range: 1.4 V to 5.5 V
- Stable operation with or without capacitors
- Foldback overcurrent protection
- Package:
 - 2.0-mm \times 2.0-mm WSON-6
 - 2.9-mm \times 1.6-mm SOT-23
- Very low dropout: 125 mV at 300 mA (3.3 V_{OUT})
- Accuracy: 1% typical, 1.4% maximum
- Low I_Q: 34 μA
- Available in fixed-output voltages: 1.0 V to 3.3 V
- High PSRR: 50 dB at 1 kHz
- Active output discharge

2 Applications

- Camera modules
- Automotive infotainment
- Navigation systems

3 Description

The TLV733P-Q1 family of low dropout (LDO) linear regulators are ultra-small, low quiescent current LDOs that can source 300 mA with good line and load transient performance. These devices provide a typical accuracy of 1%.

The TLV733P-Q1 family is designed with a modern capacitor-free architecture to ensure stability without an input or output capacitor. The removal of the output capacitor allows for a very small solution size, and can eliminate inrush current at startup. Furthermore, the TLV733P-Q1 family is also stable with ceramic output capacitors if an output capacitor is necessary. The TLV733P-Q1 family also provides foldback current control during device power-up and enabling if an output capacitor is used. This functionality is especially important in battery-operated devices.

The TLV733P-Q1 family provides an active pulldown circuit to quickly discharge output loads when disabled.

The TLV733P-Q1 family is available in the 6-pin DRV (WSON) and 5-pin DBV (SOT-23) packages.

Device Information (1)

PART NUMBER	PACKAGE	BODY SIZE (NOM)
TLV733P-Q1	WSON (6)	2.00 mm \times 2.00 mm
	SOT-23 (5)	2.90 mm \times 1.60 mm

- (1) For all available packages, see the package option addendum at the end of the data sheet.

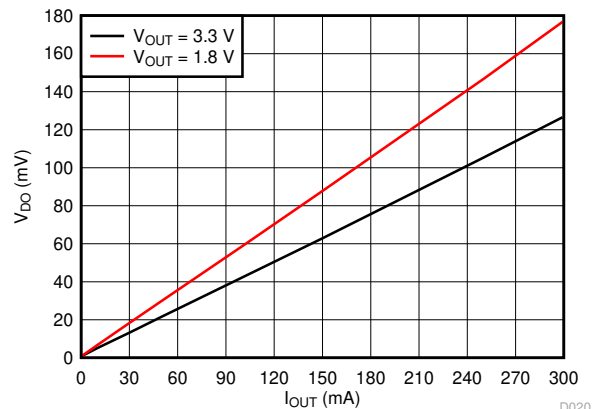
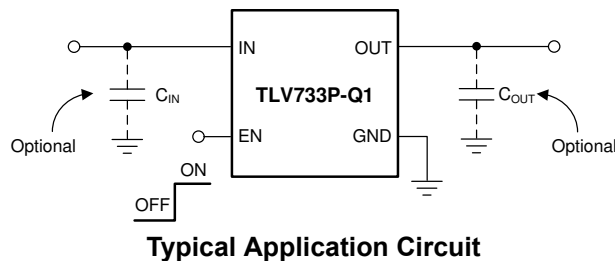

Table of Contents

1 Features	1	7.3 Feature Description.....	13
2 Applications	1	7.4 Device Functional Modes.....	14
3 Description	1	8 Application and Implementation	15
4 Revision History	2	8.1 Application Information.....	15
5 Pin Configuration and Functions	4	8.2 Typical Applications.....	16
6 Specifications	5	9 Layout	18
6.1 Absolute Maximum Ratings.....	5	9.1 Layout Guidelines.....	18
6.2 ESD Ratings.....	5	9.2 Layout Examples.....	18
6.3 Recommended Operating Conditions.....	5	10 Device and Documentation Support	19
6.4 Thermal Information.....	5	10.1 Device Support.....	19
6.5 Electrical Characteristics.....	6	10.2 Receiving Notification of Documentation Updates..	19
6.6 Timing Requirements.....	7	10.3 Support Resources.....	19
6.7 Typical Characteristics.....	8	10.4 Trademarks.....	19
7 Detailed Description	12	10.5 Electrostatic Discharge Caution.....	19
7.1 Overview.....	12	10.6 Glossary.....	19
7.2 Functional Block Diagram.....	12		

4 Revision History

NOTE: Page numbers for previous revisions may differ from page numbers in the current version.

Changes from Revision E (July 2019) to Revision F (October 2020)	Page
• Updated the numbering format for tables and figures throughout the document.....	1
• Changed automotive-specific <i>Features</i> bullets.....	1
• Changed storage temperature max parameter from 160°C to 150°C.....	5
• Added classification levels to <i>ESD Ratings</i> table.....	5
Changes from Revision D (December 2018) to Revision E (July 2019)	Page
• Changed description of EN pin in <i>Pin Functions</i> table.....	4
• Deleted typical specifications from $V_{EN(HI)}$ and $V_{EN(LO)}$ parameters in <i>Electrical Characteristics</i> table.....	6
• Added maximum specification to I_{LIM} parameter in <i>Electrical Characteristics</i> table.....	6
• Added <i>and Output Enable</i> to title and changed first paragraph of <i>Shutdown and Output Enable</i> section.....	13
Changes from Revision C (October 2018) to Revision D (December 2018)	Page
• Changed status of DBV package to Production Data	1
Changes from Revision B (August 2018) to Revision C (October 2018)	Page
• Added DBV package to document as Preview.....	1
Changes from Revision A (August 2016) to Revision B (August 2018)	Page
• Added <i>Device Junction Temperature Range</i> Features bullet	1
• Changed T_J maximum specification from 135°C to 150°C	5
• Changed <i>Electrical Characteristics</i> conditions statement from $T_J, T_A = -40^\circ\text{C to } +125^\circ\text{C}$ to $T_J = -40^\circ\text{C to } +150^\circ\text{C}, T_A = -40^\circ\text{C to } +125^\circ\text{C}$	6
• Added last 6 rows to V_{DO} parameter	6
• Added second row to IGND parameter, added temperature range to first row test conditions	6
• Changed <i>Typical Characteristics</i> condition statement from $T_J = -40^\circ\text{C to } +125^\circ\text{C}$ to $T_J = -40^\circ\text{C to } +150^\circ\text{C}$	8
• Changed operating junction temperature from $-40^\circ\text{C to } +135^\circ\text{C}$ to $-40^\circ\text{C to } +150^\circ\text{C}$ in <i>Overview</i> section.....	12
• Changed junction temperature limit from 135°C to 150°C in <i>Thermal Shutdown</i> section.....	13

Changes from Revision * (August 2016) to Revision A (August 2016)

Page

- Released to production **1**
-

5 Pin Configuration and Functions

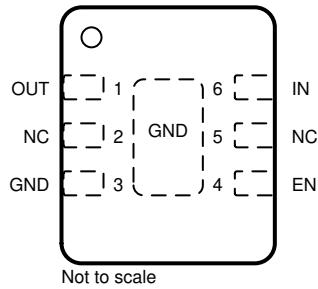

NC – No internal connection.

Figure 5-1. DRV Package, 6-Pin WSON, Top View

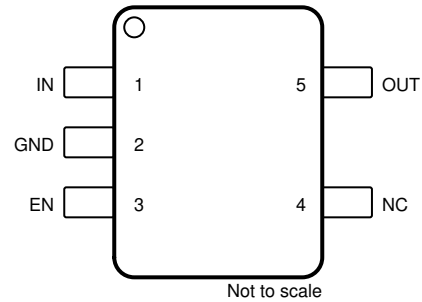

Figure 5-2. DBV Package, 5-Pin SOT-23, Top View

Table 5-1. Pin Functions

NAME	NO.		I/O	DESCRIPTION
	DRV	DBV		
EN	4	3	I	Enable pin. Drive EN greater than $V_{EN(HI)}$ to turn on the regulator. Drive EN less than $V_{EN(LO)}$ to put the LDO into shutdown mode.
GND	3	2	—	Ground pin
IN	6	1	I	Input pin. A small capacitor is recommended from this pin to ground. See the Input and Output Capacitor Selection section for more details.
NC	2, 5	4	—	No internal connection
OUT	1	5	O	Regulated output voltage pin. For best transient response, use a small 1- μ F ceramic capacitor from this pin to ground. See the Input and Output Capacitor Selection section for more details.
Thermal pad	—	—	—	The thermal pad is electrically connected to the GND node. Connect to the GND plane for improved thermal performance.

6 Specifications

6.1 Absolute Maximum Ratings

over operating junction temperature range (unless otherwise noted); all voltages are with respect to GND⁽¹⁾

		MIN	MAX	UNIT
Voltage	V _{IN}	-0.3	6.0	V
	V _{EN}	-0.3	V _{IN} + 0.3	
	V _{OUT}	-0.3	3.6	
Current	I _{OUT}	Internally limited		A
Output short-circuit duration		Indefinite		
Temperature	Operating junction, T _J	-40	150	°C
	Storage, T _{stg}	-65	150	

- (1) Stresses beyond those listed under *Absolute Maximum Ratings* may cause permanent damage to the device. These are stress ratings only, which do not imply functional operation of the device at these or any other conditions beyond those indicated under *Recommended Operating Conditions*. Exposure to absolute-maximum-rated conditions for extended periods may affect device reliability.

6.2 ESD Ratings

			VALUE	UNIT	
V _(ESD)	Electrostatic discharge	Human-body model (HBM), per AEC Q100-002 ⁽¹⁾ , classification level 2	±2000	V	
		Charged-device model (CDM), per AEC Q100-011, classification level C4B	All pins		±500
			Corner pins (1, 3, 4, and 6)		±750

- (1) AEC Q100-002 indicates that HBM stressing shall be in accordance with the ANSI/ESDA/JEDEC JS-001 specification.

6.3 Recommended Operating Conditions

over operating junction temperature range (unless otherwise noted)

		MIN	NOM	MAX	UNIT
V _{IN}	Input range	1.4		5.5	V
V _{OUT}	Output range	1.0		3.3	V
I _{OUT}	Output current	0		300	mA
V _{EN}	Enable range	0		V _{IN}	V
T _J	Junction temperature	-40		150	°C
T _A	Ambient temperature	-40		125	°C

6.4 Thermal Information

THERMAL METRIC ⁽¹⁾		TLV733P-Q1		UNIT
		DRV (WSON)	DBV (SOT-23)	
		6 PINS	5 PINS	
R _{θJA}	Junction-to-ambient thermal resistance	92.5	198.3	°C/W
R _{θJC(top)}	Junction-to-case (top) thermal resistance	123.9	118.4	°C/W
R _{θJB}	Junction-to-board thermal resistance	61.9	65.8	°C/W
ψ _{JT}	Junction-to-top characterization parameter	9.7	42.4	°C/W
ψ _{JB}	Junction-to-board characterization parameter	62.3	65.5	°C/W
R _{θJC(bot)}	Junction-to-case (bottom) thermal resistance	30.9	n/a	°C/W

- (1) For more information about traditional and new thermal metrics, see the [Semiconductor and IC Package Thermal Metrics](#) application report.

6.5 Electrical Characteristics

at operating temperature range ($T_J = -40^\circ\text{C}$ to $+150^\circ\text{C}$, $T_A = -40^\circ\text{C}$ to $+125^\circ\text{C}$), $V_{IN} = V_{OUT(nom)} + 0.5\text{ V}$ or 2.0 V (whichever is greater), $I_{OUT} = 1\text{ mA}$, $V_{EN} = V_{IN}$, and $C_{IN} = C_{OUT} = 1\text{ }\mu\text{F}$ (unless otherwise noted); all typical values are at $T_J = 25^\circ\text{C}$

PARAMETER		TEST CONDITIONS	MIN	TYP	MAX	UNIT
V_{IN}	Input voltage		1.4		5.5	V
	DC output accuracy	$T_J = 25^\circ\text{C}$	-1%		1%	
		$-40^\circ\text{C} \leq T_J \leq 150^\circ\text{C}$	-1.4%		1.4%	
UVLO	Undervoltage lockout	V_{IN} rising		1.3	1.4	V
		V_{IN} falling		1.25		
$\Delta V_{O(\Delta VI)}$	Line regulation	$\Delta VI = V_{OUT(nom)} + 0.5\text{ V}$ or 2.0 V (whichever is greater) to 5.5 V		1		mV
$\Delta V_{O(\Delta IO)}$	Load regulation	$\Delta IO = 1\text{ mA}$ to 300 mA		25		mV
V_{DO}	Dropout voltage ⁽¹⁾	$V_{OUT} = 0.98 \times V_{OUT(nom)}$, $I_{OUT} = 300\text{ mA}$	$V_{OUT} = 1.1\text{ V}$, $-40^\circ\text{C} \leq T_J \leq +125^\circ\text{C}$		510	mV
			$1.2\text{ V} \leq V_{OUT} < 1.5\text{ V}$, $-40^\circ\text{C} \leq T_J \leq 125^\circ\text{C}$		450	
			$1.5\text{ V} \leq V_{OUT} < 1.8\text{ V}$, $-40^\circ\text{C} \leq T_J \leq 125^\circ\text{C}$		400	
			$1.8\text{ V} \leq V_{OUT} < 2.5\text{ V}$, $-40^\circ\text{C} \leq T_J \leq 125^\circ\text{C}$		300	
			$2.5\text{ V} \leq V_{OUT} < 3.3\text{ V}$, $-40^\circ\text{C} \leq T_J \leq 125^\circ\text{C}$		290	
			$V_{OUT} = 3.3\text{ V}$, $-40^\circ\text{C} \leq T_J \leq 125^\circ\text{C}$	125	270	
			$V_{OUT} = 1.1\text{ V}$, $-40^\circ\text{C} \leq T_J \leq 150^\circ\text{C}$		560	
			$1.2\text{ V} \leq V_{OUT} < 1.5\text{ V}$, $-40^\circ\text{C} \leq T_J \leq 150^\circ\text{C}$		490	
			$1.5\text{ V} \leq V_{OUT} < 1.8\text{ V}$, $-40^\circ\text{C} \leq T_J \leq 150^\circ\text{C}$		440	
			$1.8\text{ V} \leq V_{OUT} < 2.5\text{ V}$, $-40^\circ\text{C} \leq T_J \leq 150^\circ\text{C}$		340	
			$2.5\text{ V} \leq V_{OUT} < 3.3\text{ V}$, $-40^\circ\text{C} \leq T_J \leq 150^\circ\text{C}$		330	
		$V_{OUT} = 3.3\text{ V}$, $-40^\circ\text{C} \leq T_J \leq 150^\circ\text{C}$		320		
I_{GND}	Ground pin current	$I_{OUT} = 0\text{ mA}$, $-40^\circ\text{C} \leq T_J \leq 125^\circ\text{C}$		34	62	μA
		$I_{OUT} = 0\text{ mA}$, $-40^\circ\text{C} \leq T_J \leq 150^\circ\text{C}$			78	
I_{SHDN}	Shutdown current	$V_{EN} \leq 0.35\text{ V}$, $2.0\text{ V} \leq V_{IN} \leq 5.5\text{ V}$, $T_J = 25^\circ\text{C}$		0.1	1	μA
PSRR	Power-supply rejection ratio	$V_{OUT} = 1.8\text{ V}$, $I_{OUT} = 300\text{ mA}$	$f = 100\text{ Hz}$	68		dB
			$f = 10\text{ kHz}$	35		
			$f = 100\text{ kHz}$	28		
V_n	Output noise voltage	$BW = 10\text{ Hz}$ to 100 kHz , $V_{OUT} = 1.8\text{ V}$, $I_{OUT} = 10\text{ mA}$		120		μV_{RMS}
$V_{EN(HI)}$	EN pin high voltage (enabled)		0.9			V
$V_{EN(LO)}$	EN pin low voltage (disabled)				0.35	V
I_{EN}	EN pin current	$V_{EN} = 5.5\text{ V}$		0.01		μA
	Pulldown resistor	$V_{IN} = 2.3\text{ V}$		120		Ω
I_{LIM}	Output current limit		360		700	mA
I_{OS}	Short-circuit current limit	V_{OUT} shorted to GND, $V_{OUT} = 1.0\text{ V}$		150		mA
		V_{OUT} shorted to GND, $V_{OUT} = 3.3\text{ V}$		170		
T_{sd}	Thermal shutdown	Shutdown, temperature increasing		160		$^\circ\text{C}$
		Reset, temperature decreasing		140		

(1) Dropout voltage for the TLV73310P is not valid at room temperature. The device engages undervoltage lockout ($V_{IN} < UVLO_{FALL}$) before the dropout condition is met.

6.6 Timing Requirements

			MIN	NOM	MAX	UNIT
t _{STR}	Startup time	Time from EN assertion to 98% × V _{OUT(nom)} , V _{OUT} = 1.0 V, I _{OUT} = 0 mA		250		μs
		Time from EN assertion to 98% × V _{OUT(nom)} , V _{OUT} = 3.3 V, I _{OUT} = 0 mA		800		

6.7 Typical Characteristics

at operating temperature range ($T_J = -40^{\circ}\text{C}$ to $+150^{\circ}\text{C}$), $V_{IN} = V_{OUT(nom)} + 0.5\text{ V}$ or 2.0 V (whichever is greater), $I_{OUT} = 1\text{ mA}$, $V_{EN} = V_{IN}$, and $C_{IN} = C_{OUT} = 1\text{ }\mu\text{F}$ (unless otherwise noted)

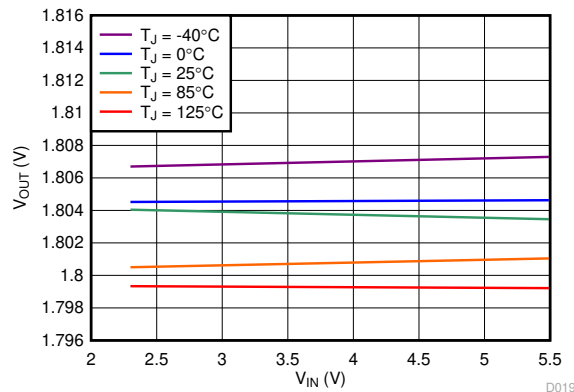

Figure 6-1. 1.8-V Regulation vs V_{IN} (Line Regulation) and Temperature

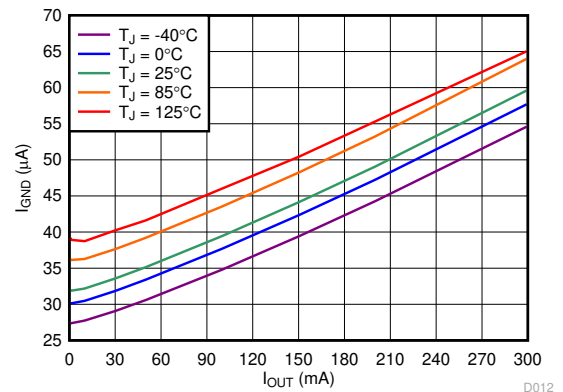

Figure 6-2. Ground Pin Current vs I_{OUT} and Temperature

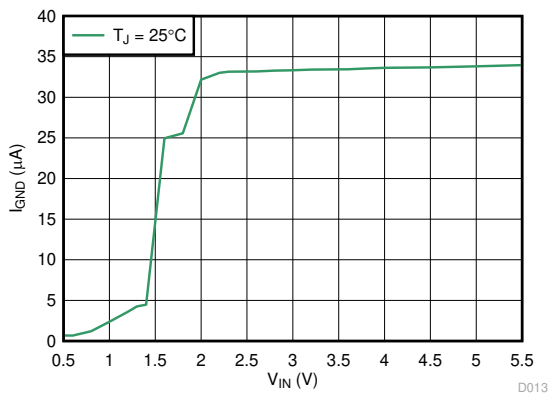

Figure 6-3. Ground Pin Current vs V_{IN}

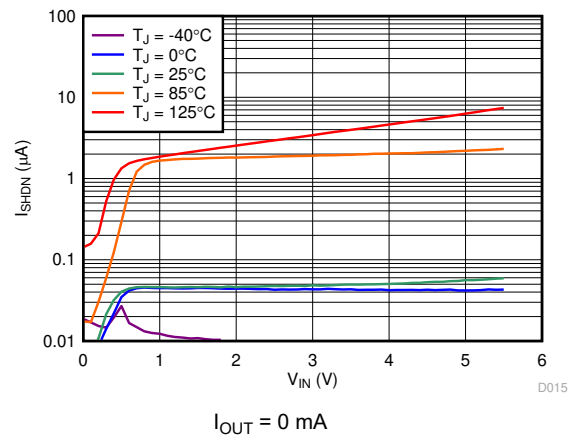

Figure 6-4. Shutdown Current vs V_{IN} and Temperature

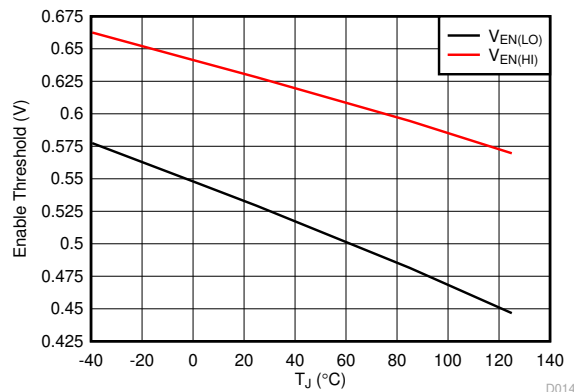

Figure 6-5. Enable Threshold vs Temperature

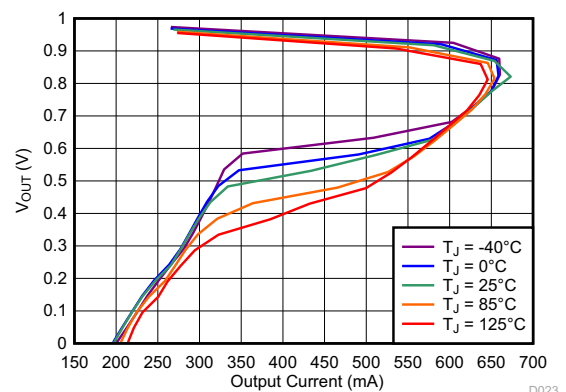

Figure 6-6. Output Voltage vs 1.0-V Foldback Current Limit and Temperature

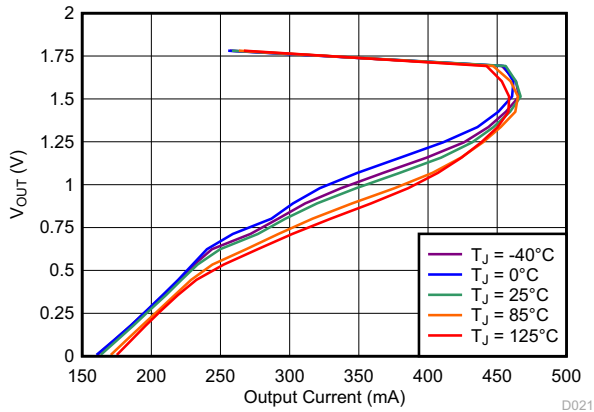

Figure 6-7. Output Voltage vs 1.8-V Foldback Current Limit and Temperature

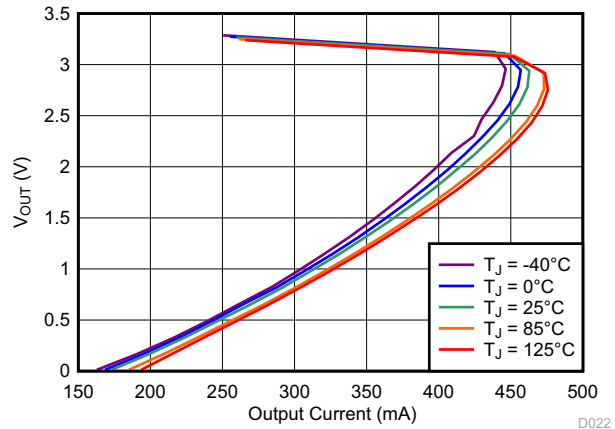

Figure 6-8. Output Voltage vs 3.3-V Foldback Current Limit and Temperature

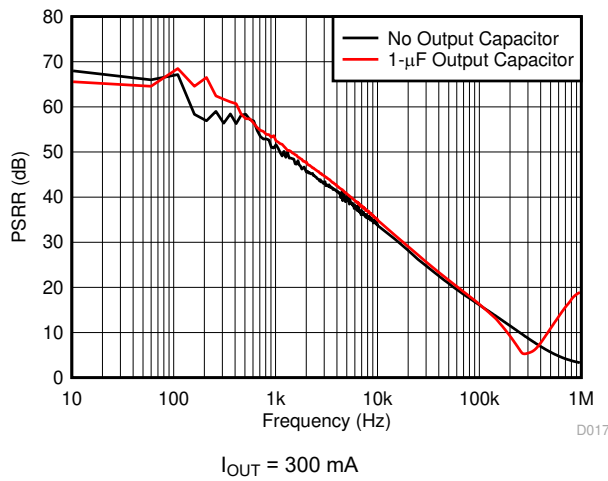

Figure 6-9. Power-Supply Rejection Ratio vs Frequency

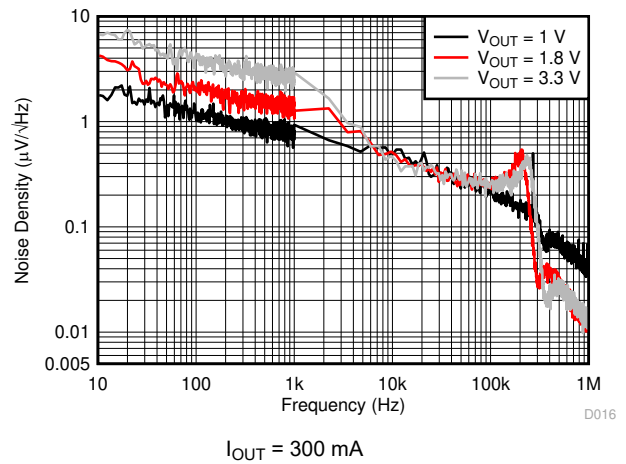

Figure 6-10. Output Spectral Noise Density vs Frequency and Output Voltage

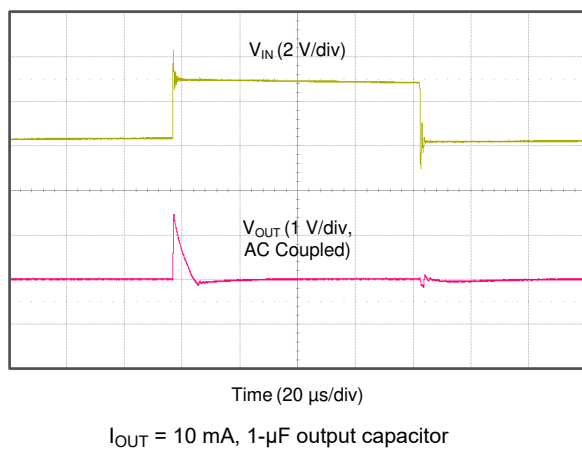

Figure 6-11. Line Transient

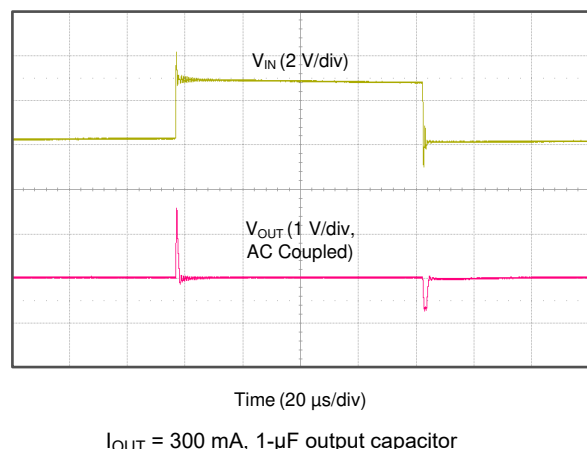
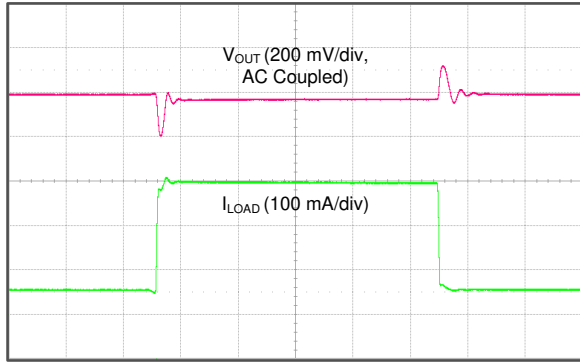

Figure 6-12. Line Transient



Time (20 μ s/div)

$V_{IN} = 2.0$ V, 1- μ F output capacitor, output current slew rate = 0.25 A/ μ s

Figure 6-13. 1.0-V, 50-mA to 300-mA Load Transient

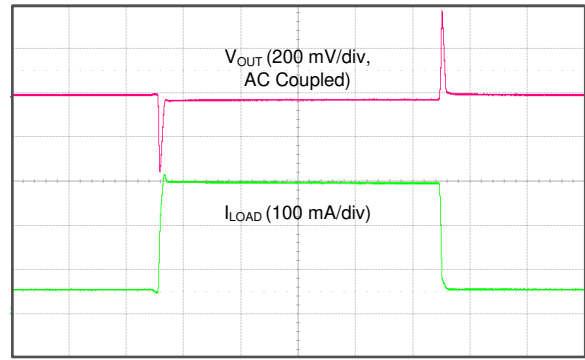

Time (20 μ s/div)

$V_{IN} = 2.0$ V, no output capacitor, output current slew rate = 0.25 A/ μ s

Figure 6-14. 1.0 V, 50-mA to 300-mA Load Transient

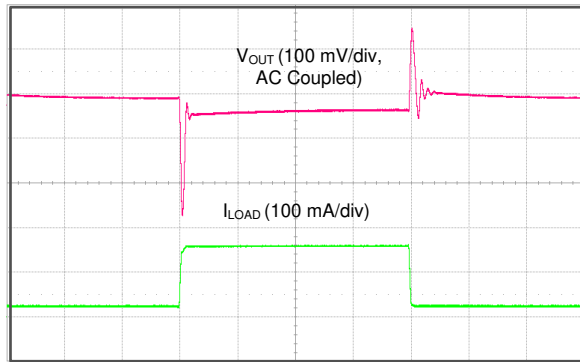

Time (20 μ s/div)

$V_{IN} = 3.8$ V, 1- μ F output capacitor, output current slew rate = 0.25 A/ μ s

Figure 6-15. 3.3 V, 50-mA to 300-mA Load Transient

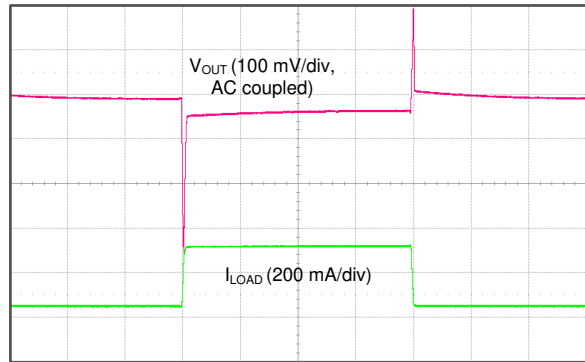

Time (50 μ s/div)

$V_{IN} = 3.8$ V, no output capacitor, output current slew rate = 0.25 A/ μ s

Figure 6-16. 3.3 V, 50-mA to 300-mA Load Transient

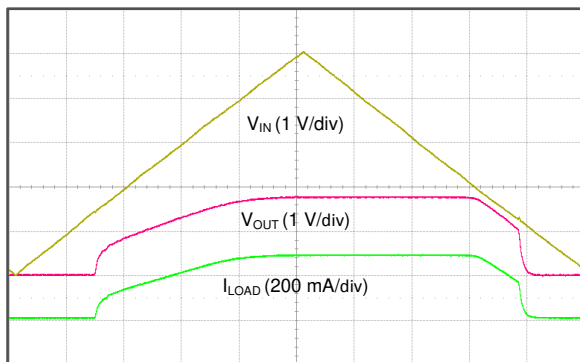

Time (100 μ s/div)

$R_L = 6.2$ Ω , $V_{EN} = V_{IN}$, 1- μ F output capacitor

Figure 6-17. V_{IN} Power-Up and Power-Down

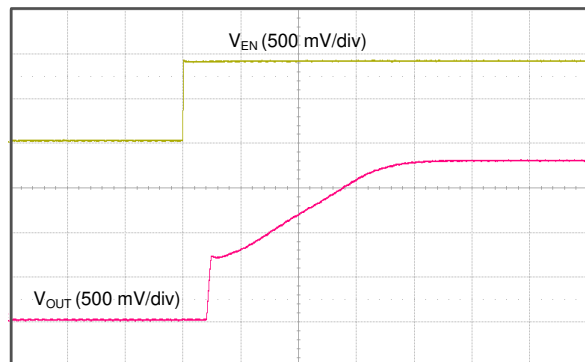

Time (100 μ s/div)

$R_L = 6.2$ Ω , 1- μ F output capacitor

Figure 6-18. Startup with EN

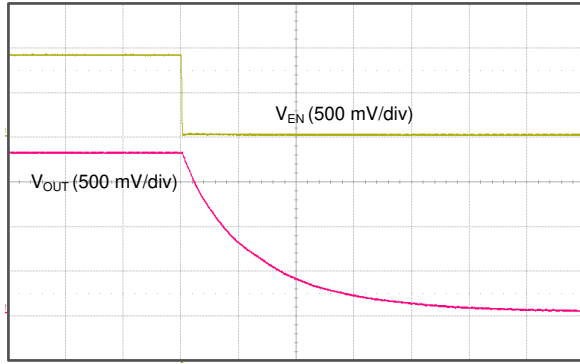

Time (100 μ s/div)

$I_{OUT} = 300$ mA, 1- μ F output capacitor

Figure 6-19. Shutdown Response with Enable

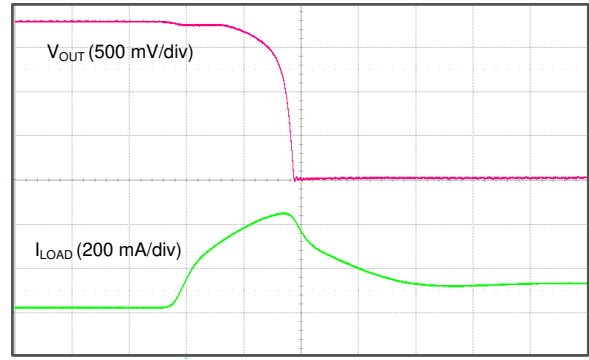

Time (100 μ s/div)

1- μ F output capacitor

Figure 6-20. Foldback Current Limit Response

7 Detailed Description

7.1 Overview

The TLV733P-Q1 belongs to a family of low dropout (LDO) linear regulators. These devices consume low quiescent current and deliver excellent line and load transient performance. These characteristics, combined with low noise and good PSRR with low dropout voltage, make this family of devices ideal for portable consumer applications.

This family of regulators offers foldback current limit, shutdown, and thermal protection. The operating junction temperature for this family of devices is -40°C to $+150^{\circ}\text{C}$.

7.2 Functional Block Diagram

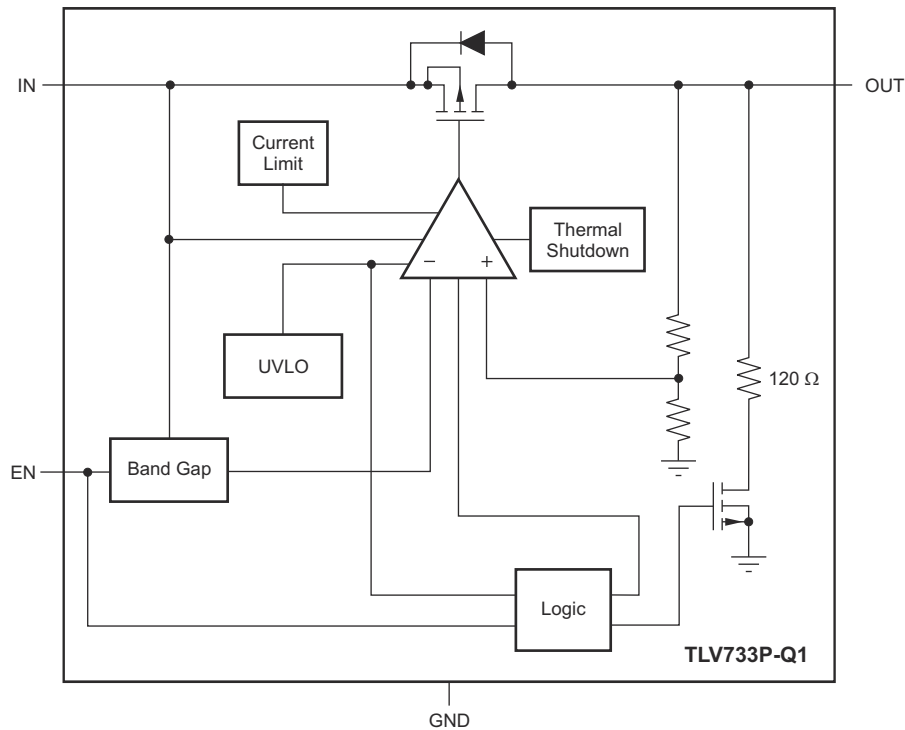

7.3 Feature Description

7.3.1 Undervoltage Lockout (UVLO)

The TLV733P-Q1 family uses an undervoltage lockout (UVLO) circuit that disables the output until the input voltage is greater than the rising UVLO voltage. This circuit ensures that the device does not exhibit any unpredictable behavior when the supply voltage is lower than the operational range of the internal circuitry. During UVLO disable, the output is connected to ground with a 120-Ω pulldown resistor.

7.3.2 Shutdown and Output Enable

The enable pin (EN) is active high. Enable the device by forcing the EN pin to exceed $V_{EN(HI)}$. Turn off the device by forcing the EN pin to drop below $V_{EN(LO)}$. If shutdown capability is not required, connect EN to IN. There is no internal pulldown resistor connected to the EN pin.

The TLV733P-Q1 has an internal pulldown MOSFET that connects a 120-Ω resistor to ground when the device is disabled. The discharge time after disabling depends on the output capacitance (C_{OUT}) and the load resistance (R_L) in parallel with the 120-Ω pulldown resistor. The time constant is calculated in [Equation 1](#):

$$\tau = \frac{120 \cdot R_L}{120 + R_L} \cdot C_{OUT} \quad (1)$$

7.3.3 Internal Foldback Current Limit

The TLV733P-Q1 has an internal foldback current limit that protects the regulator during fault conditions. The current allowed through the device is reduced when the output voltage falls. When the output is shorted, the LDO supplies a typical current of 150 mA. The output voltage is not regulated when the device is in current limit. In this condition, the output voltage is the product of the regulated current and the load resistance. When the device output is shorted, the PMOS pass transistor dissipates power $[(V_{IN} - V_{OUT}) \times I_{OS}]$ until thermal shutdown is triggered and the device turns off. After the device cools down, the internal thermal shutdown circuit turns the device back on. If the fault condition continues, the device cycles between current limit and thermal shutdown; see the [Thermal Information](#) table for more details.

The foldback current-limit circuit limits the current allowed through the device to current levels lower than the minimum current limit at a nominal V_{OUT} current limit (I_{LIM}) during startup. See [Figure 6-6](#) to [Figure 6-8](#) for typical foldback current limit values. If the output is loaded by a constant-current load during startup, or if the output voltage is negative when the device is enabled, then the load current demanded by the load can exceed the foldback current limit and the device may not rise to the full output voltage. For constant-current loads, disable the output load until the TLV733P-Q1 has fully risen to the nominal output voltage.

The TLV733P-Q1 PMOS pass element has an intrinsic body diode that conducts current when the voltage at the OUT pin exceeds the voltage at the IN pin. Do not force the output voltage to exceed the input voltage because excessively high current can flow through the body diode.

7.3.4 Thermal Shutdown

Thermal shutdown protection disables the output when the junction temperature rises to approximately 160°C. Disabling the device eliminates the power dissipated by the device, allowing the device to cool. When the junction temperature cools to approximately 140°C, the output circuitry is again enabled. Depending on power dissipation, thermal resistance, and ambient temperature, the thermal protection circuit can cycle on and off. This cycling limits regulator dissipation, protecting the device from damage as a result of overheating.

Activating the thermal shutdown feature usually indicates excessive power dissipation as a result of the product of the $(V_{IN} - V_{OUT})$ voltage and the load current. For reliable operation, limit junction temperature to 150°C (maximum). To estimate the margin of safety in a complete design, increase the ambient temperature until the thermal protection is triggered; use worst-case loads and signal conditions.

The TLV733P-Q1 internal protection circuitry protects against overload conditions but is not intended to be activated in normal operation. Continuously running the TLV733P-Q1 into thermal shutdown degrades device reliability.

7.4 Device Functional Modes

7.4.1 Normal Operation

The device regulates to the nominal output voltage under the following conditions:

- The input voltage has previously exceeded the UVLO rising voltage and has not decreased below the UVLO falling threshold.
- The input voltage is greater than the nominal output voltage added to the dropout voltage.
- The enable voltage has previously exceeded the enable rising threshold voltage and has not decreased below the enable falling threshold.
- The output current is less than the current limit.
- The device junction temperature is less than the thermal shutdown temperature.

7.4.2 Dropout Operation

If the input voltage is lower than the nominal output voltage plus the specified dropout voltage, but all other conditions are met for normal operation, the device operates in dropout mode. In this condition, the output voltage is the same as the input voltage minus the dropout voltage. The transient performance of the device is significantly degraded because the pass device is in a triode state and no longer controls the current through the LDO. Line or load transients in dropout can result in large output voltage deviations.

7.4.3 Disabled

The device is disabled under the following conditions:

- The input voltage is less than the UVLO falling voltage, or has not yet exceeded the UVLO rising threshold.
- The enable voltage is less than the enable falling threshold voltage or has not yet exceeded the enable rising threshold.
- The device junction temperature is greater than the thermal shutdown temperature.

When the device is disabled, the active pulldown resistor discharges the output.

Table 7-1 shows the conditions that lead to the different modes of operation.

Table 7-1. Device Functional Mode Comparison

OPERATING MODE	PARAMETER			
	V _{IN}	V _{EN}	I _{OUT}	T _J
Normal mode	V _{IN} > V _{OUT(nom)} + V _{DO} and V _{IN} > UVLO _{RISE}	V _{EN} > V _{EN(HI)}	I _{OUT} < I _{LIM}	T _J < 160°C
Dropout mode	UVLO _{RISE} < V _{IN} < V _{OUT(nom)} + V _{DO}	V _{EN} > V _{EN(HI)}	I _{OUT} < I _{LIM}	T _J < 160°C
Disabled mode (any true condition disables the device)	V _{IN} < UVLO _{FALL}	V _{EN} < V _{EN(LO)}	—	T _J > 160°C

8 Application and Implementation

Note

Information in the following applications sections is not part of the TI component specification, and TI does not warrant its accuracy or completeness. TI's customers are responsible for determining suitability of components for their purposes. Customers should validate and test their design implementation to confirm system functionality.

8.1 Application Information

8.1.1 Input and Output Capacitor Selection

The TLV733P-Q1 uses an advanced internal control loop to obtain stable operation both with and without the use of input or output capacitors. Dynamic performance is improved with the use of an output capacitor, and can be improved with an input capacitor. An output capacitance of 0.1 μF or larger generally provides good dynamic response. Use X5R- and X7R-type ceramic capacitors because these capacitors have minimal variation in value and equivalent series resistance (ESR) over temperature.

Although an input capacitor is not required for stability, increased output impedance from the input supply can compromise the performance of the TLV733P-Q1. Good analog design practice is to connect a 0.1- μF to 1- μF capacitor from IN to GND. This capacitor counteracts reactive input sources and improves transient response, input ripple, and PSRR. Use an input capacitor if the source impedance is greater than 0.5 Ω . Use a higher-value capacitor if large, fast rise-time load transients are anticipated, or if the device is located several inches from the input power source.

Figure 8-1 shows the transient performance improvements with an external 1- μF capacitor on the output versus no output capacitor. The data in this figure are taken with an increasing load step from 50 mA to 300 mA, and the peak output voltage deviation (load transient response) is measured. For low output current slew rates, ($< 0.1 \text{ A}/\mu\text{s}$), the transient performance of the device is similar with or without an output capacitor. When the current slew rate is increased, the peak voltage deviation is significantly increased. For loads that exhibit fast current slew rates above 0.1 $\text{A}/\mu\text{s}$, use an output capacitor. For best performance, the maximum recommended output capacitance is 100 μF .

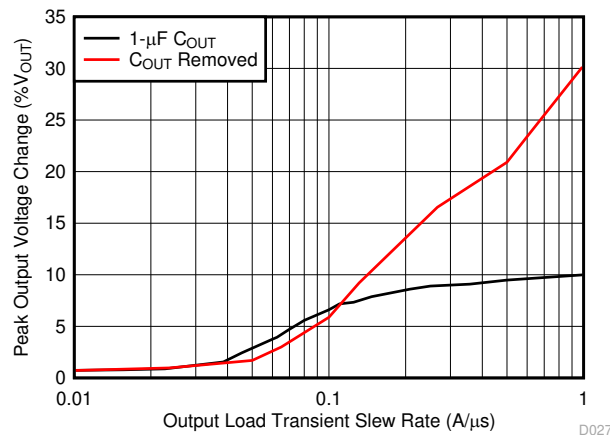

Output current stepped from 50 mA to 300 mA, output voltage change measured at positive di/dt

Figure 8-1. Output Voltage Deviation vs Load Step Slew Rate

Some applications benefit from the removal of the output capacitor. In addition to space and cost savings, the removal of the output capacitor lowers inrush current as a result of eliminating the required current flow into the output capacitor at startup. In these cases, take care to ensure that the load is tolerant of the additional output voltage deviations.

8.1.2 Dropout Voltage

The TLV733P-Q1 uses a PMOS pass transistor to achieve low dropout. When $(V_{IN} - V_{OUT})$ is less than the dropout voltage (V_{DO}), the PMOS pass device is in the linear region of operation and the input-to-output resistance is the $R_{DS(ON)}$ of the PMOS pass element. V_{DO} scales approximately with output current because the PMOS device behaves like a resistor in dropout mode. As with any linear regulator, PSRR and transient response degrade when $(V_{IN} - V_{OUT})$ approaches dropout operation.

8.2 Typical Applications

8.2.1 DC-DC Converter Post Regulation

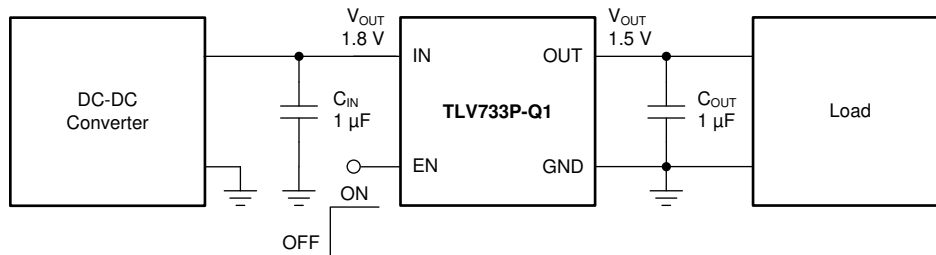

Figure 8-2. DC-DC Converter Post Regulation

8.2.1.1 Design Requirements

Table 8-1. Design Parameters

PARAMETER	DESIGN REQUIREMENT
Input voltage	1.8 V, $\pm 5\%$
Output voltage	1.5 V, $\pm 1\%$
Output current	200-mA dc, 300-mA peak
Output voltage transient deviation	< 10%, 1-A/ μ s load step from 50 mA to 200 mA
Maximum ambient temperature	85°C

8.2.1.2 Design Considerations

The TLV733P-Q1 can provide post regulation after a dc-dc converter, as shown in Figure 8-2. For this application, input and output capacitors are required to achieve the output voltage transient requirements. Capacitance values of 1 μ F are selected to give the maximum output capacitance in a small, low-cost package.

8.2.1.3 Application Curve

Figure 8-3 shows the TLV733P-Q1 startup, regulation, and shutdown as specified in Figure 8-2.

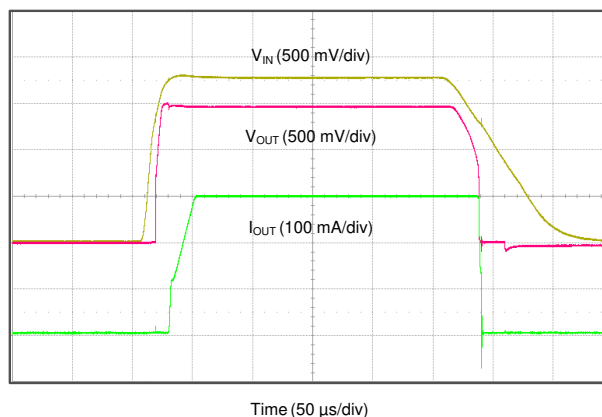

Figure 8-3. 1.8-V to 1.5-V Regulation at 300 mA

8.2.2 Capacitor-Free Operation from a Battery Input Supply

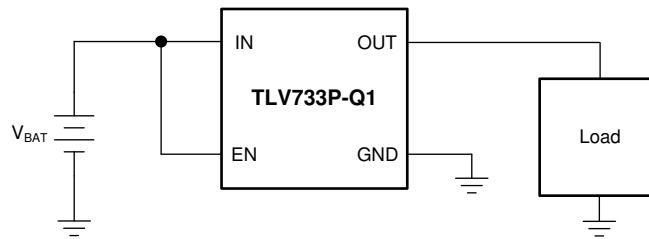

Figure 8-4. Capacitor-Free Operation from a Battery Input Supply

8.2.2.1 Design Requirements

Table 8-2. Design Parameters

PARAMETER	DESIGN REQUIREMENT
Input voltage	3.0 V to 1.8 V (two 1.5-V batteries)
Output voltage	1.0 V, $\pm 1\%$
Input current	200 mA, maximum
Output load	100-mA dc
Maximum ambient temperature	70°C

8.2.2.2 Design Considerations

The TLV733P-Q1 can be directly powered off of a battery, as shown in [Figure 8-4](#). An input capacitor is not required for this design because of the direct low impedance connection to the battery.

Eliminating the output capacitor allows for the minimal possible inrush current during startup, ensuring that the 200-mA maximum input current is not exceeded.

8.2.2.3 Application Curve

[Figure 8-5](#) shows no inrush with the capacitor-free startup.

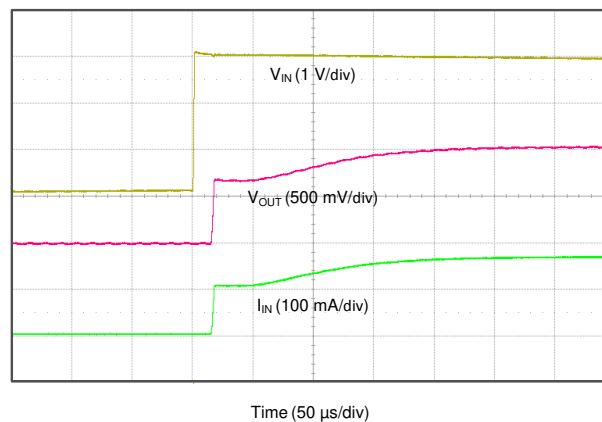

Figure 8-5. No Inrush Startup, 3.0-V to 1.0-V Regulation

Power Supply Recommendations

Connect a low output impedance power supply directly to the IN pin of the TLV733P-Q1. Inductive impedances between the input supply and the IN pin can create significant voltage excursions at the IN pin during startup or load transient events. If inductive impedances are unavoidable, use an input capacitor.

9 Layout

9.1 Layout Guidelines

- Place input and output capacitors as close to the device as possible.
- Use copper planes for device connections, in order to optimize thermal performance.
- Place thermal vias around the device to distribute the heat.

Figure 9-1 and Figure 9-2 show examples of how the TLV733P-Q1 is laid out on a printed circuit board (PCB).

9.2 Layout Examples

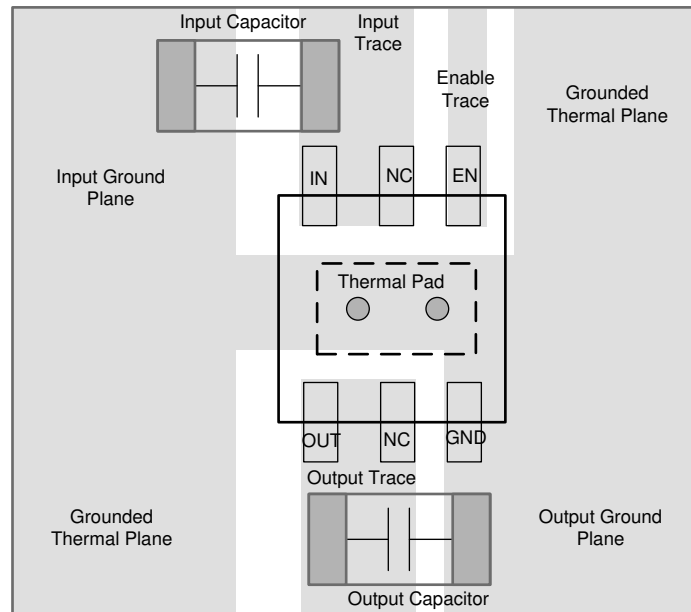

● Designates thermal vias.

Figure 9-1. WSON Layout Example

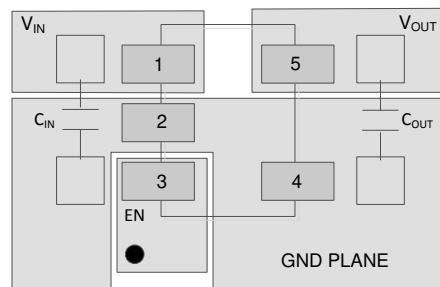

● Represents via used for application specific connections

Figure 9-2. SOT-23 Layout Example

10 Device and Documentation Support

10.1 Device Support

10.1.1 Development Support

10.1.1.1 Evaluation Module

An evaluation module (EVM) is available to assist in the initial circuit performance evaluation using the TLV733P-Q1. The [TLV73312PEVM-643 evaluation module](#) (and [related user guide](#)) can be requested at the Texas Instruments website through the product folders or purchased directly from the [TI eStore](#).

10.1.2 Device Nomenclature

Table 10-1. Device Nomenclature (1) (2)

PRODUCT	V _{OUT}
TLV733P-Q1xx(x)PyyyzQ1	<p>xx(x) is the nominal output voltage. For output voltages with a resolution of 100 mV, two digits are used in the ordering number; otherwise, three digits are used (for example, 28 = 2.8 V; 125 = 1.25 V).</p> <p>P indicates an active output discharge feature. All members of the TLV733P-Q1 family will actively discharge the output when the device is disabled.</p> <p>yyy is the package designator.</p> <p>z is the package quantity. R is for reel (3000 pieces), T is for tape (250 pieces).</p>

- (1) For the most current package and ordering information see the Package Option Addendum at the end of this document, or visit the device product folder on [www.ti.com](#).
- (2) Output voltages from 1.0 V to 3.3 V in 50-mV increments are available. Contact the factory for details and availability.

10.2 Receiving Notification of Documentation Updates

To receive notification of documentation updates, navigate to the device product folder on [ti.com](#). Click on *Subscribe to updates* to register and receive a weekly digest of any product information that has changed. For change details, review the revision history included in any revised document.

10.3 Support Resources

[TI E2E™ support forums](#) are an engineer's go-to source for fast, verified answers and design help — straight from the experts. Search existing answers or ask your own question to get the quick design help you need.

Linked content is provided "AS IS" by the respective contributors. They do not constitute TI specifications and do not necessarily reflect TI's views; see TI's [Terms of Use](#).

10.4 Trademarks

TI E2E™ is a trademark of Texas Instruments.

All other trademarks are the property of their respective owners.

10.5 Electrostatic Discharge Caution



This integrated circuit can be damaged by ESD. Texas Instruments recommends that all integrated circuits be handled with appropriate precautions. Failure to observe proper handling and installation procedures can cause damage.

ESD damage can range from subtle performance degradation to complete device failure. Precision integrated circuits may be more susceptible to damage because very small parametric changes could cause the device not to meet its published specifications.

10.6 Glossary

[TI Glossary](#) This glossary lists and explains terms, acronyms, and definitions.

Mechanical, Packaging, and Orderable Information

The following pages include mechanical, packaging, and orderable information. This information is the most current data available for the designated devices. This data is subject to change without notice and revision of this document. For browser-based versions of this data sheet, refer to the left-hand navigation.

PACKAGING INFORMATION

Orderable Device	Status (1)	Package Type	Package Drawing	Pins	Package Qty	Eco Plan (2)	Lead finish/ Ball material (6)	MSL Peak Temp (3)	Op Temp (°C)	Device Marking (4/5)	Samples
TLV73310PQDBVRQ1	ACTIVE	SOT-23	DBV	5	3000	RoHS & Green	NIPDAU SN	Level-1-260C-UNLIM	-40 to 125	1P5F	Samples
TLV73310PQDRVRQ1	ACTIVE	WSON	DRV	6	3000	RoHS & Green	NIPDAUAG	Level-1-260C-UNLIM	-40 to 150	12P	Samples
TLV73311PQDBVRQ1	ACTIVE	SOT-23	DBV	5	3000	RoHS & Green	NIPDAU SN	Level-1-260C-UNLIM	-40 to 125	1P6F	Samples
TLV73311PQDRVRQ1	ACTIVE	WSON	DRV	6	3000	RoHS & Green	NIPDAUAG	Level-1-260C-UNLIM	-40 to 150	12Q	Samples
TLV73312PQDBVRQ1	ACTIVE	SOT-23	DBV	5	3000	RoHS & Green	NIPDAU	Level-1-260C-UNLIM	-40 to 125	1P7F	Samples
TLV73312PQDRVRQ1	ACTIVE	WSON	DRV	6	3000	RoHS & Green	NIPDAUAG	Level-1-260C-UNLIM	-40 to 150	12R	Samples
TLV73315PQDBVRQ1	ACTIVE	SOT-23	DBV	5	3000	RoHS & Green	NIPDAU SN	Level-1-260C-UNLIM	-40 to 125	1P8F	Samples
TLV73315PQDRVRQ1	ACTIVE	WSON	DRV	6	3000	RoHS & Green	NIPDAUAG	Level-1-260C-UNLIM	-40 to 150	12S	Samples
TLV73318PQDBVRQ1	ACTIVE	SOT-23	DBV	5	3000	RoHS & Green	NIPDAU	Level-1-260C-UNLIM	-40 to 125	1P9F	Samples
TLV73318PQDRVRQ1	ACTIVE	WSON	DRV	6	3000	RoHS & Green	NIPDAUAG	Level-1-260C-UNLIM	-40 to 150	12T	Samples
TLV73325PQDBVRQ1	ACTIVE	SOT-23	DBV	5	3000	RoHS & Green	NIPDAU	Level-1-260C-UNLIM	-40 to 125	1PAF	Samples
TLV73325PQDRVRQ1	ACTIVE	WSON	DRV	6	3000	RoHS & Green	NIPDAUAG	Level-1-260C-UNLIM	-40 to 150	12U	Samples
TLV73328PQDBVRQ1	ACTIVE	SOT-23	DBV	5	3000	RoHS & Green	NIPDAU	Level-1-260C-UNLIM	-40 to 125	1PBF	Samples
TLV73328PQDRVRQ1	ACTIVE	WSON	DRV	6	3000	RoHS & Green	NIPDAUAG	Level-1-260C-UNLIM	-40 to 150	12V	Samples
TLV73330PQDBVRQ1	ACTIVE	SOT-23	DBV	5	3000	RoHS & Green	NIPDAU SN	Level-1-260C-UNLIM	-40 to 125	1PCF	Samples
TLV73333PQDBVRQ1	ACTIVE	SOT-23	DBV	5	3000	RoHS & Green	NIPDAU SN	Level-1-260C-UNLIM	-40 to 125	1PDF	Samples
TLV73333PQDRVRQ1	ACTIVE	WSON	DRV	6	3000	RoHS & Green	NIPDAUAG	Level-1-260C-UNLIM	-40 to 150	12W	Samples

(1) The marketing status values are defined as follows:

ACTIVE: Product device recommended for new designs.

LIFEBUY: TI has announced that the device will be discontinued, and a lifetime-buy period is in effect.

NRND: Not recommended for new designs. Device is in production to support existing customers, but TI does not recommend using this part in a new design.

PREVIEW: Device has been announced but is not in production. Samples may or may not be available.

OBSOLETE: TI has discontinued the production of the device.

(2) **RoHS:** TI defines "RoHS" to mean semiconductor products that are compliant with the current EU RoHS requirements for all 10 RoHS substances, including the requirement that RoHS substance do not exceed 0.1% by weight in homogeneous materials. Where designed to be soldered at high temperatures, "RoHS" products are suitable for use in specified lead-free processes. TI may reference these types of products as "Pb-Free".

RoHS Exempt: TI defines "RoHS Exempt" to mean products that contain lead but are compliant with EU RoHS pursuant to a specific EU RoHS exemption.

Green: TI defines "Green" to mean the content of Chlorine (Cl) and Bromine (Br) based flame retardants meet JS709B low halogen requirements of ≤ 1000 ppm threshold. Antimony trioxide based flame retardants must also meet the ≤ 1000 ppm threshold requirement.

(3) MSL, Peak Temp. - The Moisture Sensitivity Level rating according to the JEDEC industry standard classifications, and peak solder temperature.

(4) There may be additional marking, which relates to the logo, the lot trace code information, or the environmental category on the device.

(5) Multiple Device Markings will be inside parentheses. Only one Device Marking contained in parentheses and separated by a "~" will appear on a device. If a line is indented then it is a continuation of the previous line and the two combined represent the entire Device Marking for that device.

(6) Lead finish/Ball material - Orderable Devices may have multiple material finish options. Finish options are separated by a vertical ruled line. Lead finish/Ball material values may wrap to two lines if the finish value exceeds the maximum column width.

Important Information and Disclaimer:The information provided on this page represents TI's knowledge and belief as of the date that it is provided. TI bases its knowledge and belief on information provided by third parties, and makes no representation or warranty as to the accuracy of such information. Efforts are underway to better integrate information from third parties. TI has taken and continues to take reasonable steps to provide representative and accurate information but may not have conducted destructive testing or chemical analysis on incoming materials and chemicals. TI and TI suppliers consider certain information to be proprietary, and thus CAS numbers and other limited information may not be available for release.

In no event shall TI's liability arising out of such information exceed the total purchase price of the TI part(s) at issue in this document sold by TI to Customer on an annual basis.

OTHER QUALIFIED VERSIONS OF TLV733P-Q1 :

- Catalog : [TLV733P](#)

NOTE: Qualified Version Definitions:

- Catalog - TI's standard catalog product

TAPE AND REEL INFORMATION

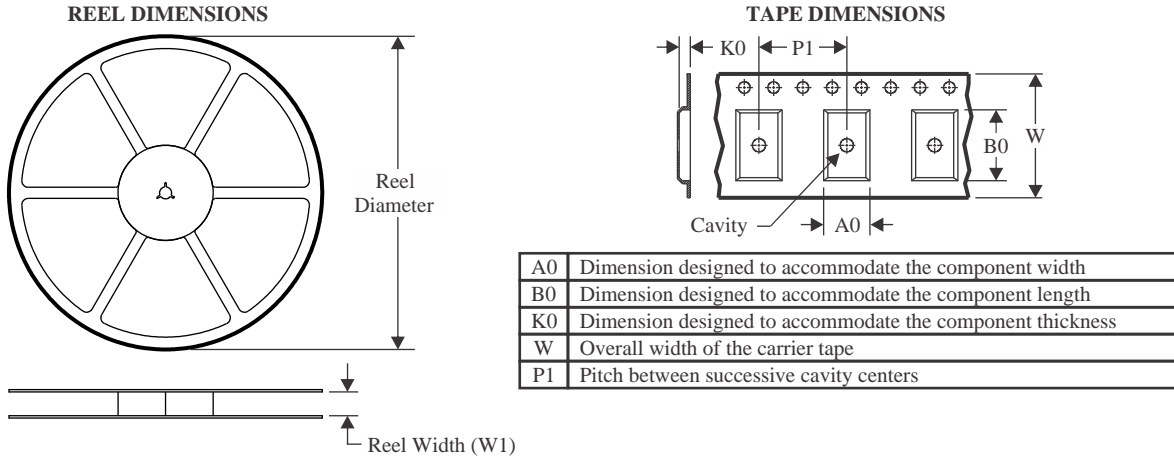

QUADRANT ASSIGNMENTS FOR PIN 1 ORIENTATION IN TAPE

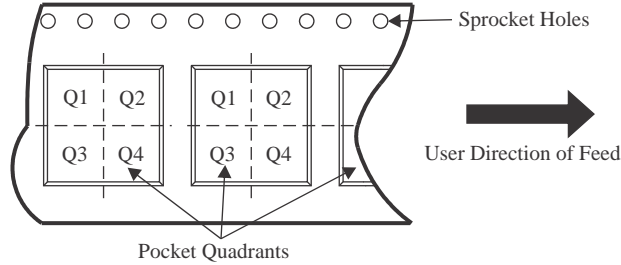

*All dimensions are nominal

Device	Package Type	Package Drawing	Pins	SPQ	Reel Diameter (mm)	Reel Width W1 (mm)	A0 (mm)	B0 (mm)	K0 (mm)	P1 (mm)	W (mm)	Pin1 Quadrant
TLV73310PQDBVRQ1	SOT-23	DBV	5	3000	180.0	8.4	3.2	3.2	1.4	4.0	8.0	Q3
TLV73310PQDRVRQ1	WSO	DRV	6	3000	179.0	8.4	2.2	2.2	1.2	4.0	8.0	Q2
TLV73311PQDBVRQ1	SOT-23	DBV	5	3000	180.0	8.4	3.2	3.2	1.4	4.0	8.0	Q3
TLV73311PQDRVRQ1	WSO	DRV	6	3000	179.0	8.4	2.2	2.2	1.2	4.0	8.0	Q2
TLV73312PQDBVRQ1	SOT-23	DBV	5	3000	180.0	8.4	3.2	3.2	1.4	4.0	8.0	Q3
TLV73312PQDRVRQ1	WSO	DRV	6	3000	179.0	8.4	2.2	2.2	1.2	4.0	8.0	Q2
TLV73315PQDBVRQ1	SOT-23	DBV	5	3000	180.0	8.4	3.2	3.2	1.4	4.0	8.0	Q3
TLV73315PQDRVRQ1	WSO	DRV	6	3000	179.0	8.4	2.2	2.2	1.2	4.0	8.0	Q2
TLV73318PQDBVRQ1	SOT-23	DBV	5	3000	180.0	8.4	3.2	3.2	1.4	4.0	8.0	Q3
TLV73318PQDBVRQ1	SOT-23	DBV	5	3000	180.0	8.4	3.2	3.2	1.4	4.0	8.0	Q3
TLV73318PQDRVRQ1	WSO	DRV	6	3000	179.0	8.4	2.2	2.2	1.2	4.0	8.0	Q2
TLV73325PQDBVRQ1	SOT-23	DBV	5	3000	180.0	8.4	3.2	3.2	1.4	4.0	8.0	Q3
TLV73325PQDBVRQ1	SOT-23	DBV	5	3000	180.0	8.4	3.2	3.2	1.4	4.0	8.0	Q3
TLV73325PQDRVRQ1	WSO	DRV	6	3000	179.0	8.4	2.2	2.2	1.2	4.0	8.0	Q2
TLV73328PQDBVRQ1	SOT-23	DBV	5	3000	180.0	8.4	3.2	3.2	1.4	4.0	8.0	Q3
TLV73328PQDRVRQ1	WSO	DRV	6	3000	179.0	8.4	2.2	2.2	1.2	4.0	8.0	Q2

Device	Package Type	Package Drawing	Pins	SPQ	Reel Diameter (mm)	Reel Width W1 (mm)	A0 (mm)	B0 (mm)	K0 (mm)	P1 (mm)	W (mm)	Pin1 Quadrant
TLV73330PQDBVRQ1	SOT-23	DBV	5	3000	180.0	8.4	3.2	3.2	1.4	4.0	8.0	Q3
TLV73333PQDBVRQ1	SOT-23	DBV	5	3000	180.0	8.4	3.2	3.2	1.4	4.0	8.0	Q3
TLV73333PQDBVRQ1	SOT-23	DBV	5	3000	180.0	8.4	3.2	3.2	1.4	4.0	8.0	Q3
TLV73333PQDRVRQ1	WSON	DRV	6	3000	180.0	8.4	2.2	2.2	1.2	4.0	8.0	Q2

TAPE AND REEL BOX DIMENSIONS



*All dimensions are nominal

Device	Package Type	Package Drawing	Pins	SPQ	Length (mm)	Width (mm)	Height (mm)
TLV73310PQDBVRQ1	SOT-23	DBV	5	3000	210.0	185.0	35.0
TLV73310PQDRVRQ1	WSON	DRV	6	3000	200.0	183.0	25.0
TLV73311PQDBVRQ1	SOT-23	DBV	5	3000	210.0	185.0	35.0
TLV73311PQDRVRQ1	WSON	DRV	6	3000	200.0	183.0	25.0
TLV73312PQDBVRQ1	SOT-23	DBV	5	3000	210.0	185.0	35.0
TLV73312PQDRVRQ1	WSON	DRV	6	3000	200.0	183.0	25.0
TLV73315PQDBVRQ1	SOT-23	DBV	5	3000	210.0	185.0	35.0
TLV73315PQDRVRQ1	WSON	DRV	6	3000	200.0	183.0	25.0
TLV73318PQDBVRQ1	SOT-23	DBV	5	3000	210.0	185.0	35.0
TLV73318PQDBVRQ1	SOT-23	DBV	5	3000	210.0	185.0	35.0
TLV73318PQDRVRQ1	WSON	DRV	6	3000	200.0	183.0	25.0
TLV73325PQDBVRQ1	SOT-23	DBV	5	3000	210.0	185.0	35.0
TLV73325PQDBVRQ1	SOT-23	DBV	5	3000	210.0	185.0	35.0
TLV73325PQDRVRQ1	WSON	DRV	6	3000	200.0	183.0	25.0
TLV73328PQDBVRQ1	SOT-23	DBV	5	3000	210.0	185.0	35.0
TLV73328PQDRVRQ1	WSON	DRV	6	3000	200.0	183.0	25.0
TLV73330PQDBVRQ1	SOT-23	DBV	5	3000	210.0	185.0	35.0
TLV73333PQDBVRQ1	SOT-23	DBV	5	3000	210.0	185.0	35.0

Device	Package Type	Package Drawing	Pins	SPQ	Length (mm)	Width (mm)	Height (mm)
TLV73333PQDBVRQ1	SOT-23	DBV	5	3000	210.0	185.0	35.0
TLV73333PQDRVRQ1	WSON	DRV	6	3000	200.0	183.0	25.0

EXAMPLE BOARD LAYOUT

DBV0005A

SOT-23 - 1.45 mm max height

SMALL OUTLINE TRANSISTOR



LAND PATTERN EXAMPLE
EXPOSED METAL SHOWN
SCALE:15X



SOLDER MASK DETAILS

4214839/K 08/2024

NOTES: (continued)

- 6. Publication IPC-7351 may have alternate designs.
- 7. Solder mask tolerances between and around signal pads can vary based on board fabrication site.

EXAMPLE STENCIL DESIGN

DBV0005A

SOT-23 - 1.45 mm max height

SMALL OUTLINE TRANSISTOR



SOLDER PASTE EXAMPLE
BASED ON 0.125 mm THICK STENCIL
SCALE:15X

4214839/K 08/2024

NOTES: (continued)

8. Laser cutting apertures with trapezoidal walls and rounded corners may offer better paste release. IPC-7525 may have alternate design recommendations.
9. Board assembly site may have different recommendations for stencil design.

GENERIC PACKAGE VIEW

DRV 6

WSON - 0.8 mm max height

PLASTIC SMALL OUTLINE - NO LEAD



Images above are just a representation of the package family, actual package may vary.
Refer to the product data sheet for package details.

4206925/F

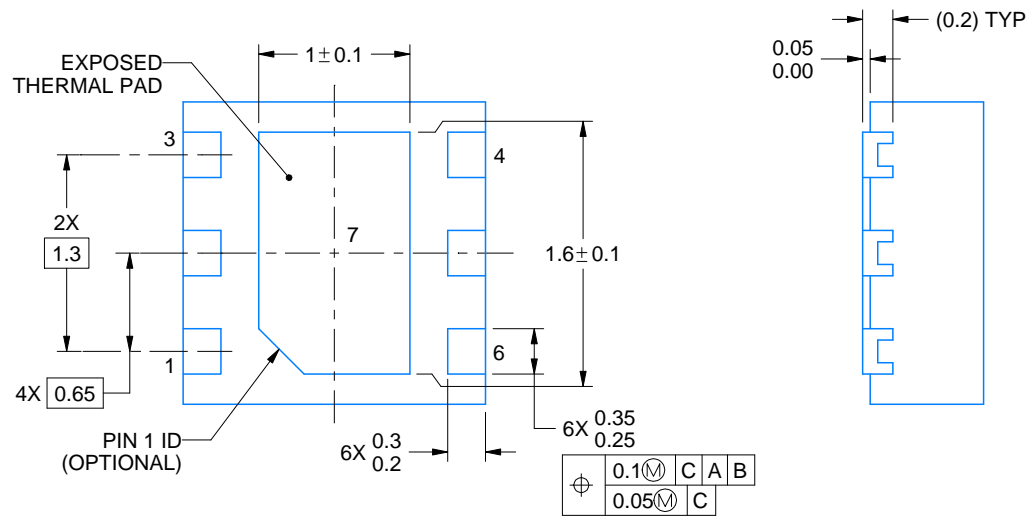
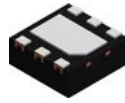

4225563/A 12/2019

NOTES:

1. All linear dimensions are in millimeters. Any dimensions in parenthesis are for reference only. Dimensioning and tolerancing per ASME Y14.5M.
2. This drawing is subject to change without notice.
3. The package thermal pad must be soldered to the printed circuit board for thermal and mechanical performance.

EXAMPLE BOARD LAYOUT

DRV0006D

WSON - 0.8 mm max height

PLASTIC SMALL OUTLINE - NO LEAD



LAND PATTERN EXAMPLE
EXPOSED METAL SHOWN
SCALE:25X

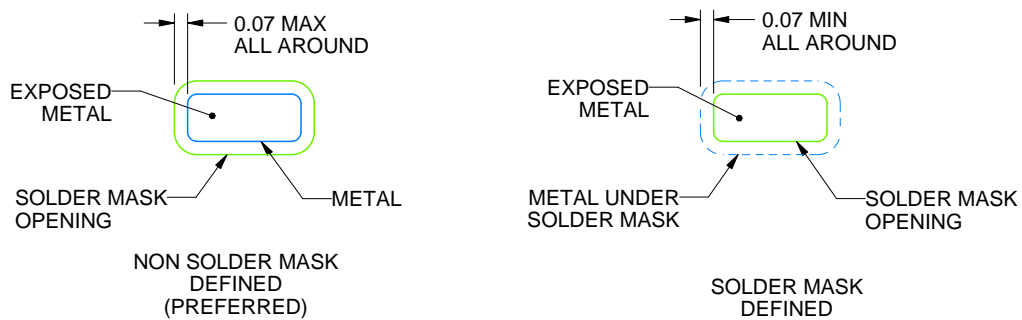

SOLDER MASK DETAILS

4225563/A 12/2019

NOTES: (continued)

4. This package is designed to be soldered to a thermal pad on the board. For more information, see Texas Instruments literature number SLUA271 (www.ti.com/lit/sluea271).
5. Vias are optional depending on application, refer to device data sheet. If some or all are implemented, recommended via locations are shown.

EXAMPLE STENCIL DESIGN

DRV0006D

WSON - 0.8 mm max height

PLASTIC SMALL OUTLINE - NO LEAD



SOLDER PASTE EXAMPLE
BASED ON 0.125 mm THICK STENCIL

EXPOSED PAD #7
88% PRINTED SOLDER COVERAGE BY AREA UNDER PACKAGE
SCALE:30X

4225563/A 12/2019

NOTES: (continued)

6. Laser cutting apertures with trapezoidal walls and rounded corners may offer better paste release. IPC-7525 may have alternate design recommendations.

IMPORTANT NOTICE AND DISCLAIMER

TI PROVIDES TECHNICAL AND RELIABILITY DATA (INCLUDING DATA SHEETS), DESIGN RESOURCES (INCLUDING REFERENCE DESIGNS), APPLICATION OR OTHER DESIGN ADVICE, WEB TOOLS, SAFETY INFORMATION, AND OTHER RESOURCES "AS IS" AND WITH ALL FAULTS, AND DISCLAIMS ALL WARRANTIES, EXPRESS AND IMPLIED, INCLUDING WITHOUT LIMITATION ANY IMPLIED WARRANTIES OF MERCHANTABILITY, FITNESS FOR A PARTICULAR PURPOSE OR NON-INFRINGEMENT OF THIRD PARTY INTELLECTUAL PROPERTY RIGHTS.

These resources are intended for skilled developers designing with TI products. You are solely responsible for (1) selecting the appropriate TI products for your application, (2) designing, validating and testing your application, and (3) ensuring your application meets applicable standards, and any other safety, security, regulatory or other requirements.

These resources are subject to change without notice. TI grants you permission to use these resources only for development of an application that uses the TI products described in the resource. Other reproduction and display of these resources is prohibited. No license is granted to any other TI intellectual property right or to any third party intellectual property right. TI disclaims responsibility for, and you will fully indemnify TI and its representatives against, any claims, damages, costs, losses, and liabilities arising out of your use of these resources.

TI's products are provided subject to [TI's Terms of Sale](#) or other applicable terms available either on [ti.com](https://www.ti.com) or provided in conjunction with such TI products. TI's provision of these resources does not expand or otherwise alter TI's applicable warranties or warranty disclaimers for TI products.

TI objects to and rejects any additional or different terms you may have proposed.

Mailing Address: Texas Instruments, Post Office Box 655303, Dallas, Texas 75265
Copyright © 2024, Texas Instruments Incorporated