

TLV773 300mA, Small-Size, High-PSRR, Low-Dropout Regulator

1 Features

- High PSRR: Up to 80dB
 - 72dB (1kHz)
 - 55dB (1MHz)
- V_{IN} range: 1.4V to 5.5V
- Fixed output voltage range: 0.6V to 3.3V
- Output voltage accuracy: 2%
- Low dropout voltage:
 - 180mV at 300mA ($3.3V_{OUT}$, DQN package)
- Foldback current limit
- Active output pulldown resistor
- Packages:
 - 1mm × 1mm, 4-pin X2SON (DQN)
 - 5-pin SOT-23 (DBV)

2 Applications

- [Smartphones](#)
- [Tablets](#)
- [Gaming consoles](#)
- [Notebooks](#)
- [Streaming media players](#)
- [Set-top boxes](#)
- [Camera modules](#)

3 Description

The TLV773 is a small, low-dropout (LDO) linear regulator that sources 300mA of output current. This LDO provides a voltage source with high PSRR and load and line transient performance that meets the requirements for a variety of circuits. The TLV773 has a 1.4V to 5.5V input voltage range and a 0.6V to 3.3V output voltage range. This flexibility makes the device useful for multiple applications.

The TLV773 features an internal soft-start circuit to avoid excessive inrush current, thus minimizing the input voltage drop during start-up. An active pulldown circuit quickly discharges the output when the LDO is disabled and provides a known start-up state. The EN input allows an external logic signal to enable or disable the regulated output. The LDO is stable with small ceramic capacitors, allowing for a small overall package size. The operating junction temperature range is from -40°C to $+125^{\circ}\text{C}$. This LDO is available in standard SOT-23 (DBV) and 1mm × 1mm X2SON (DQN) packages.

Package Information

PART NUMBER	PACKAGE ⁽¹⁾	PACKAGE SIZE ⁽²⁾
TLV773	DQN (X2SON, 4)	1mm × 1mm
	DBV (SOT-23, 5)	2.9mm × 2.8mm

(1) For more information, see the [Mechanical, Packaging, and Orderable Information](#).

(2) The package size (length × width) is a nominal value and includes pins, where applicable.

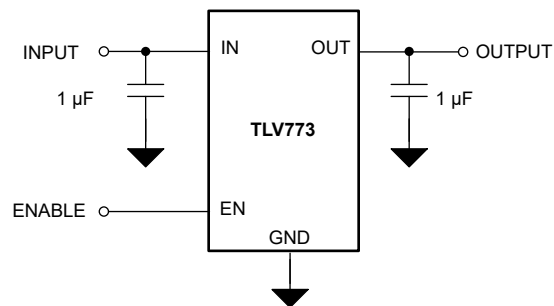

Typical Application Circuit



Table of Contents

1 Features	1	7 Application and Implementation	14
2 Applications	1	7.1 Application Information.....	14
3 Description	1	7.2 Typical Application.....	15
4 Pin Configuration and Functions	3	7.3 Power Supply Recommendations.....	16
5 Specifications	4	7.4 Layout.....	17
5.1 Absolute Maximum Ratings.....	4	8 Device and Documentation Support	18
5.2 ESD Ratings.....	4	8.1 Device Support.....	18
5.3 Recommended Operating Conditions.....	4	8.2 Documentation Support.....	18
5.4 Thermal Information.....	5	8.3 Receiving Notification of Documentation Updates....	18
5.5 Electrical Characteristics.....	5	8.4 Support Resources.....	18
5.6 Switching Characteristics.....	6	8.5 Trademarks.....	18
5.7 Typical Characteristics.....	7	8.6 Electrostatic Discharge Caution.....	18
6 Detailed Description	10	8.7 Glossary.....	18
6.1 Overview.....	10	9 Revision History	19
6.2 Functional Block Diagram.....	10	10 Mechanical, Packaging, and Orderable Information	19
6.3 Feature Description.....	10		
6.4 Device Functional Modes.....	13		

4 Pin Configuration and Functions

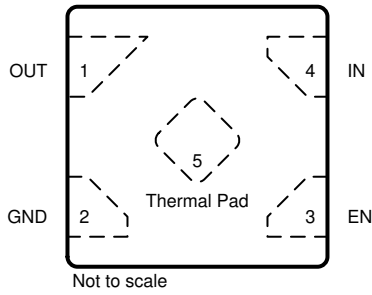

Figure 4-1. DQN Package, 1mm × 1mm, 4-Pin X2SON (Top View)

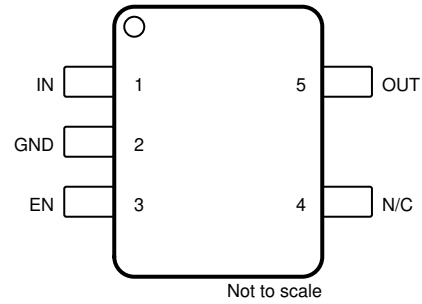

Figure 4-2. DBV Package, 5-Pin SOT-23 (Top View)

Table 4-1. Pin Functions

NAME	PIN		TYPE ⁽¹⁾	DESCRIPTION
	X2SON	SOT-23		
EN	3	3	I	Enable input. A low voltage ($< V_{EN(Low)}$) on this pin turns the regulator off and discharges the output pin to GND. A high voltage ($> V_{EN(Hi)}$) on this pin enables the regulator output.
GND	2	2	G	Common ground.
IN	4	1	I	Input voltage supply. For best transient response and to minimize input impedance, use the nominal value or larger capacitor from IN to ground, as listed in the <i>Recommended Operating Conditions</i> table. Place the input capacitor as close to the IN and GND pins of the device as possible.
N/C	—	4	—	No internal electrical connection. Connect to GND for improved thermal performance.
OUT	1	5	O	Regulated output voltage. A low equivalent series resistance (ESR) capacitor is required from OUT to ground for stability. For best transient response, use the nominal recommended value or larger capacitor listed in the <i>Recommended Operating Conditions</i> table. Place the output capacitor as close to the OUT and GND pins of the device as possible. An internal pulldown resistor prevents a charge from remaining on V_{OUT} when the regulator is in shutdown mode ($V_{EN} < V_{EN(Low)}$).
Thermal Pad	5	—	—	Thermal pad for the X2SON package. Connect this pad to GND or leave floating. Do not connect to any potential other than GND. Connect the thermal pad to a large-area ground plane for best thermal performance.

(1) I = input, O = output, I/O = input or output, and G = ground.

5 Specifications

5.1 Absolute Maximum Ratings

over operating free-air temperature range (unless otherwise noted)^{(1) (3)}

		MIN	MAX	UNIT
Voltage	Input, V_{IN}	-0.3	6.5	V
	Output, V_{OUT}	-0.3	6.0 or $V_{IN} + 0.3$ ⁽²⁾	
	Enable, V_{EN}	-0.3	6.5	
Current	Maximum output, I_{OUT} ⁽⁴⁾	Internally limited		A
Temperature	Operating junction, T_J	-55	150	°C
	Storage, T_{stg}	-65	150	

- (1) Operation outside the *Absolute Maximum Ratings* may cause permanent device damage. *Absolute Maximum Ratings* do not imply functional operation of the device at these or any other conditions beyond those listed under *Recommended Operating Conditions*. If used outside the *Recommended Operating Conditions* but within the *Absolute Maximum Ratings*, the device may not be fully functional, and this may affect device reliability, functionality, performance, and shorten the device lifetime.
- (2) The maximum value of V_{OUT} is the lesser of 6.0V or ($V_{IN} + 0.3V$).
- (3) All voltages are with respect to the GND pin.
- (4) Internal thermal shutdown circuitry protects the device from permanent damage.

5.2 ESD Ratings

			VALUE	UNIT
$V_{(ESD)}$	Electrostatic discharge	Human-body model (HBM), per ANSI/ESDA/JEDEC JS-001 ⁽¹⁾	±1000	V
		Charged-device model (CDM), per JEDEC specification JESD22-C101 ⁽²⁾	±500	

- (1) JEDEC document JEP155 states that 500V HBM allows safe manufacturing with a standard ESD control process.
- (2) JEDEC document JEP157 states that 250V CDM allows safe manufacturing with a standard ESD control process.

5.3 Recommended Operating Conditions

over operating free-air temperature range (unless otherwise noted)⁽¹⁾

		MIN	NOM	MAX	UNIT
V_{IN}	Input supply voltage	1.4		5.5	V
V_{EN}	Enable input voltage	0		5.5	V
V_{OUT}	Nominal output voltage range	0.6		3.3	V
I_{OUT}	Output current	0		300	mA
C_{IN}	Input capacitor ⁽²⁾		1		μF
C_{OUT}	Output capacitance ⁽³⁾	0.47		40	μF
ESR	Output capacitor effective series resistance			100	mΩ
T_J	Operating junction temperature	-40		125	°C

- (1) All voltages are with respect to GND.
- (2) An input capacitor is not required for LDO stability. However, an input capacitor with an effective value of 0.47 μF minimum is recommended to counteract the effect of source resistance and inductance, which in some cases causes symptoms of system-level instability such as ringing or oscillation, especially in the presence of load transients. Depending on the characteristics of the input voltage source, use a larger input capacitance if needed.
- (3) Effective output capacitance of 0.47 μF minimum and 40 μF maximum is required for stability. The effective output capacitance accounts for tolerance, temperature, voltage, and any other factors that affect the value, and is often 50% smaller than the capacitors specified value.

5.4 Thermal Information

THERMAL METRIC ⁽¹⁾		TLV773		UNIT
		DBV (SOT-23)	DQN (X2SON)	
		5 PINS	4 PINS	
R _{θJA}	Junction-to-ambient thermal resistance	242.5	236.2	°C/W
R _{θJC(top)}	Junction-to-case (top) thermal resistance	140.9	218.5	°C/W
R _{θJB}	Junction-to-board thermal resistance	109.4	180.8	°C/W
ψ _{JT}	Junction-to-top characterization parameter	76.1	16.1	°C/W
ψ _{JB}	Junction-to-board characterization parameter	108.8	179.6	°C/W
R _{θJC(bot)}	Junction-to-case (bottom) thermal resistance	N/A	157.2	°C/W

(1) For more information about traditional and new thermal metrics, see the [Semiconductor and IC Package Thermal Metrics](#) application note.

5.5 Electrical Characteristics

at operating temperature T_J = 25°C, V_{IN} = V_{OUT(NOM)} + 0.5V or 1.4V, whichever is greater, V_{EN} = V_{IN}, I_{OUT} = 1mA, C_{IN} = 1μF, and C_{OUT} = 1μF (unless otherwise noted); all typical values are at T_J = 25°C

PARAMETER		TEST CONDITIONS		MIN	TYP	MAX	UNIT				
ΔV _{OUT}	Output voltage tolerance	T _J = -40°C to 85°C	0.6V ≤ V _{OUT} < 1.8V	-2.5		2.5	%				
			1.8V ≤ V _{OUT} ≤ 3.3V	-2		2					
			0.6V ≤ V _{OUT} < 1.2V	-3.33		3.33					
			1.2V ≤ V _{OUT} < 1.8V	-3		3					
			1.8V ≤ V _{OUT} < 2.5V	-2.75		2.75					
			2.5V ≤ V _{OUT} ≤ 3.3V	-2.5		2.5					
ΔV _{OUT} / ΔV _{IN}	Line regulation	V _{IN} = (V _{OUT(NOM)} + 0.5V) to 5.5V			0.01	0.1	%/V				
ΔV _{OUT} / ΔI _{OUT}	Load regulation	I _{OUT} = 1mA to 300mA			85	110	μV/mA				
I _{GND}	Quiescent ground current	V _{EN} = V _{IN} = 5.5V, I _{OUT} = 0mA, T _J = -40°C to 85°C			80	120	μA				
I _{SHDN}	Shutdown ground current	V _{EN} < V _{EN(LOW)} , V _{IN} = 5.5V, T _J = -40°C to 85°C			0.01	2	μA				
V _{DO}	Dropout voltage	I _{OUT} = 300mA, V _{IN} = 95% x V _{OUT(NOM)}	1.2V ≤ V _{OUT} < 1.8V ^{(1) (2)}			600	mV				
			1.8V ≤ V _{OUT} < 2.5V			330					
			2.5V ≤ V _{OUT} < 2.8V			245					
			1.2V ≤ V _{OUT} < 1.8V ^{(1) (2)}			680					
			1.8V ≤ V _{OUT} < 2.5V			385					
			2.5V ≤ V _{OUT} < 2.8V			285					
		I _{OUT} = 300mA, V _{IN} = 95% x V _{OUT(NOM)}	2.8V ≤ V _{OUT} ≤ 3.3V, DBV package		200			220			
			2.8V ≤ V _{OUT} ≤ 3.3V, DQN package		180			200			
			2.8V ≤ V _{OUT} ≤ 3.3V, DBV package					255			
			2.8V ≤ V _{OUT} ≤ 3.3V, DQN package					230			
			I _{CL}	Output current limit	V _{OUT} = 0.9 x V _{OUT(NOM)} , T _J = -40°C to 85°C			350		720	mA
			I _{SC}	Short-circuit current limit	V _{OUT} = 0V				65		mA
PSRR	Power-supply rejection ratio	I _{OUT} = 1mA, V _{IN} = V _{OUT} + 1.0V	f = 217Hz		80	dB					
			f = 1kHz		72						
		I _{OUT} = 50mA, V _{IN} = V _{OUT} + 1.0V	f = 100kHz		56						
			f = 1MHz		55						
V _N	Output noise voltage	BW = 10Hz to 100kHz, I _{OUT} = 50mA			75 x V _{OUT}		μV _{RMS}				
R _{PULLDOWN}	Output automatic discharge pulldown resistance	V _{EN} < V _{EN(LOW)} (output disabled), V _{IN} = 3.3V			135		Ω				

5.5 Electrical Characteristics (continued)

at operating temperature $T_J = 25^\circ\text{C}$, $V_{IN} = V_{OUT(NOM)} + 0.5\text{V}$ or 1.4V , whichever is greater, $V_{EN} = V_{IN}$, $I_{OUT} = 1\text{mA}$, $C_{IN} = 1\mu\text{F}$, and $C_{OUT} = 1\mu\text{F}$ (unless otherwise noted); all typical values are at $T_J = 25^\circ\text{C}$

PARAMETER		TEST CONDITIONS	MIN	TYP	MAX	UNIT
T_{SD}	Thermal shutdown	T_J rising		160		$^\circ\text{C}$
		T_J falling		140		
$V_{EN(LOW)}$	Low input threshold	V_{EN} falling until the output is disabled. $T_J = -40^\circ\text{C}$ to 85°C			0.3	V
$V_{EN(HI)}$	High input threshold	V_{EN} rising until the output is enabled. $T_J = -40^\circ\text{C}$ to 85°C	0.9			V
I_{EN}	EN input leakage current	$V_{EN} = 5.5\text{V}$ and $V_{IN} = 5.5\text{V}$		0.01	1	μA

- (1) For $V_{OUT} < 1.5\text{V}$, dropout is tested with $V_{IN} = 1.4\text{V}$.
 (2) For $V_{OUT} = 0.6\text{V}$, Dropout voltage < Headroom voltage. At $V_{IN} = 1.4\text{V}$, a 0.6V output device will not be in dropout. Headroom voltage = $V_{IN} - V_{OUT}$.

5.6 Switching Characteristics

specifications apply for $T_J = 25^\circ\text{C}$, $V_{IN} = V_{OUT(NOM)} + 0.5\text{V}$ or 1.4V , whichever is greater, $V_{EN} = V_{IN}$, $I_{OUT} = 1\text{mA}$, $C_{IN} = 1\mu\text{F}$, and $C_{OUT} = 1\mu\text{F}$ (unless otherwise noted); all typical values are at $T_J = 25^\circ\text{C}$

PARAMETER		TEST CONDITIONS	MIN	TYP	MAX	UNIT
t_{STR}	Start-up time (V_{EN})	From $V_{EN} > V_{EN(HI)}$ to $V_{OUT} = 95\%$ of $V_{OUT(NOM)}$, V_{IN} rise time = $1\text{V}/\mu\text{s}$		400		μs

5.7 Typical Characteristics

at operating temperature $T_J = 25^\circ\text{C}$, $V_{IN} = V_{OUT(NOM)} + 0.5\text{V}$, $I_{OUT} = 1\text{mA}$, $V_{EN} = V_{IN}$, and $C_{IN} = C_{OUT} = 1\mu\text{F}$ (unless otherwise noted)

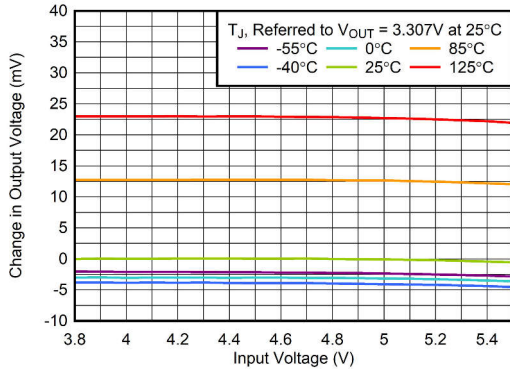

Figure 5-1. Line Regulation vs V_{IN}

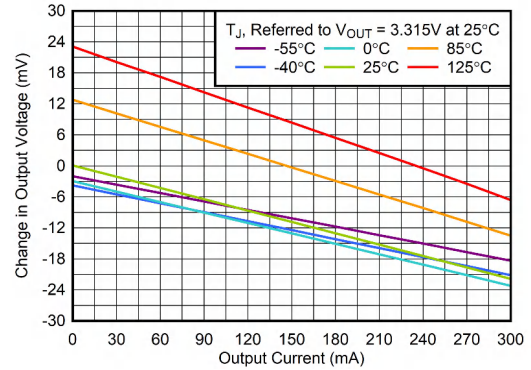

Figure 5-2. Load Regulation vs I_{OUT}

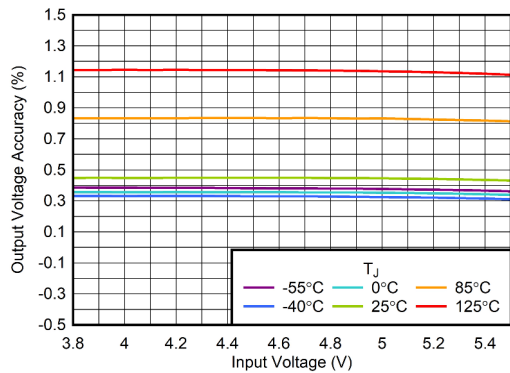

Figure 5-3. Output Voltage Accuracy vs V_{IN}

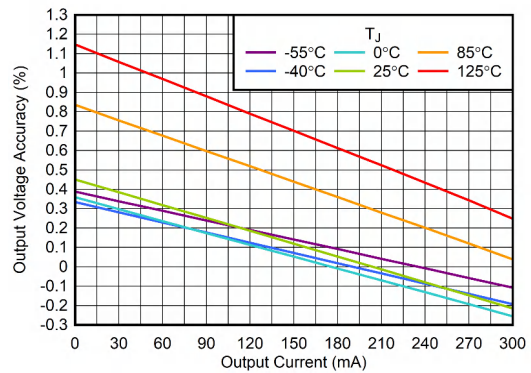

Figure 5-4. Output Voltage Accuracy vs I_{OUT}

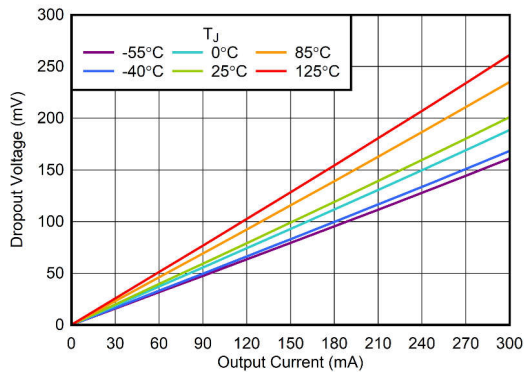

Figure 5-5. Dropout Voltage vs I_{OUT}

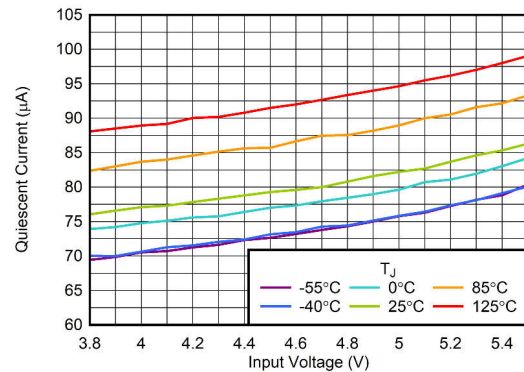
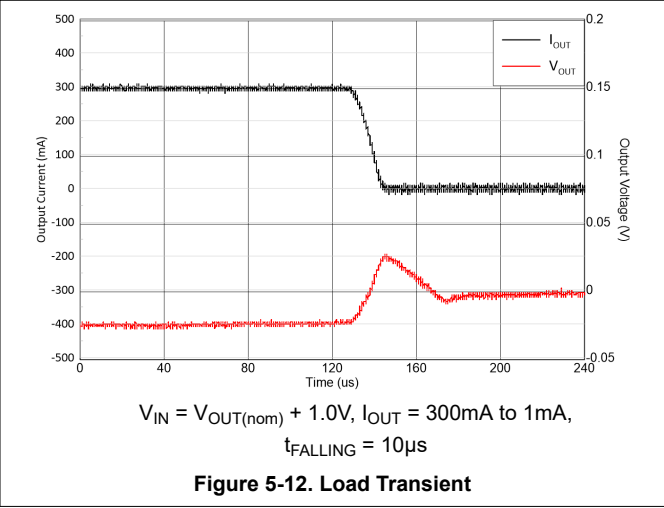
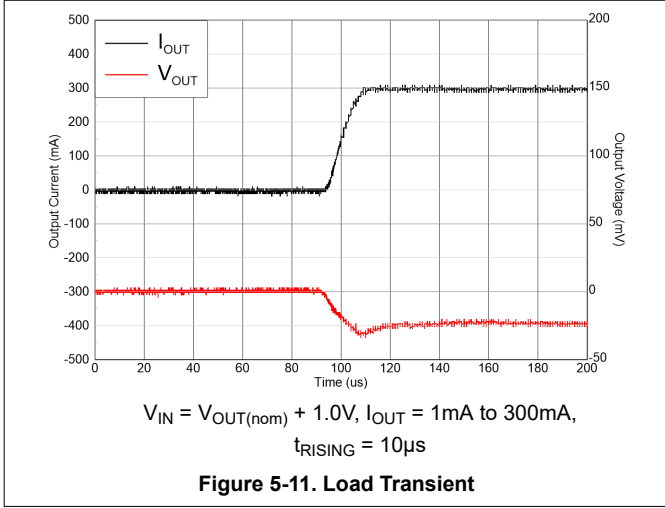
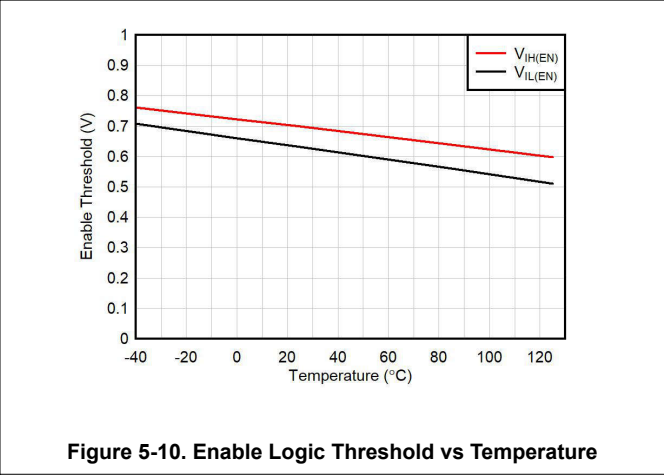
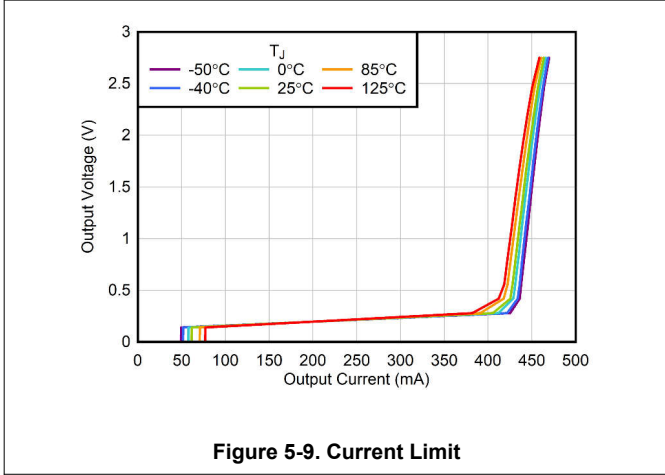
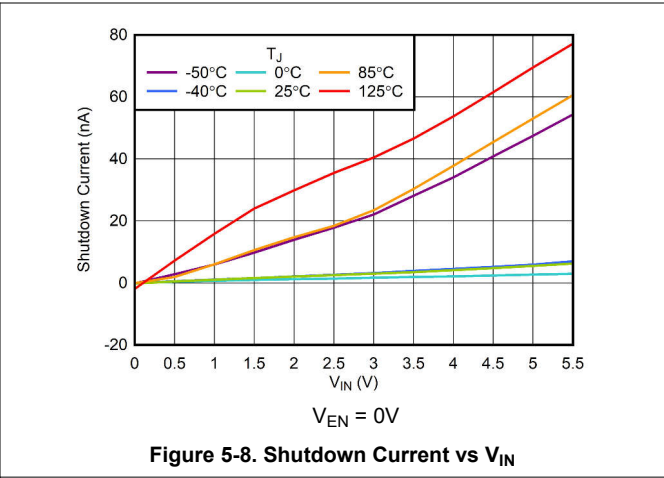
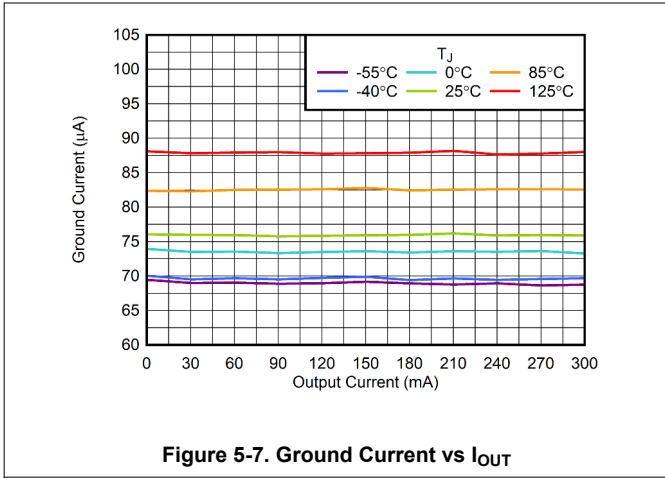

Figure 5-6. Quiescent Current vs V_{IN}

5.7 Typical Characteristics (continued)

at operating temperature $T_J = 25^\circ\text{C}$, $V_{IN} = V_{OUT(NOM)} + 0.5\text{V}$, $I_{OUT} = 1\text{mA}$, $V_{EN} = V_{IN}$, and $C_{IN} = C_{OUT} = 1\mu\text{F}$ (unless otherwise noted)



5.7 Typical Characteristics (continued)

at operating temperature $T_J = 25^\circ\text{C}$, $V_{IN} = V_{OUT(NOM)} + 0.5\text{V}$, $I_{OUT} = 1\text{mA}$, $V_{EN} = V_{IN}$, and $C_{IN} = C_{OUT} = 1\mu\text{F}$ (unless otherwise noted)

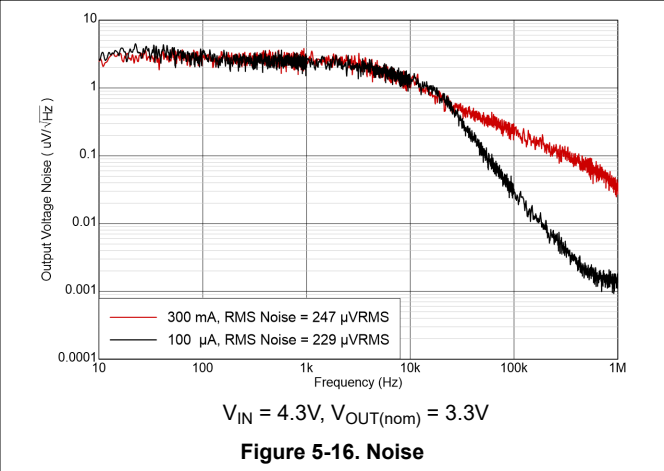
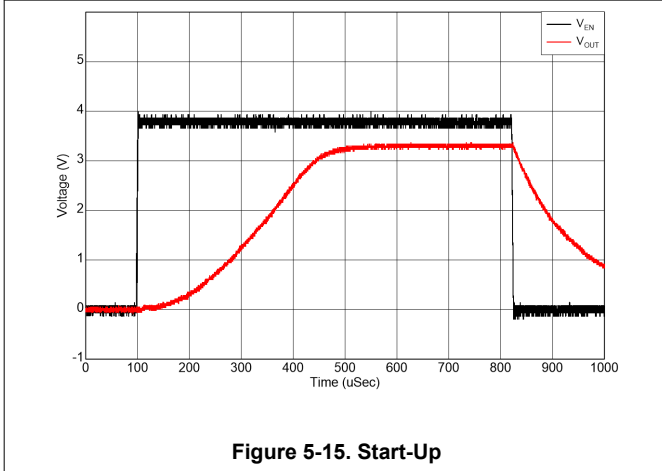
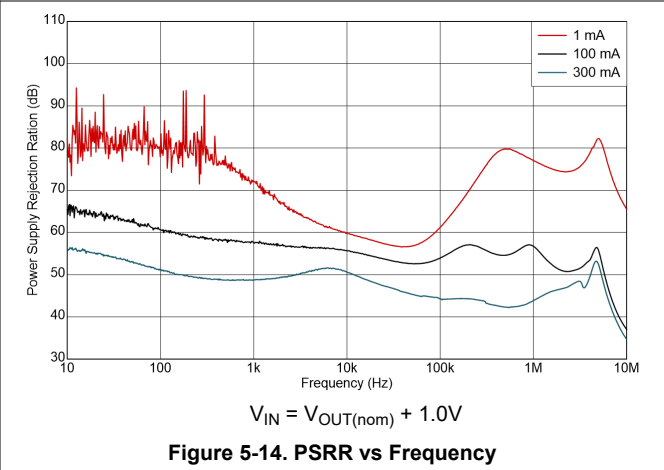
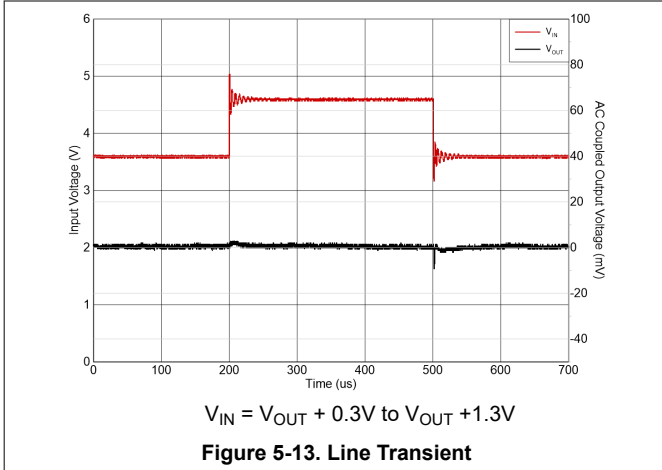

6 Detailed Description

6.1 Overview

The TLV773 provides high PSRR and good transient response in a small, 300mA LDO.

This LDO is designed to operate with a single 1 μ F input capacitor and a single 1 μ F ceramic output capacitor.

6.2 Functional Block Diagram

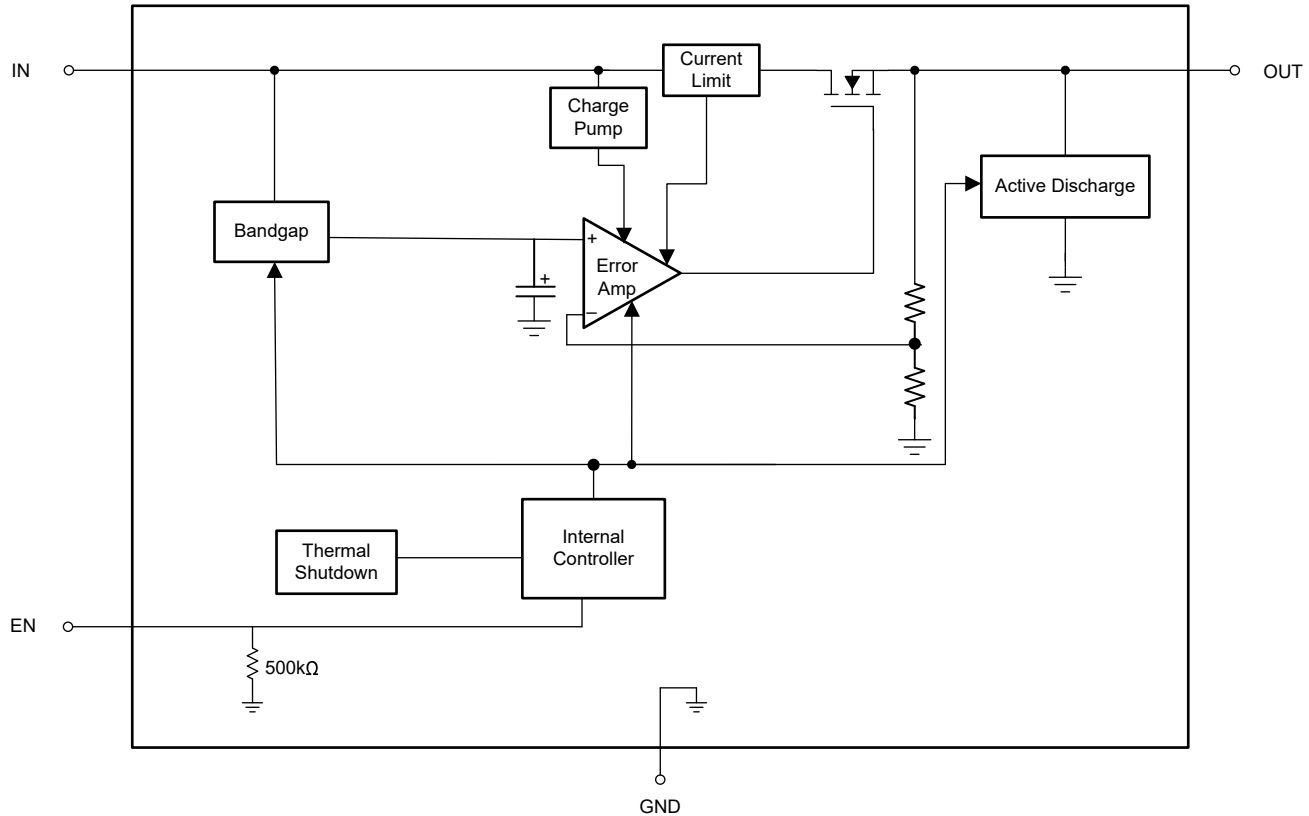

6.3 Feature Description

6.3.1 Dropout Voltage

Dropout voltage (V_{DO}) is defined as $V_{IN} - V_{OUT}$ at the rated output current (I_{RATED}), where the pass transistor is fully on. V_{IN} is the input voltage, V_{OUT} is the output voltage, and I_{RATED} is the maximum I_{OUT} listed in the *Recommended Operating Conditions* table. At this operating point, the pass transistor is driven fully on. Dropout voltage indirectly specifies a minimum input voltage greater than the nominal programmed output voltage where the output voltage is expected to stay in regulation. If the input voltage falls to less than the nominal output regulation, then the output voltage falls as well.

For a CMOS regulator, the dropout voltage is determined by the drain-source, on-state resistance ($R_{DS(ON)}$) of the pass transistor. Therefore, if the linear regulator operates at less than the rated current, the dropout voltage for that current scales accordingly. The following equation calculates the $R_{DS(ON)}$ of the device.

$$R_{DS(ON)} = \frac{V_{DO}}{I_{RATED}} \quad (1)$$

6.3.2 Active Discharge

The regulator has an internal MOSFET that connects a pulldown resistor between the output and ground when the device is disabled. This connection actively discharges the output voltage. The active discharge circuit is activated by the enable pin or by the voltage on IN falling below the undervoltage lockout (UVLO) threshold.

Do not rely on the active discharge circuit for discharging a large amount of output capacitance after the input supply collapses. Reverse current flow from the output to the input potentially causes damage to the device. Limit reverse current to no more than 5% of the device rated current for a short period of time.

6.3.3 Foldback Current Limit

The device has an internal current limit circuit that protects the regulator during transient high-load current faults or shorting events. The current limit is a hybrid brick-wall-foldback scheme. The current limit transitions from a brick-wall scheme to a foldback scheme at the foldback voltage ($V_{FOLDBACK}$). In a high-load current fault with the output voltage above $V_{FOLDBACK}$, the brick-wall scheme limits the output current to the current limit (I_{CL}). When the voltage drops below $V_{FOLDBACK}$, a foldback current limit activates that scales back the current when the output voltage approaches GND. When the output is shorted, the device supplies a typical current termed the *short-circuit current limit* (I_{SC}). I_{CL} and I_{SC} are listed in the [Electrical Characteristics](#) table.

The output voltage is not regulated when the device is in current limit. When a current limit event occurs, the device begins to heat up because of the increase in power dissipation. When the device is in brick-wall current limit, the pass transistor dissipates power $[(V_{IN} - V_{OUT}) \times I_{CL}]$. When the device output is shorted and the output is below $V_{FOLDBACK}$, the pass transistor dissipates power $[(V_{IN} - V_{OUT}) \times I_{SC}]$. If thermal shutdown is triggered, the device turns off. After the device cools down, the internal thermal shutdown circuit turns the device back on. If the output current fault condition continues, the device cycles between current limit and thermal shutdown. For more information on current limits, see the [Know Your Limits application note](#).

Figure 6-1 shows a diagram of the foldback current limit.

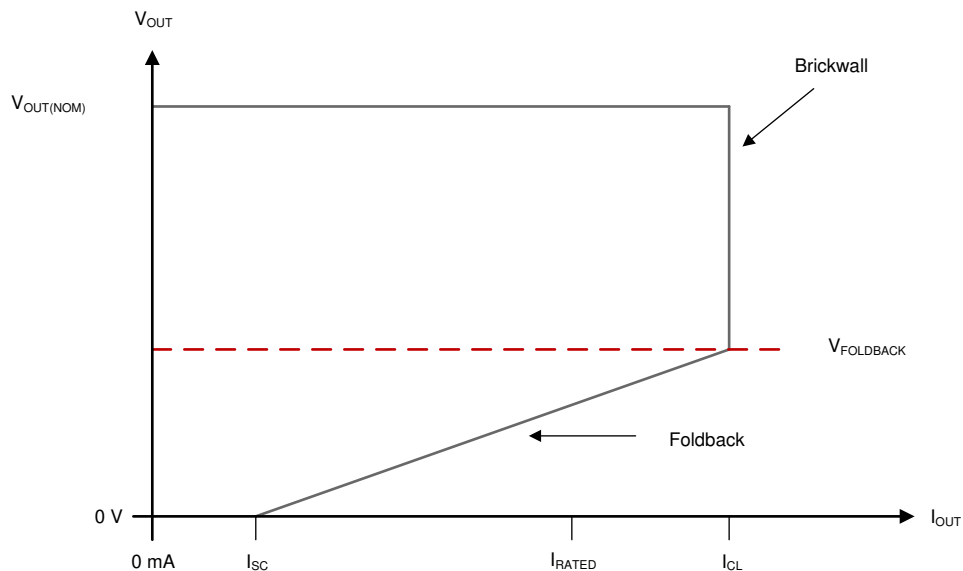

Figure 6-1. Foldback Current Limit

6.3.4 Thermal Shutdown

The device contains a thermal shutdown protection circuit to disable the device when the junction temperature (T_J) of the pass transistor rises to $T_{SD(\text{shutdown})}$ (typical). Thermal shutdown hysteresis makes sure that the device resets (turns on) when the temperature falls to $T_{SD(\text{reset})}$ (typical).

The thermal time-constant of the semiconductor die is fairly short. Thus the device cycles on and off when thermal shutdown is reached until power dissipation is reduced. Power dissipation during start-up is high from large $V_{IN} - V_{OUT}$ voltage drops across the device or from high inrush currents charging large output capacitors. Under some conditions, the thermal shutdown protection disables the device before start-up completes.

For reliable operation, limit the junction temperature to the maximum listed in the [Recommended Operating Conditions](#) table. Operation above this maximum temperature causes the device to exceed operational specifications. Although the device internal protection circuitry is designed to protect against thermal overload conditions, this circuitry is not intended to replace proper heat sinking. Continuously running the device into thermal shutdown or above the maximum recommended junction temperature reduces long-term reliability.

6.4 Device Functional Modes

Table 6-1 shows the conditions that lead to the different modes of operation. See the [Electrical Characteristics](#) table for parameter values.

Table 6-1. Device Functional Mode Comparison

OPERATING MODE	PARAMETER			
	V_{IN}	V_{EN}	I_{OUT}	T_J
Normal operation	$V_{IN} > V_{OUT(nom)} + V_{DO}$ and $V_{IN} > V_{IN(min)}$	$V_{EN} > V_{EN(HI)}$	$I_{OUT} < I_{OUT(max)}$	$T_J < T_{SD(shutdown)}$
Dropout operation	$V_{IN(min)} < V_{IN} < V_{OUT(nom)} + V_{DO}$	$V_{EN} > V_{EN(HI)}$	$I_{OUT} < I_{OUT(max)}$	$T_J < T_{SD(shutdown)}$
Disabled (any true condition disables the device)	$V_{IN} < V_{UVLO}$	$V_{EN} < V_{EN(LOW)}$	Not applicable	$T_J > T_{SD(shutdown)}$

6.4.1 Normal Operation

The device regulates to the nominal output voltage when the following conditions are met:

- The input voltage is greater than the nominal output voltage plus the dropout voltage ($V_{OUT(nom)} + V_{DO}$)
- The output current is less than the current limit ($I_{OUT} < I_{CL}$)
- The device junction temperature is less than the thermal shutdown temperature ($T_J < T_{SD}$)
- The enable voltage has previously exceeded the enable rising threshold voltage and has not yet decreased to less than the enable falling threshold

6.4.2 Dropout Operation

If the input voltage is lower than the nominal output voltage plus the specified dropout voltage, the device operates in dropout mode. In this mode, the output voltage tracks the input voltage. In this mode, the transient performance of the device becomes significantly degraded. During this mode, the pass transistor is driven fully on. Line or load transients in dropout potentially result in large output voltage deviations.

When the device is in a steady dropout state, the pass transistor is driven fully on. This state is defined as when the device is in dropout, directly after being in a normal regulation state, but *not* during start-up. Dropout occurs when $V_{IN} < V_{OUT(NOM)} + V_{DO}$. When the regulator exits dropout, the input voltage returns to a value $\geq V_{OUT(NOM)} + V_{DO}$. During this time, the output voltage potentially overshoots for a short period of time. $V_{OUT(NOM)}$ is the nominal output voltage and V_{DO} is the dropout voltage. During dropout exit, the device pulls the pass transistor back from being driven fully on.

6.4.3 Disabled

Shutdown the device output by forcing the enable pin voltage to less than the maximum EN pin low-level input voltage (see the [Electrical Characteristics](#) table). When disabled, the pass transistor turns off and internal circuits shut down. The output voltage is also actively discharged to ground by an internal discharge circuit from the output to ground.

7 Application and Implementation

Note

Information in the following applications sections is not part of the TI component specification, and TI does not warrant its accuracy or completeness. TI's customers are responsible for determining suitability of components for their purposes, as well as validating and testing their design implementation to confirm system functionality.

7.1 Application Information

7.1.1 Recommended Capacitor Types

The device is designed to be stable using low equivalent series resistance (ESR) ceramic capacitors at the input and output. Multilayer ceramic capacitors have become the industry standard for these types of applications and are recommended, but use good judgment. Ceramic capacitors that employ X7R-, X5R-, and C0G-rated dielectric materials provide relatively good capacitive stability across temperature. However, using Y5V-rated capacitors is discouraged because of large variations in capacitance.

Regardless of the ceramic capacitor type selected, the effective capacitance varies with operating voltage and temperature. Generally, expect the effective capacitance to decrease by as much as 50%. The input and output capacitors listed in the [Recommended Operating Conditions](#) table account for an effective capacitance of approximately 50% of the nominal value.

7.1.2 Input and Output Capacitor Requirements

Although an input capacitor is not required for stability, good analog design practice is to connect a capacitor from IN to GND. This capacitor counteracts reactive input sources and improves transient response, input ripple, and PSRR. Use an input capacitor if the source impedance is more than 0.5Ω. For typical operation of the TLV773, connect a 1μF capacitor to the input. Use a higher value capacitor if large, fast rise-time, load, or line transients are anticipated. Additionally, use a higher-value capacitor if the device is located several inches from the input power source.

Dynamic performance of the device is improved by using an output capacitor. Use an output capacitor within the range specified in the [Recommended Operating Conditions](#) table for stability. Make sure that the minimum derated output capacitance is equal to or greater than 0.47μF. When the output voltage is ramping up, the inrush current depends on the size of the output capacitance. During start-up, the output current is potentially as high as the current limit value for larger output capacitors.

7.2 Typical Application

7.2.1 Application

Figure 7-1 shows a typical application circuit for the TLV773.

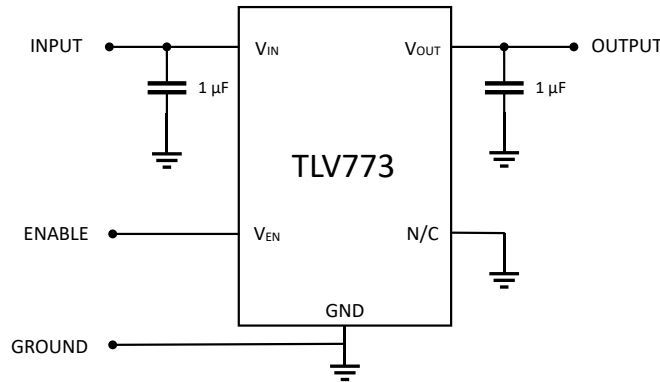

Figure 7-1. TLV773 Typical Application

7.2.2 Design Requirements

Table 7-1 summarizes the design requirements for Figure 7-1.

Table 7-1. Design Parameters

PARAMETER	VALUE
Input voltage range	4.0V ± 5%
Output voltage	3.3V
Output current	200mA
Maximum ambient temperature	85°C

7.2.3 Detailed Design Procedure

For this design example, the 3.3V output version (TLV77333) is selected. A nominal 4.0V input supply is assumed. Use a minimum 1µF input capacitor to minimize the effect of resistance and inductance between the 4.0V source and the LDO input. Use a minimum 0.47µF output capacitance for stability and good load transient response. The dropout voltage (V_{DO}) is less than 250mV maximum at a 3.3V output voltage and 300mA output current. Thus, there are no dropout issues with a minimum input voltage of 3.8V (4.0V – 5%) and a maximum 200mA output current.

7.2.4 Application Curves

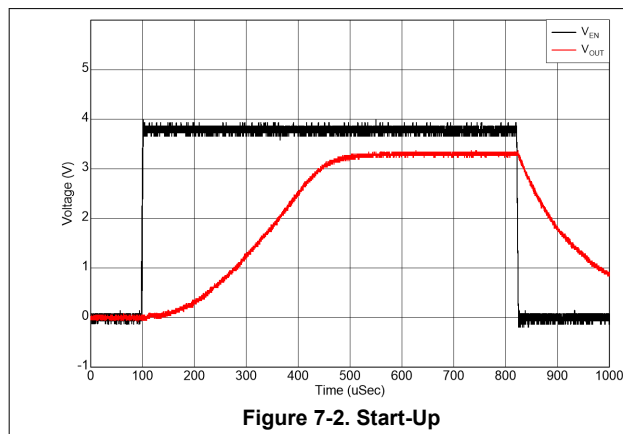

Figure 7-2. Start-Up

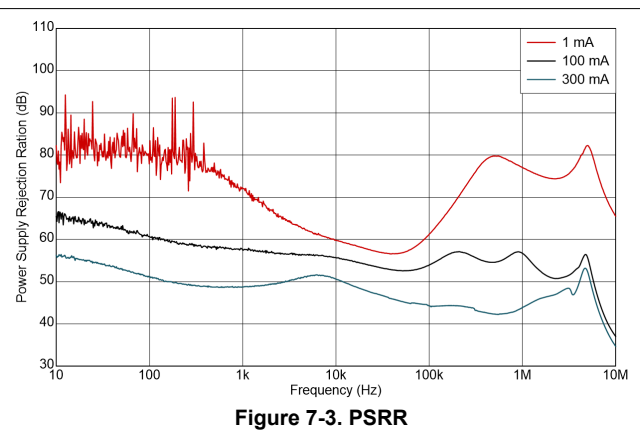

Figure 7-3. PSRR

7.3 Power Supply Recommendations

This device is designed to operate from an input supply voltage range of 1.4V to 5.5V. Make sure the input is well regulated and free of spurious noise, so the regulator provides a well regulated output with optimum dynamic performance. Set the input supply to at least $V_{OUT(nom)} + 0.5V$ or 1.4V, whichever is greater.

Use a 1 μ F or greater input capacitor to reduce the impedance of the input supply, especially during transients.

7.4 Layout

7.4.1 Layout Guidelines

- Place input and output capacitors as close to the device as possible.
- Use copper planes for device connections to optimize thermal performance.
- Place thermal vias around the device to distribute the heat.
- Do not place a thermal via directly beneath the thermal pad of the DQN package. A via wicks solder or solder paste away from the thermal pad joint during the soldering process. Thus, leading to a compromised solder joint on the thermal pad.

7.4.2 Layout Examples

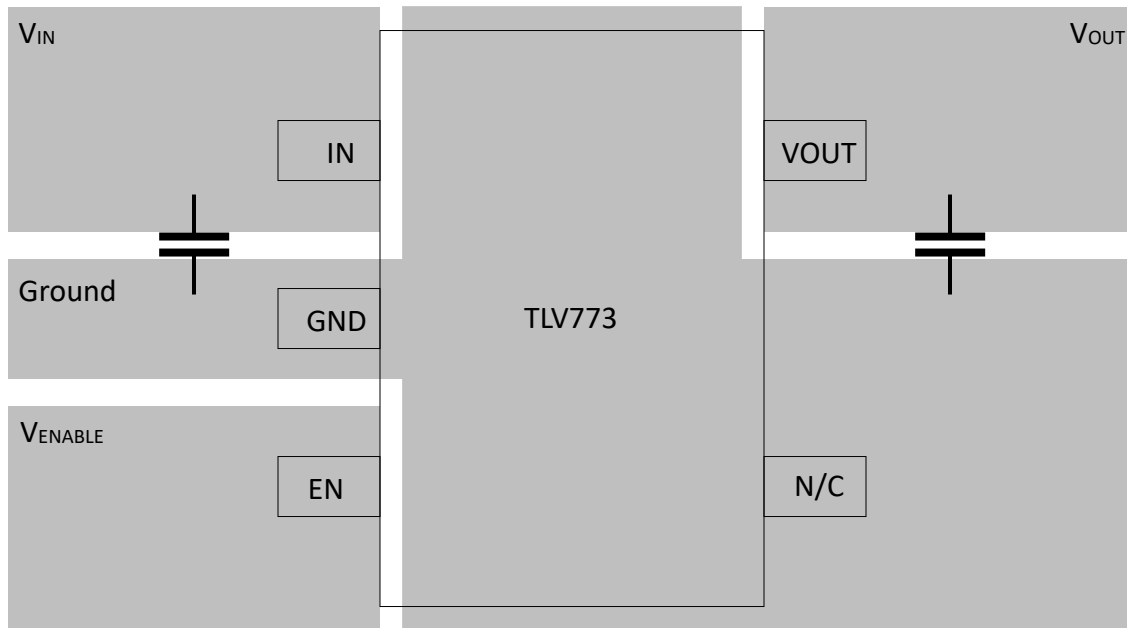

Figure 7-4. DBV Package (SOT-23) Typical Layout

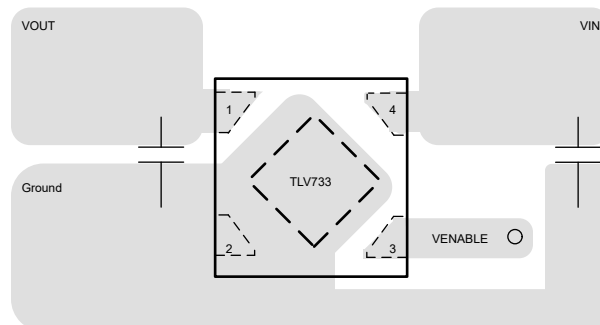

Figure 7-5. DQN Package (X2SON) Typical Layout

8 Device and Documentation Support

TI offers an extensive line of development tools. Tools and software to evaluate the performance of the device, generate code, and develop solutions are listed in this section.

8.1 Device Support

8.1.1 Device Nomenclature

Table 8-1. Device Nomenclature

PRODUCT ⁽¹⁾	DESCRIPTION
TLV773xx(x)Pyyyz	<p>xx(x) is the nominal output voltage. For output voltages with a resolution of 100mV, two digits are used in the ordering number; otherwise, three digits are used (for example, 28 = 2.8V; 125 = 1.25V).</p> <p>P indicates an active output discharge feature.</p> <p>yyy is the package designator.</p> <p>z is the package quantity. R is for reel (3000 pieces).</p>

(1) For the most current package and ordering information see the Package Option Addendum at the end of this document, or visit the device product folder on www.ti.com.

8.2 Documentation Support

8.2.1 Related Documentation

For related documentation, see the following:

- Texas Instruments, [Know Your Limits application note](#)

8.3 Receiving Notification of Documentation Updates

To receive notification of documentation updates, navigate to the device product folder on ti.com. Click on *Notifications* to register and receive a weekly digest of any product information that has changed. For change details, review the revision history included in any revised document.

8.4 Support Resources

[TI E2E™ support forums](#) are an engineer's go-to source for fast, verified answers and design help — straight from the experts. Search existing answers or ask your own question to get the quick design help you need.

Linked content is provided "AS IS" by the respective contributors. They do not constitute TI specifications and do not necessarily reflect TI's views; see TI's [Terms of Use](#).

8.5 Trademarks

TI E2E™ is a trademark of Texas Instruments.

All trademarks are the property of their respective owners.

8.6 Electrostatic Discharge Caution



This integrated circuit can be damaged by ESD. Texas Instruments recommends that all integrated circuits be handled with appropriate precautions. Failure to observe proper handling and installation procedures can cause damage.

ESD damage can range from subtle performance degradation to complete device failure. Precision integrated circuits may be more susceptible to damage because very small parametric changes could cause the device not to meet its published specifications.

8.7 Glossary

[TI Glossary](#) This glossary lists and explains terms, acronyms, and definitions.

9 Revision History

NOTE: Page numbers for previous revisions may differ from page numbers in the current version.

Changes from Revision A (April 2024) to Revision B (May 2024)	Page
• Changed <i>High PSRR</i> bullet in <i>Features</i>	1
• Changed operating junction temperature range from -40°C to $+85^{\circ}\text{C}$ to -40°C to $+125^{\circ}\text{C}$ throughout document.....	1
• Changed V_{IN} Absolute Maximum Rating.....	4
• Changed V_{EN} Absolute Maximum Rating.....	4
• Changed Operating junction temperature.....	4
• Added footnote explaining dropout and headroom.....	5
• Added PSRR at $f = 217\text{Hz}$ and 1kHz	5
• Changed I_{OUT} range from 0mA to 300mA to 1mA to 300mA in Load Transient curves of <i>Typical Characteristics</i>	7

Changes from Revision * (December 2023) to Revision A (April 2024)	Page
• Changed Output voltage tolerance.....	5
• Changed Quiescent ground current.....	5

10 Mechanical, Packaging, and Orderable Information

The following pages include mechanical, packaging, and orderable information. This information is the most current data available for the designated devices. This data is subject to change without notice and revision of this document. For browser-based versions of this data sheet, refer to the left-hand navigation.

PACKAGING INFORMATION

Orderable Device	Status (1)	Package Type	Package Drawing	Pins	Package Qty	Eco Plan (2)	Lead finish/ Ball material (6)	MSL Peak Temp (3)	Op Temp (°C)	Device Marking (4/5)	Samples
TLV77312PDBVR	ACTIVE	SOT-23	DBV	5	3000	RoHS & Green	SN	Level-1-260C-UNLIM	-40 to 85	3CQF	Samples
TLV77312PDQNR	ACTIVE	X2SON	DQN	4	3000	RoHS & Green	NIPDAU	Level-1-260C-UNLIM	-40 to 85	P5	Samples
TLV77318PDBVR	ACTIVE	SOT-23	DBV	5	3000	RoHS & Green	SN	Level-1-260C-UNLIM	-40 to 85	3CPF	Samples
TLV77318PDQNR	ACTIVE	X2SON	DQN	4	3000	RoHS & Green	NIPDAU	Level-1-260C-UNLIM	-40 to 85	P4	Samples
TLV77325PDBVR	ACTIVE	SOT-23	DBV	5	3000	RoHS & Green	SN	Level-1-260C-UNLIM	-40 to 85	3COF	Samples
TLV77325PDQNR	ACTIVE	X2SON	DQN	4	3000	RoHS & Green	NIPDAU	Level-1-260C-UNLIM	-40 to 85	P3	Samples
TLV77328PDBVR	ACTIVE	SOT-23	DBV	5	3000	RoHS & Green	SN	Level-1-260C-UNLIM	-40 to 85	3CNF	Samples
TLV77328PDQNR	ACTIVE	X2SON	DQN	4	3000	RoHS & Green	NIPDAU	Level-1-260C-UNLIM	-40 to 85	P2	Samples
TLV77333PDBVR	ACTIVE	SOT-23	DBV	5	3000	RoHS & Green	SN	Level-1-260C-UNLIM	-40 to 85	3CMF	Samples
TLV77333PDQNR	ACTIVE	X2SON	DQN	4	3000	RoHS & Green	NIPDAU	Level-1-260C-UNLIM	-40 to 85	P1	Samples

(1) The marketing status values are defined as follows:

ACTIVE: Product device recommended for new designs.

LIFEBUY: TI has announced that the device will be discontinued, and a lifetime-buy period is in effect.

NRND: Not recommended for new designs. Device is in production to support existing customers, but TI does not recommend using this part in a new design.

PREVIEW: Device has been announced but is not in production. Samples may or may not be available.

OBSOLETE: TI has discontinued the production of the device.

(2) **RoHS:** TI defines "RoHS" to mean semiconductor products that are compliant with the current EU RoHS requirements for all 10 RoHS substances, including the requirement that RoHS substance do not exceed 0.1% by weight in homogeneous materials. Where designed to be soldered at high temperatures, "RoHS" products are suitable for use in specified lead-free processes. TI may reference these types of products as "Pb-Free".

RoHS Exempt: TI defines "RoHS Exempt" to mean products that contain lead but are compliant with EU RoHS pursuant to a specific EU RoHS exemption.

Green: TI defines "Green" to mean the content of Chlorine (Cl) and Bromine (Br) based flame retardants meet JS709B low halogen requirements of <=1000ppm threshold. Antimony trioxide based flame retardants must also meet the <=1000ppm threshold requirement.

(3) MSL, Peak Temp. - The Moisture Sensitivity Level rating according to the JEDEC industry standard classifications, and peak solder temperature.

(4) There may be additional marking, which relates to the logo, the lot trace code information, or the environmental category on the device.

⁽⁵⁾ Multiple Device Markings will be inside parentheses. Only one Device Marking contained in parentheses and separated by a "~" will appear on a device. If a line is indented then it is a continuation of the previous line and the two combined represent the entire Device Marking for that device.

⁽⁶⁾ Lead finish/Ball material - Orderable Devices may have multiple material finish options. Finish options are separated by a vertical ruled line. Lead finish/Ball material values may wrap to two lines if the finish value exceeds the maximum column width.

Important Information and Disclaimer:The information provided on this page represents TI's knowledge and belief as of the date that it is provided. TI bases its knowledge and belief on information provided by third parties, and makes no representation or warranty as to the accuracy of such information. Efforts are underway to better integrate information from third parties. TI has taken and continues to take reasonable steps to provide representative and accurate information but may not have conducted destructive testing or chemical analysis on incoming materials and chemicals. TI and TI suppliers consider certain information to be proprietary, and thus CAS numbers and other limited information may not be available for release.

In no event shall TI's liability arising out of such information exceed the total purchase price of the TI part(s) at issue in this document sold by TI to Customer on an annual basis.

TAPE AND REEL INFORMATION

QUADRANT ASSIGNMENTS FOR PIN 1 ORIENTATION IN TAPE

*All dimensions are nominal

Device	Package Type	Package Drawing	Pins	SPQ	Reel Diameter (mm)	Reel Width W1 (mm)	A0 (mm)	B0 (mm)	K0 (mm)	P1 (mm)	W (mm)	Pin1 Quadrant
TLV77312PDBVR	SOT-23	DBV	5	3000	180.0	8.4	3.2	3.2	1.4	4.0	8.0	Q3
TLV77312PDQNR	X2SON	DQN	4	3000	180.0	8.4	1.16	1.16	0.5	4.0	8.0	Q2
TLV77318PDBVR	SOT-23	DBV	5	3000	180.0	8.4	3.2	3.2	1.4	4.0	8.0	Q3
TLV77318PDQNR	X2SON	DQN	4	3000	180.0	8.4	1.16	1.16	0.5	4.0	8.0	Q2
TLV77325PDBVR	SOT-23	DBV	5	3000	180.0	8.4	3.2	3.2	1.4	4.0	8.0	Q3
TLV77325PDQNR	X2SON	DQN	4	3000	180.0	8.4	1.16	1.16	0.5	4.0	8.0	Q2
TLV77328PDBVR	SOT-23	DBV	5	3000	180.0	8.4	3.2	3.2	1.4	4.0	8.0	Q3
TLV77328PDQNR	X2SON	DQN	4	3000	180.0	8.4	1.16	1.16	0.5	4.0	8.0	Q2
TLV77333PDBVR	SOT-23	DBV	5	3000	180.0	8.4	3.2	3.2	1.4	4.0	8.0	Q3
TLV77333PDQNR	X2SON	DQN	4	3000	180.0	8.4	1.16	1.16	0.5	4.0	8.0	Q2

TAPE AND REEL BOX DIMENSIONS

*All dimensions are nominal

Device	Package Type	Package Drawing	Pins	SPQ	Length (mm)	Width (mm)	Height (mm)
TLV77312PDBVR	SOT-23	DBV	5	3000	210.0	185.0	35.0
TLV77312PDQNR	X2SON	DQN	4	3000	210.0	185.0	35.0
TLV77318PDBVR	SOT-23	DBV	5	3000	210.0	185.0	35.0
TLV77318PDQNR	X2SON	DQN	4	3000	210.0	185.0	35.0
TLV77325PDBVR	SOT-23	DBV	5	3000	210.0	185.0	35.0
TLV77325PDQNR	X2SON	DQN	4	3000	210.0	185.0	35.0
TLV77328PDBVR	SOT-23	DBV	5	3000	210.0	185.0	35.0
TLV77328PDQNR	X2SON	DQN	4	3000	210.0	185.0	35.0
TLV77333PDBVR	SOT-23	DBV	5	3000	210.0	185.0	35.0
TLV77333PDQNR	X2SON	DQN	4	3000	210.0	185.0	35.0

EXAMPLE STENCIL DESIGN

DBV0005A

SOT-23 - 1.45 mm max height

SMALL OUTLINE TRANSISTOR



SOLDER PASTE EXAMPLE
BASED ON 0.125 mm THICK STENCIL
SCALE:15X

4214839/K 08/2024

NOTES: (continued)

8. Laser cutting apertures with trapezoidal walls and rounded corners may offer better paste release. IPC-7525 may have alternate design recommendations.
9. Board assembly site may have different recommendations for stencil design.

GENERIC PACKAGE VIEW

DQN 4

X2SON - 0.4 mm max height

PLASTIC SMALL OUTLINE - NO LEAD



Images above are just a representation of the package family, actual package may vary.
Refer to the product data sheet for package details.

4210367/F



4215302/E 12/2016

NOTES:

1. All linear dimensions are in millimeters. Any dimensions in parenthesis are for reference only. Dimensioning and tolerancing per ASME Y14.5M.
2. This drawing is subject to change without notice.
3. The package thermal pad must be soldered to the printed circuit board for optimal thermal and mechanical performance.
4. Features may not exist. Recommend use of pin 1 marking on top of package for orientation purposes.
5. Shape of exposed side leads may differ.
6. Number and location of exposed tie bars may vary.



LAND PATTERN EXAMPLE
SCALE: 40X



SOLDER MASK DETAIL

4215302/E 12/2016

NOTES: (continued)

7. This package is designed to be soldered to a thermal pad on the board. For more information, see Texas Instruments literature number SLUA271 (www.ti.com/lit/sluea271).
8. If any vias are implemented, it is recommended that vias under paste be filled, plugged or tented.



SOLDER PASTE EXAMPLE
 BASED ON 0.075 - 0.1mm THICK STENCIL
 EXPOSED PAD
 88% PRINTED SOLDER COVERAGE BY AREA
 SCALE: 60X

4215302/E 12/2016

NOTES: (continued)

9. Laser cutting apertures with trapezoidal walls and rounded corners may offer better paste release. IPC-7525 may have alternate design recommendations.

IMPORTANT NOTICE AND DISCLAIMER

TI PROVIDES TECHNICAL AND RELIABILITY DATA (INCLUDING DATA SHEETS), DESIGN RESOURCES (INCLUDING REFERENCE DESIGNS), APPLICATION OR OTHER DESIGN ADVICE, WEB TOOLS, SAFETY INFORMATION, AND OTHER RESOURCES "AS IS" AND WITH ALL FAULTS, AND DISCLAIMS ALL WARRANTIES, EXPRESS AND IMPLIED, INCLUDING WITHOUT LIMITATION ANY IMPLIED WARRANTIES OF MERCHANTABILITY, FITNESS FOR A PARTICULAR PURPOSE OR NON-INFRINGEMENT OF THIRD PARTY INTELLECTUAL PROPERTY RIGHTS.

These resources are intended for skilled developers designing with TI products. You are solely responsible for (1) selecting the appropriate TI products for your application, (2) designing, validating and testing your application, and (3) ensuring your application meets applicable standards, and any other safety, security, regulatory or other requirements.

These resources are subject to change without notice. TI grants you permission to use these resources only for development of an application that uses the TI products described in the resource. Other reproduction and display of these resources is prohibited. No license is granted to any other TI intellectual property right or to any third party intellectual property right. TI disclaims responsibility for, and you will fully indemnify TI and its representatives against, any claims, damages, costs, losses, and liabilities arising out of your use of these resources.

TI's products are provided subject to [TI's Terms of Sale](#) or other applicable terms available either on [ti.com](https://www.ti.com) or provided in conjunction with such TI products. TI's provision of these resources does not expand or otherwise alter TI's applicable warranties or warranty disclaimers for TI products.

TI objects to and rejects any additional or different terms you may have proposed.

Mailing Address: Texas Instruments, Post Office Box 655303, Dallas, Texas 75265
Copyright © 2024, Texas Instruments Incorporated