

TPLD1201 Programmable Logic Device

1 Features

- Eight general purpose input or outputs:
 - Digital input can be configured with hysteresis, low-voltage thresholds, and internal pull-up or down resistor
 - Push-pull, open-drain (PMOS/NMOS), and Hi-Z outputs
- Supports 1.8 V, 2.5 V, 3.3 V, and 5 V applications
- Configurable macro-cells:
 - 2-, 3-, and 4-bit lookup tables (LUT)
 - D-type flip-flops or latches with and without reset or set option
 - Pipe delay – 8-stages, 2 outputs
 - Selectable counters or delay generators
 - Programmable deglitch filter or edge detector
 - Analog comparators – selectable VREF and input gain
 - Internal voltage reference fixed or ratiometric
 - 25 kHz and 2 MHz RC oscillator – internal divider stages
- Extended temperature range: -40°C to 125°C
- Development tools:
 - InterConnect Studio
 - TPLD1201 evaluation module
 - TPLD programming board

2 Applications

- [Factory automation and control](#)
- [Communications equipment](#)
- [Retail automation and payment](#)
- [Test and measurement](#)
- [Pro audio, video and signage](#)
- [Personal electronics](#)

3 Description

The TPLD1201 is part of the TI programmable logic device (TPLD) family of devices that feature versatile programmable logic ICs with combinational logic, sequential logic and mixed-signal functions. TPLD provides a fully integrated, low power solution to implement common system functions, such as timing delays, voltage monitors, system resets, power sequencers, I/O expanders, and more. This device features configurable I/O structures that extends compatibility within mixed-signal environments, reducing the number of discrete components required.

System designers can create circuits and configure the macro-cells, I/O pins, and interconnections by temporarily emulating the non-volatile memory or by permanently programming the one-time programmable (OTP) through InterConnect Studio. The TPLD1201 is supported by hardware and software ecosystem with application notes, reference designs and design examples. Visit [ti.com](https://www.ti.com) for more information and access to design tools.

Package information

PART NUMBER	PACKAGE ⁽¹⁾	PACKAGE SIZE ⁽²⁾
TPLD1201	RWB (X2QFN, 12)	1.6 mm × 1.6 mm

(1) For more information, see [Section 6](#).

(2) The package size (length × width) is a nominal value and includes pins, where applicable.



ADVANCE INFORMATION

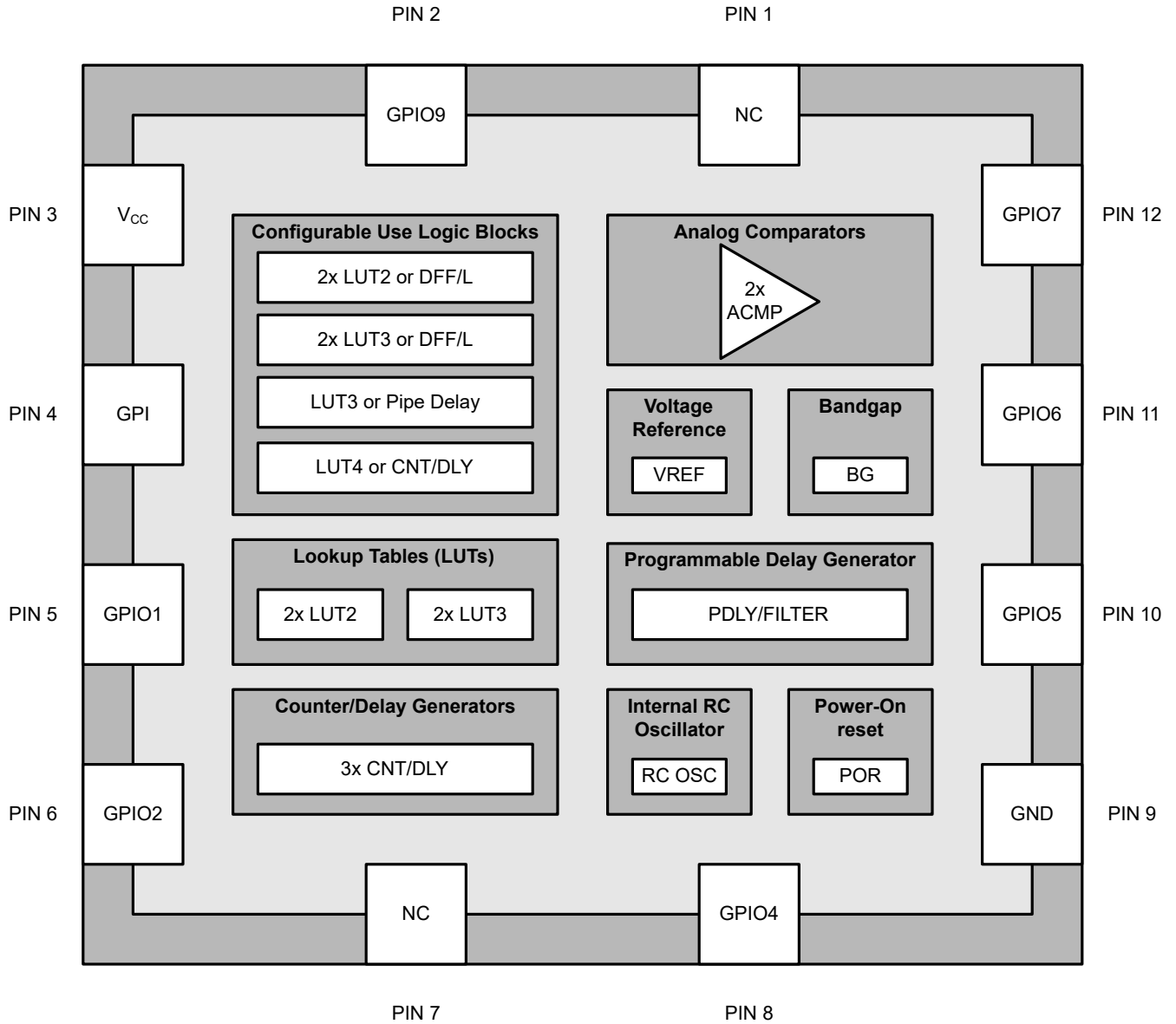

Functional Diagram

Table of Contents

1 Features	1	4.4 Electrostatic Discharge Caution.....	4
2 Applications	1	4.5 Glossary.....	4
3 Description	1	5 Revision History	4
4 Device and Documentation Support	4	6 Mechanical, Packaging, and Orderable Information	4
4.1 Receiving Notification of Documentation Updates.....	4	6.1 Tape and Reel Information.....	5
4.2 Support Resources.....	4	6.2 Mechanical Data.....	7
4.3 Trademarks.....	4		

4 Device and Documentation Support

4.1 Receiving Notification of Documentation Updates

To receive notification of documentation updates, navigate to the device product folder on ti.com. Click on *Notifications* to register and receive a weekly digest of any product information that has changed. For change details, review the revision history included in any revised document.

4.2 Support Resources

[TI E2E™ support forums](#) are an engineer's go-to source for fast, verified answers and design help — straight from the experts. Search existing answers or ask your own question to get the quick design help you need.

Linked content is provided "AS IS" by the respective contributors. They do not constitute TI specifications and do not necessarily reflect TI's views; see TI's [Terms of Use](#).

4.3 Trademarks

TI E2E™ is a trademark of Texas Instruments.
All trademarks are the property of their respective owners.

4.4 Electrostatic Discharge Caution



This integrated circuit can be damaged by ESD. Texas Instruments recommends that all integrated circuits be handled with appropriate precautions. Failure to observe proper handling and installation procedures can cause damage.

ESD damage can range from subtle performance degradation to complete device failure. Precision integrated circuits may be more susceptible to damage because very small parametric changes could cause the device not to meet its published specifications.

4.5 Glossary

[TI Glossary](#) This glossary lists and explains terms, acronyms, and definitions.

5 Revision History

DATE	REVISION	NOTES
November 2023	*	Initial Release

6 Mechanical, Packaging, and Orderable Information

The following pages include mechanical, packaging, and orderable information. This information is the most current data available for the designated devices. This data is subject to change without notice and revision of this document. For browser-based versions of this data sheet, refer to the left-hand navigation.

6.1 Tape and Reel Information

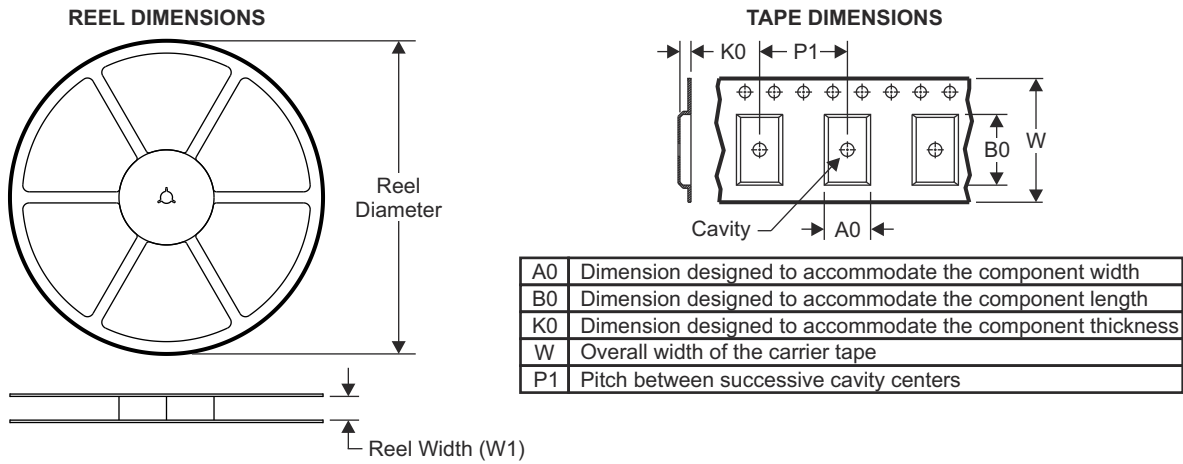

QUADRANT ASSIGNMENTS FOR PIN 1 ORIENTATION IN TAPE

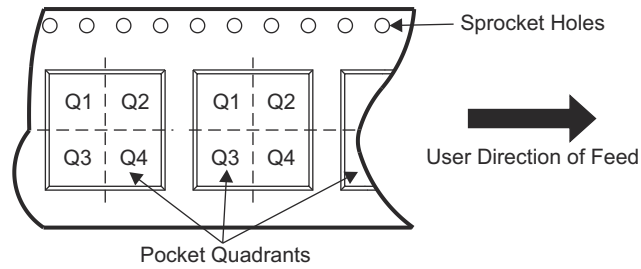

Device	Package Type	Package Drawing	Pins	SPQ	Reel Diameter (mm)	Reel Width W1 (mm)	A0 (mm)	B0 (mm)	K0 (mm)	P1 (mm)	W (mm)	Pin1 Quadrant
PTPLD1201RWBR	X2QFN	RWB	12	3000	180	8.4	1.8	1.8	0.48	4	8	2

ADVANCE INFORMATION

TAPE AND REEL BOX DIMENSIONS

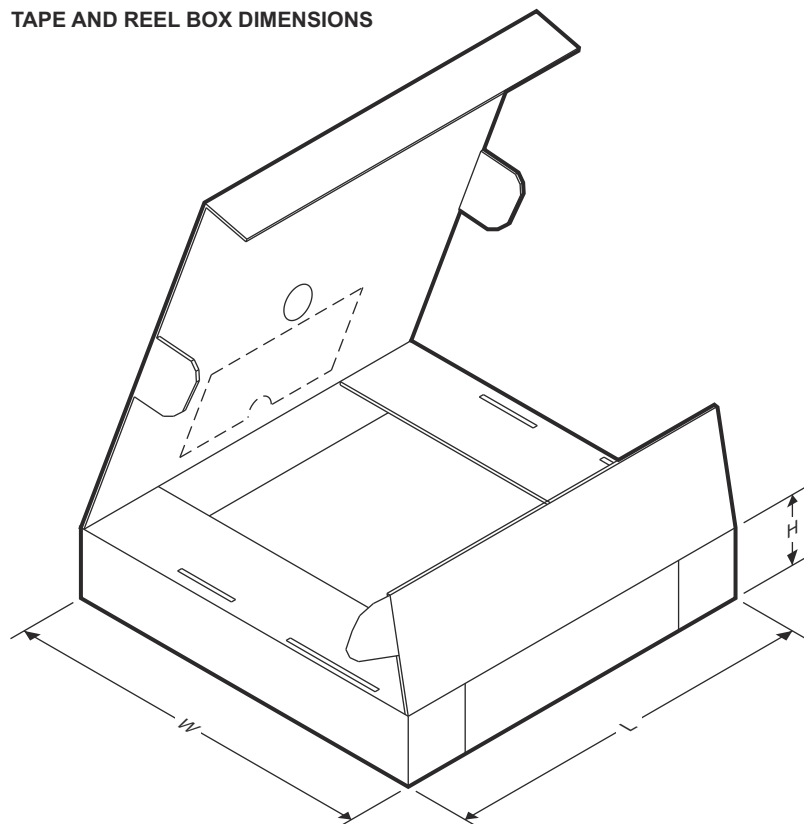

ADVANCE INFORMATION

Device	Package Type	Package Drawing	Pins	SPQ	Length (mm)	Width (mm)	Height (mm)
PTPLD1201RWBR	X2QFN	RWB	12	3000	210	185	35

6.2 Mechanical Data



PACKAGE OUTLINE

RWB0012A

X2QFN - 0.4 mm max height

PLASTIC QUAD FLATPACK - NO LEAD

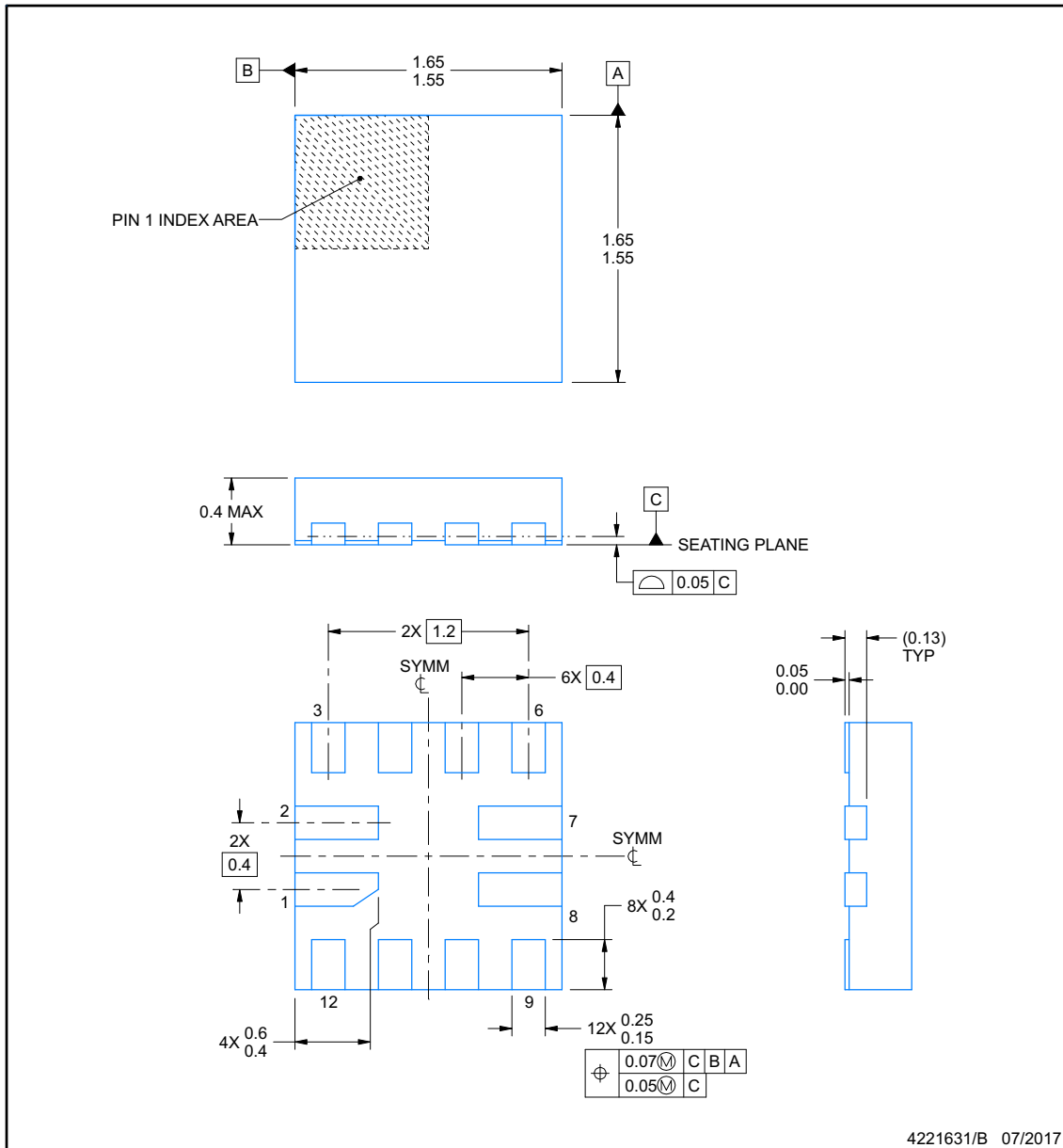

NOTES:

1. All linear dimensions are in millimeters. Any dimensions in parenthesis are for reference only. Dimensioning and tolerancing per ASME Y14.5M.
2. This drawing is subject to change without notice.

ADVANCE INFORMATION

EXAMPLE BOARD LAYOUT

RWB0012A

X2QFN - 0.4 mm max height

PLASTIC QUAD FLATPACK - NO LEAD

ADVANCE INFORMATION

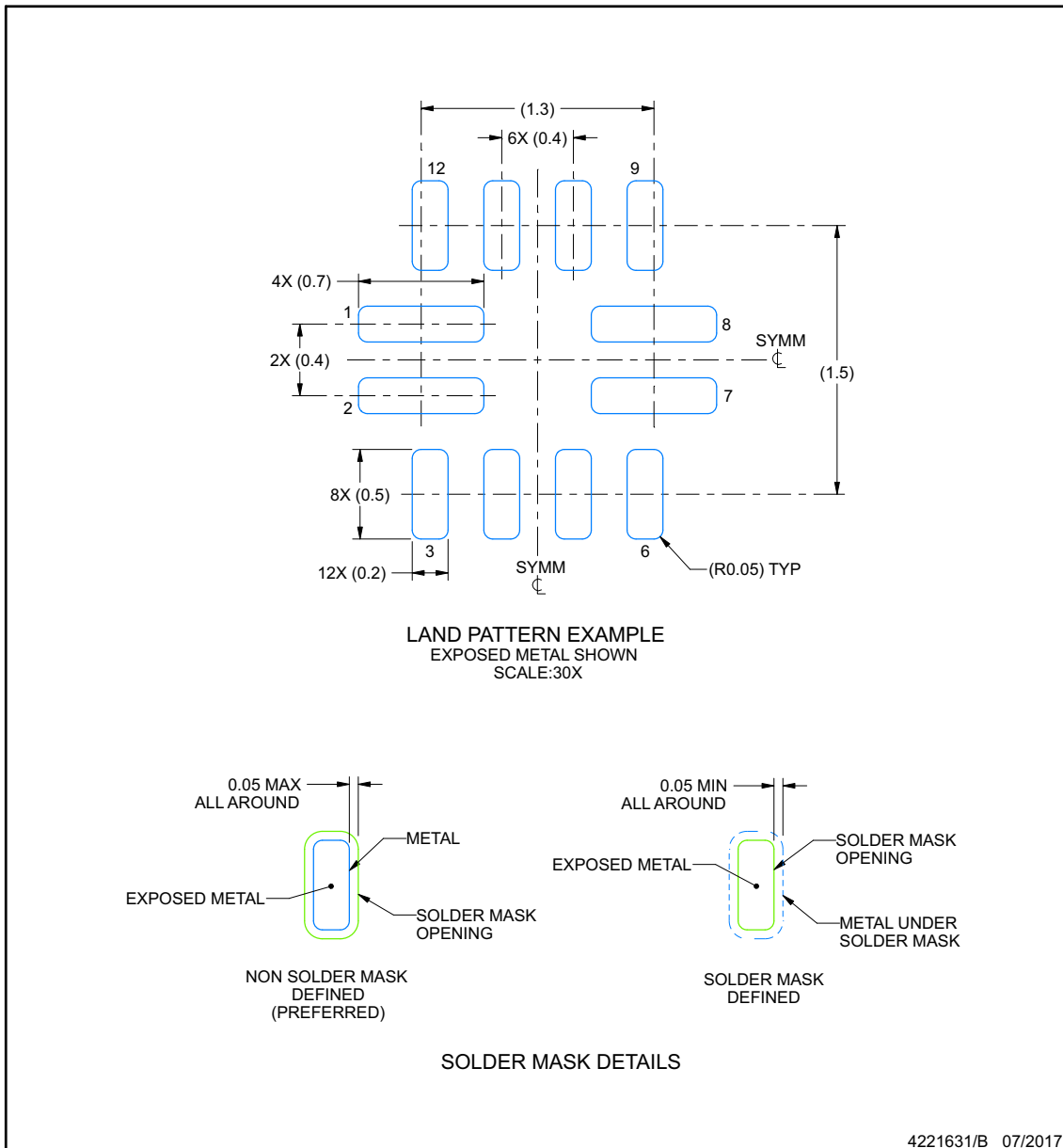

NOTES: (continued)

3. For more information, see Texas Instruments literature number SLUA271 (www.ti.com/lit/slua271).

EXAMPLE STENCIL DESIGN

RWB0012A

X2QFN - 0.4 mm max height

PLASTIC QUAD FLATPACK - NO LEAD

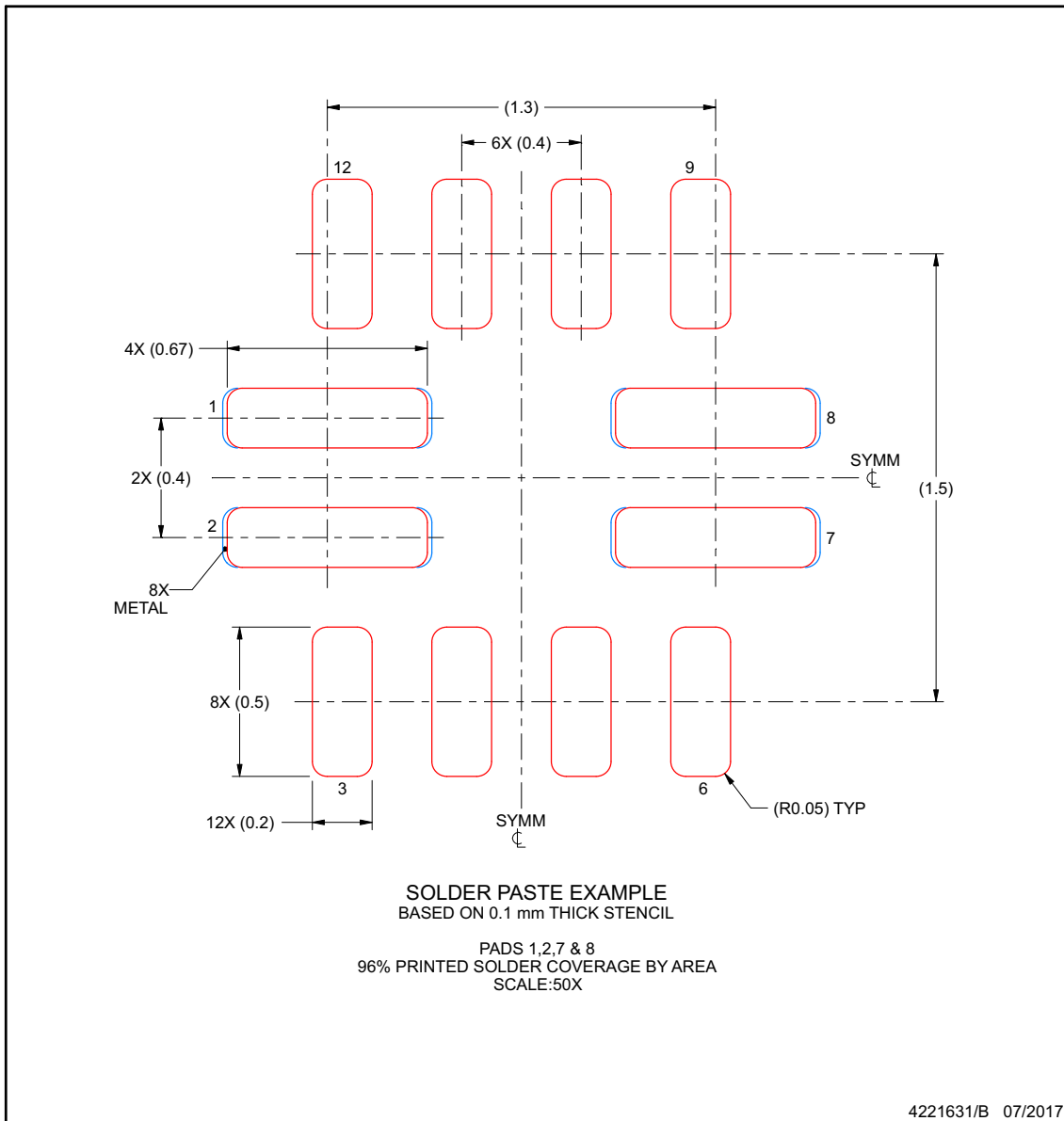

NOTES: (continued)

4. Laser cutting apertures with trapezoidal walls and rounded corners may offer better paste release. IPC-7525 may have alternate design recommendations.

ADVANCE INFORMATION

PACKAGING INFORMATION

Orderable Device	Status (1)	Package Type	Package Drawing	Pins	Package Qty	Eco Plan (2)	Lead finish/ Ball material (6)	MSL Peak Temp (3)	Op Temp (°C)	Device Marking (4/5)	Samples
PTPLD1201RWBR	ACTIVE	X2QFN	RWB	12	3000	TBD	Call TI	Call TI	-40 to 125		Samples

(1) The marketing status values are defined as follows:

ACTIVE: Product device recommended for new designs.

LIFEBUY: TI has announced that the device will be discontinued, and a lifetime-buy period is in effect.

NRND: Not recommended for new designs. Device is in production to support existing customers, but TI does not recommend using this part in a new design.

PREVIEW: Device has been announced but is not in production. Samples may or may not be available.

OBSELETE: TI has discontinued the production of the device.

(2) **RoHS:** TI defines "RoHS" to mean semiconductor products that are compliant with the current EU RoHS requirements for all 10 RoHS substances, including the requirement that RoHS substance do not exceed 0.1% by weight in homogeneous materials. Where designed to be soldered at high temperatures, "RoHS" products are suitable for use in specified lead-free processes. TI may reference these types of products as "Pb-Free".

RoHS Exempt: TI defines "RoHS Exempt" to mean products that contain lead but are compliant with EU RoHS pursuant to a specific EU RoHS exemption.

Green: TI defines "Green" to mean the content of Chlorine (Cl) and Bromine (Br) based flame retardants meet JS709B low halogen requirements of <=1000ppm threshold. Antimony trioxide based flame retardants must also meet the <=1000ppm threshold requirement.

(3) MSL, Peak Temp. - The Moisture Sensitivity Level rating according to the JEDEC industry standard classifications, and peak solder temperature.

(4) There may be additional marking, which relates to the logo, the lot trace code information, or the environmental category on the device.

(5) Multiple Device Markings will be inside parentheses. Only one Device Marking contained in parentheses and separated by a "-" will appear on a device. If a line is indented then it is a continuation of the previous line and the two combined represent the entire Device Marking for that device.

(6) Lead finish/Ball material - Orderable Devices may have multiple material finish options. Finish options are separated by a vertical ruled line. Lead finish/Ball material values may wrap to two lines if the finish value exceeds the maximum column width.

Important Information and Disclaimer:The information provided on this page represents TI's knowledge and belief as of the date that it is provided. TI bases its knowledge and belief on information provided by third parties, and makes no representation or warranty as to the accuracy of such information. Efforts are underway to better integrate information from third parties. TI has taken and continues to take reasonable steps to provide representative and accurate information but may not have conducted destructive testing or chemical analysis on incoming materials and chemicals. TI and TI suppliers consider certain information to be proprietary, and thus CAS numbers and other limited information may not be available for release.

In no event shall TI's liability arising out of such information exceed the total purchase price of the TI part(s) at issue in this document sold by TI to Customer on an annual basis.

IMPORTANT NOTICE AND DISCLAIMER

TI PROVIDES TECHNICAL AND RELIABILITY DATA (INCLUDING DATA SHEETS), DESIGN RESOURCES (INCLUDING REFERENCE DESIGNS), APPLICATION OR OTHER DESIGN ADVICE, WEB TOOLS, SAFETY INFORMATION, AND OTHER RESOURCES "AS IS" AND WITH ALL FAULTS, AND DISCLAIMS ALL WARRANTIES, EXPRESS AND IMPLIED, INCLUDING WITHOUT LIMITATION ANY IMPLIED WARRANTIES OF MERCHANTABILITY, FITNESS FOR A PARTICULAR PURPOSE OR NON-INFRINGEMENT OF THIRD PARTY INTELLECTUAL PROPERTY RIGHTS.

These resources are intended for skilled developers designing with TI products. You are solely responsible for (1) selecting the appropriate TI products for your application, (2) designing, validating and testing your application, and (3) ensuring your application meets applicable standards, and any other safety, security, regulatory or other requirements.

These resources are subject to change without notice. TI grants you permission to use these resources only for development of an application that uses the TI products described in the resource. Other reproduction and display of these resources is prohibited. No license is granted to any other TI intellectual property right or to any third party intellectual property right. TI disclaims responsibility for, and you will fully indemnify TI and its representatives against, any claims, damages, costs, losses, and liabilities arising out of your use of these resources.

TI's products are provided subject to [TI's Terms of Sale](#) or other applicable terms available either on [ti.com](https://www.ti.com) or provided in conjunction with such TI products. TI's provision of these resources does not expand or otherwise alter TI's applicable warranties or warranty disclaimers for TI products.

TI objects to and rejects any additional or different terms you may have proposed.

Mailing Address: Texas Instruments, Post Office Box 655303, Dallas, Texas 75265
Copyright © 2024, Texas Instruments Incorporated