

# TPS5683x 4.5V to 28V Input, 8A Synchronous Buck Converter

## 1 Features

- 4.5V to 28V input voltage range
- 0.6V to 13V output voltage range
- Supports 8A continuous output current
- Integrated 20.4mΩ and 9.5mΩ MOSFETs
- 0.6V ±1% reference voltage at 25°C
- 45uA low quiescent current of TPS56837
- D-CAP3™ control mode for fast transient response
- TPS56837 with Eco-mode (auto-skip mode) for high light-load efficiency
- TPS56838 with forced continuous conduction mode (FCCM)
- TPS56836 with Out-of-Audio™ (OOA) mode
- 500kHz, 800kHz, and 1200kHz selectable switching frequencies by mode selection
- Adjustable cycle-by-cycle over current limit for low-side MOSFETs by mode selection
- Adjustable soft-start time with default 1.8ms
- Built-in output discharge function
- Power-good indicator to monitor output voltage
- Supports up to 98% duty operation
- Non-latched protections for UV, OV, OT, and UVLO
- -40°C to +150°C operating junction temperature
- Small 10-pin 3.0mm × 3.0mm HotRod™ QFN Package
- Create a customer design using the TPS5683x with the [WEBENCH® Power Designer](#)
- Pin-to-pin compatible with 6A [TPS56637](#) and 8A [TPS56837H](#)

## 2 Applications

- [Industrial PC, EPOS, factory automation and control](#)
- [Multifunction printers, video conference system](#)
- [Monitors, TV, speakers, PC and notebooks, portable electronics](#)
- [General purposes for 12V, 19V, 24V power-bus supply](#)

## 3 Description

The TPS5683x is a high-efficiency, easy-to-use, synchronous buck converter with a wide input voltage range of 4.5V to 28V. The device supports up to 8A continuous output current at output voltages between 0.6V and 13V.

The TPS5683x uses D-CAP3 control mode to provide fast transient response, good line and load regulation, no requirement for external compensation, and supports low equivalent series resistance (ESR) output capacitors like MLCC.

The TPS56837 operates at Eco-mode to attain high efficiency at light load. The TPS56838 operates in forced continuous conduction mode which maintains lower output ripple during all load conditions. The TPS56836 operates in Out-of-Audio mode to avoid audible noise.

The TPS5683x has three selectable switching frequencies, 500kHz, 800kHz, and 1200kHz, and selectable current limit through MODE pin configuration. The TPS5683x has adjustable soft-start time by connecting the SS capacitor and with default 1.8ms with the SS pin floating.

The TPS5683x provides complete non-latched OV (overvoltage), UV (undervoltage), OC (overcurrent), OT (overtemperature) and UVLO (undervoltage lockout) protections combined with power-good indicator and output discharge function features.

The TPS5683x is available in a 10-pin, 3.0mm × 3.0mm, HotRod QFN package, and the junction temperature is specified from -40°C to 150°C.

### Device Information

PART NUMBER	MODE	PACKAGE AND PACKAGE SIZE <sup>(1) (2)</sup>
TPS56837	ECO	RPA (VQFN-HR, 10), 3.00mm × 3.00mm
TPS56838	FCCM	
TPS56836	OOA	

- (1) For more information, see [Section 10](#).
- (2) The package size (length × width) is a nominal value and includes pins, where applicable.

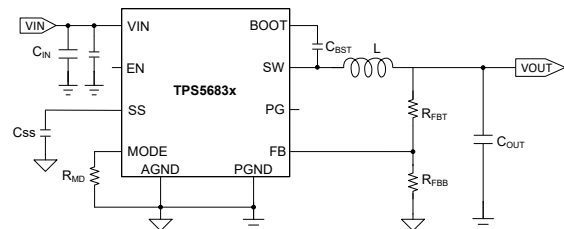

Simplified Schematic

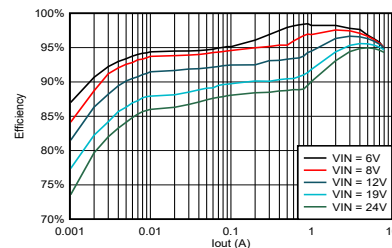

TPS56837 Efficiency, Vout = 5V, Fsw = 500kHz



## Table of Contents

<b>1 Features</b> .....	<b>1</b>	<b>7 Application and Implementation</b> .....	<b>17</b>
<b>2 Applications</b> .....	<b>1</b>	7.1 Application Information.....	17
<b>3 Description</b> .....	<b>1</b>	7.2 Typical Application.....	17
<b>4 Pin Configuration and Functions</b> .....	<b>3</b>	7.3 Power Supply Recommendations.....	23
<b>5 Specifications</b> .....	<b>4</b>	7.4 Layout.....	23
5.1 Absolute Maximum Ratings.....	4	<b>8 Device and Documentation Support</b> .....	<b>25</b>
5.2 ESD Ratings.....	4	8.1 Device Support.....	25
5.3 Recommended Operating Conditions.....	4	8.2 Documentation Support.....	25
5.4 Thermal Information.....	5	8.3 Receiving Notification of Documentation Updates....	25
5.5 Electrical Characteristics.....	5	8.4 Support Resources.....	25
5.6 Typical Characteristics.....	7	8.5 Trademarks.....	25
<b>6 Detailed Description</b> .....	<b>11</b>	8.6 Electrostatic Discharge Caution.....	25
6.1 Overview.....	11	8.7 Glossary.....	25
6.2 Functional Block Diagram.....	12	<b>9 Revision History</b> .....	<b>26</b>
6.3 Feature Description.....	12	<b>10 Mechanical, Packaging, and Orderable Information</b> .....	<b>26</b>
6.4 Device Functional Modes.....	16		

## 4 Pin Configuration and Functions

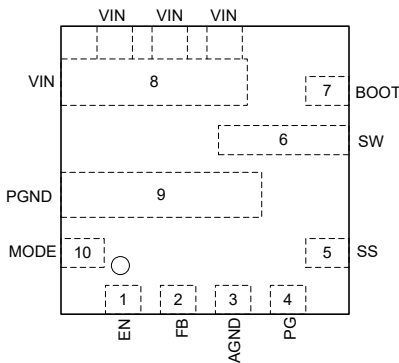

**Figure 4-1. RPA Package, 10-Pin VQFN-HR Top View**

**Table 4-1. Pin Functions**

PIN		TYPE <sup>(1)</sup>	DESCRIPTION
NAME	NO.		
EN	1	I	Enable input control. Driving EN high or leaving this pin floating enables the converter. A resistor divider between this pin, VIN and AGND can be used to implement an external UVLO.
FB	2	I	Output feedback. Connect FB to the output voltage with a feedback resistor divider.
AGND	3	G	Ground of internal analog circuitry. Connect AGND to PGND plane at a single point.
PG	4	O	Open drain power-good indicator, this pin is asserted low if output voltage is out of PG threshold due to overvoltage, undervoltage, thermal shutdown, EN shutdown, or during soft start.
SS	5	O	Soft-start time selection pin. Connecting an external capacitor to AGND to set the soft-start time and if no external capacitor is connected, the soft-start time is 1.8ms by default.
SW	6	O	Switching node terminal. Connect the output inductor to this pin with wide and short tracks.
BOOT	7	I	Supply input for the gate drive voltage of the high-side MOSFET. Connect a 0.1µF bootstrap capacitor between BOOT and SW.
VIN	8	P	Input voltage supply pin. Drain terminal of high-side MOSFET. Connect the input decoupling capacitors between VIN and PGND.
PGND	9	G	Power GND terminal. Source terminal of low-side MOSFET.
MODE	10	I	Switching frequency and current limit selection pin. Connect this pin with a resistor to AGND for different MODE options shown in <a href="#">Table 6-1</a> .

(1) I = Input, P = Power, G = Ground, O = Output.

## 5 Specifications

### 5.1 Absolute Maximum Ratings

Over the recommended operating junction temperature range of  $-40^{\circ}\text{C}$  to  $+150^{\circ}\text{C}$  (unless otherwise noted)<sup>(1)</sup>

		MIN	MAX	UNIT
Input voltage	V <sub>IN</sub>	-0.3	32	V
	BOOT	-0.3	SW + 6	V
	BOOT - SW	-0.3	6	V
	EN, FB, MODE	-0.3	6	V
	PGND, AGND	-0.3	0.3	V
Output voltage	SW	-2	32	V
	SW (<10ns transient)	-5	35	V
	PG, SS	-0.3	6	V
Operating junction temperature, T <sub>J</sub>		-40	150	$^{\circ}\text{C}$
Storage temperature, T <sub>stg</sub>		-65	150	$^{\circ}\text{C}$

- (1) Operation outside the Absolute Maximum Ratings may cause permanent device damage. Absolute Maximum Ratings do not imply functional operation of the device at these or any other conditions beyond those listed under Recommended Operating Conditions. If used outside the Recommended Operating Conditions but within the Absolute Maximum Ratings, the device may not be fully functional, and this may affect device reliability, functionality, performance, and shorten the device lifetime.

### 5.2 ESD Ratings

			VALUE	UNIT
V <sub>ESD</sub>	Electrostatic discharge	Human body model (HBM), per ANSI/ESDA/JEDEC JS-001 <sup>(1)</sup>	$\pm 2000$	V
		Charged device model (CDM), per ANSI/ESDA/JEDEC JS-002 <sup>(2)</sup>	$\pm 500$	

- (1) JEDEC document JEP155 states that 500V HBM allows safe manufacturing with a standard ESD control process.  
 (2) JEDEC document JEP157 states that 250V CDM allows safe manufacturing with a standard ESD control process.

### 5.3 Recommended Operating Conditions

Over the recommended operating junction temperature range of  $-40^{\circ}\text{C}$  to  $150^{\circ}\text{C}$  (unless otherwise noted)<sup>(1)</sup>

		MIN	NOM	MAX	UNIT
Input voltage	V <sub>IN</sub>	4.5		28	V
	BOOT	-0.1		SW + 5.5	
	BOOT - SW	-0.1		5.5	V
	EN, FB, SS, MODE	-0.1		5.5	V
	PGND, AGND	-0.1		0.1	V
Output voltage	SW	-1		28	V
	PG	-0.1		5.5	V
Operating junction temperature, T <sub>J</sub>		-40		150	$^{\circ}\text{C}$

## 5.4 Thermal Information

THERMAL METRIC <sup>(1)</sup>		TPS5683x	UNIT
		QFN HotRod	
		10 PINS	
R <sub>θJA</sub>	Junction-to-ambient thermal resistance (JEDEC) <sup>(2)</sup>	68.1	°C/W
Eff R <sub>θJA</sub>	Effective junction-to-ambient thermal resistance (4-layer TI EVM)	30	°C/W
R <sub>θJC(top)</sub>	Junction-to-case (top) thermal resistance	40.4	°C/W
R <sub>θJB</sub>	Junction-to-board thermal resistance	17.6	°C/W
Ψ <sub>JT</sub>	Junction-to-top characterization parameter	1.4	°C/W
Ψ <sub>JB</sub>	Junction-to-board characterization parameter	17.2	°C/W

- (1) For more information about traditional and new thermal metrics, see the [Semiconductor and IC Package Thermal Metrics](#).  
(2) This junction-to-ambient thermal resistance (JEDEC) is based on JEDEC standard EVM without GND thermal vias.

## 5.5 Electrical Characteristics

The electrical ratings specified in this section apply to all specifications in this document unless otherwise noted. These specifications are interpreted as conditions that do not degrade the parametric or functional specifications of the device for the life of the product containing it. Typical values correspond to T<sub>J</sub> = 25°C, V<sub>IN</sub> = 24V. Minimum and maximum limits are based on T<sub>J</sub> = -40°C to +150°C, V<sub>IN</sub> = 4.5V to 28V (unless otherwise noted).

PARAMETER		TEST CONDITIONS	MIN	TYP	MAX	UNIT
<b>SUPPLY CURRENT</b>						
I <sub>Q</sub>	Nonswitching Quiescent current <sup>(1)</sup>	T <sub>J</sub> = 25°C, V <sub>EN</sub> = 5V, V <sub>FB</sub> = 0.65V, TPS56837		45		μA
		T <sub>J</sub> = 25°C, V <sub>EN</sub> = 5V, V <sub>FB</sub> = 0.7V, TPS56838		370		
I <sub>SHDNN</sub>	Shutdown supply current	T <sub>J</sub> = 25°C, V <sub>EN</sub> = 0V		3		μA
<b>UVLO</b>						
UVLO	V <sub>IN</sub> undervoltage lockout	Wake up V <sub>IN</sub> voltage	4.0	4.2	4.4	V
		Shutdown V <sub>IN</sub> voltage	3.5	3.65	3.8	V
		Hysteresis V <sub>IN</sub> voltage		550		mV
<b>ENABLE(EN PIN)</b>						
I <sub>EN_PULLUP</sub>	EN pullup current	V <sub>EN</sub> = 1.1V		1		μA
I <sub>EN_HYS</sub>	Hysteresis current	V <sub>EN</sub> = 1.3V		3		μA
V <sub>EN_ON</sub>	Enable threshold	EN rising		1.18	1.26	V
V <sub>EN_OFF</sub>		EN falling	1	1.07		V
<b>FEEDBACK VOLTAGE</b>						
V <sub>FB</sub>	Feedback voltage	V <sub>OUT</sub> = 5V, continuous mode operation, T <sub>J</sub> = 25°C	0.594	0.6	0.606	V
		V <sub>OUT</sub> = 5V, continuous mode operation, T <sub>J</sub> = -40°C to 150°C	0.591	0.6	0.609	V
<b>MOSFET</b>						
R <sub>ds(on)_HS</sub>	High-side MOSFET on-resistance	T <sub>J</sub> = 25°C, V <sub>BST</sub> - V <sub>SW</sub> = 5V		20.4		mΩ
R <sub>ds(on)_LS</sub>	Low-side MOSFET on-resistance	T <sub>J</sub> = 25°C		9.5		mΩ
<b>CURRENT LIMIT</b>						
I <sub>LS_OCL</sub>	Low-side MOSFET valley current limit	ILIM-1 option	6	7.2	8.5	A
		ILIM option	8	9.6	11.1	

## 5.5 Electrical Characteristics (continued)

The electrical ratings specified in this section apply to all specifications in this document unless otherwise noted. These specifications are interpreted as conditions that do not degrade the parametric or functional specifications of the device for the life of the product containing it. Typical values correspond to  $T_J = 25^\circ\text{C}$ ,  $V_{IN} = 24\text{V}$ . Minimum and maximum limits are based on  $T_J = -40^\circ\text{C}$  to  $+150^\circ\text{C}$ ,  $V_{IN} = 4.5\text{V}$  to  $28\text{V}$  (unless otherwise noted).

PARAMETER		TEST CONDITIONS	MIN	TYP	MAX	UNIT
$I_{HS\_OCL}$	High-side MOSFET peak current limit		12.75	15	17.25	A
$I_{NOCL}$	Low-side MOSFET negative current limit		2.5			A
<b>DUTY CYCLE and FREQUENCY CONTROL</b>						
$F_{SW}$	Switching frequency	$V_{IN} = 24\text{V}$ , $V_{OUT} = 5\text{V}$ , continuous mode operation, Mode setting to 500kHz		500		kHz
$t_{OOA}$	OOA period	TPS56836 OOA operation period		30		us
$t_{ON(MIN)}$	Minimum on time <sup>(2)</sup>			50		ns
$t_{OFF(MIN)}$	Minimum off time <sup>(2)</sup>	$T_J = 25^\circ\text{C}$		150		ns
<b>SOFT START</b>						
$t_{SS}$	Internal soft-start time			1.8		ms
$I_{SS}$	Soft-start charging current			6		uA
<b>POWER GOOD</b>						
$V_{PGTH}$	PG lower threshold - falling	% of $V_{FB}$		85%		
	PG lower threshold - rising	% of $V_{FB}$		90%		
	PG upper threshold - falling	% of $V_{FB}$		110%		
	PG upper threshold - rising	% of $V_{FB}$		115%		
$I_{PGSINK}$	PG sink current	$V_{FB} = 0.5\text{V}$ , $V_{PG} = 0.4\text{V}$	10			mA
$t_{PG\_DLY}$	PG delay	PG from low-to-high		64		us
		PG from high-to-low		32		us
$V_{OVP}$	Output OVP threshold	OVP detect		125%		
$t_{OVP\_DEG}$	OVP propagation deglitch	$T_J = 25^\circ\text{C}$		32		us
$V_{UVP}$	Output UVP threshold	Hiccup detect		65%		
$t_{UVP\_WAIT}$	UV protection hiccup wait time			256		us
$t_{UVP\_HICCUP}$	UV protection hiccup time before recovery			$10.5 \times t_{SS}$		s
<b>THERMAL SHUTDOWN</b>						
Thermal shutdown threshold <sup>(3)</sup>	Temperature Rising		150	165		$^\circ\text{C}$
	Hysteresis			30		$^\circ\text{C}$
<b>SW DISCHARGE RESISTANCE</b>						
$V_{OUT}$ discharge resistance		$V_{EN} = 0$ , $V_{SW} = 0.5\text{V}$ , $T_J = 25^\circ\text{C}$		200		$\Omega$

(1) Not representative of the total input current of the system when in regulation. Specified by design and characterization test.

(2) Not production tested. Specified by design.

(3) Not production tested. Specified by design and engineering sample correlation.

## 5.6 Typical Characteristics

$V_{IN} = 24V$  (unless otherwise noted).

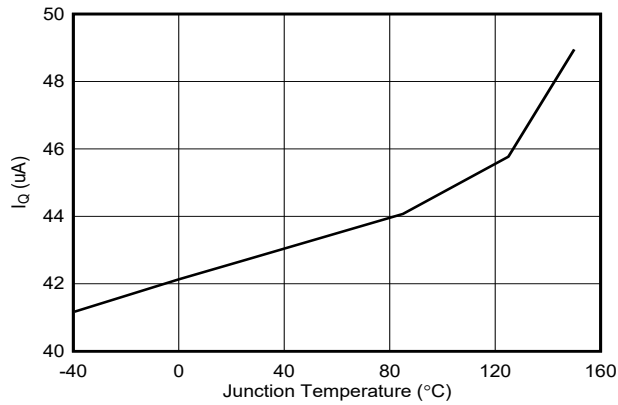

**Figure 5-1. TPS56837 Quiescent Current vs Temperature**

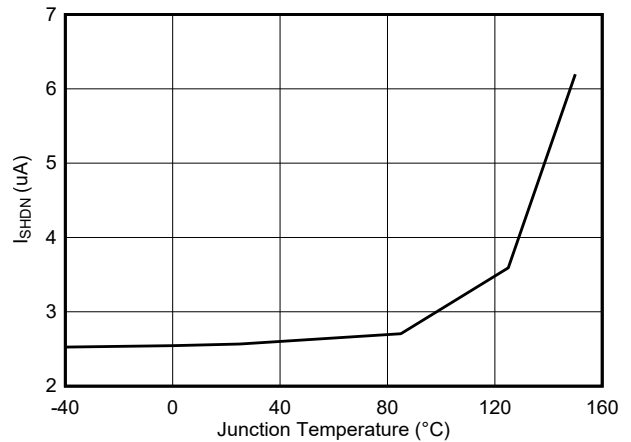

**Figure 5-2. Shutdown Current vs Temperature**

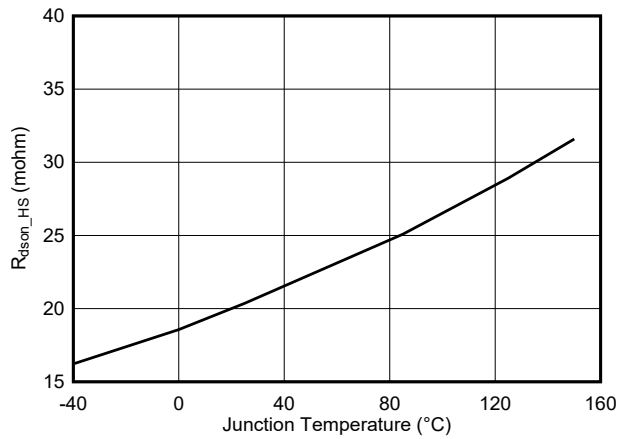

**Figure 5-3. High-Side  $R_{DS(on)}$  vs Temperature**

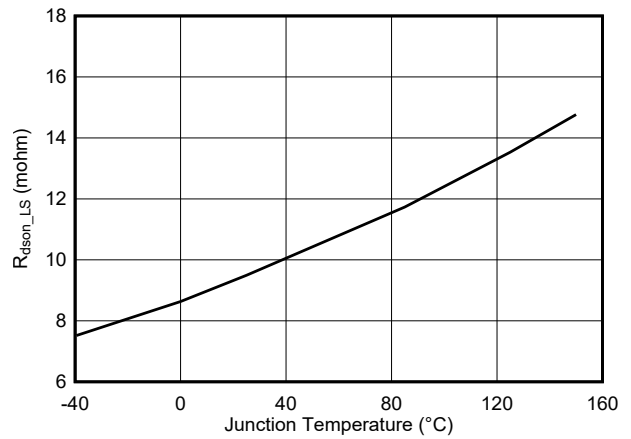

**Figure 5-4. Low-Side  $R_{DS(on)}$  vs Temperature**

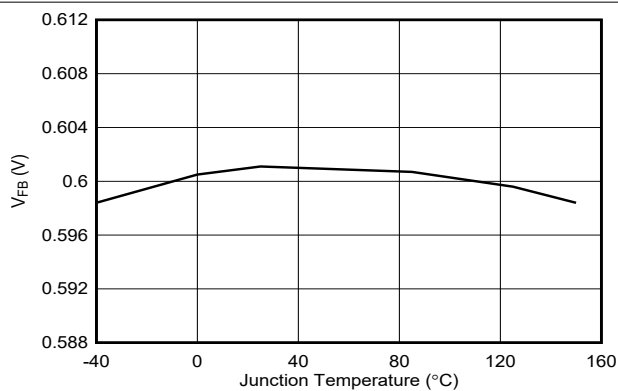

**Figure 5-5. Feedback Voltage vs Temperature**

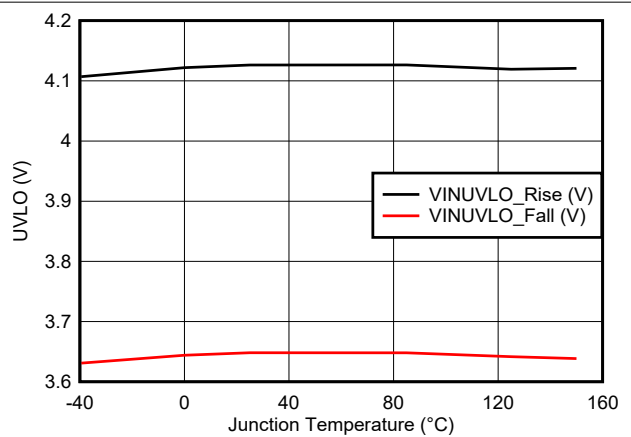

**Figure 5-6. VIN UVLO vs Temperature**

## 5.6 Typical Characteristics (continued)

$V_{IN} = 24V$  (unless otherwise noted).

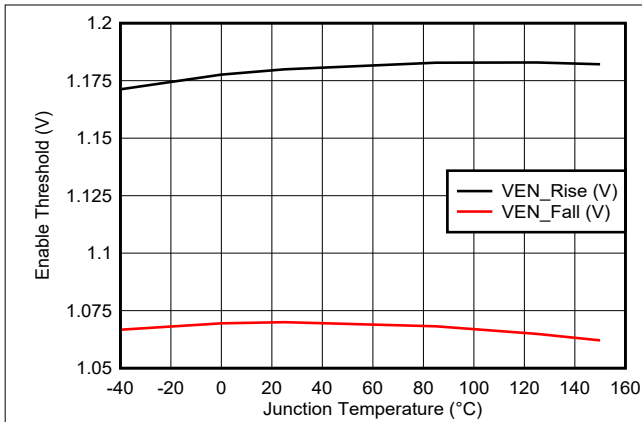

**Figure 5-7. EN Threshold vs Temperature**

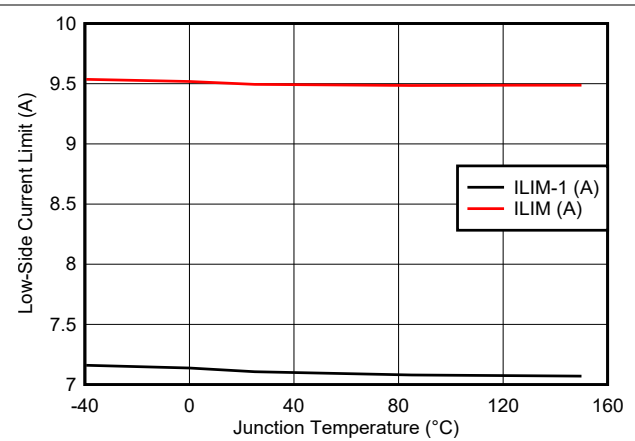

**Figure 5-8. Low-Side Valley Current Limit vs Temperature**

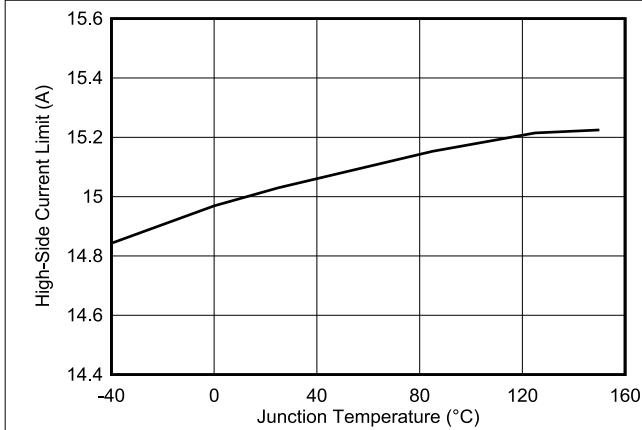

**Figure 5-9. High-side Peak Current Limit vs Temperature**

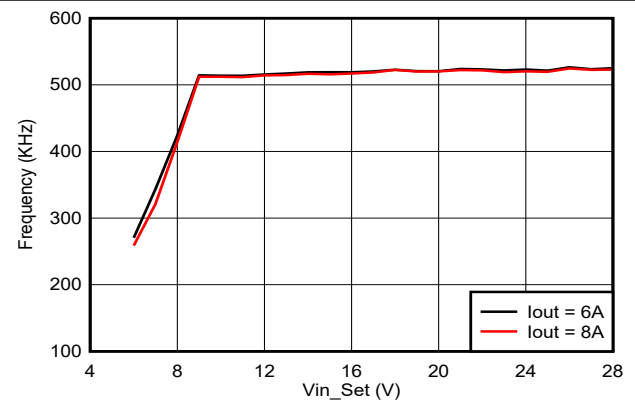

**Figure 5-10. Switching Frequency vs Input Voltage, Vout = 5V, Fsw = 500kHz**

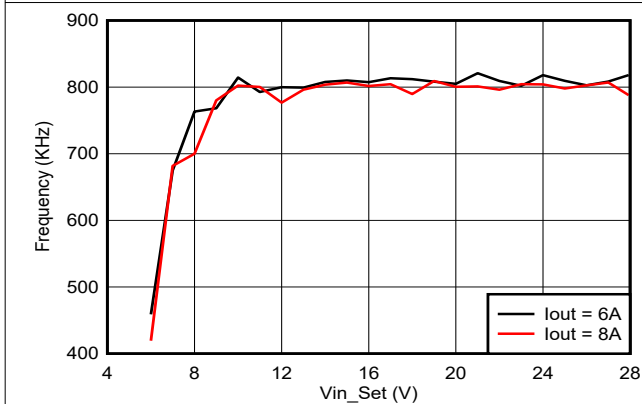

**Figure 5-11. Switching Frequency vs Input Voltage, Vout = 5V, Fsw = 800kHz**

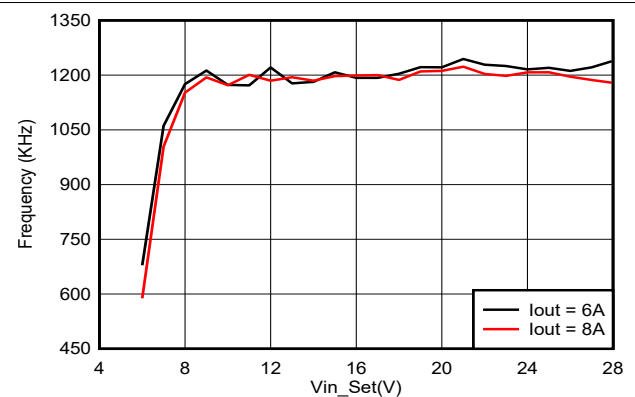
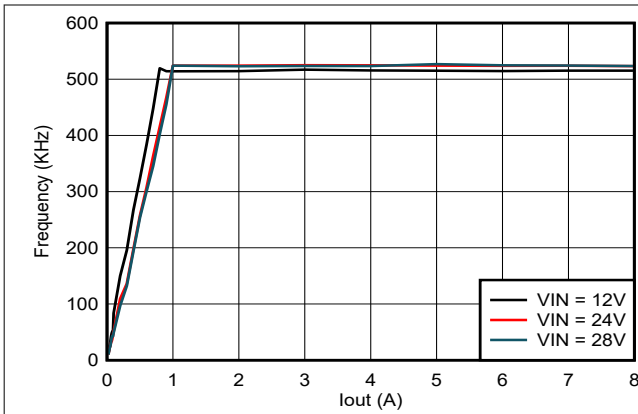

**Figure 5-12. Switching Frequency vs Input Voltage, Vout = 5V, Fsw = 1200kHz**



### 5.6 Typical Characteristics (continued)

$V_{IN} = 24V$  (unless otherwise noted).



**Figure 5-13. TPS56837 Switching Frequency vs Output Current,  $V_{out} = 5V$ ,  $F_{sw} = 500kHz$**

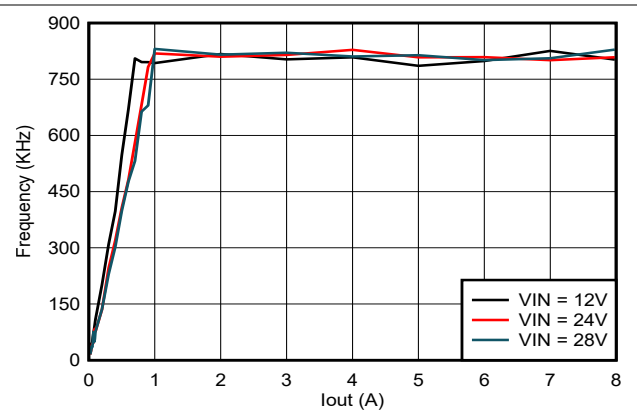

**Figure 5-14. TPS56837 Switching Frequency vs Output Current,  $V_{out} = 5V$ ,  $F_{sw} = 800kHz$**

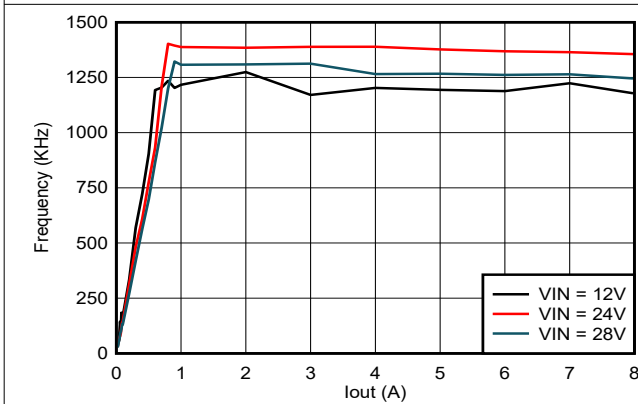

**Figure 5-15. TPS56837 Switching Frequency vs Output Current,  $V_{out} = 5V$ ,  $F_{sw} = 1200kHz$**

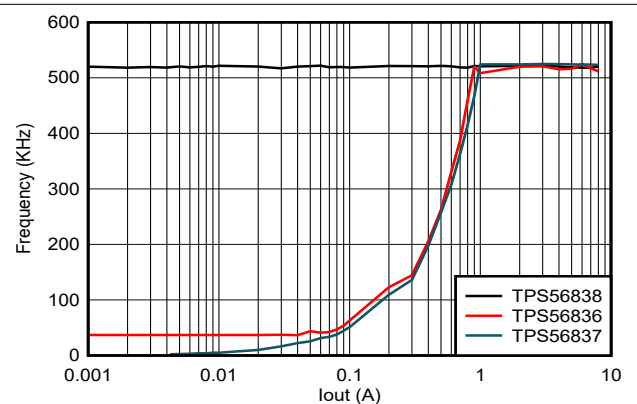

**Figure 5-16. TPS56837, TPS56838 and TPS56836 Switching Frequency vs Output Current,  $V_{in} = 24V$ ,  $V_{out} = 5V$ ,  $F_{sw} = 500kHz$**

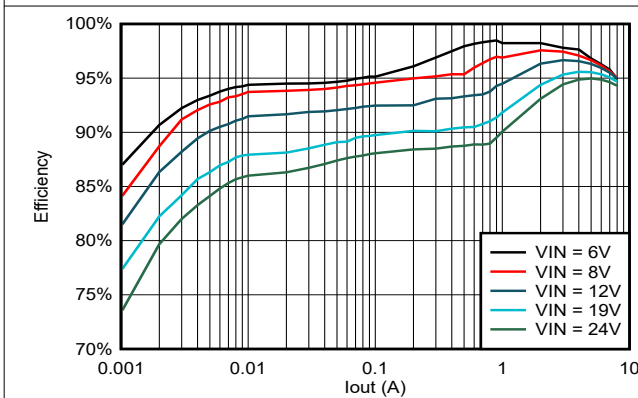

**Figure 5-17. TPS56837 Efficiency,  $V_{out} = 5V$ ,  $F_{sw} = 500kHz$**

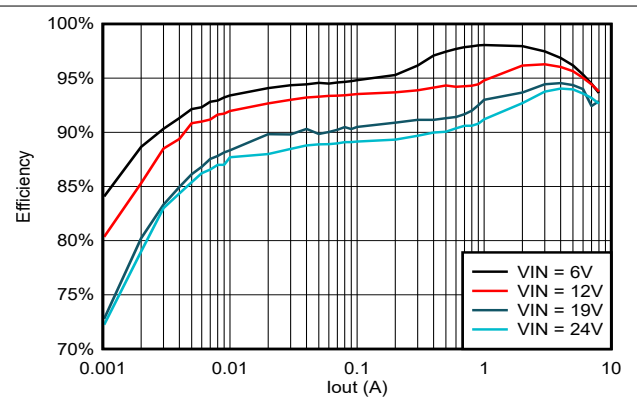

**Figure 5-18. TPS56837 Efficiency,  $V_{out} = 5V$ ,  $F_{sw} = 800kHz$**

## 5.6 Typical Characteristics (continued)

$V_{IN} = 24V$  (unless otherwise noted).

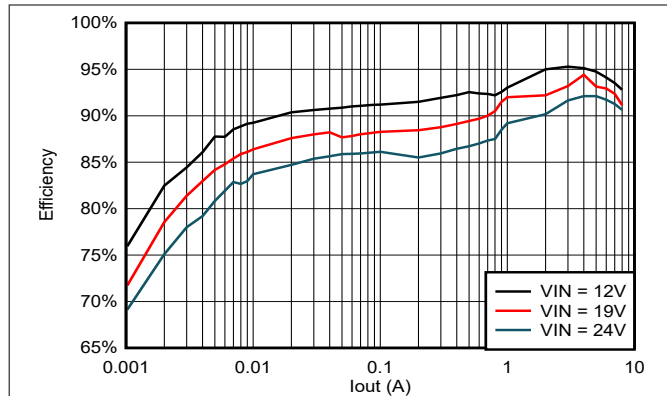

**Figure 5-19. TPS56837 Efficiency,  $V_{out} = 5V$ ,  $F_{sw} = 1200kHz$**

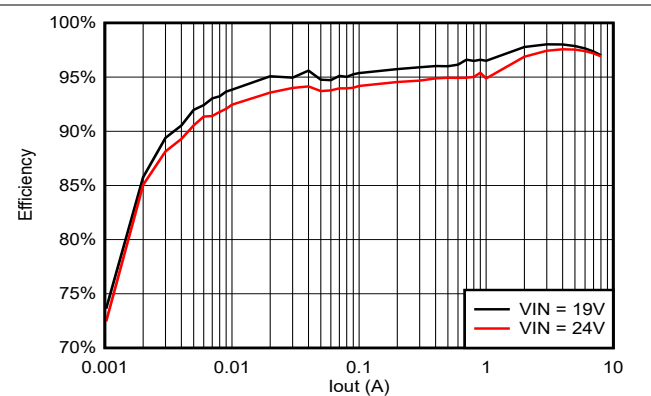

**Figure 5-20. TPS56837 Efficiency,  $V_{out} = 12V$ ,  $F_{sw} = 500kHz$**

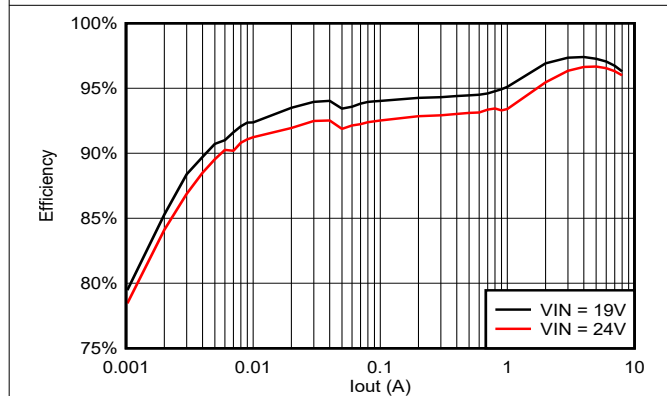

**Figure 5-21. TPS56837 Efficiency,  $V_{out} = 12V$ ,  $F_{sw} = 800kHz$**

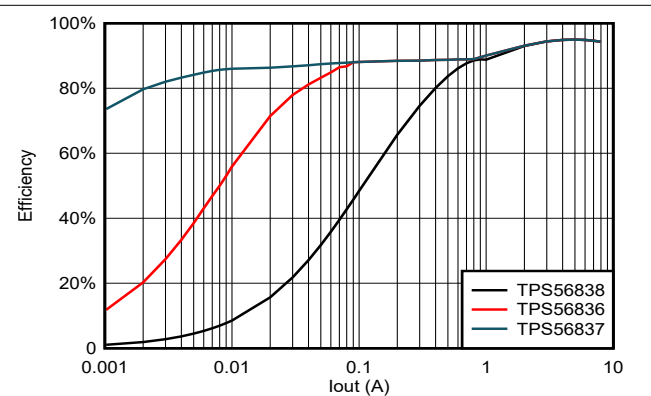

**Figure 5-22. TPS56837, TPS56838 and TPS56836 Efficiency,  $V_{in} = 24V$ ,  $V_{out} = 5V$ ,  $F_{sw} = 500kHz$**

## 6 Detailed Description

### 6.1 Overview

The TPS5683x is an 8A synchronous buck converter operating from 4.5V to 28V input voltage ( $V_{in}$ ). The device output voltage ranges from 0.6V to 13V ( $V_{out}$ ) and supports 8A continuous output current. The proprietary D-CAP3 control mode enables low external component count, ease of design, optimization of the power design for power, size and efficiency. The device employs D-CAP3 control mode that provides fast transient response with no external compensation components and an accurate feedback voltage. The TPS5683x is able to adapt both low equivalent series resistance (ESR) output capacitors such as POSCAP or SP-CAP, and ultra-low ESR ceramic capacitors.

The TPS56837 operates at Eco-mode to attain high efficiency at light load. The TPS56838 operates in forced continuous conduction mode (FCCM) which maintains lower output ripple during all load conditions. The TPS56836 operates in Out-of Audio mode (OOA) to avoid audible noise.

The TPS5683x has three selectable switching frequencies ( $F_{sw}$ ): 500kHz, 800kHz, and 1200kHz. These frequencies give the flexibility to optimize the design for higher efficiency with smaller size. There are two selectable current limits (ILIM-1, ILIM). All of these options are configured by connecting right MODE resistor between MODE and AGND pin.

The EN pin has an internal pullup current that can be used to adjust the input voltage undervoltage lockout (UVLO) with two external resistors. In addition, the EN pin can be floating for the device to operate with the internal pullup current. Soft-start time can be set by connecting a capacitor to the SS pin. Leaving SS pin floating is set to default 1.8ms soft-start time. The TPS5683x has PG pin to indicate output status and has a built in discharge function by using an integrated MOSFET with  $200\Omega R_{DS(on)}$ . The device is protected from output short, undervoltage, overvoltage, and overtemperature conditions.

## 6.2 Functional Block Diagram

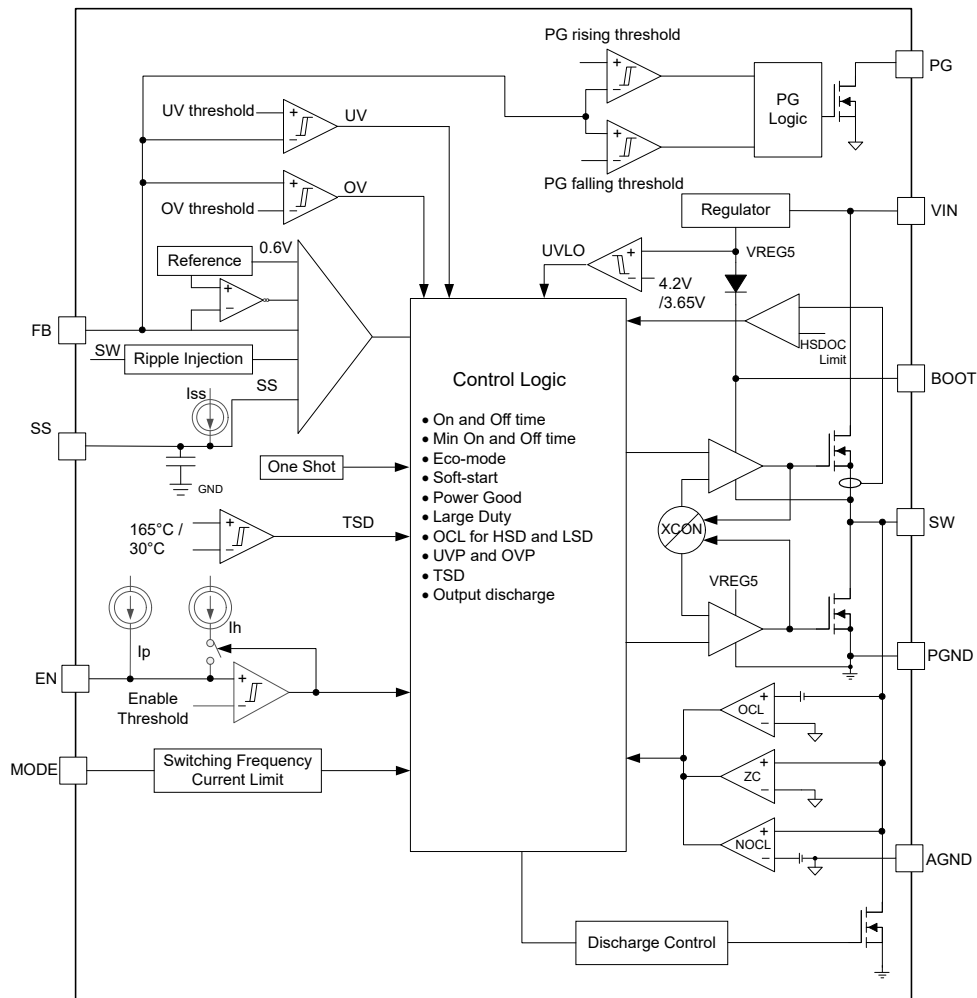

## 6.3 Feature Description

### 6.3.1 The Adaptive On-Time Control and PWM Operation

The main control loop of the TPS5683x is adaptive on-time pulse width modulation (PWM) controller that supports a proprietary D-CAP3 control mode. The D-CAP3 control mode combines adaptive on-time control with an internal compensation circuit for quasi-fixed frequency and low external component count configuration with both low-ESR and ceramic output capacitors. The D-CAP3 control mode is stable even with virtually no ripple at the output. The TPS5683x also includes an error amplifier that makes the output voltage very accurate. No external current sense network or loop compensation is required for D-CAP3 control mode topology.

At the beginning of each cycle, the high-side MOSFET is turned on. This MOSFET is turned off after an internal one-shot timer expires. This one-shot duration is set proportional to the output voltage  $V_{OUT}$ , and is inversely proportional to the converter input voltage  $V_{IN}$ , to maintain a pseudo-fixed frequency over the input voltage range, hence it is called adaptive on-time control. When the feedback voltage falls below the reference voltage, the one-shot timer is reset and the high-side MOSFET is turned on again. An internal ripple generation circuit is added to reference voltage for emulating the output ripple, and this enables the use of very low-ESR output capacitors such as multi-layered ceramic caps (MLCC).

### 6.3.2 Mode Selection

TPS5683x has a MODE pin that can offer six different states of operation as a combination of switching frequency and low-side MOSFET valley current limit. The device reads the voltage on the MODE pin during

start-up and latches onto one of the MODE options listed in Table 6-1. The voltage on the MODE pin can be set by connecting a resistor to AGND. A guideline for the MODE resistor in 1% resistors is shown in Table 6-1. The MODE pin setting can be reset only by a VIN or EN power cycling.

**Table 6-1. MODE Pin Settings**

MODE Pin	Switching Frequency	Over Current Limit
R = 10kohm	500kHz	ILIM-1 (Typ = 7.2A)
R = 30.1kohm		ILIM (Typ = 9.6A)
R = 102kohm	800kHz	ILMI-1 (Typ = 7.2A)
R = 162kohm		ILIM (Typ = 9.6A)
R = 249kohm	1200kHz	ILMI-1 (Typ = 7.2A)
R = 374kohm		ILIM (Typ = 9.6A)

Figure 6-1 shows the typical start-up sequence of the device once the enable signal triggers the EN turn-on threshold. After the voltage of internal VCC crosses the UVLO rising threshold, the MODE setting is read. After this process, the MODE is latched and does not change until VIN or EN toggles to restart-up this device. Then after a delay, the internal soft-start function begins to ramp up and Vout ramps up smoothly. When Vout is up to the reference voltage, PGOOD turns to high after a delay.

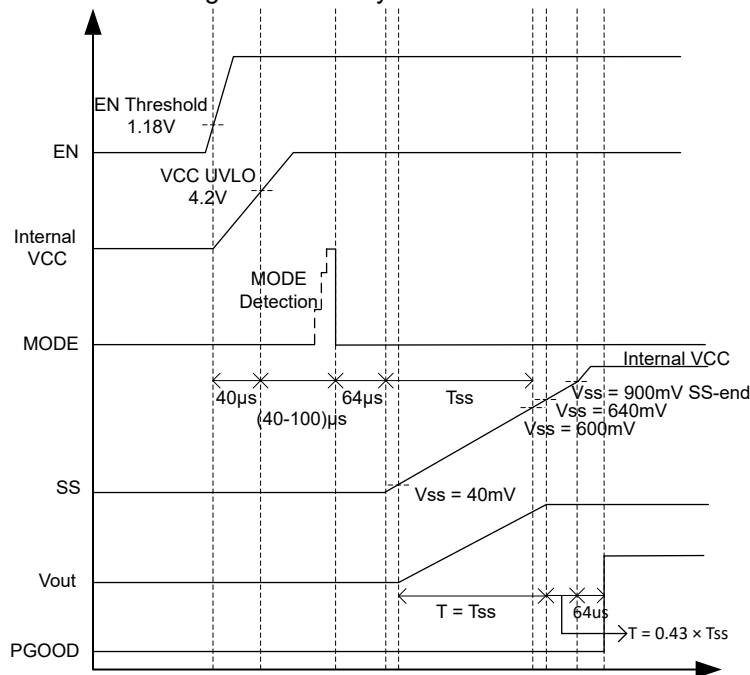

**Figure 6-1. Power-Up Sequence**

### 6.3.3 Soft Start and Pre-Biased Soft Start

The TPS5683x has an adjustable soft-start time that can be set by connecting a capacitor between SS and AGND. Leaving the SS pin floating is set to default internal soft start time 1.8ms. When the EN pin becomes high, the soft-start charge current (I<sub>SS</sub>) begins charging the external capacitor (C<sub>SS</sub>) connected between SS and AGND. The device tracks the lower of the internal soft-start voltage or the external soft-start voltage as the reference. The equation for the soft-start time (T<sub>SS</sub>) is shown in Equation 1.

$$T_{SS} = \frac{C_{SS} \times V_{REF}}{I_{SS}} \quad (1)$$

If the external capacitor (C<sub>SS</sub>) has pre-stored voltage at start-up, the device initially discharge the external capacitor voltage to lower voltage then charge again to prevent inrush start-up.

If the output capacitor is pre-biased at start-up, the device initiates switching and starts ramping up only after the internal reference voltage becomes greater than the feedback voltage  $V_{FB}$ . This scheme make sure that the converters ramp up smoothly into regulation point.

### 6.3.4 Enable and Adjusting Undervoltage Lockout

The EN pin provides electrical on and off control of the device. When the EN pin voltage exceeds the threshold voltage, the device begins operating. If the EN pin voltage is pulled below the threshold voltage, the regulator stops switching and enters the [standby operation](#).

The EN pin has an internal pullup current source which allows the user to float the EN pin to enable the device. If an application requires control of the EN pin, open-drain or open-collector output logic can be used to interface with the pin.

The TPS5683x implements internal undervoltage lockout (UVLO) circuitry on the  $V_{IN}$  pin. The device is disabled when the  $V_{IN}$  pin voltage falls below the internal  $V_{IN}$  UVLO threshold. The internal  $V_{IN}$  UVLO threshold has a hysteresis of 500mV.

If an application requires a higher UVLO threshold on the  $V_{IN}$  pin, then the EN pin can be configured as shown in [Figure 6-2](#). When using the external UVLO function, TI recommends setting the hysteresis at a value greater than 500mV.

The EN pin has a small pullup current,  $I_p$ , which sets the default state of the pin to enable when no external components are connected. The pullup current is also used to control the voltage hysteresis for the UVLO function because it increases by  $I_h$  when the EN pin crosses the enable threshold. Use [Equation 2](#), and [Equation 3](#) to calculate the values of R1 and R2 for a specified UVLO threshold. After R1, R2 settle down, the  $V_{EN}$  voltage can be calculated by [Equation 4](#), which must be lower than 5.5V with maximum  $V_{EN}$ .

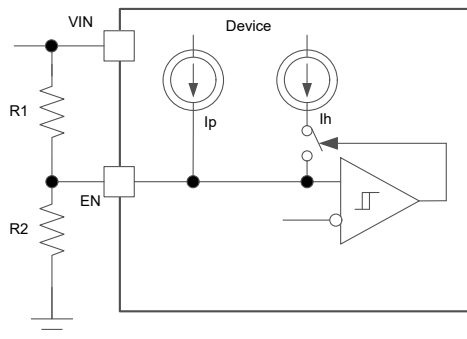

**Figure 6-2. Adjustable  $V_{IN}$  Undervoltage Lockout**

$$R_1 = \frac{V_{START} \times \frac{V_{ENfalling}}{V_{ENrising}} - V_{STOP}}{I_p \times \left(1 - \frac{V_{ENfalling}}{V_{ENrising}}\right) + I_h} \quad (2)$$

$$R_2 = \frac{R_1 \times V_{ENfalling}}{V_{STOP} - V_{ENfalling} + R_1 \times (I_p + I_h)} \quad (3)$$

$$V_{EN} = \frac{R_2 \times V_{IN} + R_1 \times R_2 \times (I_p + I_h)}{R_1 + R_2} \quad (4)$$

Where

- $I_p = 1\mu A$
- $I_h = 3\mu A$
- $V_{ENfalling} = 1.07V$
- $V_{ENrising} = 1.18V$

### 6.3.5 Output Overcurrent Limit and Undervoltage Protection

The output overcurrent protection (OCP) is implemented using a cycle-by-cycle low-side MOSFET valley current detection and high-side MOSFET peak current detection. The switching current is monitored by measuring the MOSFET drain to source voltage. This voltage is proportional to the switching current. To improve accuracy, the voltage sensing is temperature compensated.

There are some important considerations for this type of overcurrent limit. When the load current is higher than the  $I_{LS\_OCL}$  added by one half of the peak-to-peak inductor ripple current, or higher than  $I_{HS\_OCL}$  subtracted by one half of the peak-to-peak inductor ripple current, the OCP is triggered and the current is being limited. Output voltage tends to drop because the load demand is higher than what the converter can support. When the output voltage falls below 65% of the target voltage, the UVP comparator detects it and shuts down the device after a deglitch wait time of 256 $\mu$ s and then re-start after the hiccup time of 10.5 cycles of soft-start time. When the overcurrent condition is removed, the output recovers.

### 6.3.6 Overvoltage Protection

The TPS5683x has the overvoltage protection feature. When the output voltage becomes higher than 125% of the target voltage, the OVP is triggered. The output discharges after a deglitch time of 32 $\mu$ s and both the high-side MOSFET driver and the low-side MOSFET driver turn off. When the overvoltage condition is removed, the output voltage recovers.

### 6.3.7 UVLO Protection

Undervoltage Lockout protection(UVLO) monitors the internal regulator voltage. When the voltage is lower than UVLO threshold voltage, the device is shut down. This protection is non-latched.

### 6.3.8 Thermal Shutdown

The junction temperature ( $T_J$ ) of the device is monitored by an internal temperature sensor. If  $T_J$  exceeds 165°C (typical), the device goes into thermal shutdown. Both the high-side and low-side power FETs are turned off and the discharge path is turned on. When  $T_J$  decreases below the hysteresis amount, the converter resumes normal operation, beginning with soft start. To avoid unstable conditions, a hysteresis of typically 30°C is implemented on the thermal shutdown temperature.

### 6.3.9 Output Voltage Discharge

The TPS5683x has a built in discharge function by using an integrated MOSFET with 200 $\Omega$   $R_{DS(on)}$ , which is connected to the output terminal SW. The discharge is slow due to the lower current capability of the MOSFET. The discharge path turns on when the device is turned off due to UV, OV, OT, and EN shutdown conditions.

### 6.3.10 Power Good

The TPS5683x has a built in power-good (PG) function to indicate whether the output voltage has reached the appropriate level or not. The PG signal can be used for start-up sequencing of multiple rails. The PG pin is an open-drain output that requires a pullup resistor (to any voltage below 5.5V). TI recommends a pullup resistor of 100k $\Omega$  to pull the PG pin up to 5V voltage. The PG pin can sink 10mA of current and maintain the specified logic low level. After the FB pin voltage is between 90% and 110% of the internal reference voltage ( $V_{REF}$ ) and after a deglitch time of 64 $\mu$ s, the PG turns to high impedance status. The PG pin is pulled low after a deglitch time of 32 $\mu$ s when FB pin voltage is lower than 85% of the internal reference voltage or greater than 115% of the internal reference voltage, or in events of EN shutdown, UVLO conditions, and thermal shutdown.  $V_{IN}$  must remain present for the PG pin to stay low as shown in [Table 6-2](#).

**Table 6-2. Power-Good Pin Logic Table**

Device State		PG Logic Status	
		High Impedance	Low
Enable (EN=High)	$90\% \times V_{REF} \leq V_{FB} \leq 110\% \times V_{REF}$	√	
	$V_{FB} < 85\% \times V_{REF}$ or $V_{FB} > 115\% \times V_{REF}$		√
Shutdown (EN=Low)			√
UVLO	$2V < V_{IN} < V_{UVLO}$		√
Thermal shutdown	$T_J > T_{SD}$		√
Power supply removal	$V_{IN} < 2V$	√	

### 6.3.11 Large Duty Operation

The TPS5683x can support large duty operations by smoothly dropping down the switching frequency. The switching frequency is allowed to smoothly drop when duty cycle is higher than 62% to make  $T_{ON}$  extended to implement the large duty operation and also improve the performance of the load transient. The TPS5683x can support up to 98% duty cycle operation.

## 6.4 Device Functional Modes

### 6.4.1 Standby Operation

The TPS5683x can be placed in standby mode by pulling the EN pin low. The device operates with a shutdown current of 3μA (typical) when in standby condition.

### 6.4.2 Eco-mode

TPS56837 is set to Eco-mode to maintain high light load efficiency. As the output current decreases from heavy load condition, the inductor current is also reduced and eventually comes to a point that the rippled valley touches zero level, which is the boundary between continuous conduction and discontinuous conduction modes. The rectifying MOSFET is turned off when the zero inductor current is detected. As the load current further decreases the converter runs into discontinuous conduction mode. The on-time is kept almost the same as in the continuous conduction mode so that longer time is needed to discharge the output capacitor with smaller load current to the level of the reference voltage. This process makes the switching frequency lower, proportional to the load current, and keeps the light load efficiency high. The transition point to the light load operation  $I_{OUT(LL)}$  current can be calculated by [Equation 5](#).

$$I_{OUT(LL)} = \frac{1}{2 \times L \times F_{sw}} \times \frac{(V_{IN} - V_{OUT}) \times V_{OUT}}{V_{IN}} \quad (5)$$

### 6.4.3 Forced Continuous Conduction Mode

The TPS56838 is designed to operate in forced continuous conduction mode (FCCM) under light load conditions. During FCCM, the switching frequency is maintained at a constant level over the entire load range, which is designed for applications requiring tight control of the switching frequency and output voltage ripple at the cost of lower efficiency under light load. For some audio applications, this mode can help avoid switching frequency drop into audible range that can introduce some noise.

### 6.4.4 Out-of-Audio™ Mode

TPS56836 implements the Out-of-Audio (OOA) mode, which is a unique control feature that keeps the switching frequency above audible frequency (20Hz to 20kHz), even at no load condition. When operating in OOA mode, the minimum switching frequency is clamped above 30kHz which avoids the audible noise in the system. The loading to enter OOA mode depends on output LC filter.



## 7 Application and Implementation

### Note

Information in the following applications sections is not part of the TI component specification, and TI does not warrant its accuracy or completeness. TI's customers are responsible for determining suitability of components for their purposes, as well as validating and testing their design implementation to confirm system functionality.

### 7.1 Application Information

The schematic of [Figure 7-1](#) shows a typical application for TPS56837. This design converts an input voltage range of 5.5V to 28V down to 5V with a maximum output current of 8A.

### 7.2 Typical Application

The application schematic in [Figure 7-1](#) shows the TPS56837 5.5V to 28V input, 5V output converter design meeting the requirements for 8A output. This circuit is available as the evaluation module (EVM). The sections provide the design procedure.

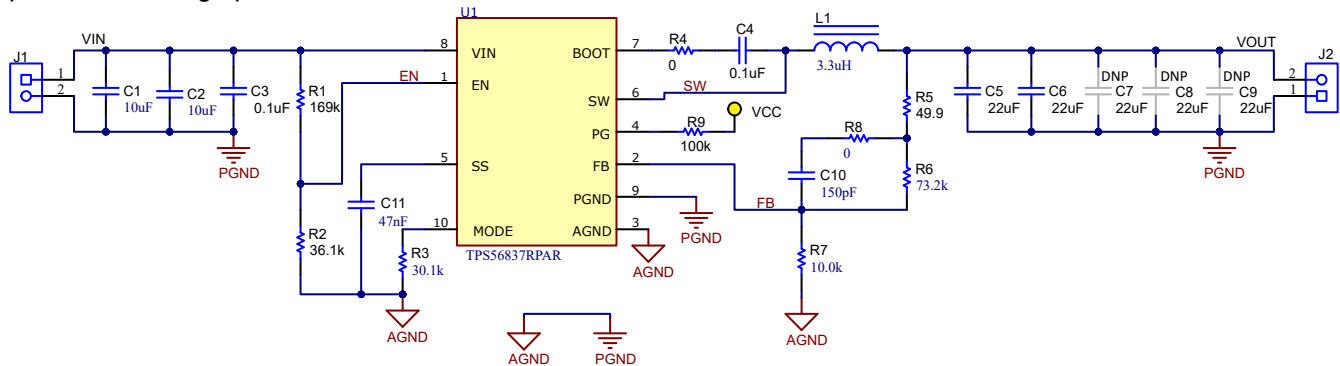

**Figure 7-1. TPS56837 5V, 8A Reference Design**

#### 7.2.1 Design Requirements

[Table 7-1](#) shows the design parameters for this application.

**Table 7-1. Design Parameters**

PARAMETER	EXAMPLE VALUE
Input voltage range	24V nominal, 5.5V to 28V
Output voltage	5V
Transient response, 8A load step	$\Delta V_{OUT} = \pm 5\%$
Output ripple voltage	< 35mV at CCM
Output current rating	8A
Operating frequency	500kHz

## 7.2.2 Detailed Design Procedure

### 7.2.2.1 Custom Design With WEBENCH® Tools

Create a custom design with the TPS5683x using the [WEBENCH® Power Designer](#).

1. Start by entering the input voltage ( $V_{IN}$ ), output voltage ( $V_{OUT}$ ), and output current ( $I_{OUT}$ ) requirements.
2. Optimize the design for key parameters such as efficiency, footprint, and cost using the optimizer dial.
3. Compare the generated design with other possible solutions from Texas Instruments.

The WEBENCH Power Designer provides a customized schematic along with a list of materials with real-time pricing and component availability.

In most cases, these actions are available:

- Run electrical simulations to see important waveforms and circuit performance
- Run thermal simulations to understand board thermal performance
- Export customized schematic and layout into popular CAD formats
- Print PDF reports for the design, and share the design with colleagues

Get more information about WEBENCH tools at [www.ti.com/WEBENCH](http://www.ti.com/WEBENCH).

### 7.2.2.2 Output Voltage Resistors Selection

The output voltage is set with a resistor divider from the output node to the VFB pin. TI recommends to use 1% tolerance or better divider resistors. Start by using [Equation 6](#) to calculate  $V_{OUT}$ . R5 is optional and can be used to measure the control loop frequency response.

To improve efficiency at very light loads, consider using larger value resistors. If the resistance is too high, the device is more susceptible to noise and voltage errors from the VFB input current is more noticeable. Please note that TI does not recommend dynamically adjusting output voltage.

$$V_{OUT} = 0.6 \times \left(1 + \frac{R6}{R7}\right) \quad (6)$$

### 7.2.2.3 Output Filter Selection

The LC filter used as the output filter has double pole at:

$$f_p = \frac{1}{2\pi \times \sqrt{L_{OUT} \times C_{OUT}}} \quad (7)$$

At low frequencies, the overall loop gain is set by the output set-point resistor divider network and the internal gain of the device. The low frequency phase is 180 degrees. At the output filter pole frequency, the gain rolls off at a  $-40\text{dB}$  per decade rate and the phase drops rapidly. D-CAP3 control mode introduces a high frequency zero that reduces the gain roll off to  $-20\text{dB}$  per decade and increases the phase to 90 degrees one decade above the zero frequency. The inductor and capacitor for the output filter must be selected so that the double pole of [Equation 7](#) is located below the high frequency zero but close enough that the phase boost provided by the high frequency zero provides adequate phase margin for a stable circuit. To meet this requirement use the values recommended in [Table 7-2](#).

**Table 7-2. Recommended Component Values**

Switching Frequency (kHz)	Output Voltage <sup>(1)</sup> (V)	R6 <sup>(2)</sup> (kΩ)	R7 (kΩ)	L1 (μH)	C <sub>OUT</sub> <sup>(3)</sup>			C10 <sup>(4)</sup> (pF)
					Minimum	Typical	Maximum	
500	1.05	7.5	10	1	22uF × 1	22uF × 3	22uF × 10	
	1.8	20	10	1.5	22uF × 1	22uF × 3	22uF × 10	
	3.3	45.3	10	2.2	22uF × 1	22uF × 3	22uF × 10	100-200 (150 typical)
	5	73.2	10	3.3	22uF × 1	22uF × 2	22uF × 10	100-200 (150 typical)
	9	140	10	4.7	22uF × 1	22uF × 2	22uF × 10	50-150 (100 typical)
	12	383	20	5.6	22uF × 1	22uF × 2	22uF × 10	30-100 (30 typical)
800	1.05	7.5	10	0.68	22uF × 1	22uF × 3	22uF × 10	
	1.8	20	10	1	22uF × 1	22uF × 3	22uF × 10	
	3.3	45.3	10	1.5	22uF × 1	22uF × 3	22uF × 10	100-200 (150 typical)
	5	73.2	10	2.2	22uF × 1	22uF × 2	22uF × 10	100-200 (150 typical)
	9	140	10	3.3	22uF × 1	22uF × 2	22uF × 10	50-150 (100 typical)
	12	383	20	3.3	22uF × 1	22uF × 2	22uF × 10	30-100 (30 typical)
1200	1.05	7.5	10	0.47	22uF × 1	22uF × 3	22uF × 10	
	1.8	20	10	0.68	22uF × 1	22uF × 3	22uF × 10	
	3.3	45.3	10	1	22uF × 1	22uF × 3	22uF × 10	100-200 (150 typical)
	5	73.2	10	1.5	22uF × 1	22uF × 2	22uF × 10	1100-200 (150 typical)
	9	140	10	2.2	22uF × 1	22uF × 2	22uF × 10	50-150 (100 typical)
	12	383	20	2.2	22uF × 1	22uF × 2	22uF × 10	30-100 (30 typical)

(1) Please use the recommended L1 and C<sub>OUT</sub> combination of the higher and closest output rail for unlisted output rails.

(2) R6 = 0Ω for V<sub>OUT</sub> = 0.6V.

(3) C<sub>OUT</sub> in this data sheet is using Murata GRM32ER71E226KE15L 25VDC capacitor. Recommend to use the same effective output capacitance. The effective capacitance is defined as the

actual capacitance under DC bias and temperature, not the rated or nameplate values. All high value ceramic capacitors have a large voltage coefficient in addition to normal tolerances and temperature effects. A careful study of bias and temperature variation of any capacitor bank must be made to make sure that the minimum value of effective capacitance is provided. Refer to the information of DC bias and temperature characteristics from manufacturers of ceramic capacitors. Higher than Cout\_max capacitance is allowed by careful tuning the feedforward compensation.

- (4) R8 and C10 can be used to improve load transient response or improve the loop-phase margin. [Optimizing Transient Response of Internally Compensated DCDC Converters with Feed-forward Capacitor](#) application report is helpful when experimenting with a feed-forward capacitor.

The inductor peak-to-peak ripple current, peak current and RMS current are calculated using [Equation 8](#), [Equation 9](#), and [Equation 10](#). The inductor saturation current rating must be greater than the calculated peak current and the RMS or heating current rating must be greater than the calculated RMS current.

Use 500kHz for  $f_{SW}$ . Make sure the chosen inductor is rated for the peak current of [Equation 9](#) and the RMS current of [Equation 10](#).

$$I_{p-p} = \frac{V_{OUT}}{V_{IN(MAX)}} \times \frac{V_{IN(MAX)} - V_{OUT}}{L_{OUT} \times F_{sw}} \quad (8)$$

$$I_{PEAK} = I_O + \frac{I_{p-p}}{2} \quad (9)$$

$$I_{LO(RMS)} = \sqrt{I_O^2 + \frac{1}{12} \times I_{p-p}^2} \quad (10)$$

For this design example, the calculated peak current is 9.13A and the calculated RMS current is 8.03A. The inductor used is Würth 744325330 with saturation current 15A and rating current 9.7A.

The capacitor value and ESR determines the output voltage ripple. The TPS56837 is intended to use with ceramic or other low ESR capacitors. Use [Equation 11](#) to determine the required RMS current rating for the output capacitor.

$$I_{CO(RMS)} = \frac{V_{OUT} \times (V_{IN} - V_{OUT})}{\sqrt{12} \times V_{IN} \times L_{OUT} \times F_{sw}} \quad (11)$$

For this design, two MuRata GRM32ER71E226KE15L 22 $\mu$ F output capacitors are used so that the effective capacitance is 35 $\mu$ F at DC biased voltage of 5V. The calculated RMS current is 0.63A and each output capacitor is rated for 4A.

#### 7.2.2.4 Input Capacitor Selection

The TPS56837 requires an input decoupling capacitor and a bulk capacitor is needed depending on the application. TI recommends a ceramic capacitor over 10 $\mu$ F for the decoupling capacitor. TI recommends an additional 0.1 $\mu$ F capacitor (C3) from VIN to PGND pin to provide additional high frequency filtering. The capacitor voltage rating must be greater than the maximum input voltage. The input voltage ripple can be calculated using [Equation 12](#).

$$\Delta V_{IN} = \frac{I_{OUTMAX} \times 0.25}{C_{IN} \times F_{sw}} \quad (12)$$

The capacitor must also have a ripple current rating greater than the maximum input current ripple of the application. The input ripple current is calculated by [Equation 13](#):

$$I_{CIN(RMS)} = I_{OUT} \times \sqrt{\frac{V_{OUT}}{V_{IN(MIN)}} \times \frac{V_{IN(MIN)} - V_{OUT}}{V_{IN(MIN)}}} \quad (13)$$

### 7.2.2.5 Bootstrap Capacitor Selection

A 0.1µF ceramic capacitor (C4) must be connected between the BOOT to SW pin for proper operation. TI recommends to use a ceramic capacitor with X5R or better grade dielectric. The capacitor must have a 10V or higher voltage rating.

### 7.2.3 Application Curves

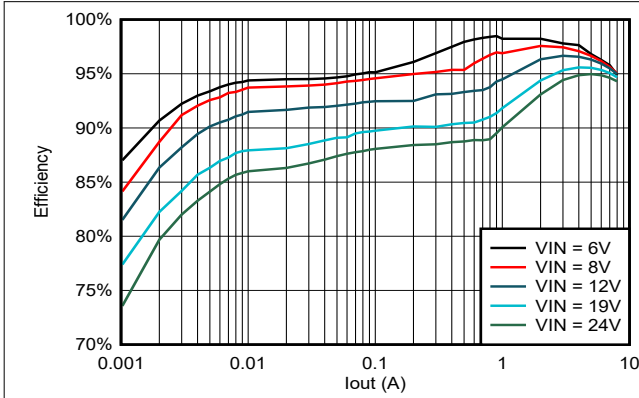

Figure 7-2. Efficiency

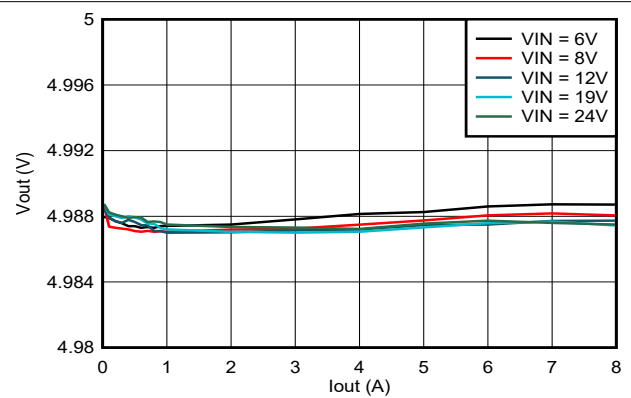

Figure 7-3. Load Regulation

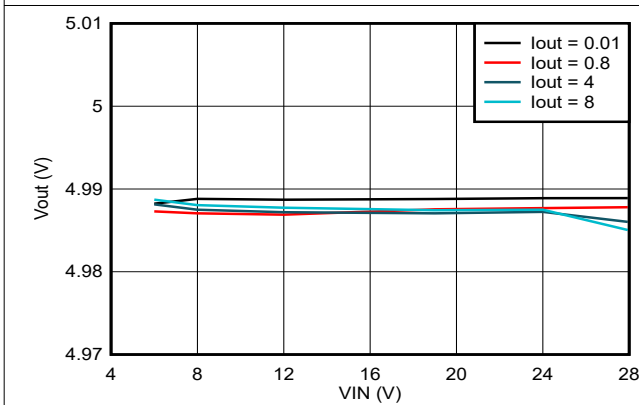

Figure 7-4. Line Regulation

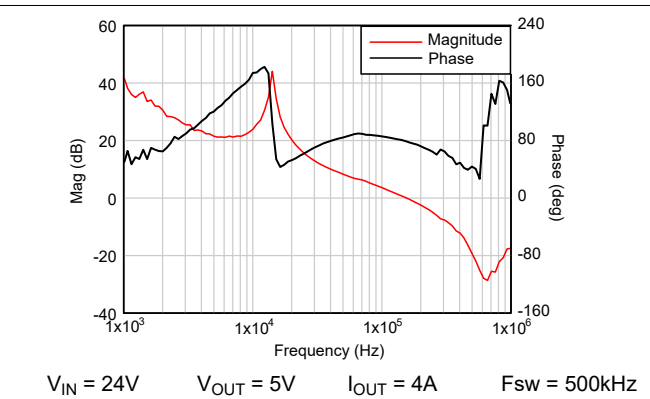

Figure 7-5. Bode Plot

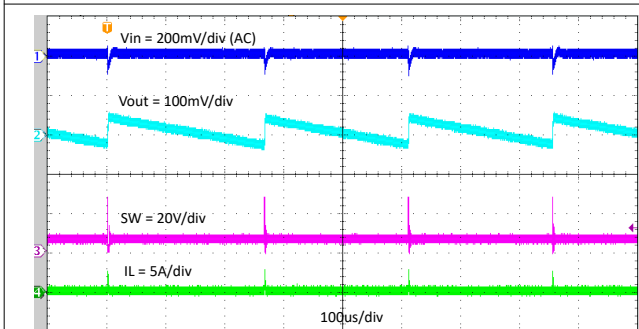

Figure 7-6. Steady State Waveforms, IOUT = 0.01A

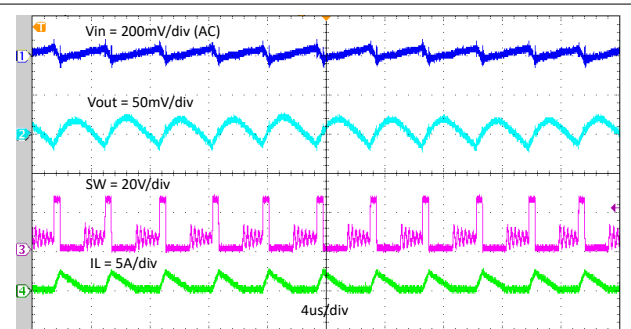
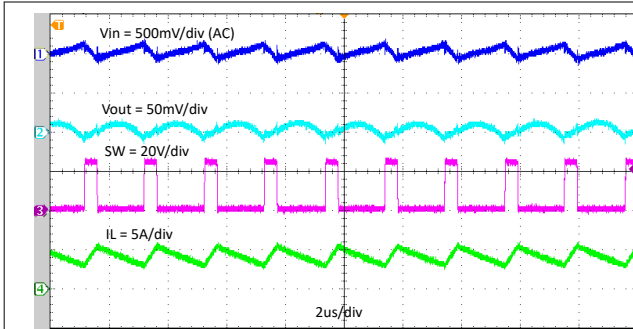
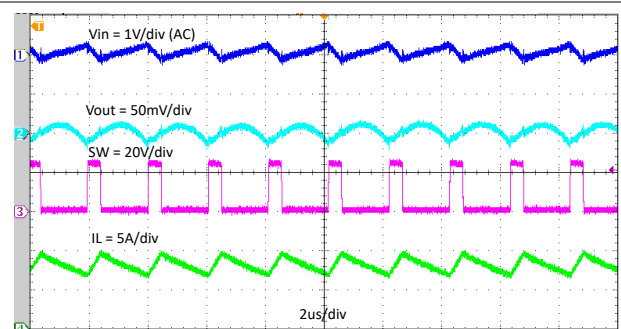

Figure 7-7. Steady State Waveforms, IOUT = 0.6A



**Figure 7-8. Steady State Waveforms,  $I_{OUT} = 4A$**



**Figure 7-9. Steady State Waveforms,  $I_{OUT} = 8A$**

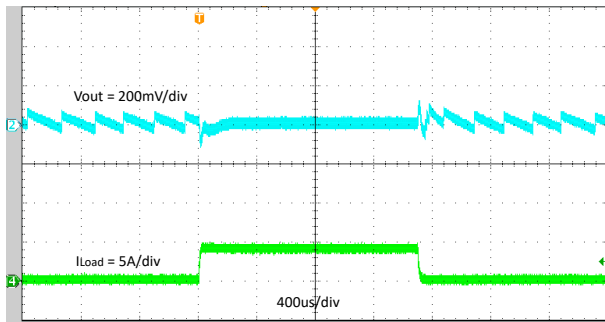

**Figure 7-10. Transient Response 0A to 4A**

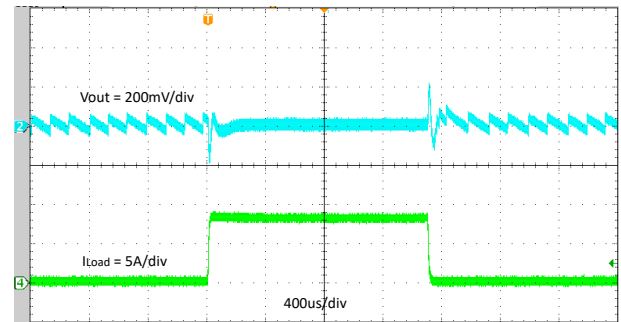

**Figure 7-11. Transient Response 0A to 8A**

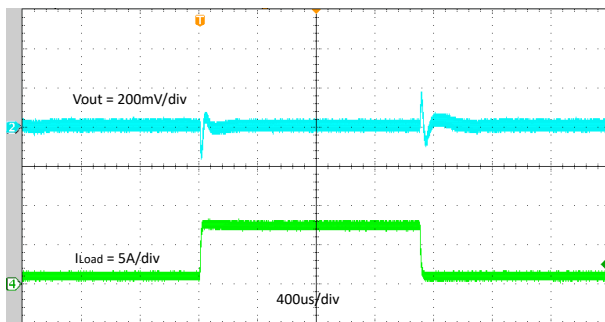

**Figure 7-12. Transient Response 0.8A to 7.2A**

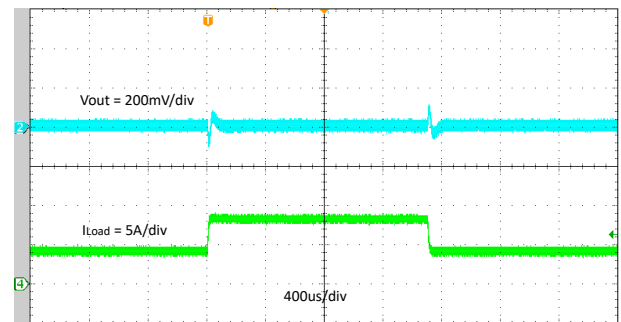

**Figure 7-13. Transient Response 4A to 8A**

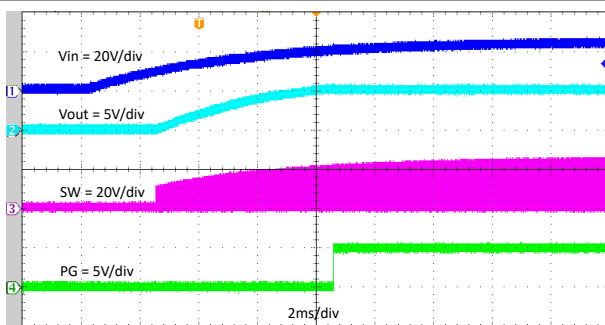

**Figure 7-14. Start-Up Relative to  $V_{IN}$**

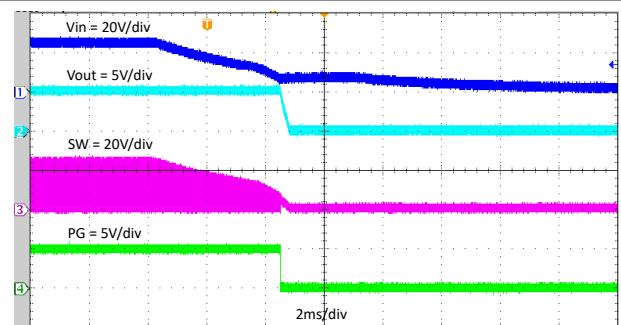

**Figure 7-15. Shutdown Relative to  $V_{IN}$**

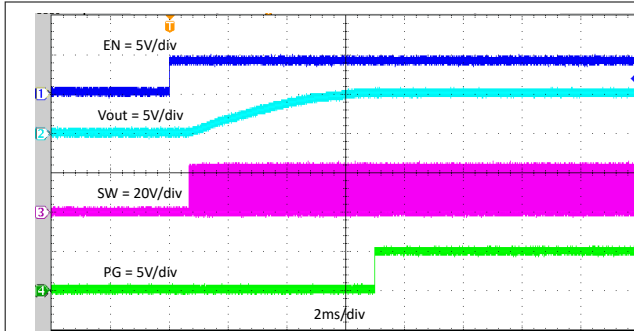

**Figure 7-16. Enable Relative to EN**

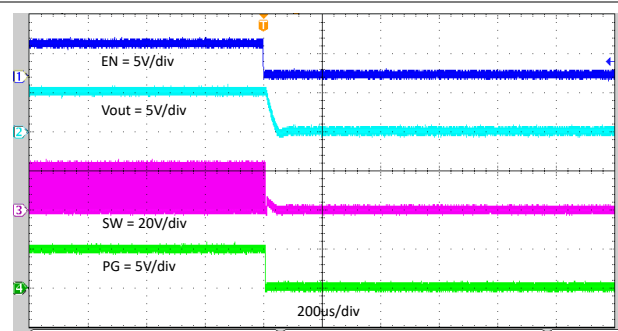

**Figure 7-17. Disable Relative to EN**

## 7.3 Power Supply Recommendations

The TPS56837 is designed to operate from input supply voltage in the range of 4.5V to 28V. Buck converters require the input voltage to be higher than the output voltage for proper operation. Input supply current must be appropriate for the desired output current. If the input voltage supply is located far from the TPS56837 circuit, TI recommends some additional input bulk capacitance.

## 7.4 Layout

### 7.4.1 Layout Guidelines

1. Use a four-layer PCB with maximum ground plane partitioning possible for good thermal performance. A 76mm × 76mm, four-layer PCB with 2-1-1-2 oz copper is used as example.
2. Make VIN and PGND traces as wide as possible to reduce trace impedance. The wide areas are also of advantage from the view point of heat dissipation.
3. Put at least two vias for PGND pad for better thermal performance.
4. Place the input capacitor and output capacitor as close to the device as possible to minimize trace impedance.
5. Provide sufficient vias for the input capacitor and output capacitor.
6. Keep the SW trace as physically short and wide as practical to minimize radiated emissions.
7. Do not allow switching current to flow under the device.
8. Keep the SS trace as far as possible to SW trace to minimize coupling during soft start.
9. Connect a separate VOUT path to the upper feedback resistor.
10. Keep the voltage feedback loop away from the high-voltage switching trace, and preferably has ground shield.
11. Make the trace of the VFB node as small as possible to avoid noise coupling. Also keep feedback resistors and the feedforward capacitor near the IC.
12. Make the PGND trace between the output capacitor and the PGND pin as wide as possible to minimize the trace impedance.
13. Note that inner layer 1 is PGND and AGND with the single point net tie.
14. Note that inner layer 2 is PGND for better heat dissipation.

### 7.4.2 Layout Example

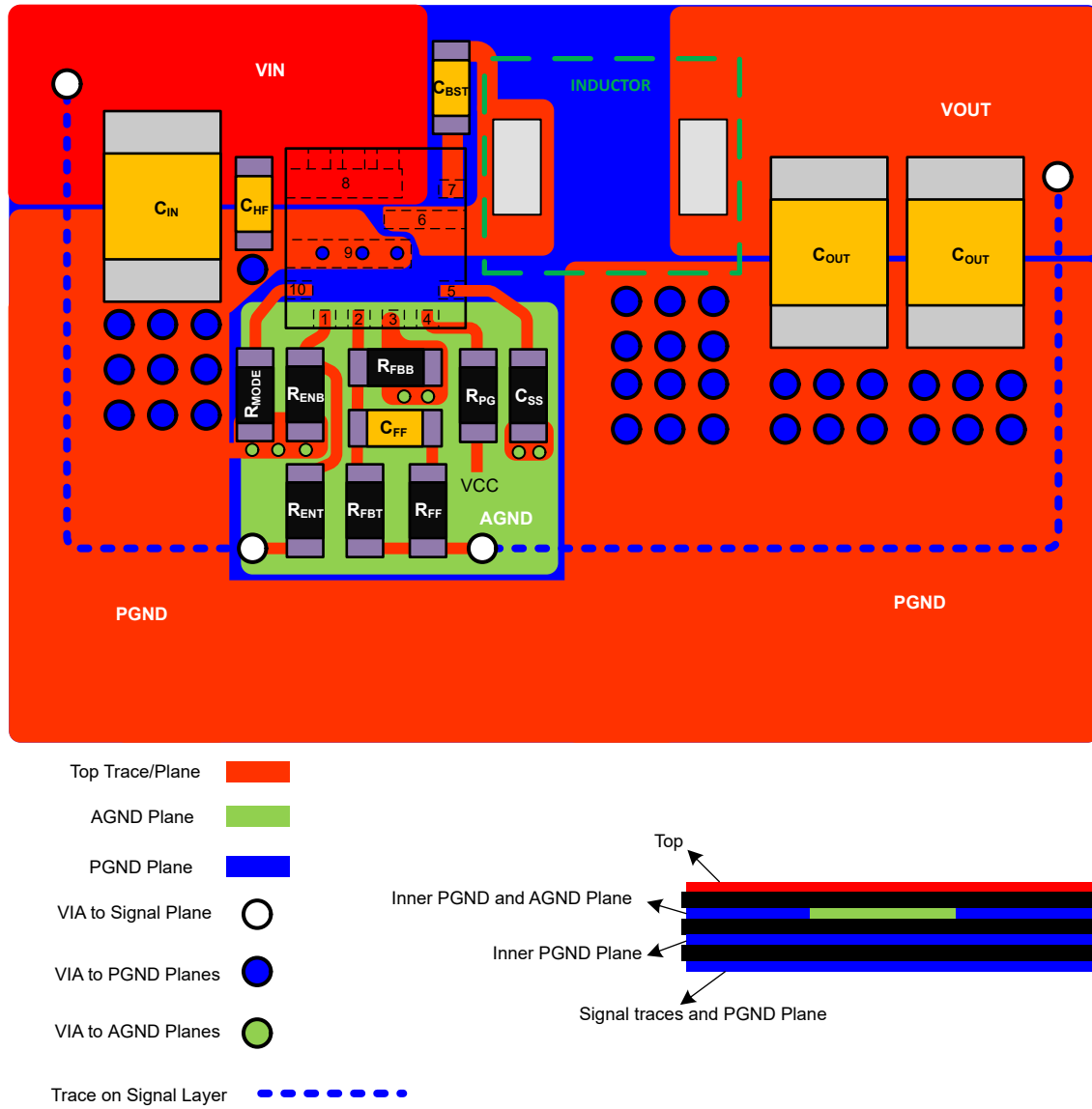



## 8 Device and Documentation Support

### 8.1 Device Support

#### 8.1.1 Development Support

##### 8.1.1.1 Custom Design With WEBENCH® Tools

Create a custom design with the TPS5683x using the [WEBENCH® Power Designer](#).

1. Start by entering the input voltage ( $V_{IN}$ ), output voltage ( $V_{OUT}$ ), and output current ( $I_{OUT}$ ) requirements.
2. Optimize the design for key parameters such as efficiency, footprint, and cost using the optimizer dial.
3. Compare the generated design with other possible solutions from Texas Instruments.

The WEBENCH Power Designer provides a customized schematic along with a list of materials with real-time pricing and component availability.

In most cases, these actions are available:

- Run electrical simulations to see important waveforms and circuit performance
- Run thermal simulations to understand board thermal performance
- Export customized schematic and layout into popular CAD formats
- Print PDF reports for the design, and share the design with colleagues

Get more information about WEBENCH tools at [www.ti.com/WBENCH](http://www.ti.com/WBENCH).

### 8.2 Documentation Support

#### 8.2.1 Related Documentation

For related documentation, see the following:

Texas Instruments, [Optimizing Transient Response of Internally Compensated DCDC Converters with Feed-forward Capacitor](#) application report

### 8.3 Receiving Notification of Documentation Updates

To receive notification of documentation updates, navigate to the device product folder on [ti.com](http://ti.com). Click on *Notifications* to register and receive a weekly digest of any product information that has changed. For change details, review the revision history included in any revised document.

### 8.4 Support Resources

[TI E2E™ support forums](#) are an engineer's go-to source for fast, verified answers and design help — straight from the experts. Search existing answers or ask your own question to get the quick design help you need.

Linked content is provided "AS IS" by the respective contributors. They do not constitute TI specifications and do not necessarily reflect TI's views; see TI's [Terms of Use](#).

### 8.5 Trademarks

D-CAP3™, Out-of-Audio™, HotRod™, and TI E2E™ are trademarks of Texas Instruments.

WEBENCH® is a registered trademark of Texas Instruments.

All trademarks are the property of their respective owners.

### 8.6 Electrostatic Discharge Caution



This integrated circuit can be damaged by ESD. Texas Instruments recommends that all integrated circuits be handled with appropriate precautions. Failure to observe proper handling and installation procedures can cause damage.

ESD damage can range from subtle performance degradation to complete device failure. Precision integrated circuits may be more susceptible to damage because very small parametric changes could cause the device not to meet its published specifications.

### 8.7 Glossary

[TI Glossary](#) This glossary lists and explains terms, acronyms, and definitions.

## 9 Revision History

NOTE: Page numbers for previous revisions may differ from page numbers in the current version.

<b>Changes from Revision A (October 2023) to Revision B (January 2024)</b>	<b>Page</b>
• Added the TPS56838 throughout the document.....	1
• Added the TPS56836 throughout the document.....	1
• Added the WEBENCH Power Designer link for TPS5683x.....	1

<b>Changes from Revision * (March 2023) to Revision A (October 2023)</b>	<b>Page</b>
• Changed document status from Advance Information to Production Data.....	1

## 10 Mechanical, Packaging, and Orderable Information

The following pages include mechanical, packaging, and orderable information. This information is the most current data available for the designated devices. This data is subject to change without notice and revision of this document. For browser-based versions of this data sheet, refer to the left-hand navigation.

**PACKAGING INFORMATION**

Orderable Device	Status (1)	Package Type	Package Drawing	Pins	Package Qty	Eco Plan (2)	Lead finish/ Ball material (6)	MSL Peak Temp (3)	Op Temp (°C)	Device Marking (4/5)	Samples
TPS56836RPAR	ACTIVE	VQFN-HR	RPA	10	5000	RoHS & Green	SN	Level-2-260C-1 YEAR	-40 to 150	T56836	<a href="#">Samples</a>
TPS56837RPAR	ACTIVE	VQFN-HR	RPA	10	3000	RoHS & Green	SN	Level-2-260C-1 YEAR	-40 to 150	T56837	<a href="#">Samples</a>
TPS56838RPAR	ACTIVE	VQFN-HR	RPA	10	5000	RoHS & Green	SN	Level-2-260C-1 YEAR	-40 to 150	T56838	<a href="#">Samples</a>

(1) The marketing status values are defined as follows:

**ACTIVE:** Product device recommended for new designs.

**LIFEBUY:** TI has announced that the device will be discontinued, and a lifetime-buy period is in effect.

**NRND:** Not recommended for new designs. Device is in production to support existing customers, but TI does not recommend using this part in a new design.

**PREVIEW:** Device has been announced but is not in production. Samples may or may not be available.

**OBSOLETE:** TI has discontinued the production of the device.

(2) **RoHS:** TI defines "RoHS" to mean semiconductor products that are compliant with the current EU RoHS requirements for all 10 RoHS substances, including the requirement that RoHS substance do not exceed 0.1% by weight in homogeneous materials. Where designed to be soldered at high temperatures, "RoHS" products are suitable for use in specified lead-free processes. TI may reference these types of products as "Pb-Free".

**RoHS Exempt:** TI defines "RoHS Exempt" to mean products that contain lead but are compliant with EU RoHS pursuant to a specific EU RoHS exemption.

**Green:** TI defines "Green" to mean the content of Chlorine (Cl) and Bromine (Br) based flame retardants meet JS709B low halogen requirements of <=1000ppm threshold. Antimony trioxide based flame retardants must also meet the <=1000ppm threshold requirement.

(3) MSL, Peak Temp. - The Moisture Sensitivity Level rating according to the JEDEC industry standard classifications, and peak solder temperature.

(4) There may be additional marking, which relates to the logo, the lot trace code information, or the environmental category on the device.

(5) Multiple Device Markings will be inside parentheses. Only one Device Marking contained in parentheses and separated by a "~" will appear on a device. If a line is indented then it is a continuation of the previous line and the two combined represent the entire Device Marking for that device.

(6) Lead finish/Ball material - Orderable Devices may have multiple material finish options. Finish options are separated by a vertical ruled line. Lead finish/Ball material values may wrap to two lines if the finish value exceeds the maximum column width.

**Important Information and Disclaimer:**The information provided on this page represents TI's knowledge and belief as of the date that it is provided. TI bases its knowledge and belief on information provided by third parties, and makes no representation or warranty as to the accuracy of such information. Efforts are underway to better integrate information from third parties. TI has taken and continues to take reasonable steps to provide representative and accurate information but may not have conducted destructive testing or chemical analysis on incoming materials and chemicals. TI and TI suppliers consider certain information to be proprietary, and thus CAS numbers and other limited information may not be available for release.

In no event shall TI's liability arising out of such information exceed the total purchase price of the TI part(s) at issue in this document sold by TI to Customer on an annual basis.

**TAPE AND REEL INFORMATION**

**QUADRANT ASSIGNMENTS FOR PIN 1 ORIENTATION IN TAPE**



\*All dimensions are nominal

Device	Package Type	Package Drawing	Pins	SPQ	Reel Diameter (mm)	Reel Width W1 (mm)	A0 (mm)	B0 (mm)	K0 (mm)	P1 (mm)	W (mm)	Pin1 Quadrant
TPS56836RPAR	VQFN-HR	RPA	10	5000	330.0	12.4	3.3	3.3	1.1	8.0	12.0	Q2
TPS56837RPAR	VQFN-HR	RPA	10	3000	330.0	12.4	3.3	3.3	1.1	8.0	12.0	Q2
TPS56838RPAR	VQFN-HR	RPA	10	5000	330.0	12.4	3.3	3.3	1.1	8.0	12.0	Q2

**TAPE AND REEL BOX DIMENSIONS**

\*All dimensions are nominal

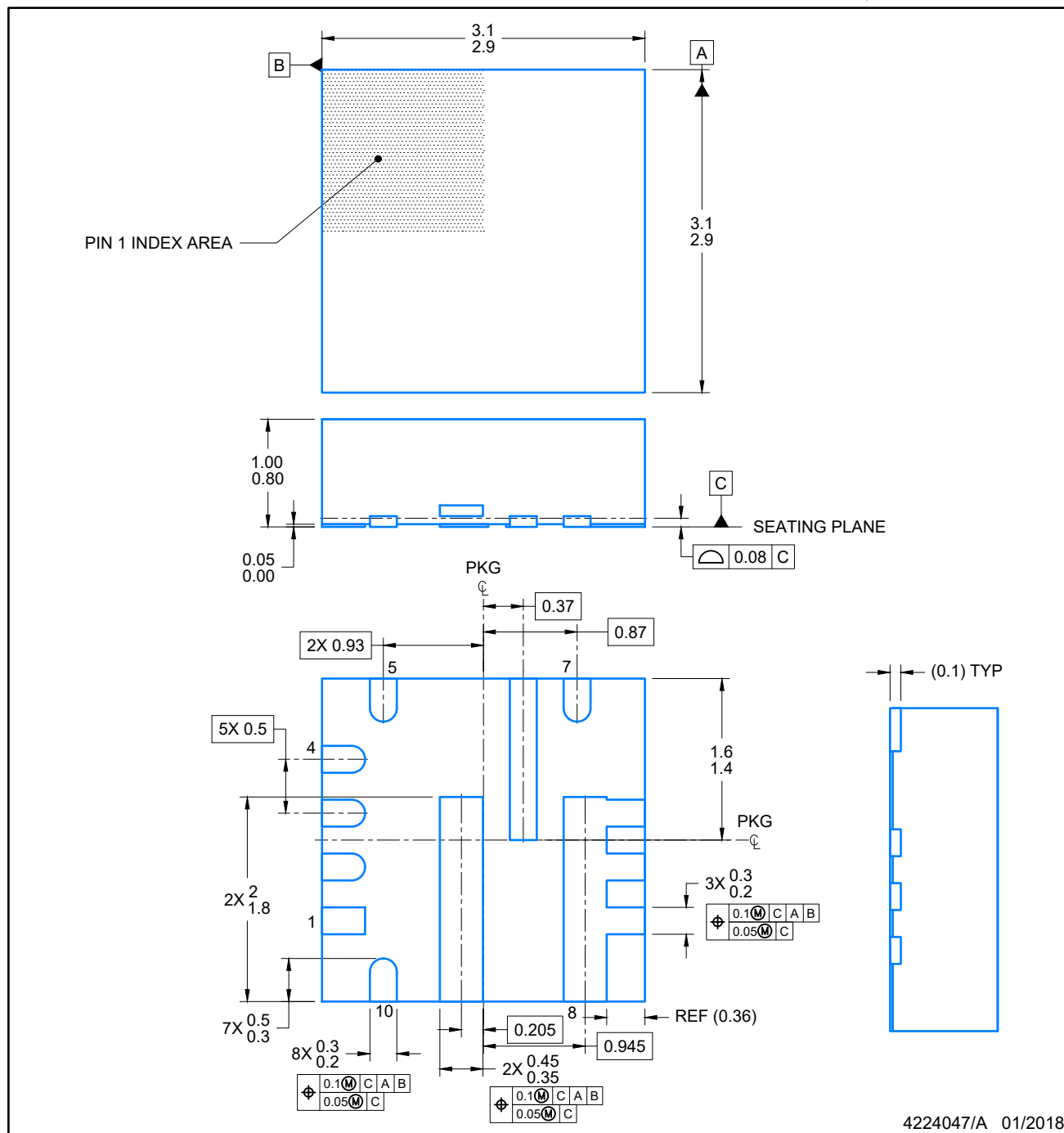
Device	Package Type	Package Drawing	Pins	SPQ	Length (mm)	Width (mm)	Height (mm)
TPS56836RPAR	VQFN-HR	RPA	10	5000	367.0	367.0	35.0
TPS56837RPAR	VQFN-HR	RPA	10	3000	367.0	367.0	35.0
TPS56838RPAR	VQFN-HR	RPA	10	5000	367.0	367.0	35.0



4224047/A 01/2018

NOTES:

1. All linear dimensions are in millimeters. Any dimensions in parenthesis are for reference only. Dimensioning and tolerancing per ASME Y14.5M.
2. This drawing is subject to change without notice.

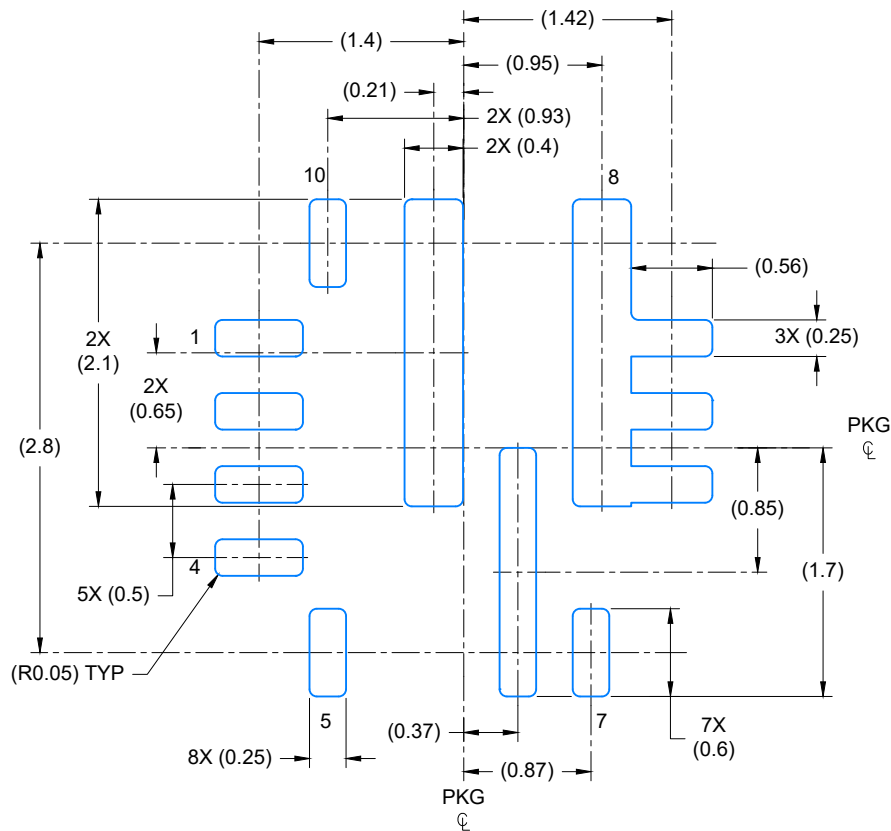

LAND PATTERN EXAMPLE  
EXPOSED METAL SHOWN  
SCALE: 20X

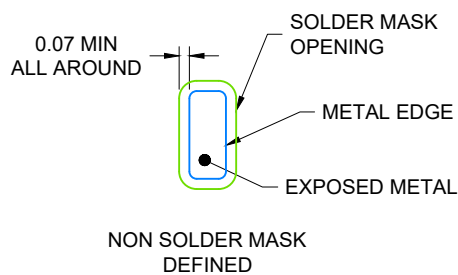

4224047/A 01/2018

NOTES: (continued)

3. For more information, see Texas Instruments literature number SLUA271 ([www.ti.com/lit/sluea271](http://www.ti.com/lit/sluea271)).
4. Solder mask tolerances between and around signal pads can vary based on board fabrication site.



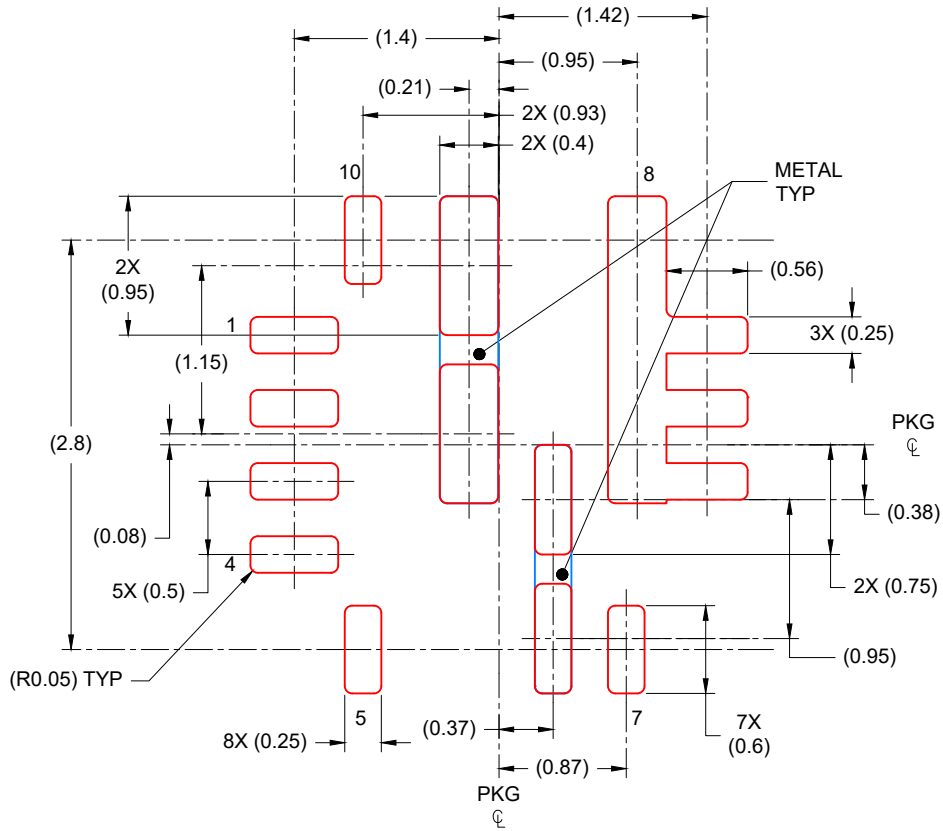

SOLDER PASTE EXAMPLE  
 BASED ON 0.1 mm THICK STENCIL  
 EXPOSED PAD  
 PADS 6 and 9: 89% PRINTED COVERAGE BY  
 AREA  
 SCALE: 20X

4224047/A 01/2018

NOTES: (continued)

5. Laser cutting apertures with trapezoidal walls and rounded corners may offer better paste release. IPC-7525 may have alternate design recommendations.

## IMPORTANT NOTICE AND DISCLAIMER

TI PROVIDES TECHNICAL AND RELIABILITY DATA (INCLUDING DATA SHEETS), DESIGN RESOURCES (INCLUDING REFERENCE DESIGNS), APPLICATION OR OTHER DESIGN ADVICE, WEB TOOLS, SAFETY INFORMATION, AND OTHER RESOURCES "AS IS" AND WITH ALL FAULTS, AND DISCLAIMS ALL WARRANTIES, EXPRESS AND IMPLIED, INCLUDING WITHOUT LIMITATION ANY IMPLIED WARRANTIES OF MERCHANTABILITY, FITNESS FOR A PARTICULAR PURPOSE OR NON-INFRINGEMENT OF THIRD PARTY INTELLECTUAL PROPERTY RIGHTS.

These resources are intended for skilled developers designing with TI products. You are solely responsible for (1) selecting the appropriate TI products for your application, (2) designing, validating and testing your application, and (3) ensuring your application meets applicable standards, and any other safety, security, regulatory or other requirements.

These resources are subject to change without notice. TI grants you permission to use these resources only for development of an application that uses the TI products described in the resource. Other reproduction and display of these resources is prohibited. No license is granted to any other TI intellectual property right or to any third party intellectual property right. TI disclaims responsibility for, and you will fully indemnify TI and its representatives against, any claims, damages, costs, losses, and liabilities arising out of your use of these resources.

TI's products are provided subject to [TI's Terms of Sale](#) or other applicable terms available either on [ti.com](https://www.ti.com) or provided in conjunction with such TI products. TI's provision of these resources does not expand or otherwise alter TI's applicable warranties or warranty disclaimers for TI products.

TI objects to and rejects any additional or different terms you may have proposed.

Mailing Address: Texas Instruments, Post Office Box 655303, Dallas, Texas 75265  
Copyright © 2024, Texas Instruments Incorporated