

MRD2EVM Microreader Evaluation Kit

User's Guide



Literature Number: SCBU050A
August 2012—Revised December 2012

1	Microreader Overview	4
2	Kit Contents	5
3	Download the Software	6
4	Installation	6
	4.1 Driver Installation	6
	4.2 RI-STU-MRD2 Demo Software (GUI) Installation	9
5	RI-STU-MRD2 Demo Software (GUI) Introduction	9
6	Demo Examples	10
	6.1 Demo 1: Read or Write LF Transponder (Read Only/ Read Write) – Tab 1	10
	6.2 Demo 2: Read or Write LF Transponder (MPT 16/17) – Tab 1	11
	6.3 Demo 3: HDX+ Transponder (Read or Write Memory) – Tab 1	12
	6.4 Demo 4: OTP Transponder (Read or Write ID) – Tab 2	13
	6.5 Demo 5: HDX+ Transponder (Read or Write ID) – Tab 2	14
	6.6 Demo 6: HDX+ Transponder (Trim Frequency) – Tab 2	15
	6.7 Demo 7: HDX+ Transponders (Inventory Command) – Tab 3	16
	6.8 Demo 8: PaLFI (Read, Write, Battery Charge and Check, and Flash LED) – Tab 4	17
7	Schematics	18
	7.1 RI-STU-MRD2 EVM Board	18
	Revision History	19

List of Figures

1	RI-STU-MRD2 EVM Board	4
2	MRD2EVM Carton Box With Contents	5
3	Windows Security	6
4	Driver Installed Successfully	6
5	New Hardware Wizard, Step 1	7
6	New Hardware Wizard, Step 2	7
7	New Hardware Wizard, Step 3	8
8	New Hardware Wizard, Step 4	8
9	RI-STU-MRD2 Demo Software (GUI): Startup Screen	9
10	Read or Write LF Transponder (Type: Read-Only or Read/Write).....	10
11	Read or Write LF Transponder (Type: MPT 16/17).....	11
12	Read or Write Memory Content of HDX+ Transponder	12
13	Read or Write ID of OTP Transponder	13
14	Read or Write ID of HDX+ Transponder	14
15	Trim Resonance Frequency of HDX+ Transponder	15
16	Read Inventory of HDX+ Transponder	16
17	Read, Write, Battery Charge, Battery Check, and Flash LED of PaLFI.....	17
18	RI-STU-MRD2 EVM Board Schematic	18

List of Tables

1	Kit Contents.....	5
2	GUI Tabs.....	9

MRD2EVM Microreader Evaluation Kit

WARNING

The terminals across the antenna connectors SJ1 and SJ2, the through-hole contact below mark R6-->R7, and the through-hole contacts 16 and 19 of CON3 operate at potentially hazardous voltages. Effective safety application procedures and knowledge are required to minimize risk of electrical shock hazard when using this EVM. The user should be technically qualified to operate this EVM, including having full knowledge of risks associated in working with electrically live and hazardous voltages commonly found in development platforms. Careful review of *General Texas Instruments High Voltage Evaluation Module (TI HV EVM) User Safety Guidelines* at the end of this document is required prior to using this EVM.

1 Microreader Overview

The microreader evaluation board (RI-STU-MRD2) is a complete USB-based reader module providing the hardware and software to communicate with TI's low-frequency (LF), half-duplex (HDX), and advanced transponders for programming and tuning after the production phase.

The USB reader-writer stick contains the RI-STU-MRD2 DIL module, which is mounted on an antenna base board with a USB connector. The RI-STU-MRD2 is backward compatible with the RS232 based RI-STU-MRD1 reader module.

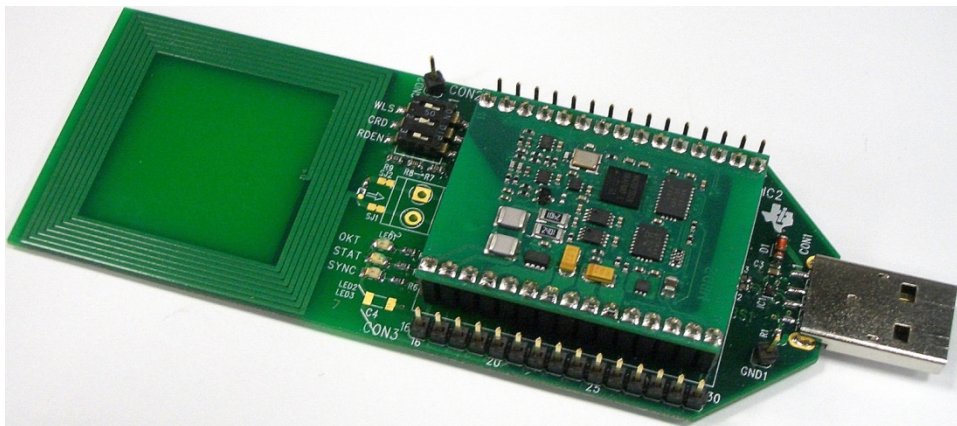

Figure 1. RI-STU-MRD2 EVM Board

The main features of the RI-STU-MRD2 are:

- RS232 and USB interfaces
- Multi-purpose I/Os
- Low-power operation (2.7 V to 5.5 V)
- Supports programming and tuning of advanced transponders
- Easy to design in and use

2 Kit Contents

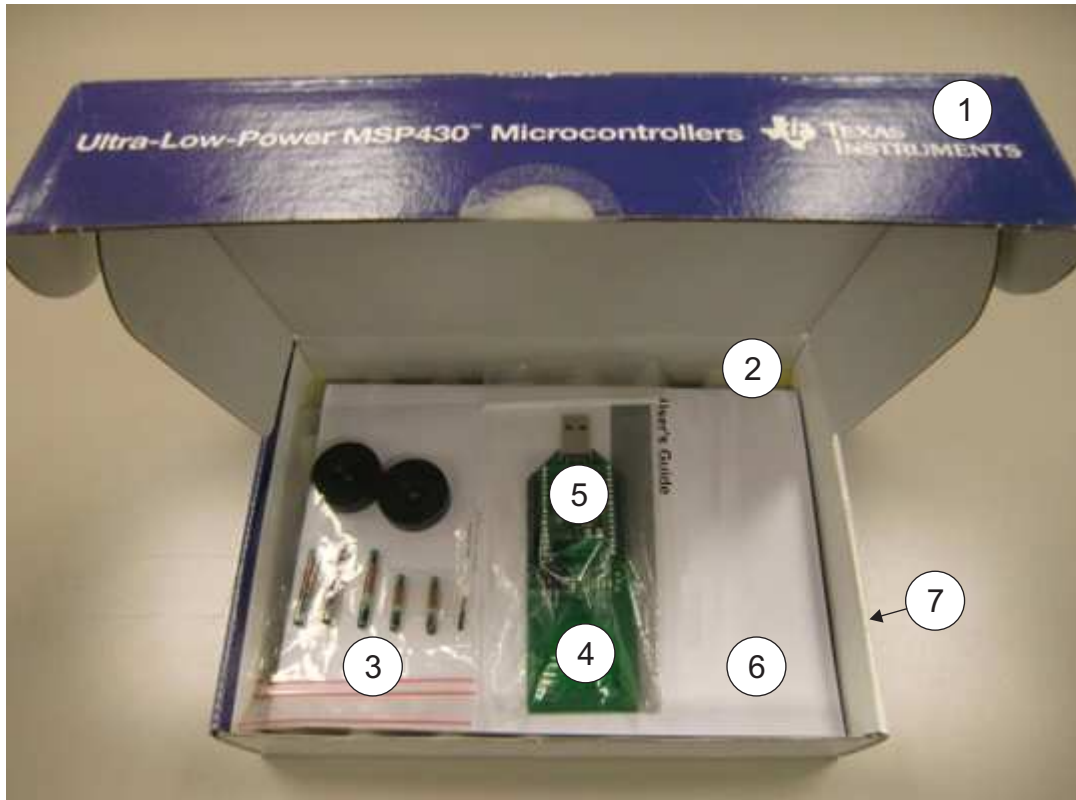

Figure 2. MRD2EVM Carton Box With Contents

Table 1. Kit Contents

Pos	Ref Des	Part Type	Order or Specification Number
1	Box	Carton Box MSP430	
2	Foam	Foam Protection	
3	Samples	Samples	RI-TRP-DR2B-30 RI-TRP-RR2B-30 RI-TRP-WR2B-30 RI-TRP-RR3P-30 RI-TRP-WR3P-30 TRPGR30TGC RI-TRP-R9QL-30
4	Carrier Board		PCB MRD2EVM V2.0
5	Microreader		RI-STU-MRD2
6	Manual		SCBU50
7	Label		

3 Download the Software

Download the latest version of the following files:

1. RI-STU-MRD2 reference manual: [SCBU049](#)
2. RI-STU-MRD2 demo software (GUI): [SCBC010](#)
3. USB device driver: [SCBC010](#)
4. Additional documents, such as application reports and white papers: <http://www.ti.com/rfid>
5. RI-STU-MRD2 product folder: <http://www.ti.com/product/ri-stu-mrd2>

4 Installation

4.1 Driver Installation

1. Download the driver from the link specified in 3. Download the software.
2. Proceed according to the type of Operating system.

4.1.1 Windows 7 or Later

1. Remove the RI-STU-MRD2 EVM board if it is already connected to USB Port.
2. Right click on the driver file and click INSTALL.
3. Click YES if Windows prompts for authentication from User Account Control.
4. Click "Install this driver software anyway", if Windows prompts for authentication.

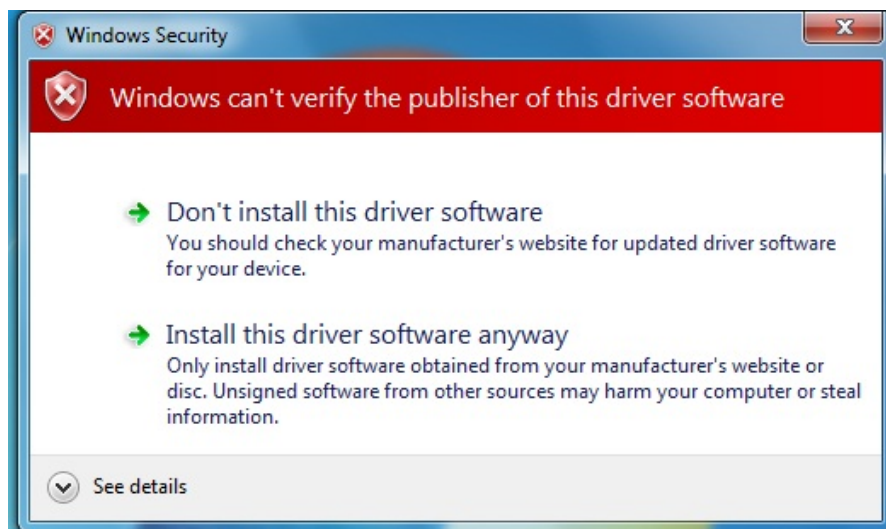

Figure 3. Windows Security

5. Connect the reader. After installation is complete, the message shown in [Figure 4](#) is displayed.

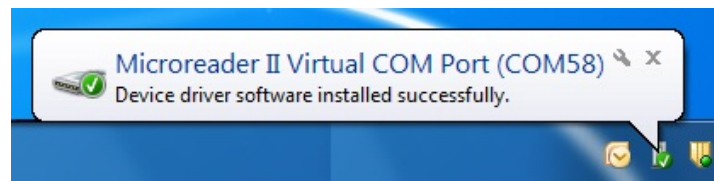

Figure 4. Driver Installed Successfully

6. The USB driver is now installed on the PC, and the system is ready for use.

4.1.2 Windows XP

1. Connect the RI-STU-MRD2 EVM to USB port. When the window shown in [Figure 5](#) is displayed, click "Yes, this time only" and then click Next.



Figure 5. New Hardware Wizard, Step 1

2. When the window shown in [Figure 6](#) is displayed, click "Install from a list or Specific location" and then click Next.

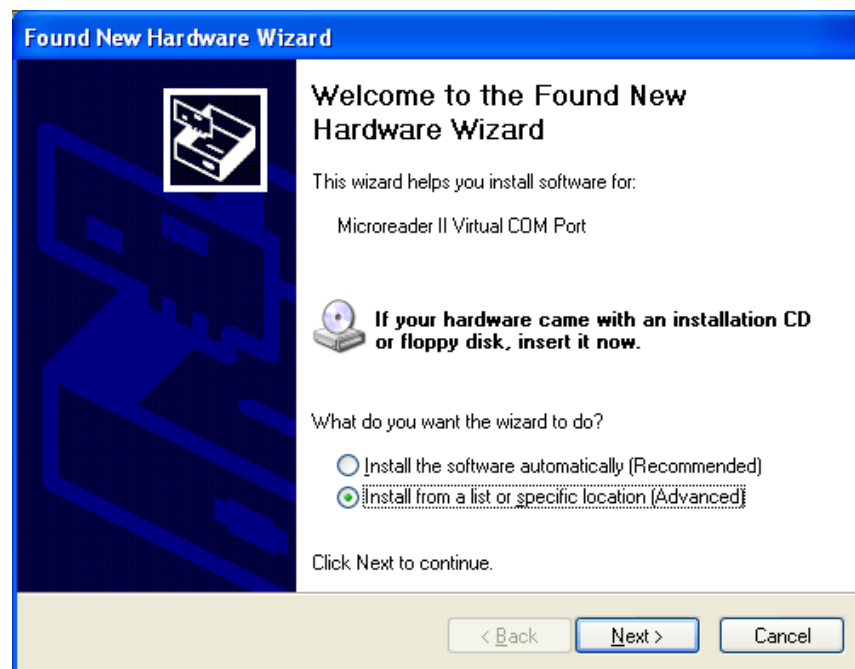

Figure 6. New Hardware Wizard, Step 2

- When the window shown in [Figure 7](#) is displayed, click Browse, select the location of the downloaded driver file on the PC, and then click Next.

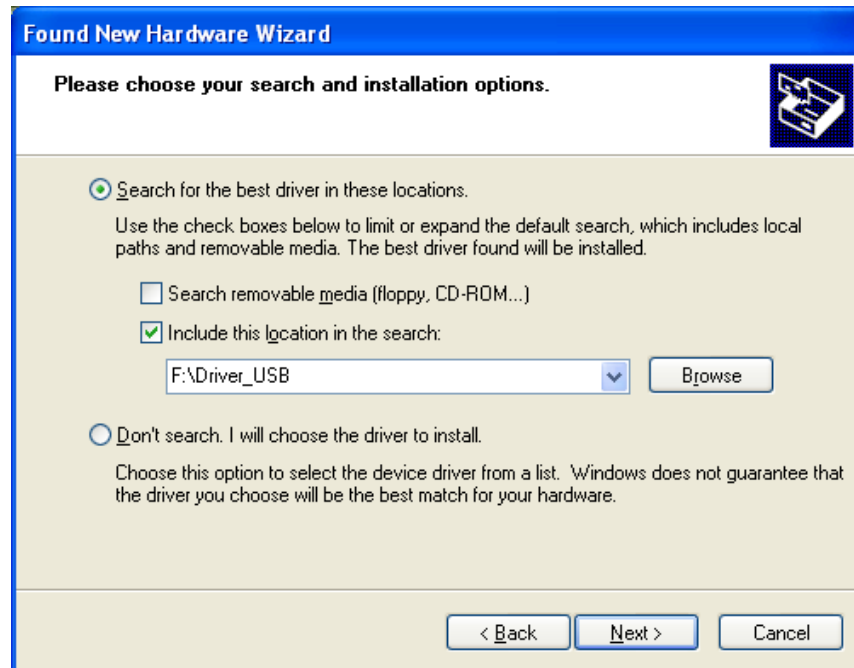

Figure 7. New Hardware Wizard, Step 3

- If Windows prompts for authentication, continue with the installation. After successful installation, the window shown in [Figure 8](#) is displayed. Click Finish.

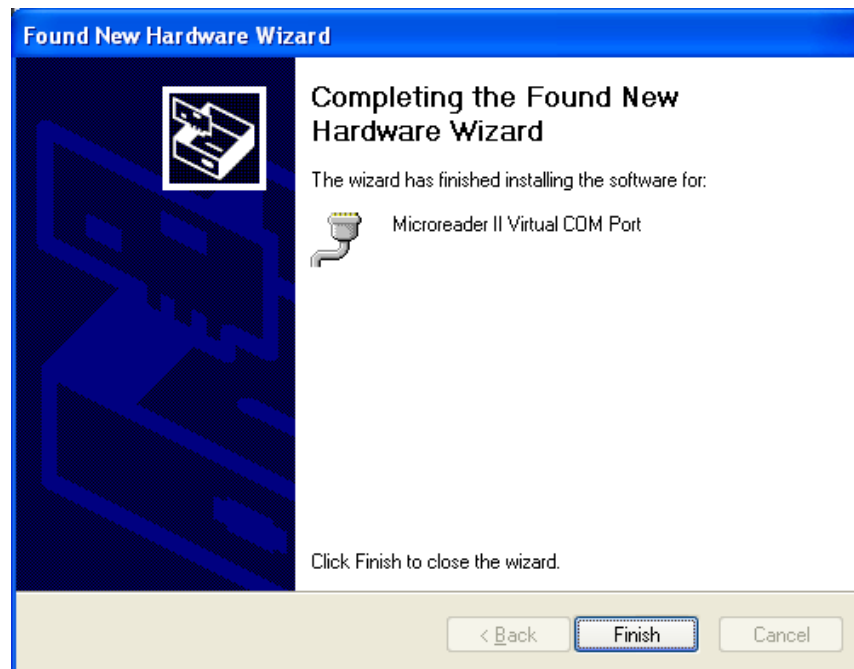

Figure 8. New Hardware Wizard, Step 4

- The USB driver is now installed on the PC, and the system is ready to use.

4.2 RI-STU-MRD2 Demo Software (GUI) Installation

Download the driver from the link specified in 3. Download the software

1. Unpack RI-STU-MRD2 Demo Software.zip.
2. Double click the RI-STU-MRD2 Demo Reader Software.exe.

5 RI-STU-MRD2 Demo Software (GUI) Introduction

The RI-STU-MRD2 demo Software supports simple reading/programming of LF HDX, HDX+, Advanced HDX+ and PaLFI Transponders. When the reader connects to the USB port, the software automatically detects the reader and the COM port data is displayed on the top as shown in below in [Figure 9](#). The five tabs described in [Table 2](#) define use mode depending on type of transponders.

Table 2. GUI Tabs

Tab	Name	Contents and Functions
1	LF / HDX+	Read or write LF tags (R/O, R/W, or MPT 16 /17); read or write memory of HDX+ tags
2	OTP/HDX+ Programming/Tuning	Read or write ID; HDX+ tag read or write ID and tune resonance frequency
3	HDX+ Inventory	Inventory process (read aids of group of HDX+ transponders)
4	PaLFI Transponder	Read, write, battery check, battery charge, MSP access
5	About	Software and hardware version of the RI-STU-MRD2 reader

The initial screen view with the tabs and COM port data is shown in [Figure 9](#).

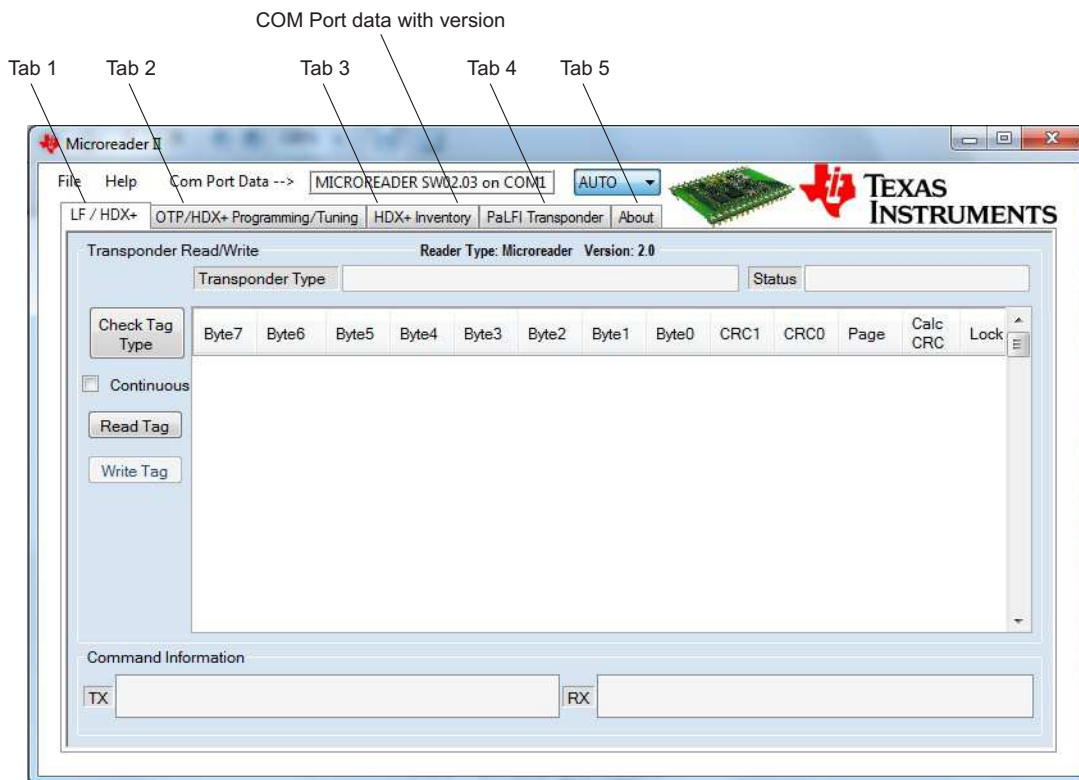

Figure 9. RI-STU-MRD2 Demo Software (GUI): Startup Screen

6 Demo Examples

6.1 Demo 1: Read or Write LF Transponder (Read Only/ Read Write) – Tab 1

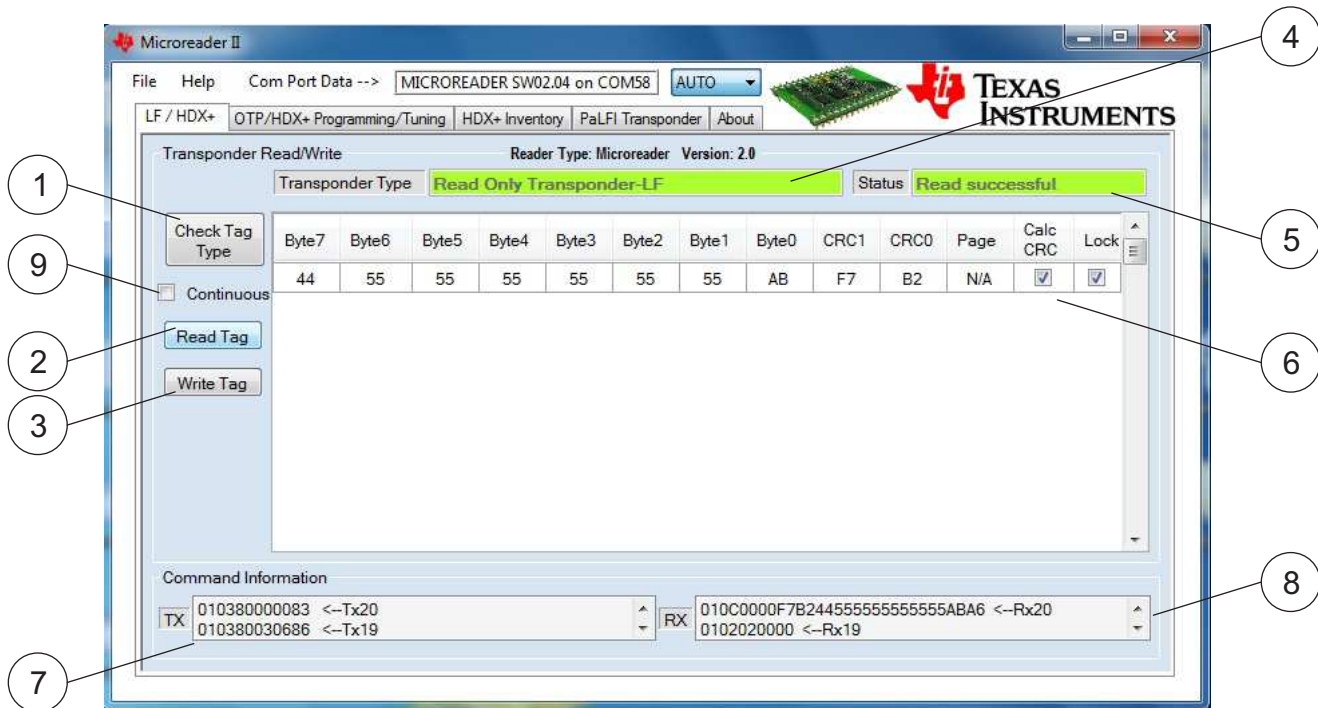
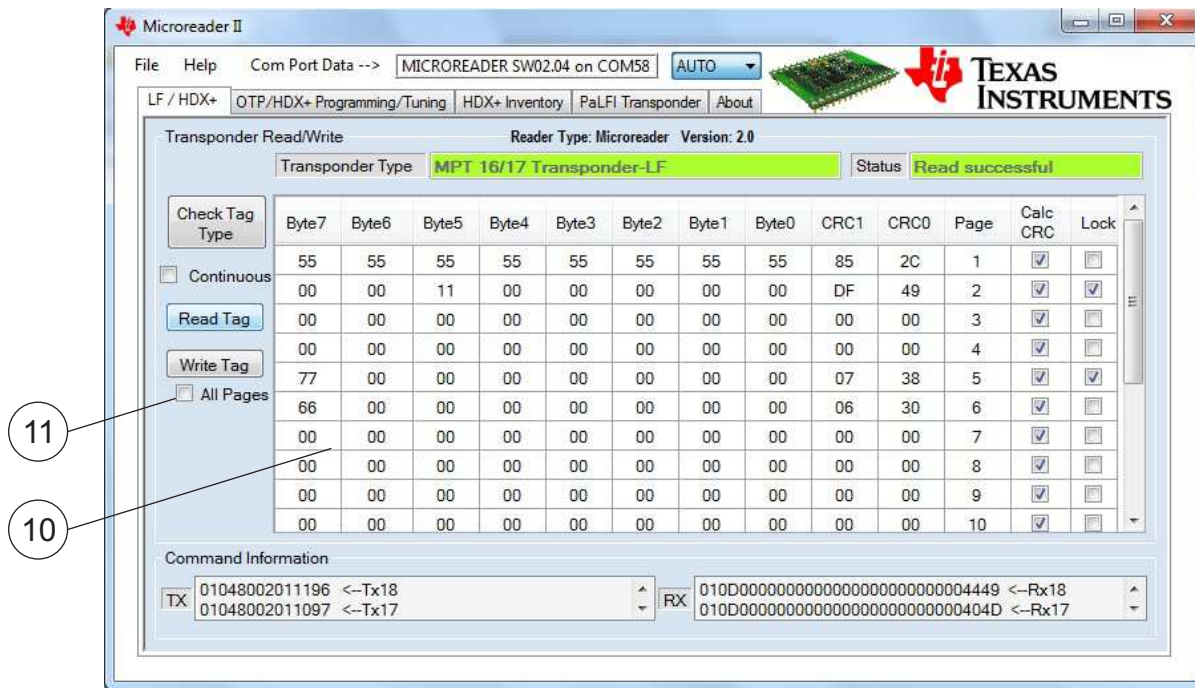

Figure 10. Read or Write LF Transponder (Type: Read-Only or Read/Write)

- 1 Check Tag Type button: Shows the tag type at position 4 (Transponder Type).
- 2 Read Tag button: Reads transponder data, depending on the transponder type. For read only and read/write transponder types, shows LF-8 byte data with 2-byte CRC and data at position 6 of [Figure 10](#). For MPT 16/17 types, shows 16/17 pages with each page of 8-byte data and 2-byte CRC at position 10 of [Figure 11](#). For HDX+ types, shows 16 pages of 4-byte data at position 12 of [Figure 12](#).
- 3 Write Tag button: Programs the transponder, depending on the transponder type. For LF-R/W type transponders, writes 8-byte data with 2-byte CRC (or) 10-byte data. Data can be edited at position 6 of [Figure 10](#) as described in position 6, below. For MPT 16/17 type transponders, writes 16/17 pages with each page of 8-byte date and 2-byte CRC. Data can be edited at position 10 of [Figure 11](#) as described in [Section 6.2](#). For HDX+ type transponders, writes 16 pages of 4-byte data. Data can be edited at position 12 of [Figure 12](#) as described in [Section 6.3](#).
- 4 Shows the type of the transponder. If no transponder is found, "no transponder detected" is shown.
- 5 Shows the status (success or error) of the most recent activity.
- 6 Shows the 10-byte data field (8-byte ID and 2-byte CRC) of the LF Transponder (R/O or R/W) in the first row of the table. Data appears after the successful read of transponder. The Lock column on the right side of table shows the lock status of every single memory row. To lock the transponder check the Lock box and click Write Tag. Check the Calc CRC box to write 8-byte data (the CRC is calculated by the reader). Uncheck the Calc CRC box to write 10-byte data (the CRC is not calculated by the reader).
- 7 Shows the last 20 commands transmitted to reader.
- 8 Shows the last 20 commands received from reader.
- 9 Continuous mode operation check box.

6.2 Demo 2: Read or Write LF Transponder (MPT 16/17) – Tab 1



NOTE: See descriptions of positions 1, 2, 3, 4, 5, 7, 8, and 9 in Figure 10 for additional details.

Figure 11. Read or Write LF Transponder (Type: MPT 16/17)

- 10 This is the 16/17-page 10-byte data (8-byte data with 2-byte CRC) of the LF Transponder MPT 16/17. Data appears after a successful transponder read. The Lock column on the right side of the transponder data shows the lock status of every memory block. To lock the transponder pages, check the Lock box of any page and click Write Tag (see the description of position 11 for important details of writing to the tag). Check the Calc CRC box to write 8-byte data (the CRC is calculated by the reader). Uncheck the Calc CRC box to write 10-byte data (the CRC is not calculated by the reader).
- 11 Check this box and click Write Tag to write all pages of the MPT 16/17 transponder at one time. Uncheck this box and click Write Tag to write only the edited page data. If the data has not been edited, then reader writes the default page 1 data as shown in Figure 10.

6.3 Demo 3: HDX+ Transponder (Read or Write Memory) – Tab 1

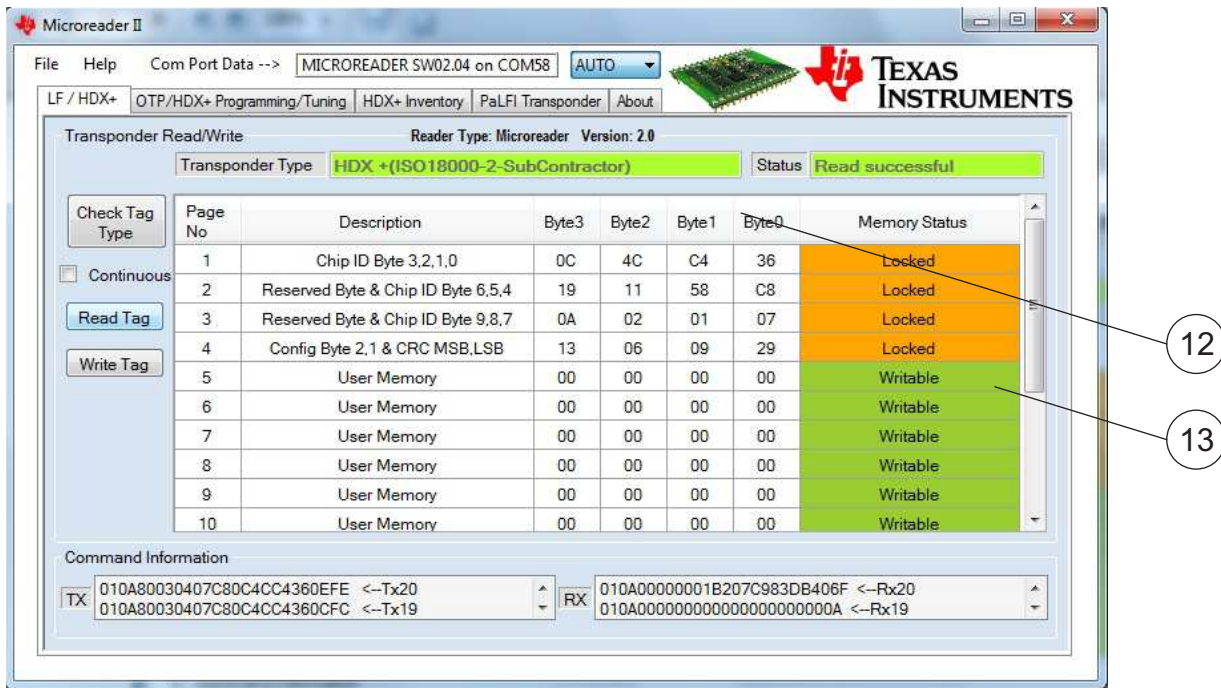

NOTE: See descriptions of positions 1, 2, 3, 4, 5, 7, 8, and 9 in [Figure 10](#) for additional details.

Figure 12. Read or Write Memory Content of HDX+ Transponder

- 12 This is the 16 page (64 byte) memory data of the HDX+-Transponder shown in grid view table format. The description of each page is described in column 2 and the corresponding 4 byte data is displayed in column 3, 4, 5 & 6 of the table as shown in table at position 12.
- 13 This is the last column of the grid view table that shows the memory status of each page. The locked pages with orange background are not re-writable. The writable pages with green background are re-writable.

6.4 Demo 4: OTP Transponder (Read or Write ID) – Tab 2

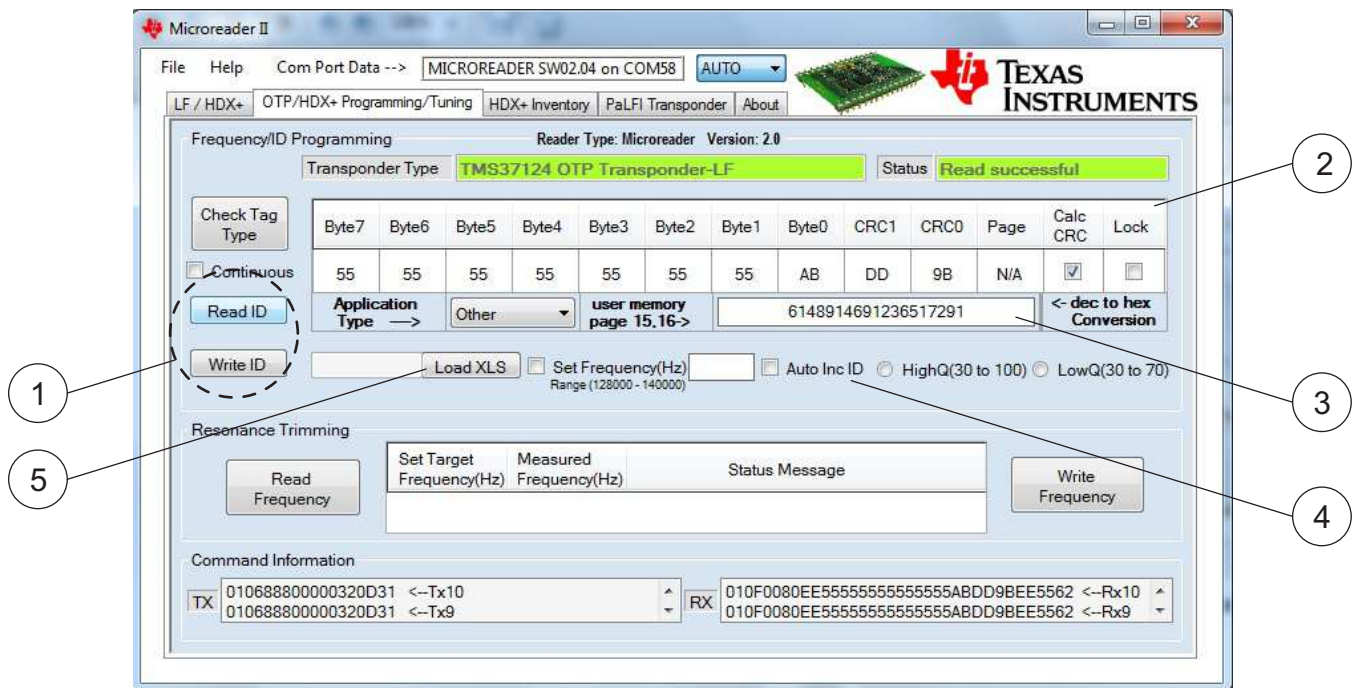

Figure 13. Read or Write ID of OTP Transponder

- 1 Click on Read ID (or) Write ID buttons to read (or) write the 64 byte ID with 16 byte CRC to an OTP transponder.
- 2 This is the 10 byte data (8 byte ID and 2 byte CRC) of the OTP Transponder shown in grid view table first row. The Lock column on the right side of the transponder data shows the lock stats of the ID. To lock the transponder check the Lock box and click Write ID.
- 3 Decimal field for ISO 11785 animal or industrial code. This automatically converts to 8 byte hex data in field 2. If hex data is entered in field 2, data automatically converts to decimal data in field 3.
- 4 Auto increment the ID after successful programming of a transponder.
- 5 Loads a list of IDs from an Excel® spreadsheet to write a batch of transponders. The Auto Inc ID checkbox at position 4 needs to be checked to load the subsequent ID from the Excel spreadsheet after each successful write to the transponder. Click Unload XLS to remove the loaded data.

6.5 Demo 5: HDX+ Transponder (Read or Write ID) – Tab 2

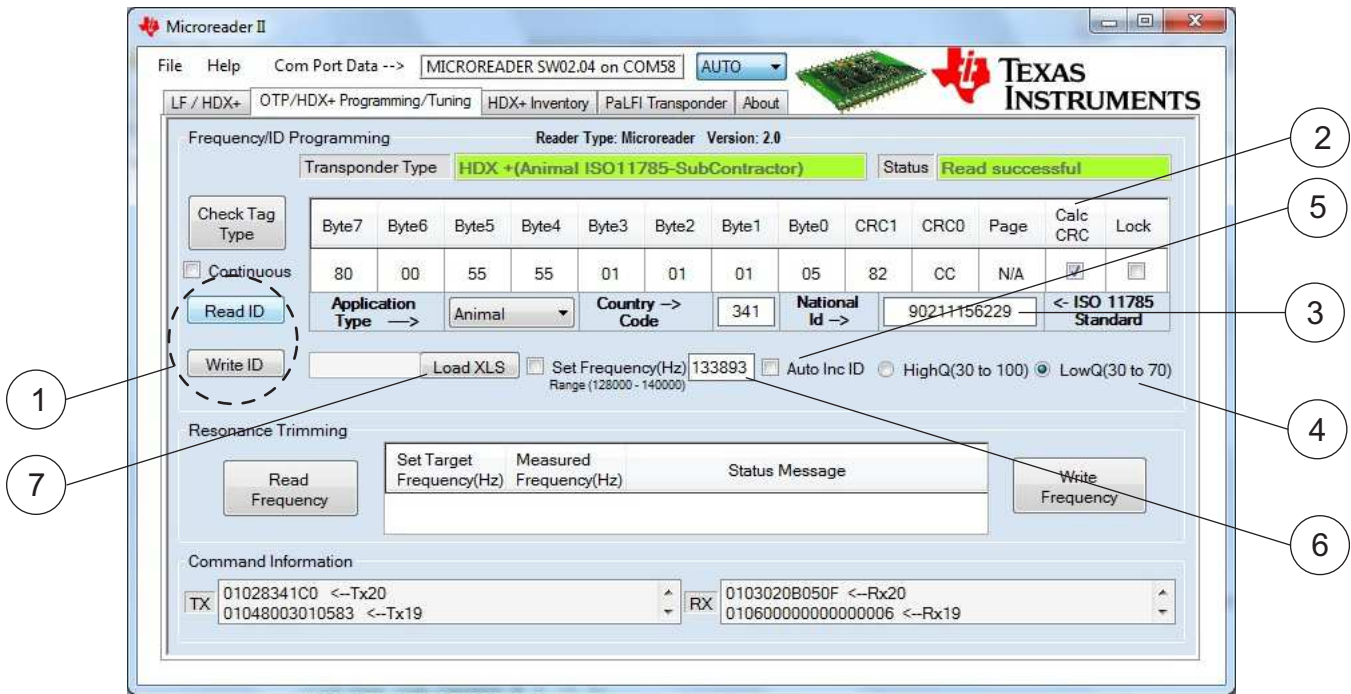

Figure 14. Read or Write ID of HDX+ Transponder

- 1 Read ID (or) Write ID button initiates a read (or) write of the 64 byte ID with 16 byte CRC of an HDX+ transponder.
- 2 This is the 10 byte data (8 byte ID and 2 byte CRC) of the OTP HDX+ Transponder shown in the grid view table first row. The Lock column on the right hand side of the transponder data shows the lock stats of the ID. To lock the transponder check on the Lock checkbox and click on write ID button.
- 3 Decimal field for ISO 11785 animal or industrial code. This automatically converts to 8 byte hex data in field 2. If HEX data is entered in field 2, data automatically converts to decimal data in field 3.
- 4 Q-value of the transponder. Select the correct Q-value of the transponder and click Write ID to write to the transponder.
- 5 Auto increment the ID after successful programming of a transponder.
- 6 Read or write the resonance frequency of a transponder. The frequency of a transponder is shown in this field. To set the frequency at the same time of write ID phase, check the Set Frequency box and type the target frequency in the field.
- 7 Loads a list of IDs from an Excel® spreadsheet to write a batch of transponders. The Auto Inc ID checkbox at position 5 needs to be checked to load the subsequent ID from the Excel® spreadsheet after each successful write to the transponder. Click Unload XLS to remove the loaded data.

6.6 Demo 6: HDX+ Transponder (Trim Frequency) – Tab 2

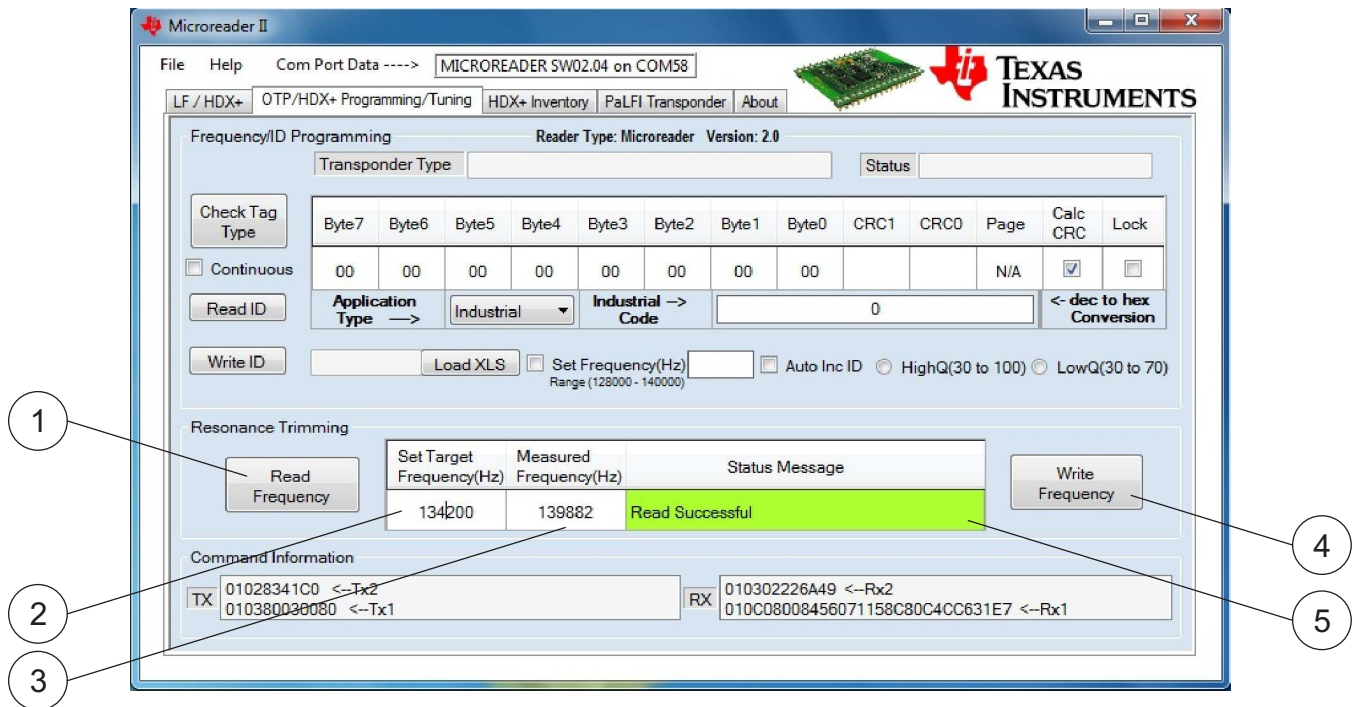

Figure 15. Trim Resonance Frequency of HDX+ Transponder

- 1 Tune or read the frequency of transponder: Click Read Frequency to display the measured frequency value at position 3 (the default target frequency value is displayed at position 2).
- 2 Target frequency field in Hz
- 3 Measured frequency value after each read/write.
- 4 A valid frequency (128000Hz to 140000Hz) needs to be entered in field 2, the frequency is then programmed with the Write frequency button.

NOTE: Depending on transponder form factor, the tag needs to be separated from the antenna by 20 mm to 40 mm to measure and program the correct frequency. The resulting frequency might vary ± 500 Hz due to the limited resolution of the internal tuning circuit.

- 5 Status message field.

6.7 Demo 7: HDX+ Transponders (Inventory Command) – Tab 3

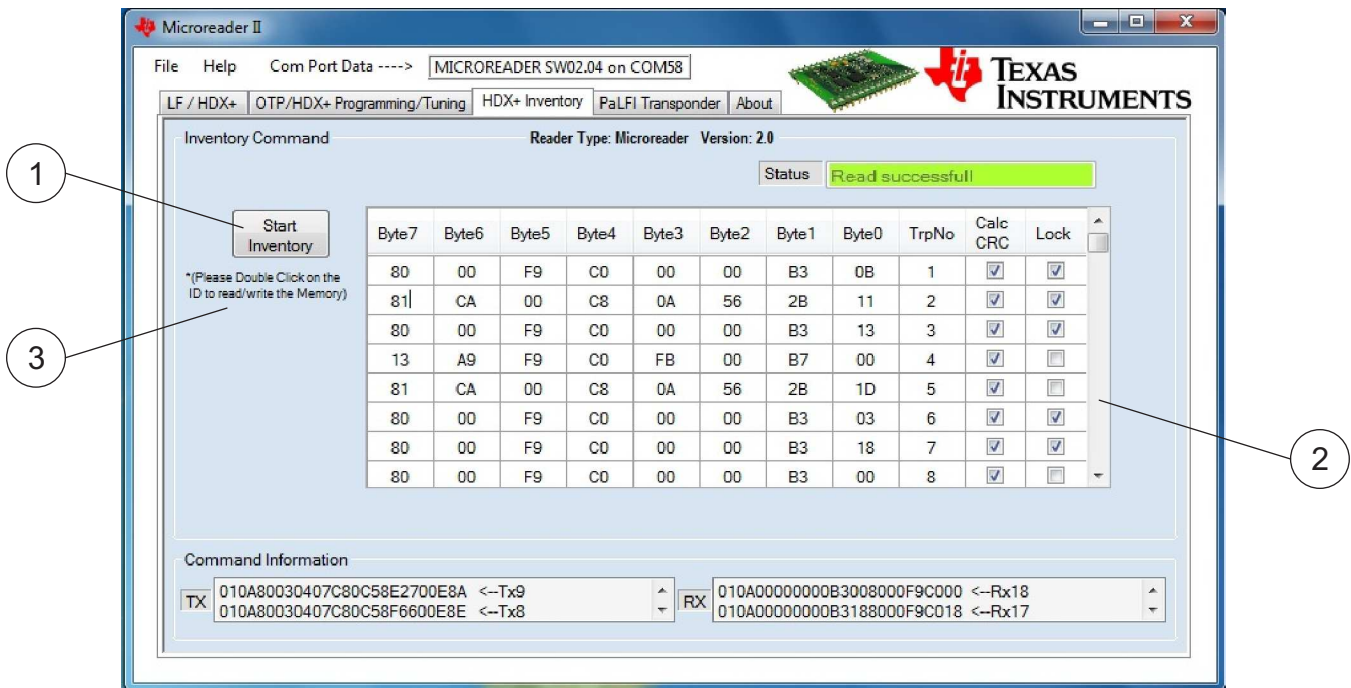

Figure 16. Read Inventory of HDX+ Transponder

- 1 Start inventory button: Reads AIDs of a group of advanced HDX+ transponders in the vicinity region. The list of AIDs of transponders is shown at position 2 of Figure 10.
- 2 This is the 8 byte ID (8 byte AID) of the HDX+-Transponders detected and shown in each row of grid view table. The Lock column on the right hand side of the transponder data shows the lock status of the IDs.
- 3 A double click on any of ID data in the table initiates a read of the memory content of the selected transponder.

6.8 Demo 8: PaLFI (Read, Write, Battery Charge and Check, and Flash LED) – Tab 4

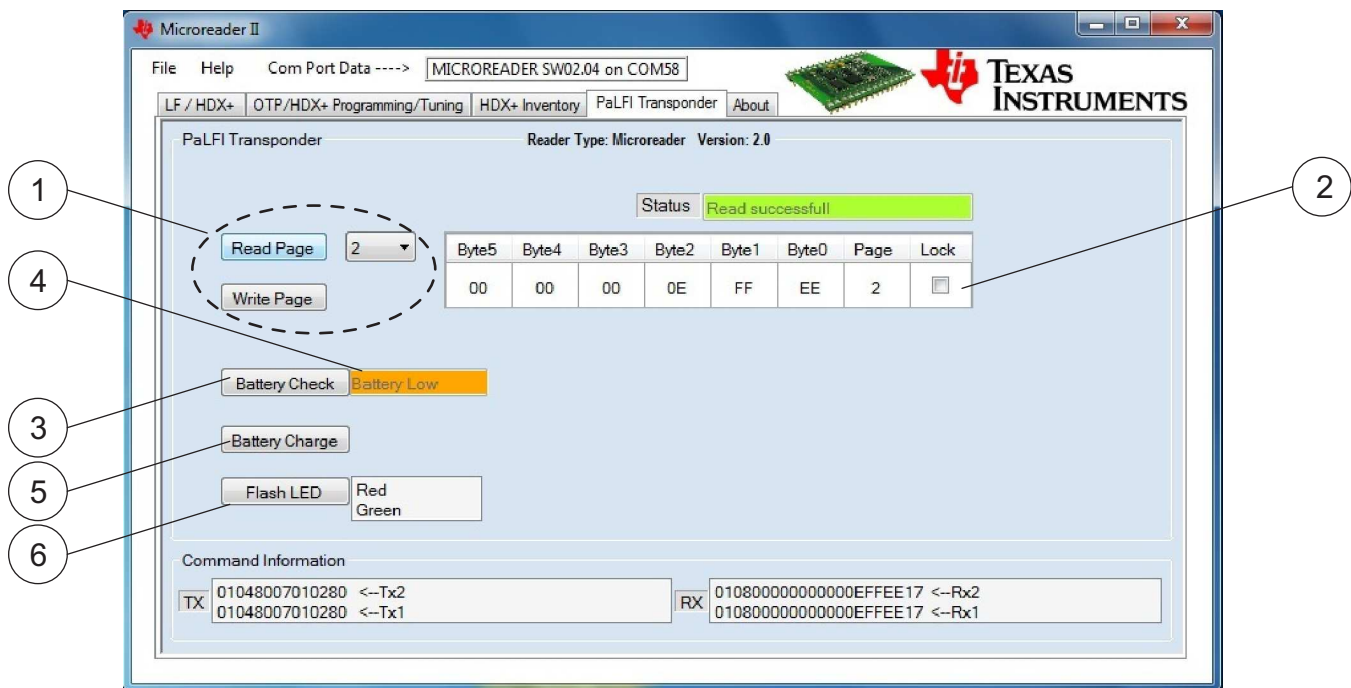

Figure 17. Read, Write, Battery Charge, Battery Check, and Flash LED of PaLFI

- 1 Selection of page number and click on read/write page reads/writes the memory content of the selected page.
- 2 The grid view table shows the 5 byte memory content of the selected page. The Lock field on the right hand side of the memory data shows the lock status of the IDs.
- 3 Battery Check button: Battery voltage level check of PaLFI.
- 4 Battery charge status is indicated with 3 different colors orange (low voltage), yellow (medium voltage) and green (high voltage).
- 5 Battery charge button: Charge PaLFI module.
- 6 Flash LED: Selection of the LED color in the field. A click on the flash LED button initiates the corresponding LED to blink on PaLFI tag which is providing an example for an MSP access command to the PaLFI tag.

7 Schematics

7.1 RI-STU-MRD2 EVM Board

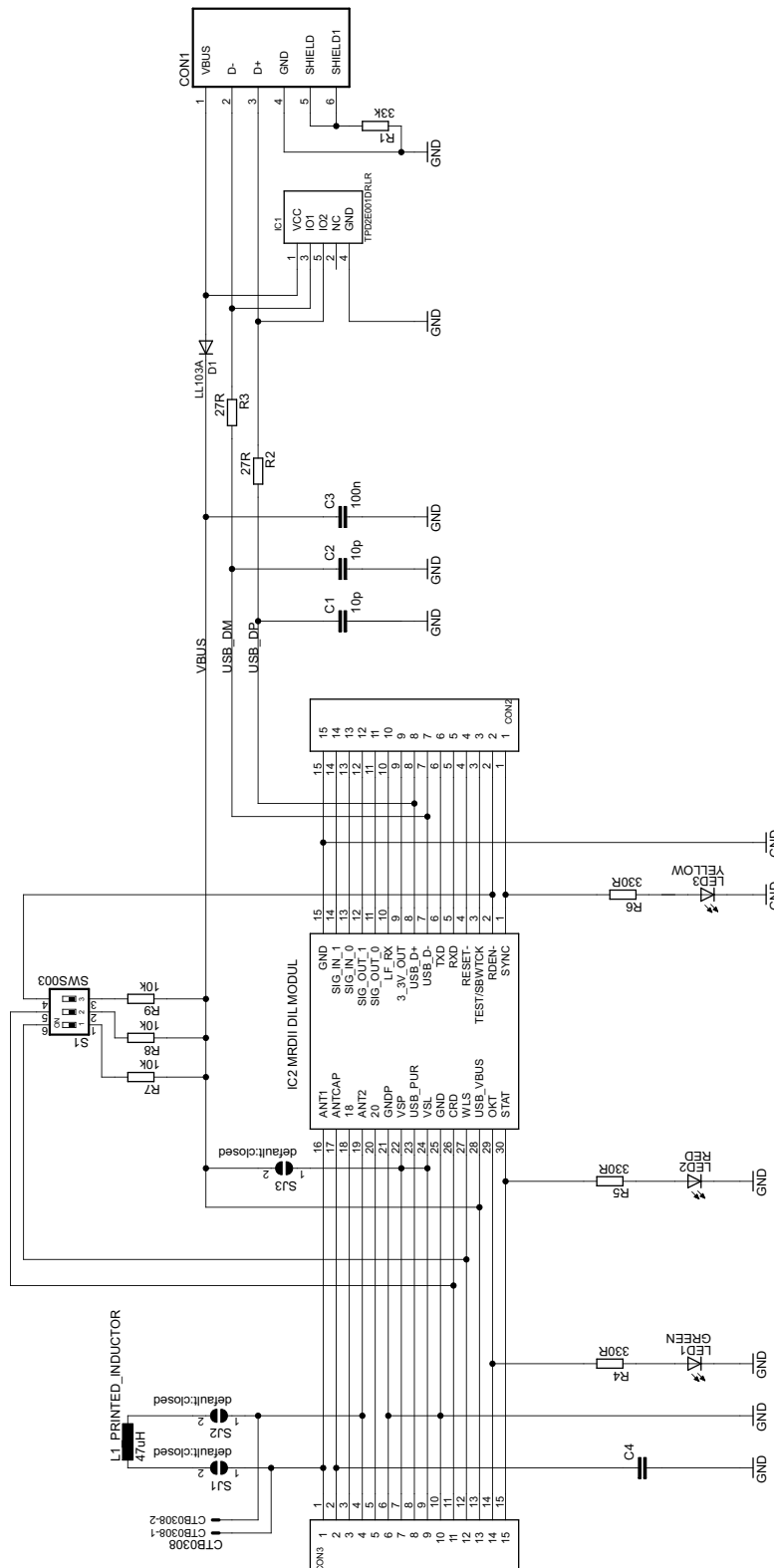

Figure 18. RI-STU-MRD2 EVM Board Schematic

Revision History

Changes from Original (August 2012) to A Revision	Page
--	-------------

- Added and corrected links to documents and software [6](#)
-

NOTE: Page numbers for previous revisions may differ from page numbers in the current version.

EVALUATION BOARD/KIT/MODULE (EVM) ADDITIONAL TERMS

Texas Instruments (TI) provides the enclosed Evaluation Board/Kit/Module (EVM) under the following conditions:

The user assumes all responsibility and liability for proper and safe handling of the goods. Further, the user indemnifies TI from all claims arising from the handling or use of the goods.

Should this evaluation board/kit not meet the specifications indicated in the User's Guide, the board/kit may be returned within 30 days from the date of delivery for a full refund. THE FOREGOING LIMITED WARRANTY IS THE EXCLUSIVE WARRANTY MADE BY SELLER TO BUYER AND IS IN LIEU OF ALL OTHER WARRANTIES, EXPRESSED, IMPLIED, OR STATUTORY, INCLUDING ANY WARRANTY OF MERCHANTABILITY OR FITNESS FOR ANY PARTICULAR PURPOSE. EXCEPT TO THE EXTENT OF THE INDEMNITY SET FORTH ABOVE, NEITHER PARTY SHALL BE LIABLE TO THE OTHER FOR ANY INDIRECT, SPECIAL, INCIDENTAL, OR CONSEQUENTIAL DAMAGES.

Please read the User's Guide and, specifically, the Warnings and Restrictions notice in the User's Guide prior to handling the product. This notice contains important safety information about temperatures and voltages. For additional information on TI's environmental and/or safety programs, please visit www.ti.com/esh or contact TI.

No license is granted under any patent right or other intellectual property right of TI covering or relating to any machine, process, or combination in which such TI products or services might be or are used. TI currently deals with a variety of customers for products, and therefore our arrangement with the user is not exclusive. TI assumes no liability for applications assistance, customer product design, software performance, or infringement of patents or services described herein.

REGULATORY COMPLIANCE INFORMATION

As noted in the EVM User's Guide and/or EVM itself, this EVM and/or accompanying hardware may or may not be subject to the Federal Communications Commission (FCC) and Industry Canada (IC) rules.

For EVMs **not** subject to the above rules, this evaluation board/kit/module is intended for use for ENGINEERING DEVELOPMENT, DEMONSTRATION OR EVALUATION PURPOSES ONLY and is not considered by TI to be a finished end product fit for general consumer use. It generates, uses, and can radiate radio frequency energy and has not been tested for compliance with the limits of computing devices pursuant to part 15 of FCC or ICES-003 rules, which are designed to provide reasonable protection against radio frequency interference. Operation of the equipment may cause interference with radio communications, in which case the user at his own expense will be required to take whatever measures may be required to correct this interference.

General Statement for EVMs including a radio

User Power/Frequency Use Obligations: This radio is intended for development/professional use only in legally allocated frequency and power limits. Any use of radio frequencies and/or power availability of this EVM and its development application(s) must comply with local laws governing radio spectrum allocation and power limits for this evaluation module. It is the user's sole responsibility to only operate this radio in legally acceptable frequency space and within legally mandated power limitations. Any exceptions to this are strictly prohibited and unauthorized by Texas Instruments unless user has obtained appropriate experimental/development licenses from local regulatory authorities, which is responsibility of user including its acceptable authorization.

For EVMs annotated as FCC – FEDERAL COMMUNICATIONS COMMISSION Part 15 Compliant

Caution

This device complies with part 15 of the FCC Rules. Operation is subject to the following two conditions: (1) This device may not cause harmful interference, and (2) this device must accept any interference received, including interference that may cause undesired operation.

Changes or modifications not expressly approved by the party responsible for compliance could void the user's authority to operate the equipment.

FCC Interference Statement for Class A EVM devices

This equipment has been tested and found to comply with the limits for a Class A digital device, pursuant to part 15 of the FCC Rules. These limits are designed to provide reasonable protection against harmful interference when the equipment is operated in a commercial environment. This equipment generates, uses, and can radiate radio frequency energy and, if not installed and used in accordance with the instruction manual, may cause harmful interference to radio communications. Operation of this equipment in a residential area is likely to cause harmful interference in which case the user will be required to correct the interference at his own expense.

FCC Interference Statement for Class B EVM devices

This equipment has been tested and found to comply with the limits for a Class B digital device, pursuant to part 15 of the FCC Rules. These limits are designed to provide reasonable protection against harmful interference in a residential installation. This equipment generates, uses and can radiate radio frequency energy and, if not installed and used in accordance with the instructions, may cause harmful interference to radio communications. However, there is no guarantee that interference will not occur in a particular installation. If this equipment does cause harmful interference to radio or television reception, which can be determined by turning the equipment off and on, the user is encouraged to try to correct the interference by one or more of the following measures:

- Reorient or relocate the receiving antenna.
- Increase the separation between the equipment and receiver.
- Connect the equipment into an outlet on a circuit different from that to which the receiver is connected.
- Consult the dealer or an experienced radio/TV technician for help.

For EVMs annotated as IC – INDUSTRY CANADA Compliant

This Class A or B digital apparatus complies with Canadian ICES-003.

Changes or modifications not expressly approved by the party responsible for compliance could void the user's authority to operate the equipment.

Concerning EVMs including radio transmitters

This device complies with Industry Canada licence-exempt RSS standard(s). Operation is subject to the following two conditions: (1) this device may not cause interference, and (2) this device must accept any interference, including interference that may cause undesired operation of the device.

Concerning EVMs including detachable antennas

Under Industry Canada regulations, this radio transmitter may only operate using an antenna of a type and maximum (or lesser) gain approved for the transmitter by Industry Canada. To reduce potential radio interference to other users, the antenna type and its gain should be so chosen that the equivalent isotropically radiated power (e.i.r.p.) is not more than that necessary for successful communication.

This radio transmitter has been approved by Industry Canada to operate with the antenna types listed in the user guide with the maximum permissible gain and required antenna impedance for each antenna type indicated. Antenna types not included in this list, having a gain greater than the maximum gain indicated for that type, are strictly prohibited for use with this device.

Cet appareil numérique de la classe A ou B est conforme à la norme NMB-003 du Canada.

Les changements ou les modifications pas expressément approuvés par la partie responsable de la conformité ont pu vider l'autorité de l'utilisateur pour actionner l'équipement.

Concernant les EVMs avec appareils radio

Le présent appareil est conforme aux CNR d'Industrie Canada applicables aux appareils radio exempts de licence. L'exploitation est autorisée aux deux conditions suivantes : (1) l'appareil ne doit pas produire de brouillage, et (2) l'utilisateur de l'appareil doit accepter tout brouillage radioélectrique subi, même si le brouillage est susceptible d'en compromettre le fonctionnement.

Concernant les EVMs avec antennes détachables

Conformément à la réglementation d'Industrie Canada, le présent émetteur radio peut fonctionner avec une antenne d'un type et d'un gain maximal (ou inférieur) approuvé pour l'émetteur par Industrie Canada. Dans le but de réduire les risques de brouillage radioélectrique à l'intention des autres utilisateurs, il faut choisir le type d'antenne et son gain de sorte que la puissance isotrope rayonnée équivalente (p.i.r.e.) ne dépasse pas l'intensité nécessaire à l'établissement d'une communication satisfaisante.

Le présent émetteur radio a été approuvé par Industrie Canada pour fonctionner avec les types d'antenne énumérés dans le manuel d'usage et ayant un gain admissible maximal et l'impédance requise pour chaque type d'antenne. Les types d'antenne non inclus dans cette liste, ou dont le gain est supérieur au gain maximal indiqué, sont strictement interdits pour l'exploitation de l'émetteur.

【Important Notice for Users of this Product in Japan】

This development kit is NOT certified as Confirming to Technical Regulations of Radio Law of Japan

If you use this product in Japan, you are required by Radio Law of Japan to follow the instructions below with respect to this product:

1. Use this product in a shielded room or any other test facility as defined in the notification #173 issued by Ministry of Internal Affairs and Communications on March 28, 2006, based on Sub-section 1.1 of Article 6 of the Ministry's Rule for Enforcement of Radio Law of Japan,
2. Use this product only after you obtained the license of Test Radio Station as provided in Radio Law of Japan with respect to this product, or
3. Use of this product only after you obtained the Technical Regulations Conformity Certification as provided in Radio Law of Japan with respect to this product. Also, please do not transfer this product, unless you give the same notice above to the transferee. Please note that if you could not follow the instructions above, you will be subject to penalties of Radio Law of Japan.

Texas Instruments Japan Limited
(address) 24-1, Nishi-Shinjuku 6 chome, Shinjuku-ku, Tokyo, Japan

This development kit is NOT certified as Confirming to Technical Regulations of Radio Law of Japan

<http://www.tij.co.jp>

【ご使用にあたっての注】

本開発キットは技術基準適合証明を受けておりません。

本製品のご使用に際しては、電波法遵守のため、以下のいずれかの措置を取っていただく必要がありますのでご注意ください。

1. 電波法施行規則第6条第1項第1号に基づく平成18年3月28日総務省告示第173号で定められた電波暗室等の試験設備でご使用いただく。
2. 実験局の免許を取得後ご使用いただく。
3. 技術基準適合証明を取得後ご使用いただく。

なお、本製品は、上記の「ご使用にあたっての注意」を譲渡先、移転先に通知しない限り、譲渡、移転できないものとします。

上記を遵守頂けない場合は、電波法の罰則が適用される可能性があることをご留意ください。

日本テキサス・インスツルメンツ株式会社

東京都新宿区西新宿 6 丁目 2 4 番 1 号

西新宿三井ビル

<http://www.tij.co.jp>

EVALUATION BOARD/KIT/MODULE (EVM) WARNINGS, RESTRICTIONS AND DISCLAIMERS

For Feasibility Evaluation Only, in Laboratory/Development Environments. Unless otherwise indicated, this EVM is not a finished electrical equipment and not intended for consumer use. It is intended solely for use for preliminary feasibility evaluation in laboratory/development environments by technically qualified electronics experts who are familiar with the dangers and application risks associated with handling electrical mechanical components, systems and subsystems. It should not be used as all or part of a finished end product.

Your Sole Responsibility and Risk. You acknowledge, represent and agree that:

1. You have unique knowledge concerning Federal, State and local regulatory requirements (including but not limited to Food and Drug Administration regulations, if applicable) which relate to your products and which relate to your use (and/or that of your employees, affiliates, contractors or designees) of the EVM for evaluation, testing and other purposes.
2. You have full and exclusive responsibility to assure the safety and compliance of your products with all such laws and other applicable regulatory requirements, and also to assure the safety of any activities to be conducted by you and/or your employees, affiliates, contractors or designees, using the EVM. Further, you are responsible to assure that any interfaces (electronic and/or mechanical) between the EVM and any human body are designed with suitable isolation and means to safely limit accessible leakage currents to minimize the risk of electrical shock hazard.
3. You will employ reasonable safeguards to ensure that your use of the EVM will not result in any property damage, injury or death, even if the EVM should fail to perform as described or expected.
4. You will take care of proper disposal and recycling of the EVM's electronic components and packing materials.

Certain Instructions. It is important to operate this EVM within TI's recommended specifications and environmental considerations per the user guidelines. Exceeding the specified EVM ratings (including but not limited to input and output voltage, current, power, and environmental ranges) may cause property damage, personal injury or death. If there are questions concerning these ratings please contact a TI field representative prior to connecting interface electronics including input power and intended loads. Any loads applied outside of the specified output range may result in unintended and/or inaccurate operation and/or possible permanent damage to the EVM and/or interface electronics. Please consult the EVM User's Guide prior to connecting any load to the EVM output. If there is uncertainty as to the load specification, please contact a TI field representative. During normal operation, some circuit components may have case temperatures greater than 60°C as long as the input and output are maintained at a normal ambient operating temperature. These components include but are not limited to linear regulators, switching transistors, pass transistors, and current sense resistors which can be identified using the EVM schematic located in the EVM User's Guide. When placing measurement probes near these devices during normal operation, please be aware that these devices may be very warm to the touch. As with all electronic evaluation tools, only qualified personnel knowledgeable in electronic measurement and diagnostics normally found in development environments should use these EVMs.

Agreement to Defend, Indemnify and Hold Harmless. You agree to defend, indemnify and hold TI, its licensors and their representatives harmless from and against any and all claims, damages, losses, expenses, costs and liabilities (collectively, "Claims") arising out of or in connection with any use of the EVM that is not in accordance with the terms of the agreement. This obligation shall apply whether Claims arise under law of tort or contract or any other legal theory, and even if the EVM fails to perform as described or expected.

Safety-Critical or Life-Critical Applications. If you intend to evaluate the components for possible use in safety critical applications (such as life support) where a failure of the TI product would reasonably be expected to cause severe personal injury or death, such as devices which are classified as FDA Class III or similar classification, then you must specifically notify TI of such intent and enter into a separate Assurance and Indemnity Agreement.

General Texas Instruments High Voltage Evaluation Module (TI HV EVM) User Safety Guidelines

WARNING

Always follow TI's set-up and application instructions, including use of all interface components within their recommended electrical rated voltage and power limits. Always use electrical safety precautions to help ensure your personal safety and the safety of those working around you. Contact TI's Product Information Center <http://support.ti.com> for further information.

Save all warnings and instructions for future reference.

Failure to follow warnings and instructions may result in personal injury, property damage, or death due to electrical shock and burn hazards.

The term TI HV EVM refers to an electronic device typically provided as an open framed, unenclosed printed circuit board assembly. It is *intended strictly for use in development laboratory environments, solely for qualified professional users having training, expertise and knowledge of electrical safety risks in development and application of high voltage electrical circuits. Any other use and/or application are strictly prohibited by Texas Instruments.* If you are not suitable qualified, you should immediately stop further use of the TI HV EVM.

1. Work Area Safety:

- (a) Keep work area clean and orderly.
- (b) Qualified observer(s) must be present any time circuits are energized.
- (c) Effective barriers and signage must be present in the area where the TI HV EVM and its interface electronics are energized, indicating operation of accessible high voltages may be present, for the purpose of protecting inadvertent access.
- (d) All interface circuits, power supplies, evaluation modules, instruments, meters, scopes, and other related apparatus used in a development environment exceeding 50Vrms/75VDC must be electrically located within a protected Emergency Power Off (EPO) protected power strip.
- (e) Use a stable and nonconductive work surface.
- (f) Use adequately insulated clamps and wires to attach measurement probes and instruments. No freehand testing whenever possible.

2. Electrical Safety:

As a precautionary measure, it is always a good engineering practice to assume that the entire EVM may have fully accessible and active high voltages.

- (a) De-energize the TI HV EVM and all its inputs, outputs, and electrical loads before performing any electrical or other diagnostic measurements. Revalidate that TI HV EVM power has been safely de-energized.
- (b) With the EVM confirmed de-energized, proceed with required electrical circuit configurations, wiring, measurement equipment hook-ups, and other application needs, while still assuming the EVM circuit and measuring instruments are electrically live.
- (c) Once EVM readiness is complete, energize the EVM as intended.

WARNING

While the EVM is energized, never touch the EVM or its electrical circuits as they could be at high voltages capable of causing electrical shock hazard.

3. Personal Safety:

- (a) Wear personal protective equipment; for example, latex gloves or safety glasses with side shields or protect EVM in an adequate lucent plastic box with interlocks from accidental touch.

Limitation for safe use: EVMs are not to be used as all or part of a production unit.

IMPORTANT NOTICE

Texas Instruments Incorporated and its subsidiaries (TI) reserve the right to make corrections, enhancements, improvements and other changes to its semiconductor products and services per JESD46, latest issue, and to discontinue any product or service per JESD48, latest issue. Buyers should obtain the latest relevant information before placing orders and should verify that such information is current and complete. All semiconductor products (also referred to herein as "components") are sold subject to TI's terms and conditions of sale supplied at the time of order acknowledgment.

TI warrants performance of its components to the specifications applicable at the time of sale, in accordance with the warranty in TI's terms and conditions of sale of semiconductor products. Testing and other quality control techniques are used to the extent TI deems necessary to support this warranty. Except where mandated by applicable law, testing of all parameters of each component is not necessarily performed.

TI assumes no liability for applications assistance or the design of Buyers' products. Buyers are responsible for their products and applications using TI components. To minimize the risks associated with Buyers' products and applications, Buyers should provide adequate design and operating safeguards.

TI does not warrant or represent that any license, either express or implied, is granted under any patent right, copyright, mask work right, or other intellectual property right relating to any combination, machine, or process in which TI components or services are used. Information published by TI regarding third-party products or services does not constitute a license to use such products or services or a warranty or endorsement thereof. Use of such information may require a license from a third party under the patents or other intellectual property of the third party, or a license from TI under the patents or other intellectual property of TI.

Reproduction of significant portions of TI information in TI data books or data sheets is permissible only if reproduction is without alteration and is accompanied by all associated warranties, conditions, limitations, and notices. TI is not responsible or liable for such altered documentation. Information of third parties may be subject to additional restrictions.

Resale of TI components or services with statements different from or beyond the parameters stated by TI for that component or service voids all express and any implied warranties for the associated TI component or service and is an unfair and deceptive business practice. TI is not responsible or liable for any such statements.

Buyer acknowledges and agrees that it is solely responsible for compliance with all legal, regulatory and safety-related requirements concerning its products, and any use of TI components in its applications, notwithstanding any applications-related information or support that may be provided by TI. Buyer represents and agrees that it has all the necessary expertise to create and implement safeguards which anticipate dangerous consequences of failures, monitor failures and their consequences, lessen the likelihood of failures that might cause harm and take appropriate remedial actions. Buyer will fully indemnify TI and its representatives against any damages arising out of the use of any TI components in safety-critical applications.

In some cases, TI components may be promoted specifically to facilitate safety-related applications. With such components, TI's goal is to help enable customers to design and create their own end-product solutions that meet applicable functional safety standards and requirements. Nonetheless, such components are subject to these terms.

No TI components are authorized for use in FDA Class III (or similar life-critical medical equipment) unless authorized officers of the parties have executed a special agreement specifically governing such use.

Only those TI components which TI has specifically designated as military grade or "enhanced plastic" are designed and intended for use in military/aerospace applications or environments. Buyer acknowledges and agrees that any military or aerospace use of TI components which have **not** been so designated is solely at the Buyer's risk, and that Buyer is solely responsible for compliance with all legal and regulatory requirements in connection with such use.

TI has specifically designated certain components as meeting ISO/TS16949 requirements, mainly for automotive use. In any case of use of non-designated products, TI will not be responsible for any failure to meet ISO/TS16949.

Products

Audio	www.ti.com/audio
Amplifiers	amplifier.ti.com
Data Converters	dataconverter.ti.com
DLP® Products	www.dlp.com
DSP	dsp.ti.com
Clocks and Timers	www.ti.com/clocks
Interface	interface.ti.com
Logic	logic.ti.com
Power Mgmt	power.ti.com
Microcontrollers	microcontroller.ti.com
RFID	www.ti-rfid.com
OMAP Applications Processors	www.ti.com/omap
Wireless Connectivity	www.ti.com/wirelessconnectivity

Applications

Automotive and Transportation	www.ti.com/automotive
Communications and Telecom	www.ti.com/communications
Computers and Peripherals	www.ti.com/computers
Consumer Electronics	www.ti.com/consumer-apps
Energy and Lighting	www.ti.com/energy
Industrial	www.ti.com/industrial
Medical	www.ti.com/medical
Security	www.ti.com/security
Space, Avionics and Defense	www.ti.com/space-avionics-defense
Video and Imaging	www.ti.com/video

TI E2E Community

e2e.ti.com