

TAS5162DDV6EVM2

This user's guide describes the operation of the evaluation module for the TAS5162 Digital Amplifier Power Output Stage using TAS5518 Digital Audio PWM Processor from Texas Instruments. The user's guide also provides measurement data and design information such as the schematic, BOM, and PCB layout

Contents

	Trademarks.....	2
1	Overview.....	2
2	Quick Setup Guide	5
3	Protection.....	7
4	TAS5162DDV6EVM2 Performance	8
5	Related Documentation from Texas Instruments	20
Appendix A	21

List of Figures

1	Integrated PurePath Digital™ Amplifier System.....	4
2	Physical structure for the TAS5162DDV6EVM2 (Approximate Layout)	4
3	TAS5518 GUI Window.....	6
4	THD+N vs Power (BTL - 6Ω).....	10
5	THD+N vs Power (BTL - 8Ω).....	10
6	THD+N vs Power (PBTL - 4Ω).....	11
7	THD+N vs Frequency (BTL - 6Ω).....	11
8	THD+N vs Frequency (BTL - 8Ω).....	12
9	THD+N vs Frequency (PBTL - 4Ω).....	12
10	Figure 10. FFT Spectrum With -60 dBFS Tone (BTL)	13
11	4.8 FFT Spectrum With -60 dBFS Tone (PBTL)	13
12	Idle Noise FFT Spectrum (BTL).....	14
13	Idle Noise FFT Spectrum (PBTL)	14
14	Channel Separation.....	15
15	Frequency Response (BTL)	15
16	Frequency Response (PBTL).....	16
17	High Current Protection (BTL).....	16
18	High Current Protection (PBTL).....	17
19	Pop/Click (BTL).....	17
20	Pop/Click (PBTL)	18
21	Output Stage Efficiency	18
22	Subwoofer Line Out THD Vs. Output Voltage	19
23	Subwoofer Line Out THD+N vs. Frequency	19
24	Subwoofer Line Out Frequency Response	20

List of Tables

1	TAS5162DDV6EVM2 Specification	2
2	Recommended Supply Voltages	5
3	TAS5162 Warning/Error Signal Decoding.....	7
4	General Test Conditions.....	8

5	TAS5518 Register Settings	8
6	Electrical Data.....	8
7	Audio Performance.....	9
8	Audio Performance Subwoofer Line Output	9
9	Thermal Specifications.....	9
10	Physical pecifications	9
11	Related Documentation from Texas Instruments	20
A-1	Design Documents.....	21

Topic	Page

Trademarks

PurePath Digital, Equibit are trademarks of Texas Instruments.

I²C is a trademark of Philips Electronics.

1 Overview

The TAS5162DDV6EVM2 PurePath Digital™ customer evaluation module demonstrates the integrated circuits TAS5162DDV and TAS5518PAG from Texas Instruments.

The TAS5162DDV is a high-performance, integrated stereo Digital Amplifier Power Stage designed to drive 6-Ω speakers at up to 210 W per channel. The device incorporates PurePath Digital™ technology and is designed to be used with PurePath Digital™ modulators. This system requires only a simple passive demodulation filter to deliver high-quality, high-efficiency audio amplification.

TAS5518PAG is a high performance 32 bit (24 bit input) multi channel PurePath Digital™ Pulse Width Modulator (PWM) based on Equibit™ technology with fully symmetrical AD modulation scheme. The device also has Digital Audio Processing (DAP) that provides 48 bit signal processing, advanced performance and a high level of system integration. The device has interfaces for headphone output and Power Supply Volume Control (PSVC).

This EVM is configured with 4 BTL channels and 1 PBTL (parallel BTL) channel for the subwoofer channel.

This EVM, together with a TI input-USB board, is a complete 5 channels + subwoofer line output digital audio amplifier system which includes digital input (S/PDIF), analog inputs, interface to PC and DAP features like digital volume control, input and output mixers, automute, tone controls, loudness, EQ filters and dynamic range compression (DRC). There are configuration option for power stage failure protection and a mini-jack connector for headphone.

Table 1. TAS5162DDV6EVM2 Specification

Key Parameters	
Output Stage Supply Voltage:	0V – 50 V
System Supply Voltage:	15V – 20 V
Number of Channels	4 x BTL, 1x PBTL
Load Impedance BTL:	6-8 Ω
Load Impedance PBTL:	4-8 Ω
Output power BTL	160W / 8 Ω 10% THD or 210W / 6 Ω / 10% THD
Output power PBTL	310W / 4 Ω / 10% THD
DNR	>110 dB
PWM Processor	TAS5518PAG
Output Stage	TAS5162DDV
Other Features	Subwoofer line output

This 5 channel system + subwoofer line output is designed for home theater applications such as A/V receivers, DVD receivers, DVD mini-component systems or home theater in a box (HTIB).

This document covers EVM specifications, audio performance and power efficiency measurements graphs, and design documentation that includes schematics, parts list, layout and mechanical design.

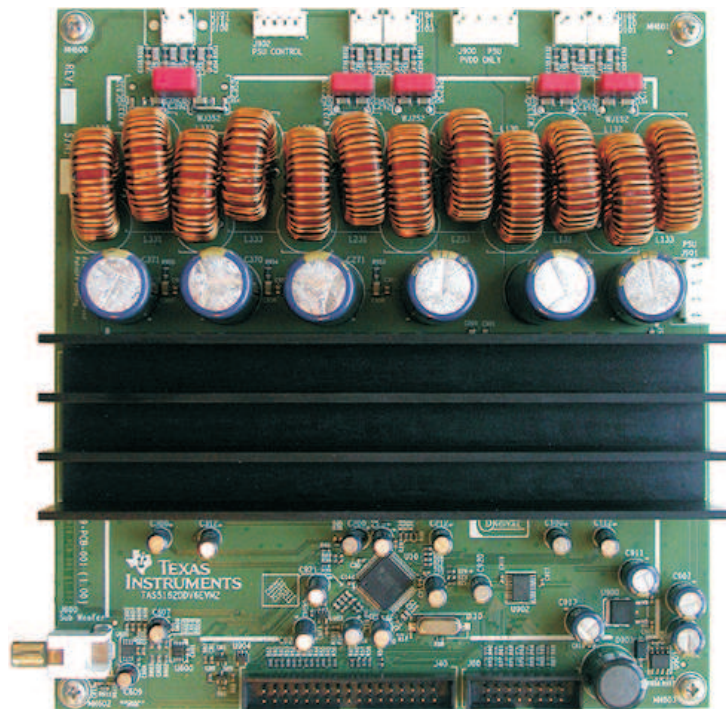

Gerber (layout) files are available at www.ti.com.

The EVM is delivered with cables and Input-USB board to connect to an input source and be controlled from a PC.

1.1 1.1 TAS5162DDV6EVM2 Features

- 5/6 channel PurePath Digital™ evaluation module (double-sided plated-through PCB layout).
- Subwoofer Line Output (LFE Output).
- Self-contained protection system (short-circuit and thermal)
- Standard I²S and I²C™ / Control connector for TI input board
- Double-sided plated-through PCB layout.

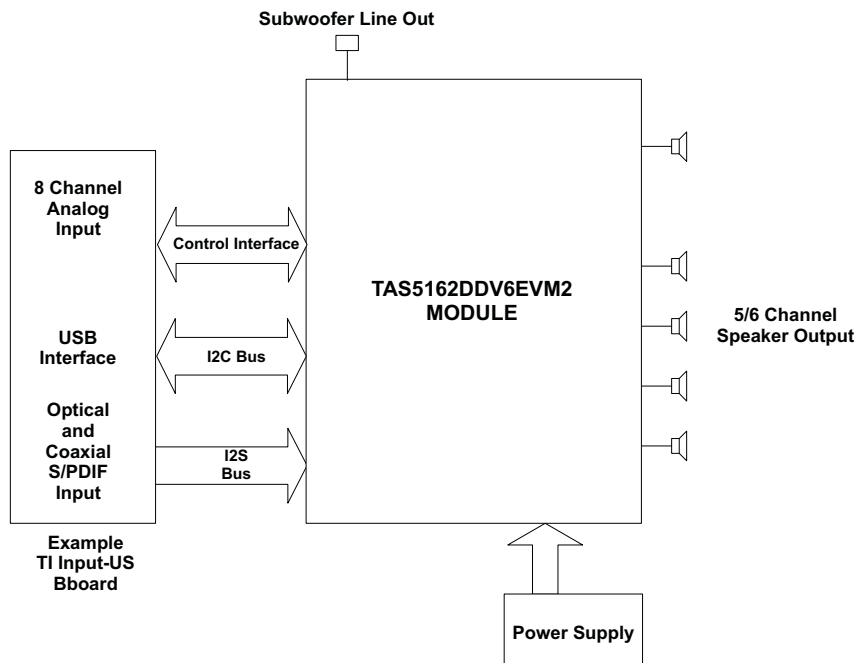

Figure 1. Integrated PurePath Digital™ Amplifier System

1.2 PCB Key Map

Physical structure for the TAS5162DDV6EVM2 is illustrated in Figure 2.

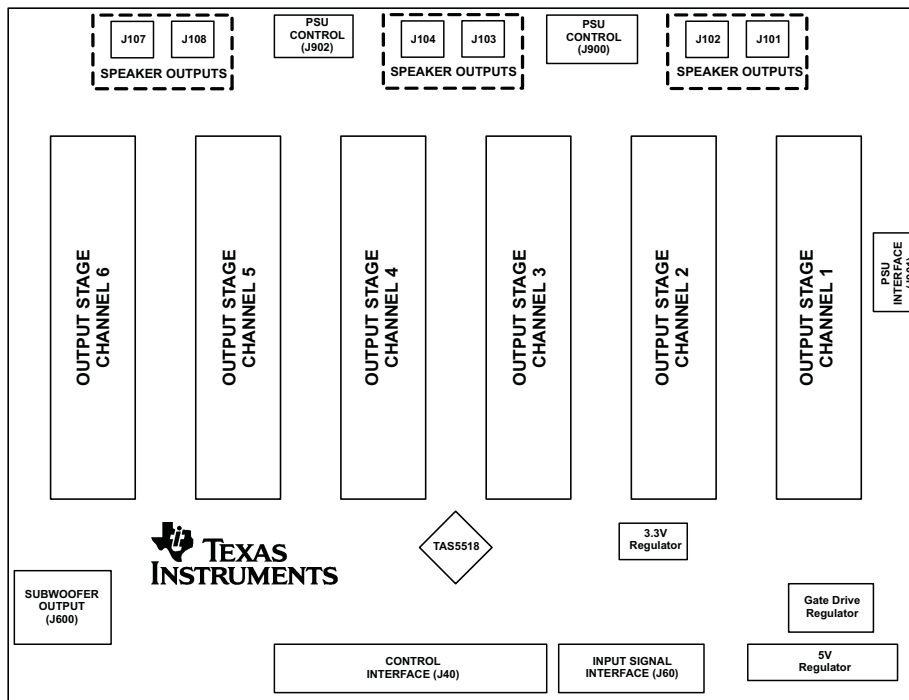

Figure 2. Physical structure for the TAS5162DDV6EVM2 (Approximate Layout)

2 Quick Setup Guide

This chapter describes the TAS5162DDV6EVM2 board in regards to power supplies and system interfaces. The chapter provides information regarding handling and unpacking, absolute operating conditions, and a description of the factory default switch and jumper configuration.

This chapter provides a step-by-step guide to configuring the TAS5162DDV6EVM2 for device evaluation.

2.1 Electrostatic Discharge Warning

Many of the components on the TAS5162DDV6EVM2 are susceptible to damage by electrostatic discharge (ESD). Customers are advised to observe proper ESD handling precautions when unpacking and handling the EVM, including the use of a grounded wrist strap at an approved ESD workstation.

CAUTION

Failure to observe ESD handling procedures may result in damage to EVM components.

2.2 Unpacking the EVM

Upon opening the TAS5162DDV6EVM2 package, check to make sure that the following items are included:

- 1 pc. TAS5162DDV6EVM2 board using one TAS5518PAG and four TAS5162DDV.
- 1 pc. TI Input-USB board for interfacing TAS5162DDV6EVM2 with SPDIF/analog sources and PC for control.
- 1 pc. Signal Interface IDC cable for connection to an I²S front-end like the TI Input-USB board.
- 1 pc. Control Interface IDC cable for connection to an I²C™ front-end like the TI Input-USB board.
- 1 pc Cable for connecting Input-USB board to a USB port on a PC for TAS5518 control by software.
- 1 pc. Power supply cable for one regulated power supplies (H-bridge).
- 1 pc. Power supply cable for two regulated power supplies (H-bridge and System supply).
- 1 pc. PurePath™ CD-ROM

If any of these items are missing, contact the Texas Instruments Product Information Center nearest you to inquire about a replacement.

Connect the Input-USB board to TAS5162DDV6EVM2 using the 2 delivered IDC cables.

2.3 Power Supply Setup

To power up the EVM two power supplies are needed. One for system power, logic and gate-drive, and one for output stage supply. Power supplies are connected to the EVM using delivered power cable Red/Black, White/Black.

Table 2. Recommended Supply Voltages

Description	Voltage Limitations	Current Requirement	Cable
System power supply	15 – 20 V	0.3 A	Red/Black
Output stage power supply	0 – 50 V	10 A	White/Black

CAUTION

Applying voltages above the limitations given in [Table 2](#) may cause permanent damage to the hardware.

Note: The length of power supply cable must be minimized. Increasing length of PSU cable is equal to increasing the distortion for the amplifier at high output levels and low frequencies.

2.4 Speaker Connection

CAUTION

Both positive and negative speaker outputs are floating and may not be connected to ground (e.g. through an oscilloscope).

2.5 GUI Software Installation

The TAS5518 GUI provides easy control of all registers in the TAS5518. To install the GUI, run setup file from the PurePath™ CD-ROM.

After installation, turn on the power supplies and connect the USB cable to the Input-USB board.

Start GUI program from windows menu. Start up of GUI will take few seconds.



Figure 3. TAS5518 GUI Window

From the files menu load the configuration file:

TAS5162DDV6EVM2 Configuration (1.00).cfg

The file is located on the PurePath™ CD-rom. This file contains all settings for a default setup of the EVM.

For easy access of the file it is recommended to copy the files into directory where the GUI is installed. Default is C:\Program Files\Texas Instruments Inc\TAS5518\

For more advanced use of the GUI, refer to the GUI User's Guide and data manual for the TAS5518.

3 Protection

This chapter describes the short-circuit protection and fault reporting circuitry of the TAS5162 ([SLES194](#)) device.

3.1 Short Circuit Protection and Fault Reporting Circuitry

The TAS5162 is a self-protecting device that provides fault reporting (including high-temperature protection and short-circuit protection). TAS5162 is configured in back-end auto-recovery mode, and therefore, resets automatically after all errors (M1, M2 and M3 is set low), see the data sheet for further explanation. This mean that the device will restart it self after an error occasion and report shortly through the \overline{SD} error signal.

3.2 Fault Reporting

The \overline{OTW} and \overline{SD} outputs from TAS5162 indicate fault conditions. See the TAS5162 data manual for a description of these pins.

Table 3. TAS5162 Warning/Error Signal Decoding

\overline{OTW}	\overline{SD}	Device Condition
0	0	High temperature error and/or high current error
0	1	High temperature warning
1	0	Undervoltage lockout or high current error
1	1	Normal operation, no errors/warnings

The temperature warning signals at the TAS5162DDV6EVM2 board are wired — or to one temperature warning signal (\overline{OTW} – pin 22 in control interface connector). Shutdown signals are wired-or into one shutdown signal (\overline{SD} – pin 20 in control interface connector).

The shutdown signals together with the temperature warning signal give chip state information as described in [Table 3](#). Device fault reporting outputs are open-drain outputs.

4 TAS5162DDV6EVM2 Performance

All electrical and audio specifications are typical values.

Table 4. General Test Conditions

General Test Conditions ⁽¹⁾		Notes
Output Stage Supply Voltage:	50 V	Laboratory Power Supply (EA-PS 7065-10A)
System Supply Voltage:	15 V	
Load Impedance BTL:	6-8 Ω	
Load Impedance PBTL:	3-4 Ω	
Input Signal	1kHz Sine	
Sampling Frequency	48 kHz	
Gain setting in TAS5518	0 dB	
Measurement Filter	AES17 and AUX0025	
TI Input-USB Board	Input-USB	Rev 10
EVM configuration file	Ver 1.00	TAS5162DDV6EVM2 Configuration (1.00).cfg

⁽¹⁾ These test conditions are used for all tests, unless otherwise specified.

Table 5. TAS5518 Register Settings

Register ⁽¹⁾		Value	Notes
Modulation Index Limit Register	0x16	0x04	Set Modulation Index to 96.1%
Master Volume Register	0xD9	00 00 00 48	Master Volume set to 0 dB

⁽¹⁾ These register settings are used for all test, unless otherwise specified.

Table 6. Electrical Data

Electrical Data		Notes/Conditions
Output Power, BTL, 6 Ω :	155 W	1 kHz, unclipped (0 dBFS), $T_A = 25^\circ\text{C}$
Output Power, BTL, 6 Ω :	210 W	1 kHz, 10% THD+N, $T_A = 25^\circ\text{C}$
Output Power, BTL, 8 Ω :	125 W	1 kHz, unclipped (0 dBFS), $T_A = 25^\circ\text{C}$
Output Power, BTL, 8 Ω :	160 W	1 kHz, 10% THD+N, $T_A = 25^\circ\text{C}$
Output Power, PBTL, 4 Ω :	240 W	1 kHz, unclipped (0 dBFS), $T_A = 25^\circ\text{C}$
Output Power, PBTL, 4 Ω :	315 W	1 kHz, 10% THD+N, $T_A = 25^\circ\text{C}$
Maximum Peak Current, BTL:	>10 A	1 kHz burst, 1 Ω , $R_{OC} = 22k$
Maximum Peak Current, PBTL:	>20 A	1 kHz burst, 1 Ω , $R_{OC} = 22k$
Output Stage Efficiency:	90%	2 x channels, 8 Ω
Damping Factor BTL:	15	1 kHz, relative to 8 Ω load
Damping Factor PBTL:	15	1 kHz, relative to 4 Ω load
System Supply Current:	<270 mA	1 kHz, -60 dBFS signal, with TI input board
H-Bridge Supply Current:	<187 mA	1 kHz, -60 dBFS signal
Total Board Idle Power Consumption:	13.4 W	H-Bridge supply + System supply, -60 dBFS signal

Table 7. Audio Performance

Audio Performance			Notes/Conditions
THD+N, BTL, 6 Ω:	1 W	<0.02%	1 kHz
THD+N, BTL, 6 Ω:	10 W	<0.06%	1 kHz
THD+N, BTL, 6 Ω:	50 W	<0.10%	1 kHz
THD+N, BTL, 6 Ω:	100 W	<0.10%	1 kHz
THD+N, BTL, 6 Ω:	150 W	<0.13%	1 kHz
THD+N, BTL, 8 Ω:	1 W	<0.02%	1 kHz
THD+N, BTL, 8 Ω:	10 W	<0.06%	1 kHz
THD+N, BTL, 8 Ω:	50 W	<0.08%	1 kHz
THD+N, BTL, 8 Ω:	100 W	<0.07%	1 kHz
THD+N, PBTL, 4 Ω:	1 W	<0.009%	1 kHz
THD+N, PBTL, 4 Ω:	10 W	<0.05%	1 kHz
THD+N, PBTL, 4 Ω:	50 W	<0.04%	1 kHz
THD+N, PBTL, 4 Ω:	100 W	<0.05%	1 kHz
THD+N, PBTL, 4 Ω:	200 W	<0.12%	1 kHz
Dynamic Range:		>109 dB	Ref: rated power, A-weighted, AES17 filter, 4 ch avg
Noise Voltage:		<110 μVrms	A-weighted, AES17 filter
Click/Pop, DC step BTL:		10 mV	Mute/Unmute, No signal, 6 Ω
Click/Pop, DC step PBTL:		23 mV	Mute/Unmute, No signal, 4 Ω
Channel Separation:		>65 dB	1 kHz
Frequency Response:		+0.8 / 0.0 dB	125 W / 8 Ω, unclipped (0 dBFS)

Table 8. Audio Performance Subwoofer Line Output

Audio Performance			Notes/Conditions
Full Scale Output Voltage Swing, 0 dBFS:		1.275 Vrms	1 kHz, 10 kΩ load
Full Scale Output Voltage Swing, 10 % THD+N:		1.5 Vrms	1 kHz, 10 kΩ load
THD+N, 10 kΩ:	1 V	<0.009%	1 kHz
THD+N, 10 kΩ:	100 mV	<0.01%	1 kHz
Frequency Response:		+1, -4 dB	20 Hz – 20 kHz
Dynamic Range:		>102 dB	20 Hz – 20 kHz
Noise Voltage:		<10 μV	20 Hz – 20 kHz

Table 9. Thermal Specifications

Thermal Specifications	T _{HEATSINK} ⁽¹⁾	Notes/Conditions
Idle, All Channels Switching	41°C	1 kHz, 15 min, -60 dBFS signal, T _A = 25°C 1 kHz
6 x 16 W, 8 Ω + 1 x 32 W, 4 Ω (1/8 power)	63°C	1 hour, T _A = 25°C
2 x 125 W, 8 Ω	76°C	1 kHz, 5 min, T _A = 25°C

(1) Measured on surface of heatsink.

Table 10. Physical Specifications

Physical Specification		Notes/Conditions
PCB Dimensions:	160 x 172 x 55	Width x Length x Height (mm)
Total Weight:	640 gr.	Components + PCB + Heat-sink + Mechanics

4.1 THD+N vs Power (BTL - 6Ω)

Gain: 2.5 dB set in TAS5518

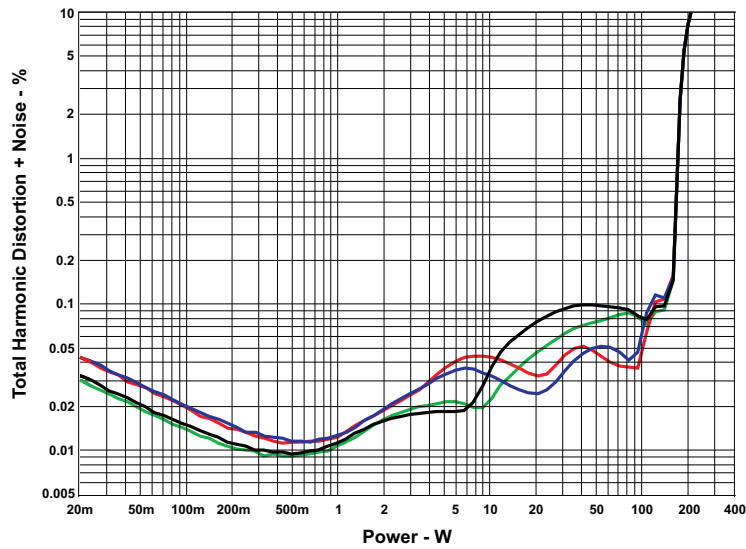

Figure 4. THD+N vs Power (BTL - 6Ω)

4.2 THD+N vs Power (BTL - 8Ω)

Gain: 2.5 dB set in TAS5518

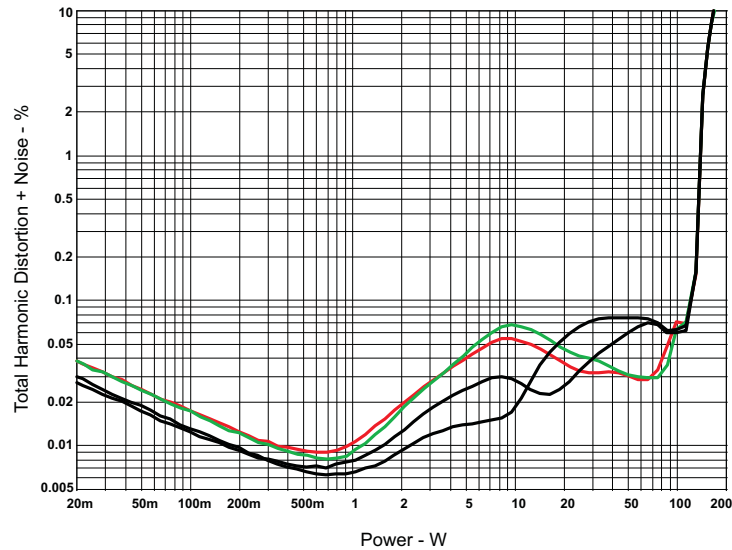

Figure 5. THD+N vs Power (BTL - 8Ω)

4.3 THD+N vs Power (PBTL - 4Ω)

Gain: 2.5 dB set in TAS5518

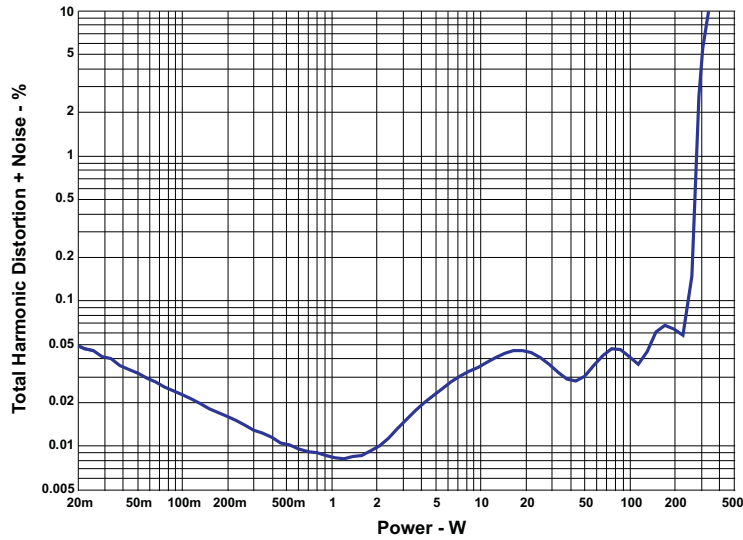

Figure 6. THD+N vs Power (PBTL - 4Ω)

4.4 THD+N vs Frequency (BTL - 6Ω)

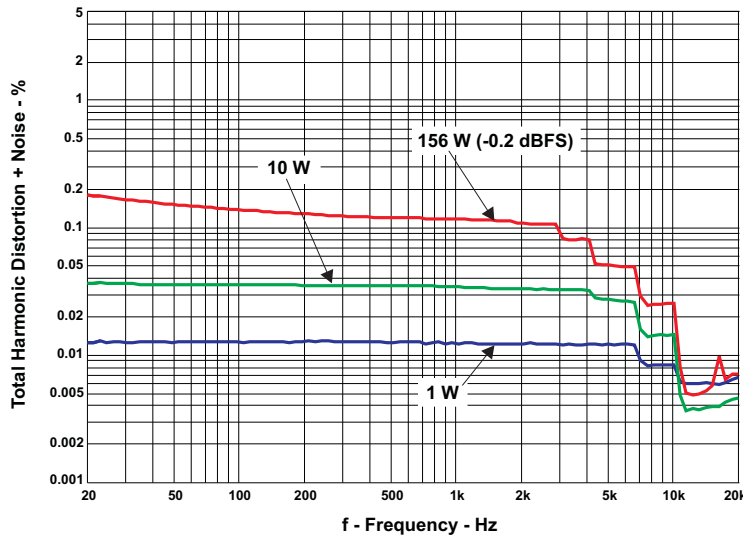

Figure 7. THD+N vs Frequency (BTL - 6Ω)

4.5 THD+N vs Frequency (BTL - 8Ω)

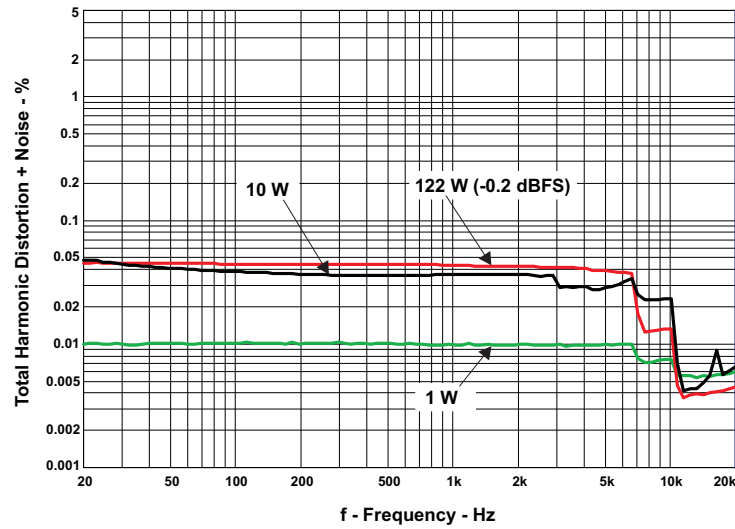

Figure 8. THD+N vs Frequency (BTL - 8Ω)

4.6 THD+N vs Frequency (PBTL - 4Ω)

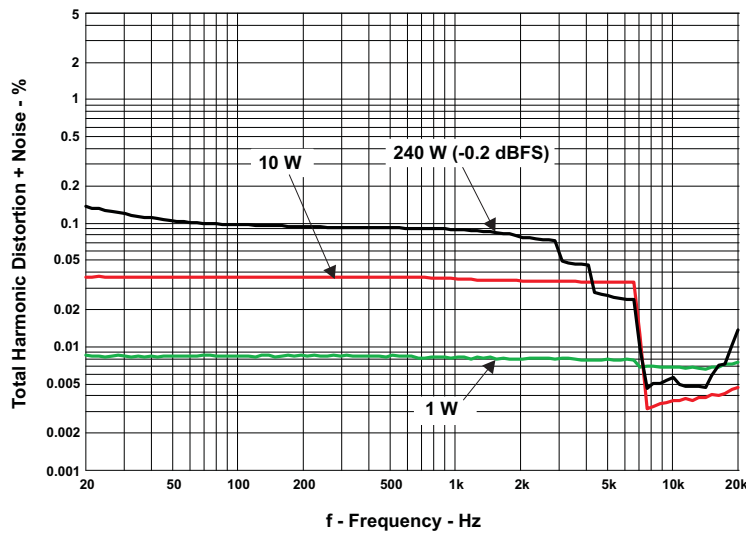

Figure 9. THD+N vs Frequency (PBTL - 4Ω)

4.7 FFT Spectrum With -60 dBFS Tone (BTL)

Reference voltage is 31.9 V. FFT size 16k.

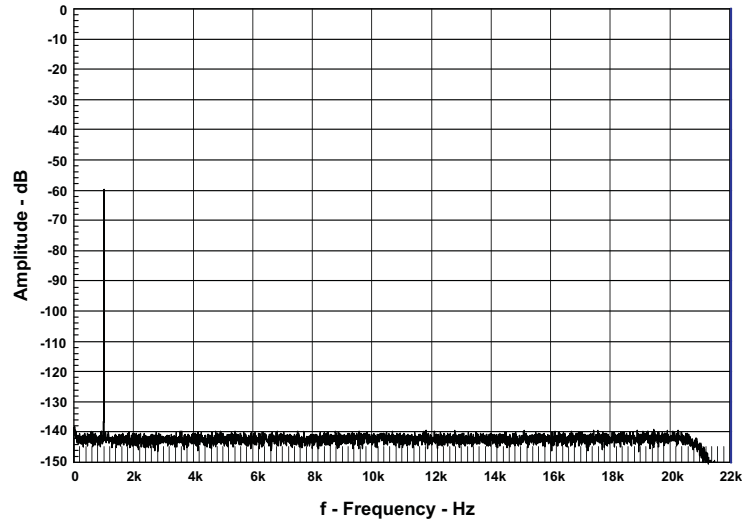

Figure 10. Figure 10. FFT Spectrum With -60 dBFS Tone (BTL)

4.8 FFT Spectrum With -60 dBFS Tone (PBTTL)

Reference voltage is 31.7 V. FFT size 16k.

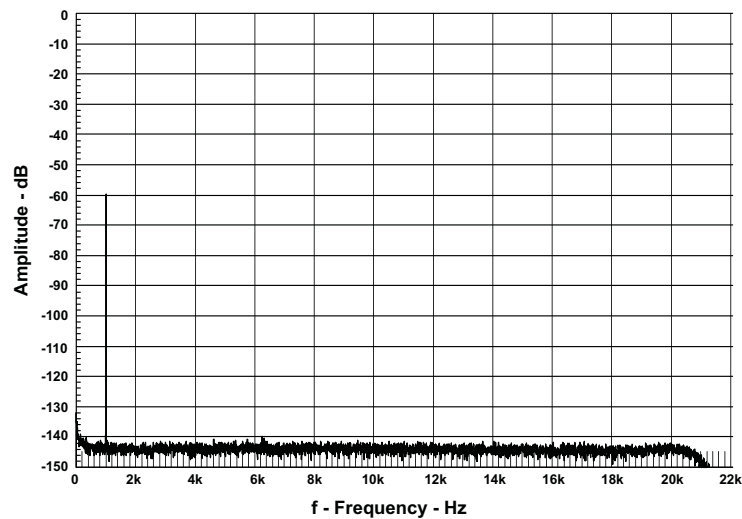

Figure 11. 4.8 FFT Spectrum With -60 dBFS Tone (PBTTL)

4.9 Idle Noise FFT Spectrum (BTL)

Automute disabled — Register x04h set to x60h. Reference voltage is 31.6 V. FFT size 16k.

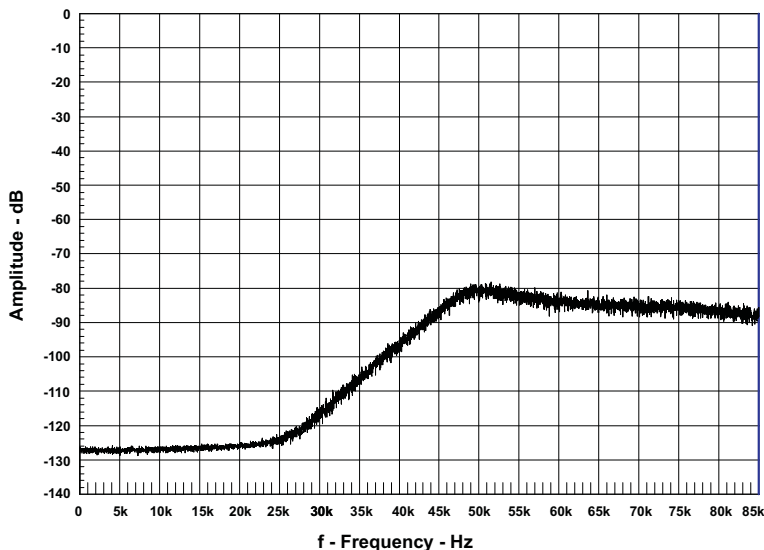

Figure 12. Idle Noise FFT Spectrum (BTL)

4.10 Idle Noise FFT Spectrum (PBTL)

Automute disabled — Register x04h set to x60h. Reference voltage is 31.6V. FFT size 16k.

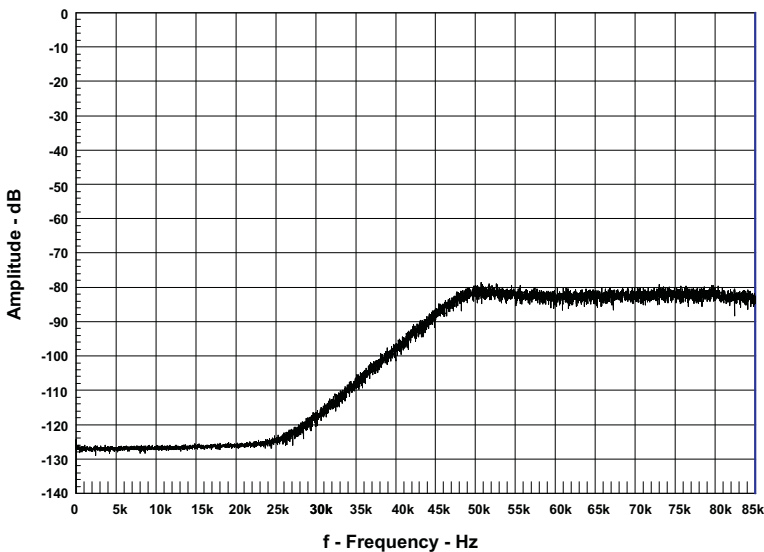

Figure 13. Idle Noise FFT Spectrum (PBTL)

4.11 Channel Separation

Channel separation is tested for two channels in different package, channel 1 and channel 2. 8 Ω loads are used for both channels. Channel 1 input signal is 0 dBFS, channel 2 muted. Reference voltage is 31.9 V_{rms}

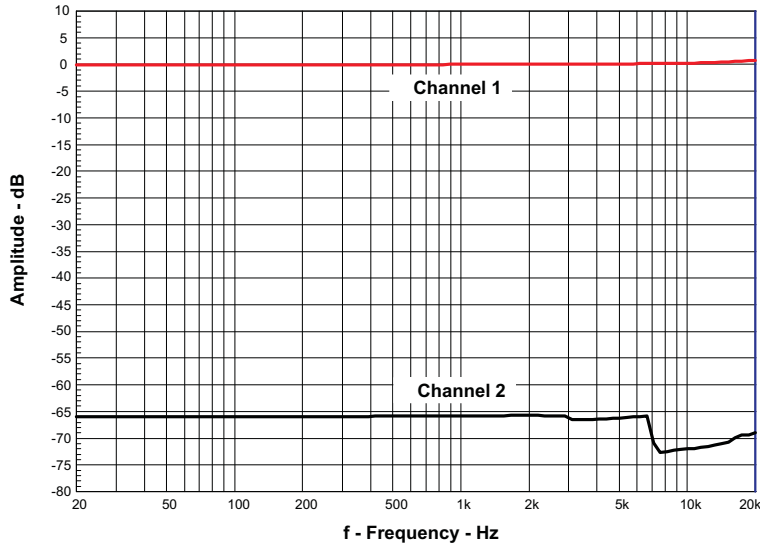

Figure 14. Channel Separation

4.12 Frequency Response (BTL)

Measurement bandwidth filter 80 kHz.

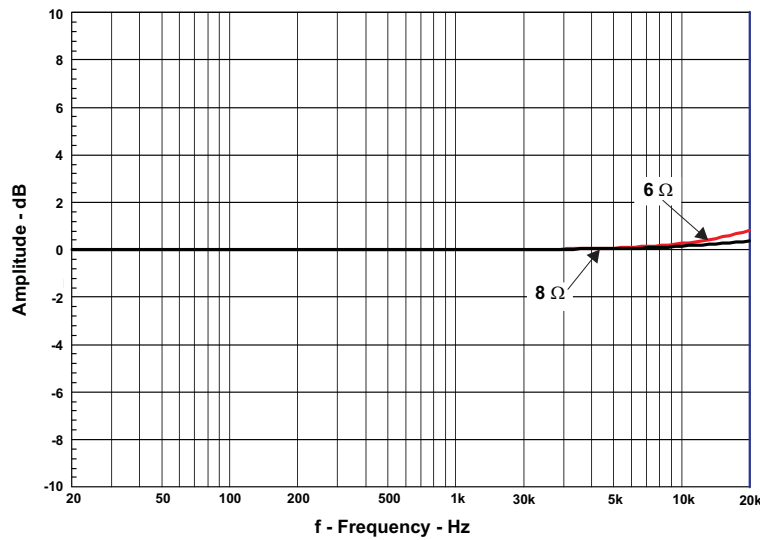

Figure 15. Frequency Response (BTL)

4.13 Frequency Response (PBTl)

Measurement bandwidth filter 80 kHz.

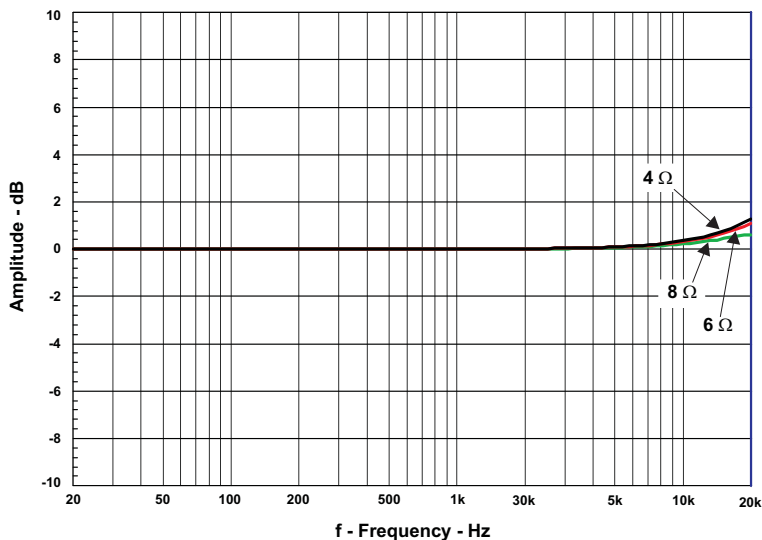

Figure 16. Frequency Response (PBTl)

4.14 High Current Protection (BTL)

Input 1 kHz bursted signal, Load 1 Ω.

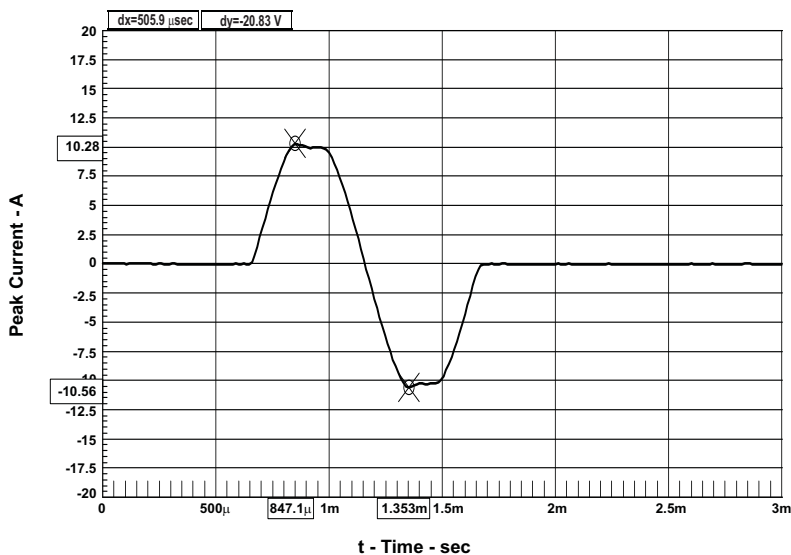

Figure 17. High Current Protection (BTL)

4.15 High Current Protection (PBTL)

Input 1 kHz bursted signal, Load 1 Ω .

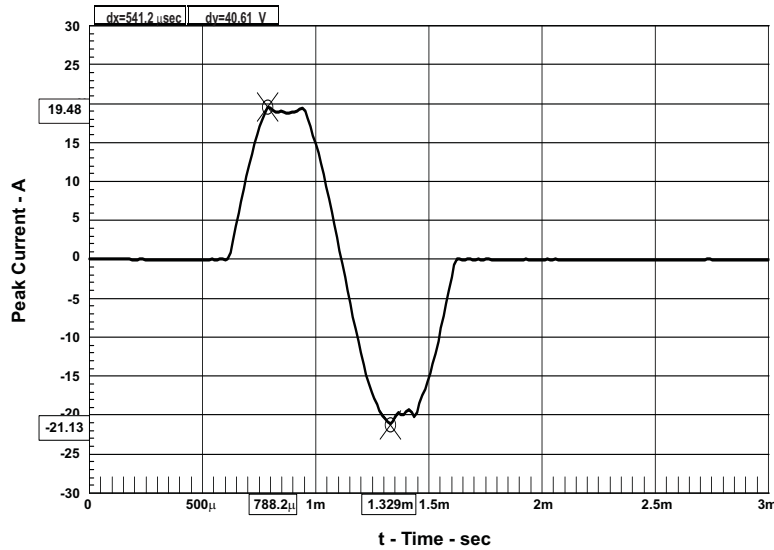

Figure 18. High Current Protection (PBTL)

4.16 Pop/Click (BTL)

No input signal applied. The measurement results are presented both in time domain and in frequency domain.

Test with automute disabled — Register x04h set to x60h. No input signal applied. Load 6 Ω .

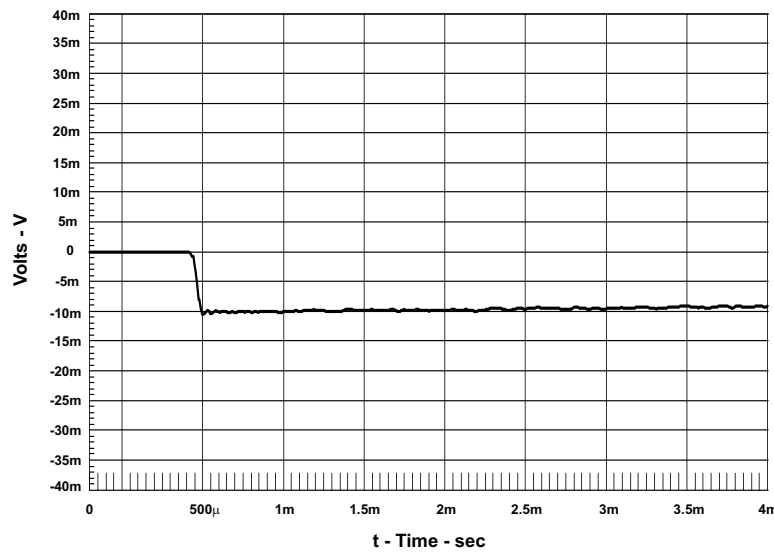

Figure 19. Pop/Click (BTL)

4.17 Pop/Click (PBTL)

No input signal applied. The measurement results are presented both in time domain and in frequency domain.

Test with automute disabled — Register x04h set to x60h. No input signal applied. Load 4 Ω.

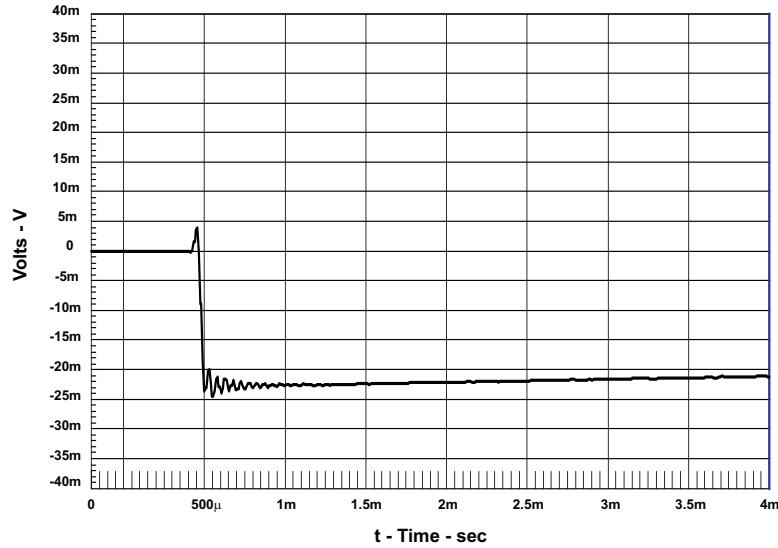

Figure 20. Pop/Click (PBTL)

4.18 Output Stage Efficiency

Efficiency is tested with 2 channels loaded 8 Ω. The board has been preheated for 1 hour at 1/8 output power.

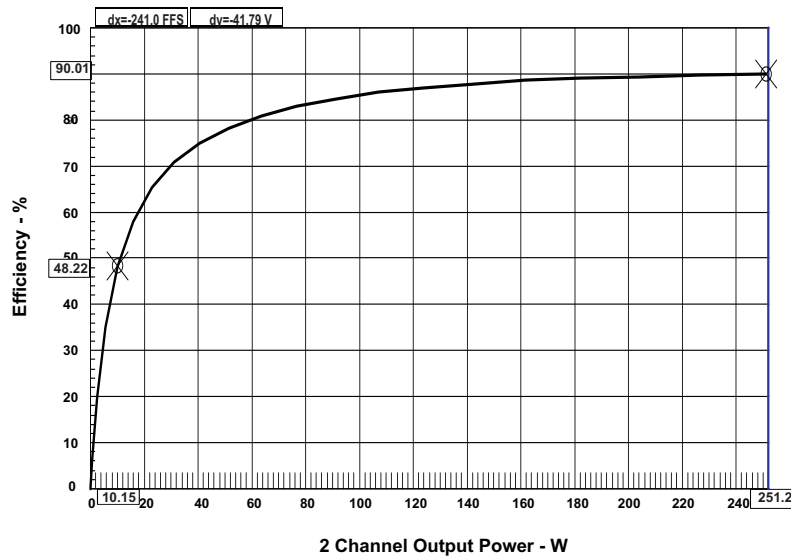

Figure 21. Output Stage Efficiency

4.19 Subwoofer Line Out THD Vs. Output Voltage

Gain: 2.5 dB set in TAS5518

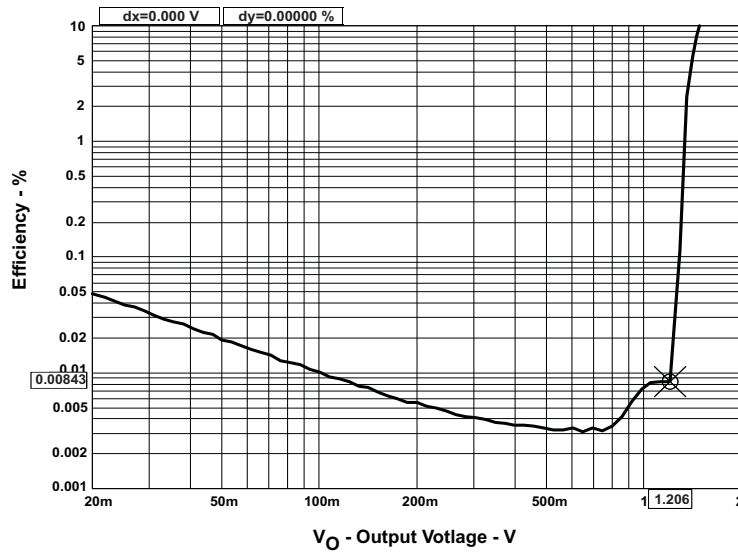

Figure 22. Subwoofer Line Out THD Vs. Output Voltage

4.20 Subwoofer Line Out THD+N vs. Frequency

Load 10 kΩ.

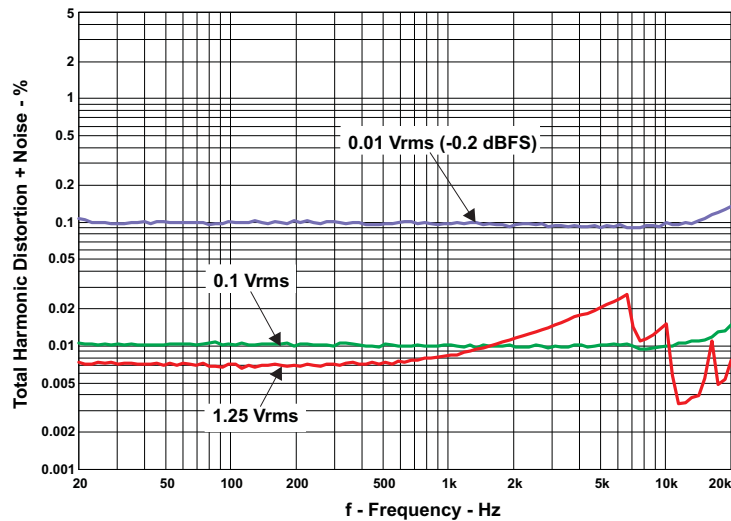

Figure 23. Subwoofer Line Out THD+N vs. Frequency

4.21 Subwoofer Line Out Frequency Response

Measurement bandwidth filter 80 kHz. Load 10 kΩ.

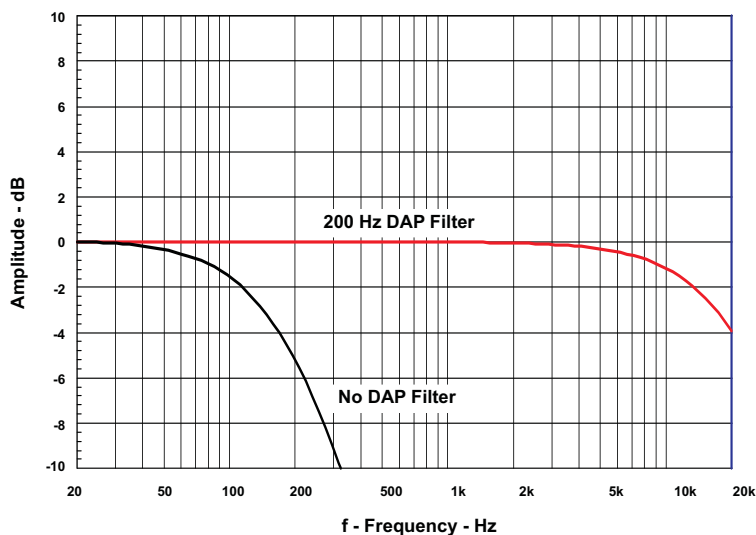

Figure 24. Subwoofer Line Out Frequency Response

5 Related Documentation from Texas Instruments

Table 11 contains a list of data manuals that have detailed descriptions of the integrated circuits used in the design of the TAS5162DDV6EVM2. The data manuals can be obtained at the <http://www.ti.com>.

Table 11. Related Documentation from Texas Instruments

Part Number	Literature Number
TAS5518	SLES115
TAS5162	SLES194
TLV272	SLOS351
TPS3825-33	SLVS165
TPS5430	SLVS632
TPS76733	SLVS208
TPS79133	SLVS325

5.1 Additional Documentation

1. PC Configuration Tool for TAS5518 (TAS5518 GUI ver. 4.0 or later)
2. System Design Considerations for True Digital Audio Power Amplifiers ([SLAA117](#))
3. Digital Audio Measurements ([SLAA114](#))
4. PSRR for PurePath Digital Audio Amplifiers ([SLEA049](#))
5. Power Rating in Audio Amplifier ([SLEA047](#))
6. PurePath Digital AM Interference Avoidance ([SLEA040](#))
7. Click & Pop Measurements Technique ([SLEA044](#))
8. Power Supply Recommendations for DVD-Receivers ([SLEA027](#))
9. Implementation of Power Supply Volume Control ([SLEA038](#))

Appendix A

A.1 Design Documents

Table A-1. Design Documents

Appendix	Document	Version	Pages
A.1	TAS5162DDV6EVM2 Schematic	Version 2.00	8 pages
A.2	TAS5162DDV6EVM2 Parts List	Version 2.00	2 pages
A.3	TAS5162DDV6EVM2 PCB Specification	Version 2.00	1 pages
A.4	TAS5162DDV6EVM2 PCB Layers	Version 2.00	6 pages
A.5	Heat Sink Drawing	Version 2.00	1 pages



Board Name: **TAS5162DDV6EVM2**
 Type: Mass Market Evaluation Module
 File Name: A829-SCH-001.DSN
 Version: 2.00
 Date: 27.April 2007
 Engineer: Jonas L. Holm

Audio Configuration: 3-6 Channel PurePath Digital Amplifier Design with Subwoofer line out
 1 x TAS5518PAG, 3 x TAS5162DDV
 1 x Subwoofer Line Out

Interfaces: J30: 34 pin IDC Header for Control, I2C and +5V
 J60: 16 pin IDC Header for I2S Audio
 J101-J108: 2 pin 3.96mm Headers for Speakers
 J600: RCA Connector for Subwoofer Line Out
 J900: 4 pin 3.96mm Header for H-Bridge Power Supply (Optional)
 J901: 4 pin 3.96mm Header for H-Bridge and System Power Supply
 J902: 5 pin 2.54mm Header for PSU Control

Setup: 8 Ohm (BTL) and 4 Ohm (PBTL) Speaker Loads
 +50V H-Bridge and +15V System Power Supplies

Performance: 125 W / 8 Ohm (BTL) unclipped, or 210 W / 6 Ohm (BTL) 10% THD+N
 110 dB Dynamic Range

Page

- 1/8: Front Page and Schematic Disclaimer
- 2/8: Overview - Modulator, Input/Output and Headphone Connectors
- 3/8: Power Stage 1
- 4/8: Power Stage 2
- 5/8: Power Stage 3
- 6/8: Subwoofer Line Out
- 7/8: Power Supplies
- 8/8: Mechanics

Copyright 2007 Texas Instruments, Inc - All rights reserved - The TI and PurePath Digital logos are trademarks of Texas Instruments.

SCHEMATIC DISCLAIMER

The preliminary schematic information and materials ("Materials") provided here are provided by Texas Instruments Incorporated ("TI") as a service to its customers and/or suppliers, and may be used for informational purposes only, and only subject to the following terms. By downloading or viewing these Materials, you are signifying your assent to these terms.

- 1.) These preliminary evaluation schematics are intended for use for PRELIMINARY ENGINEERING DEVELOPMENT AND EVALUATION PURPOSES ONLY and are not considered by Texas Instruments to be fit as a basis for establishing production products or systems. This information may be incomplete in several respects, including but not limited to information relating to required design, marketing, and/or manufacturing-related protective considerations and product safety measures typically found in the end-product incorporating the goods.
- 2.) Accordingly, neither TI nor its suppliers warrant the accuracy or completeness of the information, text, graphics, links or other items contained within the Materials. TI may make changes to the Materials, or to the products described therein, at any time without notice. TI makes no commitment to update the Materials.
- 3.) TI assumes no liability for applications assistance, customer product design, software performance, or services that may be described or referenced in the Materials. The user assumes all responsibility and liability for proper and safe design and handling of goods. Accordingly, the user indemnifies TI from all claims arising from its use of the Materials.
- 4.) TI currently deals with various customers for products, and therefore our arrangement with the user will not be exclusive. TI makes no representations regarding the commercial availability of non-TI components that may be referenced in the Materials.
- 5.) No license is granted under any patent right or other intellectual property right of TI covering or relating to any combination, machine, or process in which such TI products or services might be or are used. Except as expressly provided herein, TI and its suppliers do not grant any express or implied right to you under any patents, copyrights, trademarks, or trade secret information.
- 6.) Performance tests and ratings, to the extent referenced in the Materials, are measured using specific computer systems and/or components and reflect the approximate performance of TI products as measured by those tests. Any difference in system hardware or software design or configuration may affect actual performance. Buyers should consult other sources of information to evaluate the performance of systems or components they are considering purchasing.
- 7.) Resale of TI's products or services with statements different from or beyond the parameters stated by TI for that product or service in official TI data books or data sheets voids all express and any implied warranties for the associated TI product or service, and is an unfair and deceptive business practice, and TI is not responsible for any such use.
- 8.) The Materials are copyrighted and any unauthorized use may violate copyright, trademark, and other laws. You may only download one copy for your internal use only, unless you are specifically licensed to do otherwise by TI in writing. This is a license, not a transfer of title, and is subject to the following restrictions: You may not: (a) modify the Materials (including any associated warranties, conditions, limitations or notices) or use them for any commercial purpose, or any public display, performance, sale or rental; (b) decompile, reverse engineer, or disassemble software Materials except and only to the extent permitted by applicable law; (c) remove any copyright or other proprietary notices from the Materials; (d) transfer the Materials to another person. You agree to prevent any unauthorized copying of the Materials. TI may terminate this license at any time if you are in breach of the terms of this Agreement. Upon termination, you will immediately destroy the Materials.
- 9.) THE MATERIALS ARE PROVIDED "AS IS" WITHOUT ANY EXPRESS OR IMPLIED WARRANTY OF ANY KIND INCLUDING WARRANTIES OF MERCHANTABILITY, NONINFRINGEMENT OF INTELLECTUAL PROPERTY, OR FITNESS FOR ANY PARTICULAR PURPOSE. IN NO EVENT SHALL TI OR ITS SUPPLIERS BE LIABLE FOR ANY DAMAGES WHATSOEVER (INCLUDING, WITHOUT LIMITATION, DAMAGES FOR LOSS OF PROFITS, BUSINESS INTERRUPTION, LOSS OF INFORMATION) ARISING OUT OF THE USE OF OR INABILITY TO USE THE MATERIALS, EVEN IF TI HAS BEEN ADVISED OF THE POSSIBILITY OF SUCH DAMAGES.

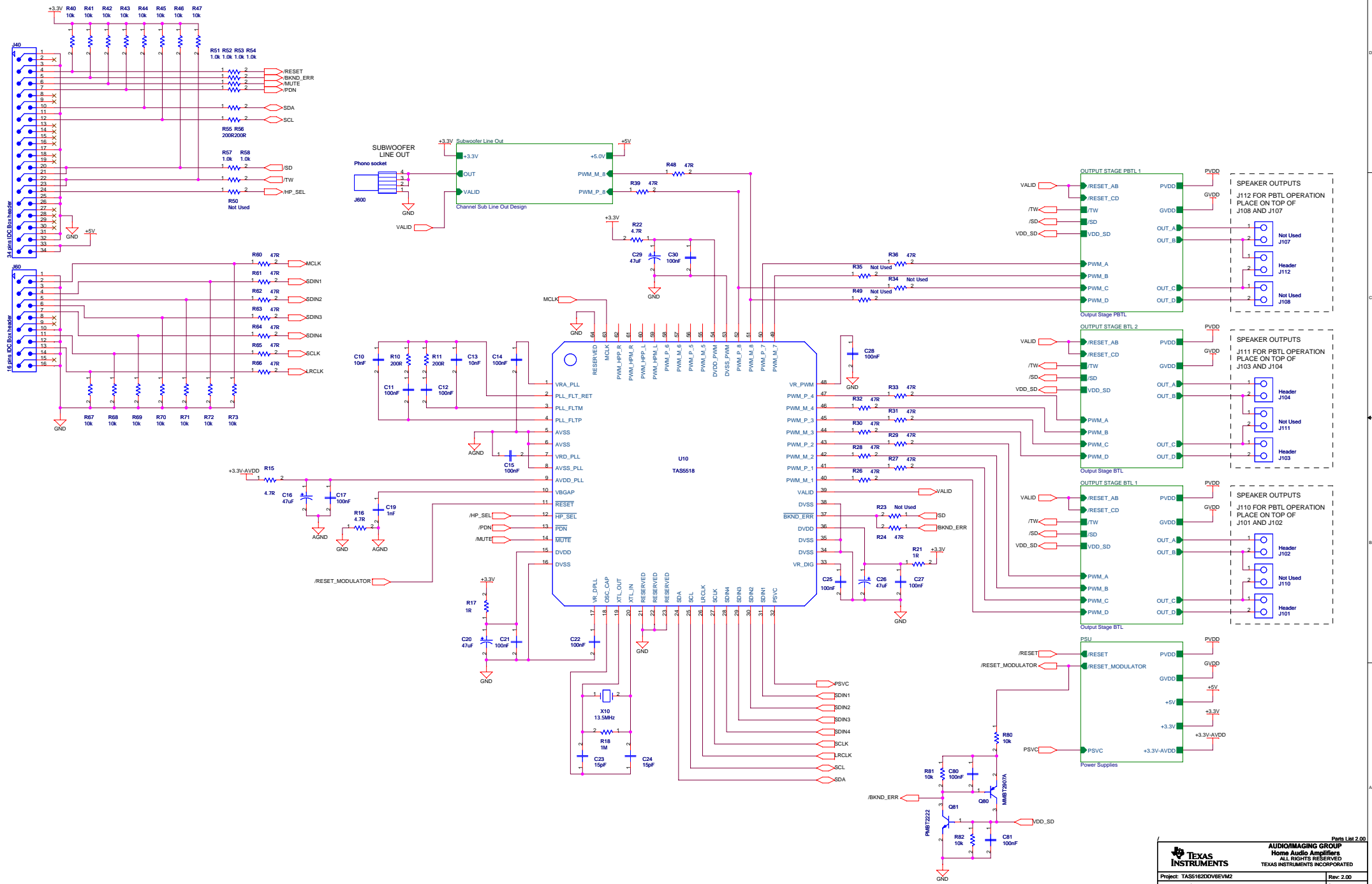

POWER OUTPUT STAGE BTL

LAYOUT NOTE:
PLACE 2x1uF AS CLOSE AS POSSIBLE
TO Ux00.

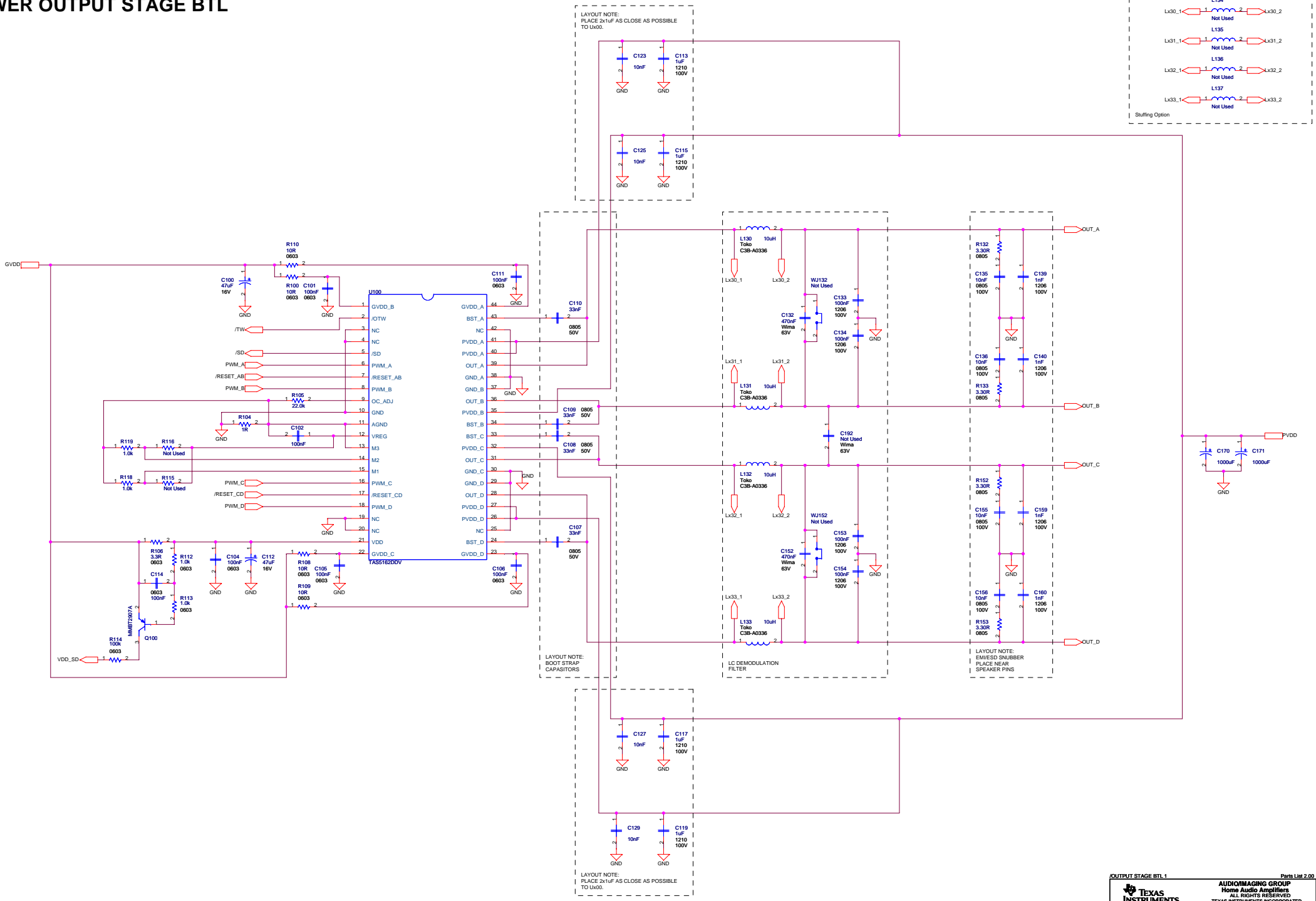
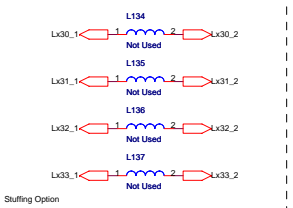

LAYOUT NOTE:
BOOT STRAP
CAPACITORS

LC DEMODULATION
FILTER

LAYOUT NOTE:
EMI/ESD SNUBBER
PLACE NEAR
SPEAKER PINS

LAYOUT NOTE:
PLACE 2x1uF AS CLOSE AS POSSIBLE
TO Ux00.

OUTPUT STAGE BTL 1		Parts List 2.00	
		AUDIOIMAGING GROUP Home Audio Amplifiers ALL RIGHTS RESERVED TEXAS INSTRUMENTS INCORPORATED	
		Project: PROJECT	Rev: 2.00
Page Title: PAGE TITLE	Size: A2	File Name: A029-SC01-001.DSN	Engineer: ENGINEER
Date: Monday, April 30, 2007			Page: 3 of 8

POWER OUTPUT STAGE PBTL

LAYOUT NOTE:
PLACE 2x1uF AS CLOSE AS POSSIBLE
TO Ux00.

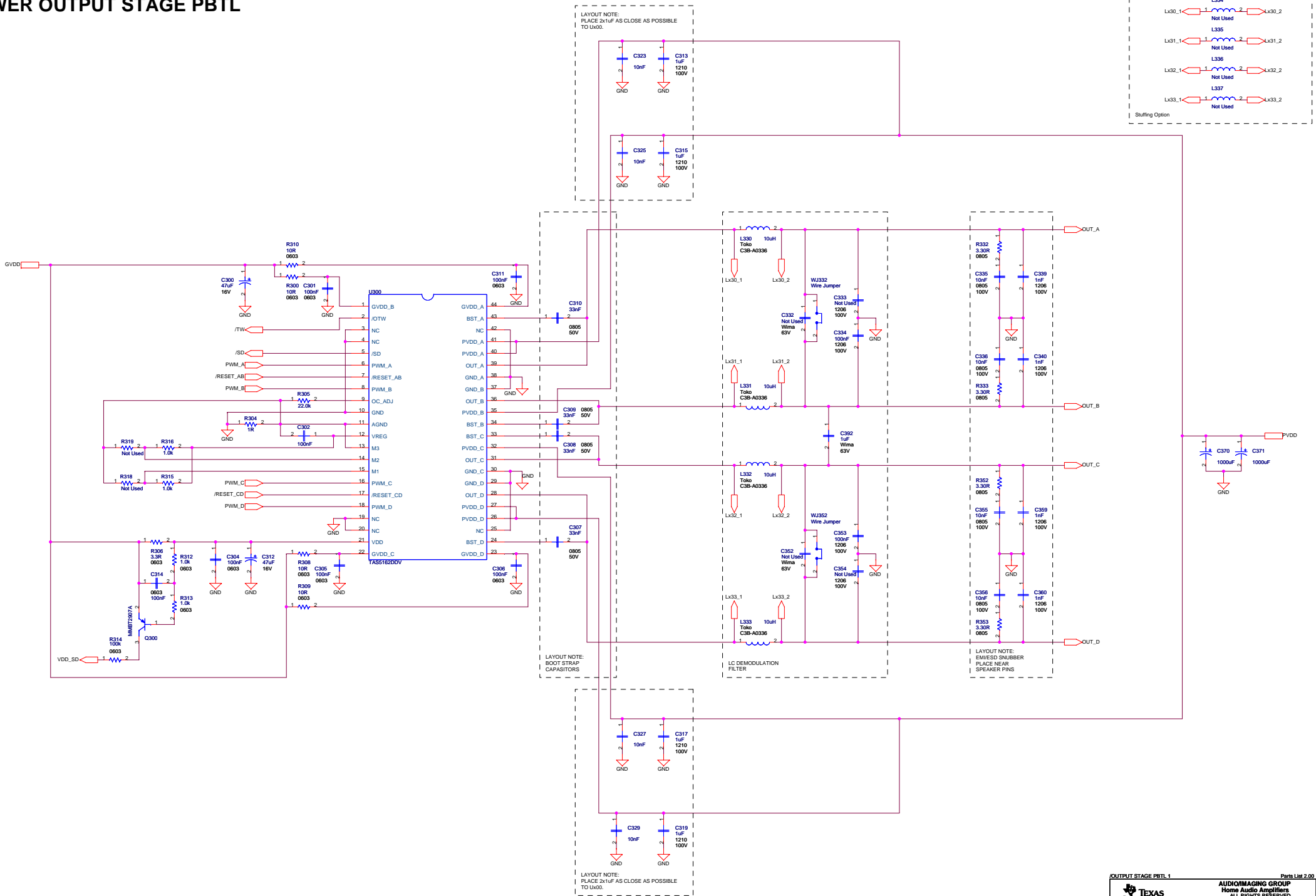
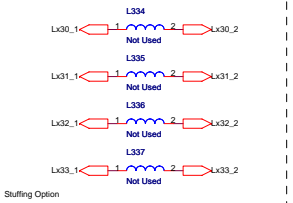

LAYOUT NOTE:
BOOT STRAP
CAPACITORS

LC DEMODULATION
FILTER

LAYOUT NOTE:
EMI/ESD SNUBBER
PLACE NEAR
SPEAKER PINS

LAYOUT NOTE:
PLACE 2x1uF AS CLOSE AS POSSIBLE
TO Ux00.

OUTPUT STAGE PBTL.1		Parts List 2.00	
		AUDIOIMAGING GROUP Home Audio Amplifiers ALL RIGHTS RESERVED TEXAS INSTRUMENTS INCORPORATED	
		Project: PROJECT	Rev: 2.00
Page Title: PAGE TITLE	Size: A2	File Name: A029-SC04-001.DSN	Engineer: ENGINEER
Date: Monday, April 30, 2007			Page: 5 of 8

SUBWOOFER LINE OUT

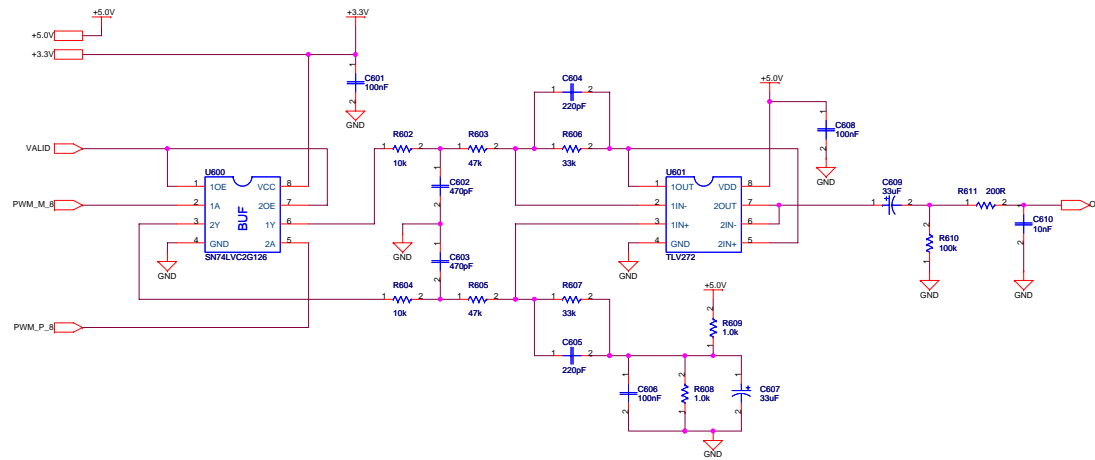

POWER SUPPLIES

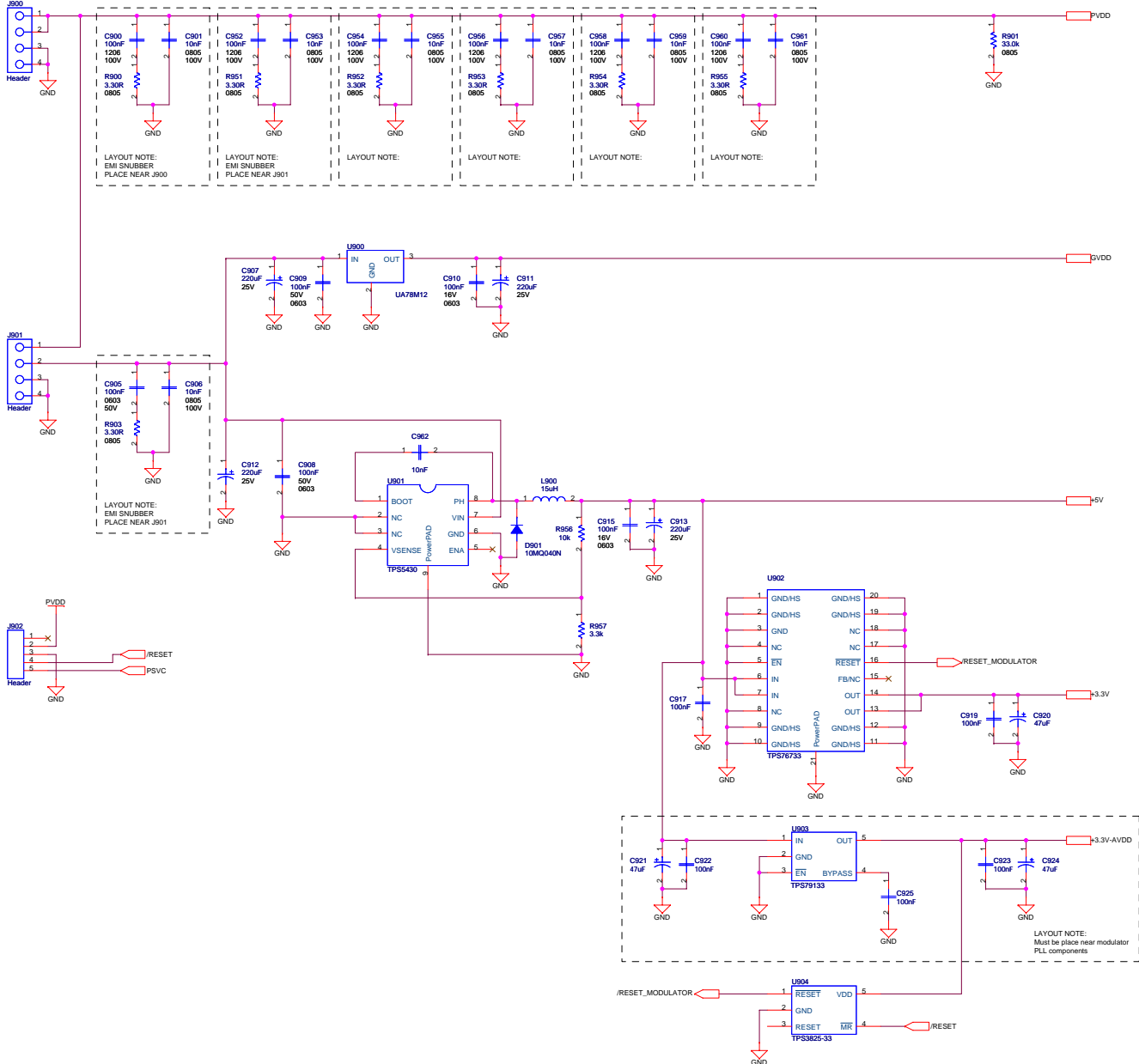

MECHANICS

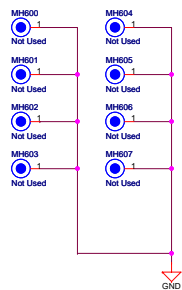
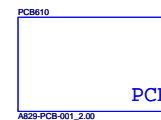
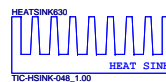
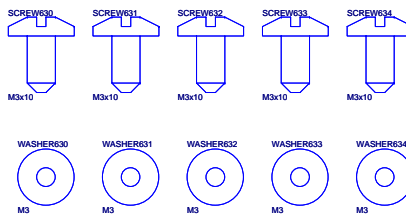
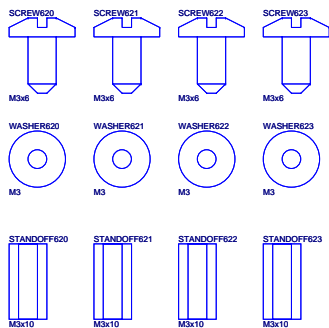

TAS5162DDV6EVM2 Partslist (2.00).xls



Qty	Part Reference	Description	Manufacture	First Mfr P/N
1	R901	33.0k / 125mW / 1% / 0805 Thick Film Resistor	Yageo	RC0805FR-0733KL
19	R132 R133 R152 R153 R232 R233 R252 R253 R332 R333 R352 R353 R900 R903 R951 R952 R953 R954 R955	3.30R / 125mW / 1% / 0805 Thick Film Resistor	Yageo	RC0805FR-073R3L
20	R51 R52 R53 R54 R57 R58 R112 R113 R118 R119 R212 R213 R218 R219 R312 R313 R315 R316 R608 R609	1.0k / 100mW / 5% / 0603 Thick Film Resistor	Yageo	RC0603JR-071KL
21	R40 R41 R42 R43 R44 R45 R46 R47 R67 R68 R69 R70 R71 R72 R73 R80 R81 R82 R602 R604 R956	10k / 100mW / 5% / 0603 Thick Film Resistor	Yageo	RC0603JR-0710KL
4	R114 R214 R314 R610	100k / 100mW / 5% / 0603 Thick Film Resistor	Yageo	RC0603JR-07100KL
1	R18	1M / 100mW / 5% / 0603 Thick Film Resistor	Yageo	RC0603JR-071ML
5	R17 R21 R104 R204 R304	1R / 100mW / 5% / 0603 Thick Film Resistor	Yageo	RC0603JR-071RL
12	R100 R108 R109 R110 R200 R208 R209 R210 R300 R308 R309 R310	10R / 100mW / 5% / 0603 Thick Film Resistor	Yageo	RC0603JR-0710RL
5	R10 R11 R55 R56 R611	200R / 100mW / 5% / 0603 Thick Film Resistor	Yageo	RC0603JR-07200RL
3	R105 R205 R305	22.0k / 100mW / 1% / 0603 Thick Film Resistor	Yageo	RC0603FR-0722KL
1	R957	3.3k / 100mW / 5% / 0603 Thick Film Resistor	Yageo	RC0603JR-073K3L
2	R606 R607	33k / 100mW / 5% / 0603 Thick Film Resistor	Yageo	RC0603JR-0733KL
3	R106 R206 R306	3.3R / 100mW / 5% / 0603 Thick Film Resistor	Yageo	RC0603JR-073R3L
2	R603 R605	47k / 100mW / 5% / 0603 Thick Film Resistor	Yageo	RC0603JR-0747KL
3	R15 R16 R22	4.7R / 100mW / 5% / 0603 Thick Film Resistor	Yageo	RC0603JR-074R7L
19	R24 R26 R27 R28 R29 R30 R31 R32 R33 R36 R39 R48 R60 R61 R62 R63 R64 R65 R66	47R / 100mW / 5% / 0603 Thick Film Resistor	Yageo	RC0603JR-0747RL
31	C123 C125 C127 C129 C135 C136 C155 C156 C223 C225 C227 C229 C235 C236 C255 C256 C323 C325 C327 C329 C335 C336 C355 C356 C901 C906 C953 C955 C957 C959 C961	Ceramic 10nF / 100V / 20% X7R 0805 Capacitor	BC Components	0805B103M101NT
12	C107 C108 C109 C110 C207 C208 C209 C210 C307 C308 C309 C310	Ceramic 33nF / 50V / 20% X7R 0805 Capacitor	BC Components	0805B333M500NT
12	C139 C140 C159 C160 C239 C240 C259 C260 C339 C340 C359 C360	Ceramic 1nF / 100V / 10% NP0 1206 Capacitor	BC Components	1206N102K101NT
16	C133 C134 C153 C154 C233 C234 C253 C254 C334 C353 C900 C952 C954 C956 C958 C960	Ceramic 100nF / 100V / 20% X7R 1206 Capacitor	BC Components	1206B104M101NT
12	C113 C115 C117 C119 C213 C215 C217 C219 C313 C315 C317 C319	Ceramic 1uF / 100V / 10% X7R 1210 Capacitor	Murata	GRM32ER72A105KA01L
4	C10 C13 C610 C962	Ceramic 10nF / 50V / 20% X7R 0603 Capacitor	Vishay	VJ0603Y103MXA
44	C11 C12 C14 C15 C17 C21 C22 C25 C27 C28 C30 C80 C81 C101 C102 C104 C105 C106 C111 C114 C201 C202 C204 C205 C206 C211 C214 C301 C302 C304 C305 C306 C311 C314 C601 C606 C608 C910 C915 C917 C919 C922 C923 C925	Ceramic 100nF / 16V / 20% X7R 0603 Capacitor	Vishay	VJ0603Y104MXJ
3	C905 C908 C909	Ceramic 100nF / 50V / 20% X7R 0603 Capacitor	Vishay	VJ0603Y104MXA
1	C19	Ceramic 1nF / 50V / 10% NP0 0603 Capacitor	BC Components	0603N102K500NT
2	C23 C24	Ceramic 15pF / 50V / 10% NP0 0603 Capacitor	BC Components	0603N150K500NT
2	C604 C605	Ceramic 220pF / 50V / 10% NP0 0603 Capacitor	BC Components	0603N221K500NT
2	C602 C603	Ceramic 470pF / 50V / 10% NP0 0603 Capacitor	BC Components	0603N471K500NT
6	C170 C171 C270 C271 C370 C371	Electrolytic 1000uF / 63V / 20% Aluminium 7.5mm ø16mm FC Series - Low Impedance Capacitor	Panasonic	EEUFC1J102
4	C907 C911 C912 C913	Electrolytic 220uF / 25V / 20% Aluminium 3.5mm ø8mm FC Series - Low Impedance Capacitor	Panasonic	EEUFC1E221
2	C607 C609	Electrolytic 33uF / 16V / 20% Aluminium 2mm ø5mm Capacitor	Panasonic	ECEA1CKA330
13	C16 C20 C26 C29 C100 C112 C200 C212 C300 C312 C920 C921 C924	Electrolytic 47uF / 16V / 20% Aluminium 2mm ø5mm FC Series - Low Impedance Capacitor	Panasonic	EEUFC1C470
1	C392	Metal Film 1uF / 63V / 10% Polyester 7.5mm (W:6mm L:10mm) Capacitor	Wima	MKS 4 1uF/10%/63Vdc PCM7.5
4	C132 C152 C232 C252	Metal Film 470nF / 63V / 10% Polyester 7.5mm (W:4.5mm L:10mm) Capacitor	Wima	MKS 4 0.47uF/10%/63Vdc PCM7.5
12	L130 L131 L132 L133 L230 L231 L232 L233 L330 L331 L332 L333	10uH / Ferrite Inductor	Toko	C3B-A0336
1	L900	15uH / Ferrite Inductor	Kwang Sung	8020P-06-150L
2	WJ332 WJ352	Wire Jumper / Wire ø0.9mm (SWG20), Pitch 7.5mm, Copper Tinned Wire Jumper Inductor	n/a	n/a
1	D901	1A / 40V Schottky 10MQ040N Diode (SMA) 600mA / 40V NPN Small signal PMBT2222	Int. Rectifier	10MQ040N
1	Q81	Transistor (SOT-23) 800mA / 40V PNP Small signal MMBT2907A	Philips	PMBT2222
4	Q80 Q100 Q200 Q300	Transistor (SOT-23)	Fairchild	MMBT2907A
3	U100 U200 U300	TAS5162DDV / 4ch/2ch/1ch Digital Audio PWM Power Output Stage (DDV44)	Texas Instruments	TAS5162DDV
1	U10	TAS5518 / 8 ch PWM processor (AD, DAP, 192kHz, PWM-VOL) (TQFP64)	Texas Instruments	TAS5518PAG
1	U601	TLV272 / Dual RtR Output Opamp (VSSOP8)	Texas Instruments	TLV272CDGK

TAS5162DDV6EVM2 Partslist (2.00).xls



1	U600	SN74LVC2G126 / Dual Buffer, LVC (SSOP8)	Texas Instruments	SN74LVC2G126DCT
1	U904	TPS3825-33 / 3.3V Supply Voltage Supervisor (SOP5-DBV)	Texas Instruments	TPS3825-33DBVT
1	U900	UA78M12 / 12V/500mA Positive Voltage Regulator (PFM2-KTP)	Texas Instruments	UA78M12CKTPR
1	U901	TPS5430 / 5V/3A Buck Converter (HSOP8-DDA)	Texas Instruments	TPS5430DDA
1	U902	TPS76733 / 3.3V/1A Low Drop Voltage Regulator (HTSSOP20-PWP)	Texas Instruments	TPS76733QPWP
1	U903	TPS79133 / 3.3V/100mA Low Dropout Regulator (Ultra Low Noise) (SOP5-DBV)	Texas Instruments	TPS79133DBVR
4	SCREW620 SCREW621 SCREW622 SCREW623	M3x6 Pan Head, Pozidriv, A2 Screw	Bossard	BN 81882 M3x6
5	SCREW630 SCREW631 SCREW632 SCREW633 SCREW634	M3x10 Pan Head, Pozidriv, A2 Screw	Bossard	BN 81882 M3x10
4	WASHER620 WASHER621 WASHER622 WASHER623	M3 Stainless Steel Washer	Bossard	BN 670 M3
5	WASHER630 WASHER631 WASHER632 WASHER633 WASHER634	M3 Stainless Steel Spring Washer	Bossard	BN 760 M3
4	STANDOFF620 STANDOFF621 STANDOFF622 STANDOFF623	M3x10 Aluminium Stand-off	Ettinger	05.03.108
1	J902	5 pins / 1 row / 2.54mm Pitch Vertical Male Friction lock Pin header Header	Molex	22-27-2051
5	J101 J102 J103 J104 J112	2 pins / 1 row / 3.96mm Pitch Vertical Male Pin header Header	JST	B2P-VH
2	J900 J901	4 pins / 1 row / 3.96mm Pitch Vertical Male Pin header Header	JST	B4P-VH
1	J600	Horizontal Female w. Switch Coax Phono socke	Chunfeng	RJ843-4W
1	J60	16 pins / 2 rows / 2.54mm Pitch Vertical Male IDC 16 pins IDC Box header	Molex	87256-1611
1	J40	34 pins / 2 rows / 2.54mm Pitch Vertical Male IDC 34 pins IDC Box header	Molex	87256-3411
1	X10	13.5MHz 13.5MHz SMD Crystal (HCM49)	Citizen	HCM49-13.500MABJT
1	PCB610	A829-PCB-001_2.00 / TAS5162DDV6EVM2 Printed Circuit Board (ver. 2.00)	Printline	A829-PCB-001(2.00)
1	HEATSINK630	TIC-HSINK-048_2.00 / Heatsink for 3 DDV packages length 154mm	THF-Teknik	TIC-HSINK-048(2.00)

TAS5162DDV6EVM2

PCB SPECIFICATION

Version 2.00

BOARD IDENTIFICATION:	A829-PCB-001(2.00)
BOARD TYPE:	DOUBLE-SIDED PLATED-THROUGH BOARD
LAMINATE TYPE:	FR4
LAMINATE THICKNESS:	1.6mm
COPPER THICKNESS:	70 μ m (INCL. PLATING EXTERIOR LAYER)
COPPER PLATING OF HOLES:	>25 μ m
MINIMUM HOLE DIAMETER	0.3 mm
SILKSCREEN COMPONENT SIDE:	WHITE - REMOVE SILKSCREEN FROM SOLDER AREA & PRE-TINNED AREAS
SILKSCREEN SOLDER SIDE:	None
SOLDER MASK COMPONENT SIDE:	GREEN
SOLDER MASK SOLDER SIDE:	GREEN
PROTECTIVE COATING:	SOLDER COATING AND CHEMICAL SILVER ON FREE COPPER
ELECTRICAL TEST:	PCB MUST BE ELECTRICAL TESTED
MANUFACTURED TO:	PERFAG 2E (www.perfag.dk)
APERTURE TABLE:	PERFAG 10A (www.perfag.dk)
BOARD SIZE:	160 x 171.5 mm
Aprox. Number of holes	1200
COMMENTS:	SEE DRILL INFORMATION FILE (pdfdoc\FAB1_DRAWING.pdf).

POS	Texas Instruments Lyngby Hovedgade 4, DK-2800 Lyngby		
	Title TAS5162DDV6EVM2	Date 2007/MAY/03	
	P/N A829-PCB-001-2.00	REV 1	Designer KR
	LAYER 01 - SHEET 01 OF 07	Engineer Jonas Holm	

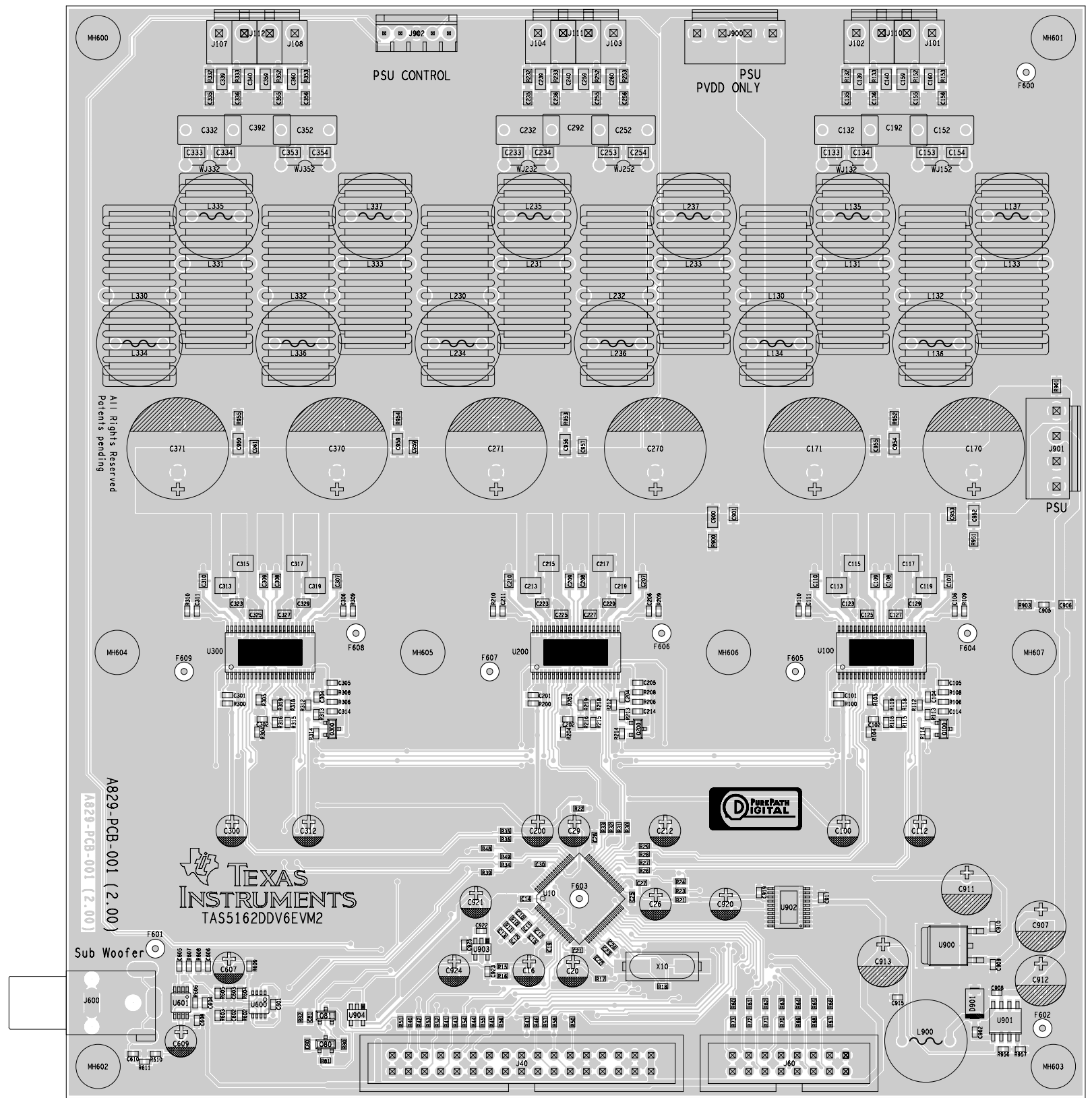

RevNo	Revision note	Date	Signature	Checked
1	INITIAL RELEASE	2007/MAY/03	KR	CMS

NOTES: UNLESS OTHERWISE SPECIFIED.

1. COMPONENT MOUNTING TYPES TOP/BOTTOM : SMD-Leaded / SMD.
2. X,Y COORDINATES AND ROTATION PROVIDED IN DATA FILES.
3. SOLDERING METHODS TYPE TOPSIDE : RES
4. SOLDERING METHODS TYPE BOTSIDE : RES / WAS
WAS - Wave soldering
RES - Reflow soldering
IRS - Infrared soldering
MHS - Manual hand-soldering
5. PCBLAYOUT BY GHDSIGN DENMARK. (+45)44441482
6. PCB CONTAINS BGA AND NSMD LEADLESS PACKAGES.

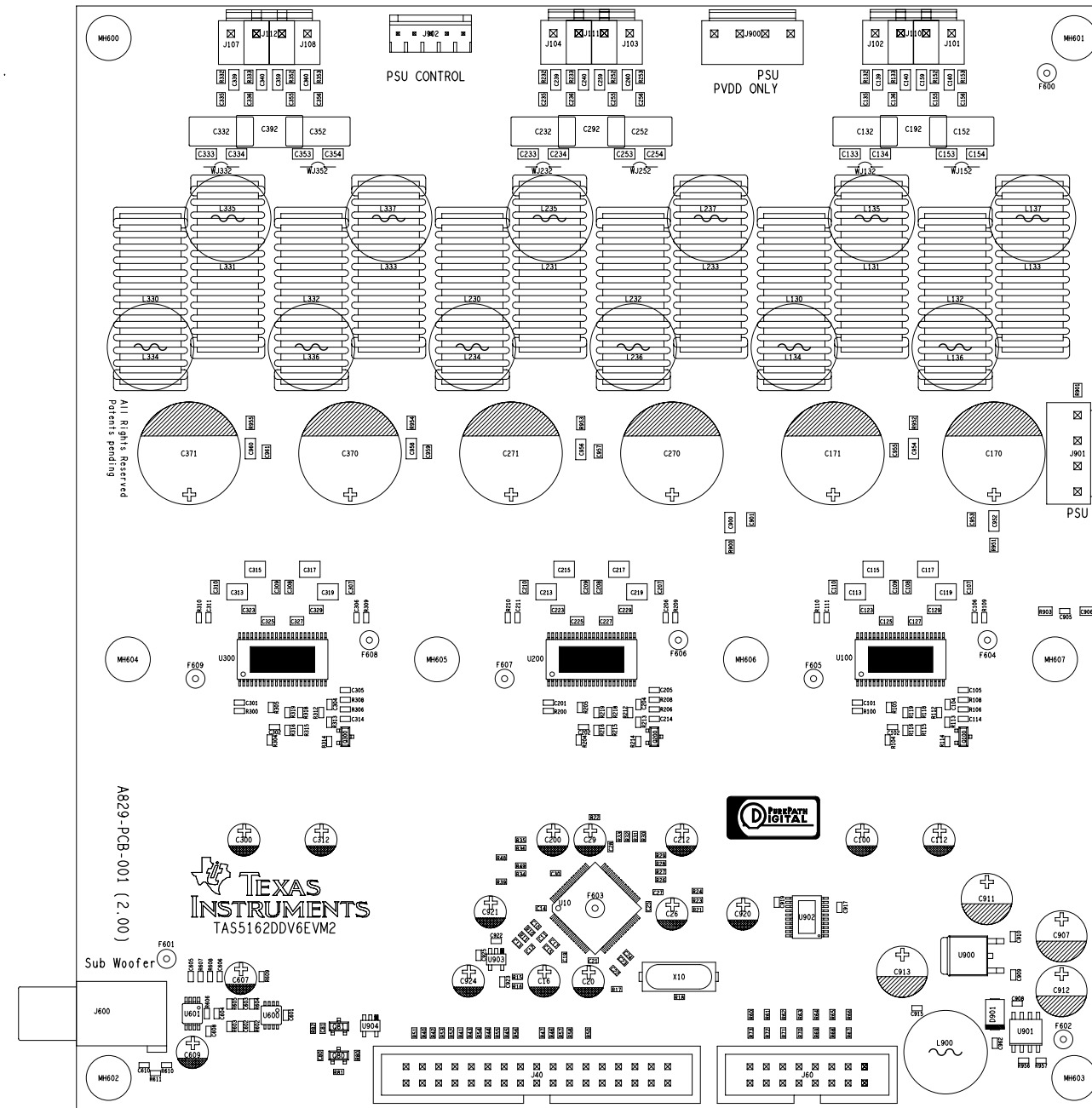

POS	Texas Instruments		
	Lyngby Hovedgade 4, DK-2800 Lyngby		
	Title TAS5162DDV6EVM2	Date 2007/MAY/03	
	P/N A829-PCB-001-2.00	REV 1	Designer KR
LAYER 01 - SHEET 01 OF 07		Engineer Jonas Holm	

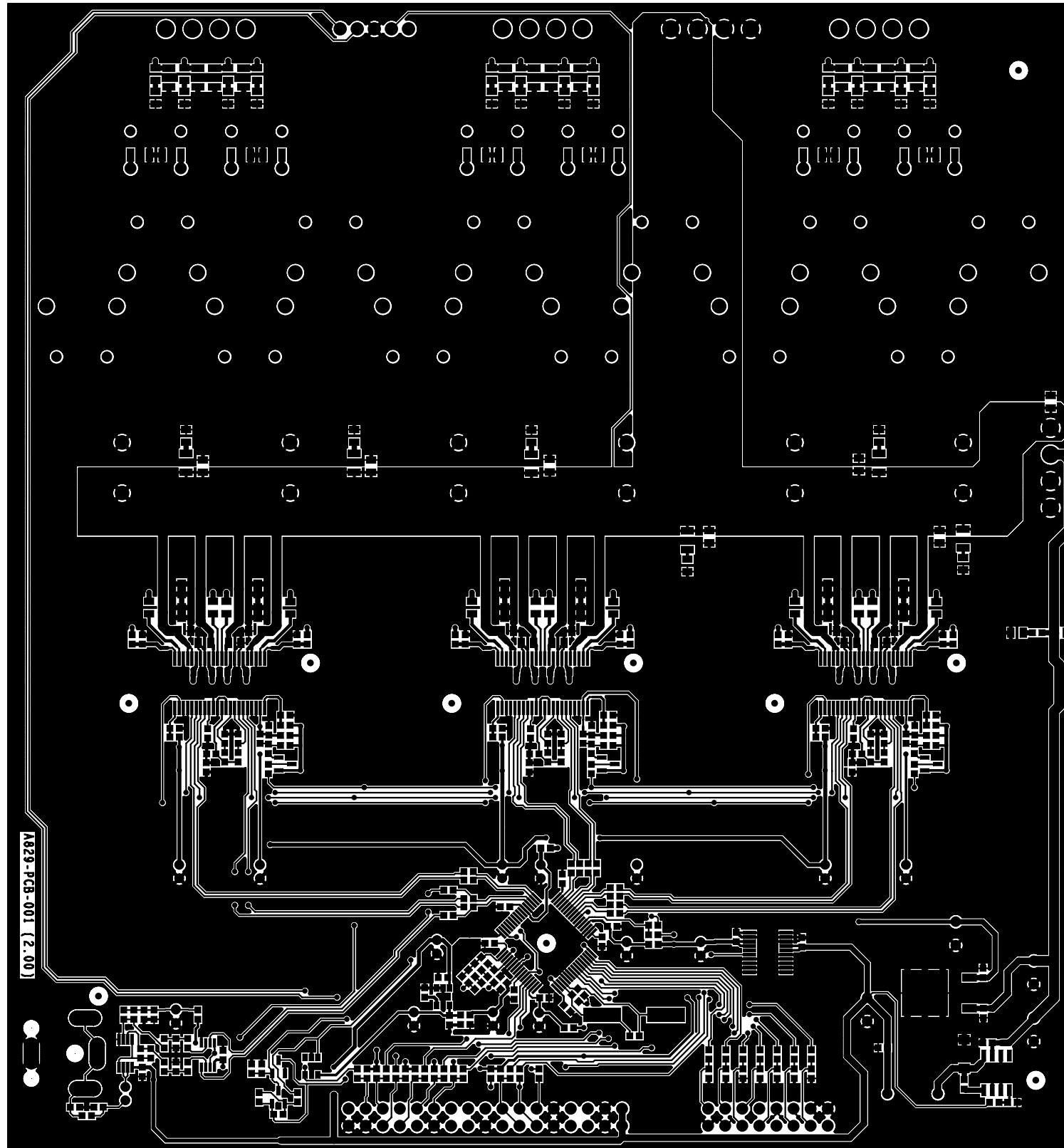

POS	Texas Instruments Lyngby Hovedgade 4, DK-2800 Lyngby		
	Title TAS5162DDV6EVM2	Date 2007/MAY/03	
	P/N A829-PCB-001-2.00	REV 1	Designer KR
	LAYER 02 - SHEET 02 OF 07	Engineer Jonas Holm	

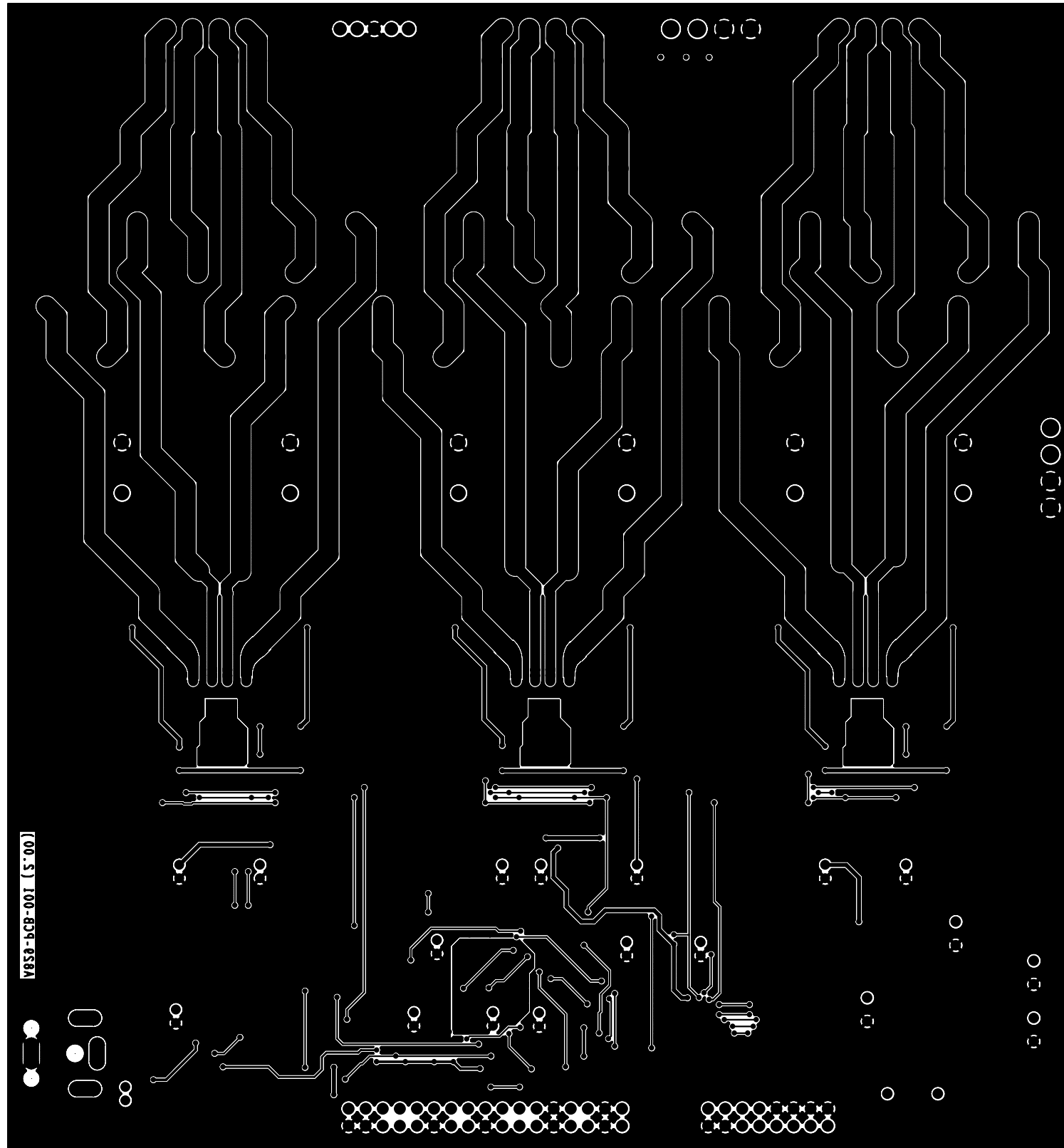

TIC-HSINK-048(2.00)

Heatsink for 3 DDV packages

Jonas L. Holm

7.May.2007
TIC-HSINK-048(2.00).dwg

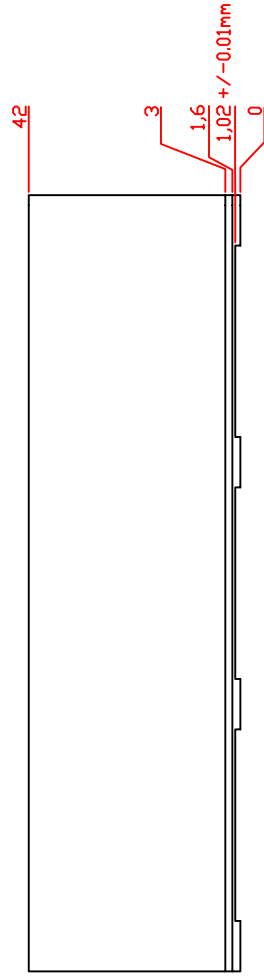
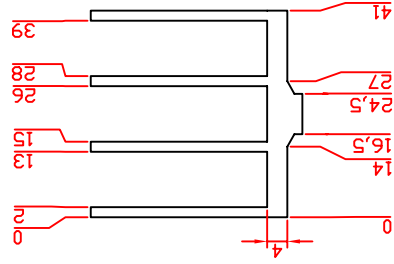
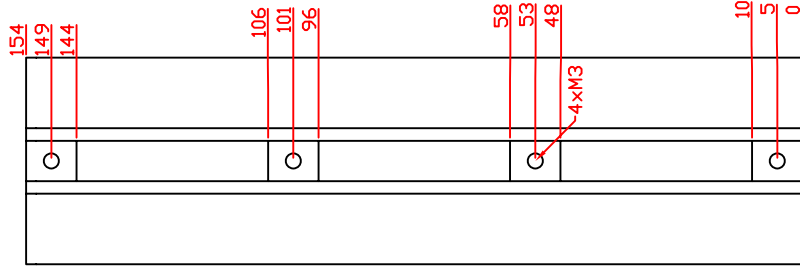

SCALE: 1:1.5
PROFILE: TIC-HSINK-050(1.00)
DIMENSIONS: mm
MATERIAL: ALUMINUM
INTERNAL SCREW THREADS: M3
SURFACE: FREE OF SHARP EDGES
SURFACE TREATMENT: BLACK ANODIZED
TOLERANCES: +/- 0.1 mm

EVALUATION BOARD/KIT IMPORTANT NOTICE

Texas Instruments (TI) provides the enclosed product(s) under the following conditions:

This evaluation board/kit is intended for use for **ENGINEERING DEVELOPMENT, DEMONSTRATION, OR EVALUATION PURPOSES ONLY** and is not considered by TI to be a finished end-product fit for general consumer use. Persons handling the product(s) must have electronics training and observe good engineering practice standards. As such, the goods being provided are not intended to be complete in terms of required design-, marketing-, and/or manufacturing-related protective considerations, including product safety and environmental measures typically found in end products that incorporate such semiconductor components or circuit boards. This evaluation board/kit does not fall within the scope of the European Union directives regarding electromagnetic compatibility, restricted substances (RoHS), recycling (WEEE), FCC, CE or UL, and therefore may not meet the technical requirements of these directives or other related directives.

Should this evaluation board/kit not meet the specifications indicated in the User's Guide, the board/kit may be returned within 30 days from the date of delivery for a full refund. **THE FOREGOING WARRANTY IS THE EXCLUSIVE WARRANTY MADE BY SELLER TO BUYER AND IS IN LIEU OF ALL OTHER WARRANTIES, EXPRESSED, IMPLIED, OR STATUTORY, INCLUDING ANY WARRANTY OF MERCHANTABILITY OR FITNESS FOR ANY PARTICULAR PURPOSE.**

The user assumes all responsibility and liability for proper and safe handling of the goods. Further, the user indemnifies TI from all claims arising from the handling or use of the goods. Due to the open construction of the product, it is the user's responsibility to take any and all appropriate precautions with regard to electrostatic discharge.

EXCEPT TO THE EXTENT OF THE INDEMNITY SET FORTH ABOVE, NEITHER PARTY SHALL BE LIABLE TO THE OTHER FOR ANY INDIRECT, SPECIAL, INCIDENTAL, OR CONSEQUENTIAL DAMAGES.

TI currently deals with a variety of customers for products, and therefore our arrangement with the user **is not exclusive**.

TI assumes **no liability for applications assistance, customer product design, software performance, or infringement of patents or services described herein.**

Please read the User's Guide and, specifically, the Warnings and Restrictions notice in the User's Guide prior to handling the product. This notice contains important safety information about temperatures and voltages. For additional information on TI's environmental and/or safety programs, please contact the TI application engineer or visit www.ti.com/esh.

No license is granted under any patent right or other intellectual property right of TI covering or relating to any machine, process, or combination in which such TI products or services might be or are used.

FCC Warning

This evaluation board/kit is intended for use for **ENGINEERING DEVELOPMENT, DEMONSTRATION, OR EVALUATION PURPOSES ONLY** and is not considered by TI to be a finished end-product fit for general consumer use. It generates, uses, and can radiate radio frequency energy and has not been tested for compliance with the limits of computing devices pursuant to part 15 of FCC rules, which are designed to provide reasonable protection against radio frequency interference. Operation of this equipment in other environments may cause interference with radio communications, in which case the user at his own expense will be required to take whatever measures may be required to correct this interference.

Mailing Address: Texas Instruments, Post Office Box 655303, Dallas, Texas 75265
Copyright © 2007, Texas Instruments Incorporated

EVM WARNINGS AND RESTRICTIONS

It is important to operate this EVM within the input voltage range of 3.3 V to 5 V and the output voltage range of 0 V to 5 V.

Exceeding the specified input range may cause unexpected operation and/or irreversible damage to the EVM. If there are questions concerning the input range, please contact a TI field representative prior to connecting the input power.

Applying loads outside of the specified output range may result in unintended operation and/or possible permanent damage to the EVM. Please consult the EVM User's Guide prior to connecting any load to the EVM output. If there is uncertainty as to the load specification, please contact a TI field representative.

During normal operation, some circuit components may have case temperatures greater than 30°C. The EVM is designed to operate properly with certain components above 85°C as long as the input and output ranges are maintained. These components include but are not limited to linear regulators, switching transistors, pass transistors, and current sense resistors. These types of devices can be identified using the EVM schematic located in the EVM User's Guide. When placing measurement probes near these devices during operation, please be aware that these devices may be very warm to the touch.

Mailing Address: Texas Instruments, Post Office Box 655303, Dallas, Texas 75265
Copyright © 2007, Texas Instruments Incorporated

IMPORTANT NOTICE

Texas Instruments Incorporated and its subsidiaries (TI) reserve the right to make corrections, modifications, enhancements, improvements, and other changes to its products and services at any time and to discontinue any product or service without notice. Customers should obtain the latest relevant information before placing orders and should verify that such information is current and complete. All products are sold subject to TI's terms and conditions of sale supplied at the time of order acknowledgment.

TI warrants performance of its hardware products to the specifications applicable at the time of sale in accordance with TI's standard warranty. Testing and other quality control techniques are used to the extent TI deems necessary to support this warranty. Except where mandated by government requirements, testing of all parameters of each product is not necessarily performed.

TI assumes no liability for applications assistance or customer product design. Customers are responsible for their products and applications using TI components. To minimize the risks associated with customer products and applications, customers should provide adequate design and operating safeguards.

TI does not warrant or represent that any license, either express or implied, is granted under any TI patent right, copyright, mask work right, or other TI intellectual property right relating to any combination, machine, or process in which TI products or services are used. Information published by TI regarding third-party products or services does not constitute a license from TI to use such products or services or a warranty or endorsement thereof. Use of such information may require a license from a third party under the patents or other intellectual property of the third party, or a license from TI under the patents or other intellectual property of TI.

Reproduction of TI information in TI data books or data sheets is permissible only if reproduction is without alteration and is accompanied by all associated warranties, conditions, limitations, and notices. Reproduction of this information with alteration is an unfair and deceptive business practice. TI is not responsible or liable for such altered documentation. Information of third parties may be subject to additional restrictions.

Resale of TI products or services with statements different from or beyond the parameters stated by TI for that product or service voids all express and any implied warranties for the associated TI product or service and is an unfair and deceptive business practice. TI is not responsible or liable for any such statements.

TI products are not authorized for use in safety-critical applications (such as life support) where a failure of the TI product would reasonably be expected to cause severe personal injury or death, unless officers of the parties have executed an agreement specifically governing such use. Buyers represent that they have all necessary expertise in the safety and regulatory ramifications of their applications, and acknowledge and agree that they are solely responsible for all legal, regulatory and safety-related requirements concerning their products and any use of TI products in such safety-critical applications, notwithstanding any applications-related information or support that may be provided by TI. Further, Buyers must fully indemnify TI and its representatives against any damages arising out of the use of TI products in such safety-critical applications.

TI products are neither designed nor intended for use in military/aerospace applications or environments unless the TI products are specifically designated by TI as military-grade or "enhanced plastic." Only products designated by TI as military-grade meet military specifications. Buyers acknowledge and agree that any such use of TI products which TI has not designated as military-grade is solely at the Buyer's risk, and that they are solely responsible for compliance with all legal and regulatory requirements in connection with such use.

TI products are neither designed nor intended for use in automotive applications or environments unless the specific TI products are designated by TI as compliant with ISO/TS 16949 requirements. Buyers acknowledge and agree that, if they use any non-designated products in automotive applications, TI will not be responsible for any failure to meet such requirements.

Following are URLs where you can obtain information on other Texas Instruments products and application solutions:

Products		Applications	
Amplifiers	amplifier.ti.com	Audio	www.ti.com/audio
Data Converters	dataconverter.ti.com	Automotive	www.ti.com/automotive
DSP	dsp.ti.com	Broadband	www.ti.com/broadband
Interface	interface.ti.com	Digital Control	www.ti.com/digitalcontrol
Logic	logic.ti.com	Military	www.ti.com/military
Power Mgmt	power.ti.com	Optical Networking	www.ti.com/opticalnetwork
Microcontrollers	microcontroller.ti.com	Security	www.ti.com/security
RFID	www.ti-rfid.com	Telephony	www.ti.com/telephony
Low Power Wireless	www.ti.com/lpw	Video & Imaging	www.ti.com/video
		Wireless	www.ti.com/wireless

Mailing Address: Texas Instruments, Post Office Box 655303, Dallas, Texas 75265
Copyright © 2007, Texas Instruments Incorporated