

# User's Guide

## ADC12DLXX00 Evaluation Module



### ABSTRACT

The ADC12DLXX00 evaluation module (EVM) is used to evaluate the ADC12DL3200 and ADC12DL2500 analog-to-digital converters (ADC) from Texas Instruments. Throughout this document, the terms evaluation board, evaluation module, and EVM are synonymous with the ADC12DL3200EVM and ADC12DL2500EVM.

### Table of Contents

<b>1 Introduction</b>	2
Related Documentation	3
<b>2 Equipment</b>	4
2.1 Evaluation Board Feature Identification Summary	4
2.2 Required Equipment	5
<b>3 Setup Procedure</b>	6
3.1 Install the High Speed Data Converter (HSDC) Pro Software	7
3.2 Install the Configuration GUI Software	7
3.3 Connect the EVM and TSW14DL3200EVM	7
3.4 Connect the Power Supplies to the Boards (Power Off)	7
3.5 Connect the Signal Generators to the EVM (*RF Outputs Disabled Until Directed)	8
3.6 Turn On the TSW14DL3200EVM Power and Connect to the PC	8
3.7 Turn On the ADC12DLXX00EVM 5-V Power Supply and Connect to the PC	8
3.8 Turn On the Signal Generator RF Outputs	8
3.9 Open the ADC12DLXX00EVM GUI and Program the ADC and Clocks	9
3.10 Calibrate the ADC Device on the EVM	10
3.11 Open the HSDC Software and Load the FPGA Image to the TSW14DL3200EVM	11
3.12 Capture Data Using the HSDC Pro Software	12
<b>4 Device Configuration</b>	13
4.1 Tab Organization	13
4.2 Low-Level Control	13
<b>A Troubleshooting the ADC12DL3200EVM</b>	15
<b>B Optional ADC12DL3200EVM Configurations</b>	16
<b>C Revision History</b>	16

### List of Figures

Figure 2-1. EVM Feature Locations	4
Figure 3-1. EVM Test Setup	6
Figure 3-2. Configuration GUI: EVM Tab	9
Figure 3-3. Configuration GUI: Control Tab	10
Figure 3-4. HSDC Pro GUI	12
Figure 4-1. Configuration GUI: Low-Level View Tab	13
Figure B-1. External CLK Configuration	16

### List of Tables

Table 4-1. Low-Level Controls	14
Table A-1. Troubleshooting	15

## Trademarks

Keysight™ is a trademark of Keysight Technologies.

Trilithic™ is a trademark of Trilithic, Inc..

K&L Microwave™ is a trademark of K&L Microwave.

SEARAY® is a registered trademark of Samtec.

Microsoft® and Windows® are registered trademarks of Microsoft Corporation.

Rohde & Schwarz® is a registered trademark of Rohde & Schwarz GmbH & Co..

All trademarks are the property of their respective owners.

## 1 Introduction

The ADC12DLXX00 is a dual-channel, 12-bit ADC, capable of operating at sampling rates up to 3.2 Giga-samples per second (GSPS) and 2.5 GSPS in dual-channel mode, or 6.4 GSPS and 5 GSPS in single-channel mode. The ADC12DLXX00EVM device output data is transmitted over a high-speed LVDS interface. This evaluation board also includes the following important features:

- Transformer-coupled signal input network allowing a single-ended signal source from 500 kHz to 9 GHz
- The LMX2582 clock synthesizer generates the ADC sampling clock
- Transformer-coupled clock input network to test the ADC performance with an external low-noise clock source
- LM95233 temperature sensor
- Device register programming through USB connector and FTDI USB-to-SPI bus translator
- High-speed LVDS data output over a 400-pin SEARAY® interface connector

### Note

While this is the same connector used for FMC standard boards, the LVDS data, clock and strobe pinout is proprietary to the ADC12DL3200EVM, TSW14DL3200EVM, and other compatible boards.

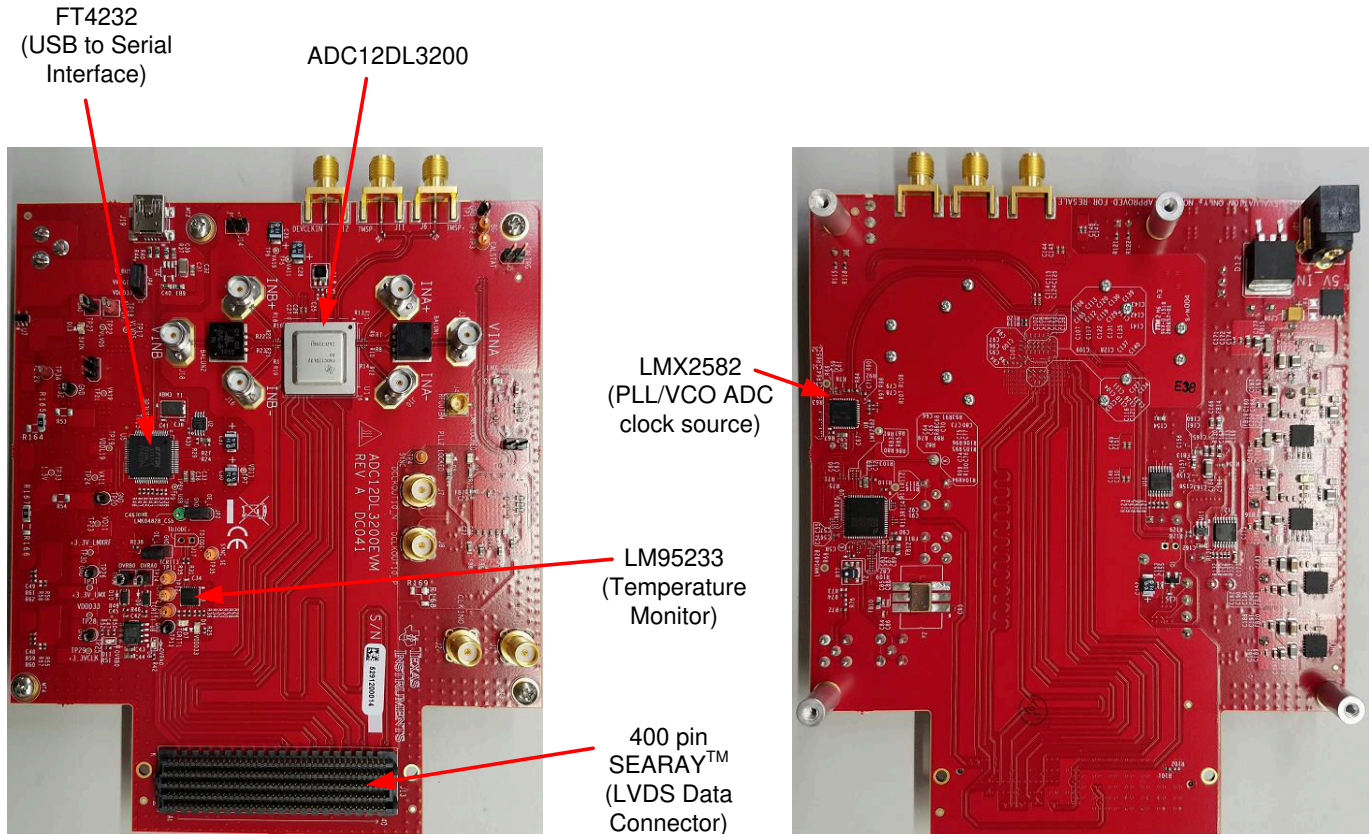

The digital data from the ADC12DLXX00EVM board is quickly and easily captured with the TSW14DL3200EVM data capture board.

---

**Note**

The TSW14DL3200EVM supports 48 data pairs (Demux = 1) up to 1600 Mbps.

---

The TSW14DL3200EVM captures the LVDS data, decodes the data, stores the data in memory, and then uploads the data to a connected PC through a USB interface for analysis. The High-Speed Data Converter Pro (HSDC Pro) software on the PC communicates with the hardware and processes the data.

In the following sections of this document, the ADC12DLXX00EVM is referred to as the *EVM* and the ADC12DLXX00 device is referred to as the *ADC* device.

**Related Documentation****Technical Reference Documents**

- [ADC12DL3200 Data Sheet](#)
- [ADC12DL2500 Data Sheet](#)
- [TSW14DL3200EVM User's Guide](#)
- [HSDC Pro software User's Guide](#) (also available in the help menu of the software)
- [LMX2582 Data Sheet](#)
- [LMK04828 Data Sheet](#)
- [FTDI USB to Serial Driver Installation Manual](#)

**TSW14DL3200EVM Operation**

Refer to the [TSW14DL3200EVM User's Guide](#) for configuration and status information.

## 2 Equipment

This section describes the equipment needed to evaluate the full performance of the ADC device.

### 2.1 Evaluation Board Feature Identification Summary

Figure 2-1 shows the EVM features.

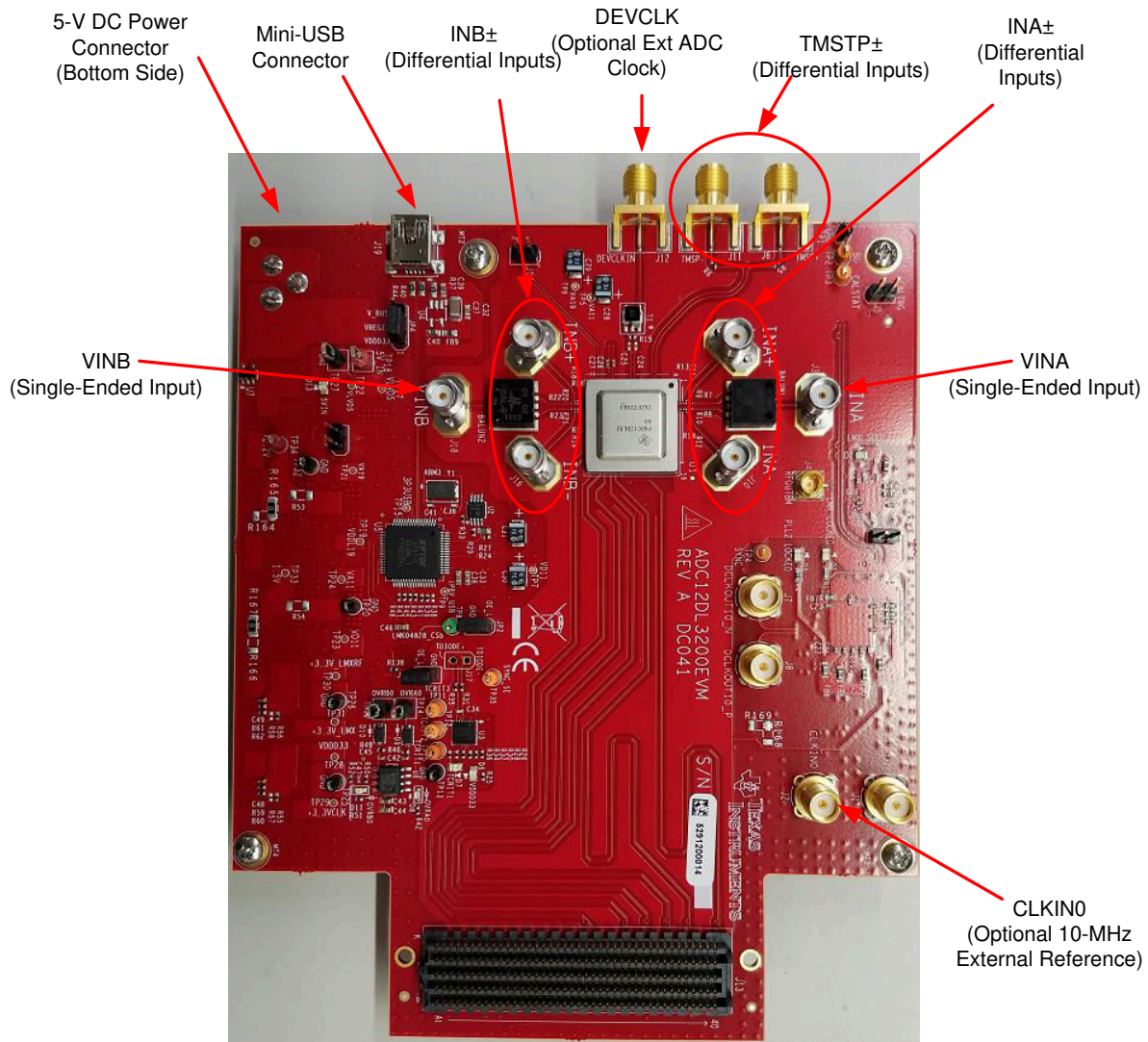

**Figure 2-1. EVM Feature Locations**

## 2.2 Required Equipment

The following equipment and documents are included in the EVM evaluation kit:

- Evaluation board (EVM)
- Mini-USB cable
- Power cable

The following equipment is *not* included in the EVM evaluation kit, but is required for evaluation of this product:

- TSW14DL3200EVM data capture board and related items
- HSDC Pro software
- Computer (PC) running the Microsoft® Windows® operating system (XP, 7, 8, or 10)
- One low-noise signal generator for analog input. TI recommends the following generators:
  - Keysight™ E8663D
  - Rohde & Schwarz® SMA100A or SMA100B
- Bandpass filter for analog input signal (2482 MHz or desired frequency). The following filters are recommended:
  - Bandpass filter (BPF):
    - Greater than or equal to 60-dB harmonic attenuation
    - Less than or equal to 5% bandwidth
    - Greater than 18-dBm power
    - Less than 5-dB insertion loss
  - Trilithic™ 5VH-series tunable BPF
  - K&L Microwave™ BT-series tunable BPF
  - TTE KC6 or KC7-series fixed BPF
- Signal-path cables, SMA or BNC (or both SMA and BNC)

By default, the ADC12DLXX00EVM has an onboard clocking solution. A few small board modifications enable external clocking. If external clocking is used, the following additional equipment is recommended.

- One low-noise signal generator. TI recommends models similar to the analog input source.
- A bandpass filter for the DEVCLK input. TI recommends a filter similar to the analog-input path filter.

### 3 Setup Procedure

This section describes how to setup the EVM on the bench with the proper equipment to evaluate the full performance of the ADC device. [Figure 3-1](#) shows the EVM test setup.

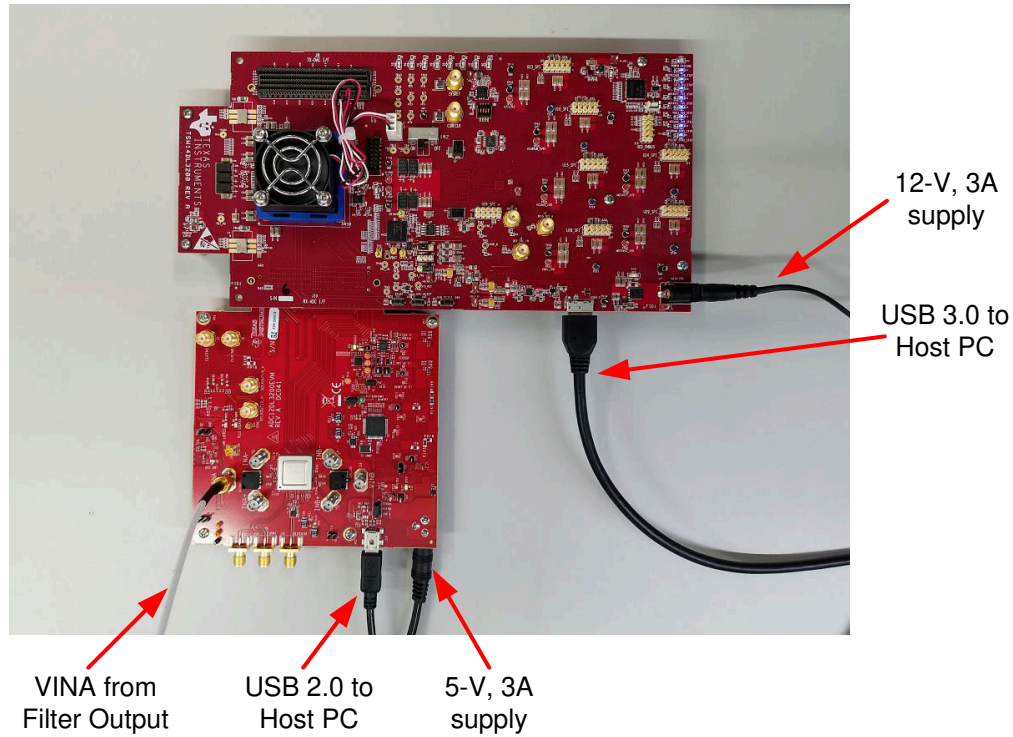

**Figure 3-1. EVM Test Setup**

---

#### Note

The HSDC Pro software must be installed before connecting the TSW14DL3200EVM to the PC for the first time.

---

### 3.1 Install the High Speed Data Converter (HSDC) Pro Software

Download the most recent version of the HSDC Pro software from [www.ti.com/tool/dataconverterpro-sw](http://www.ti.com/tool/dataconverterpro-sw). Follow the installation instructions to install the software.

### 3.2 Install the Configuration GUI Software

1. Download the configuration graphical user interface (GUI) software from the EVM tool folder at <http://www.ti.com/tool/ADC12DL3200EVM>.
2. Extract files from the compressed zip file.
3. Run the executable file ( `setup.exe` ), and follow the instructions.

### 3.3 Connect the EVM and TSW14DL3200EVM

With the power off, connect the ADC12DLXX00EVM to the TSW14DL3200EVM through the FMC connector as shown in [Figure 3-1](#). Make sure that the standoffs provide the proper height for robust connector connections.

### 3.4 Connect the Power Supplies to the Boards (Power Off)

1. Confirm that the power switch on the TSW14DL3200EVM is in the off position. Connect the power cable to a 12-V DC (minimum 3-A) power supply. Make sure that the proper supply polarity by confirming that the outer surface of the barrel connector is GND and the inner portion of the connector is 12-V. Connect the power cable to the EVM power connector.
2. Connect the power cable to a 5-V DC (minimum 3-A) power supply for the ADC12DLXX00EVM. Make sure the proper supply polarity by confirming that the outer surface of the barrel connector is GND and the inner portion of the connector is 5-V. Connect the power cable to the EVM power connector.

#### CAUTION

Make sure that the power connections to the EVMs are the correct polarity. Failure to do so may result in immediate damage.

Make sure that the 12-V power supply is connected to the TSW14DL3200EVM and not the ADC12DLXX00EVM. Providing the ADC12DLXX00EVM with 12-V may result in immediate damage.

Leave the TSW14DL3200EVM power switch in the off position until directed later.

### 3.5 Connect the Signal Generators to the EVM (\*RF Outputs Disabled Until Directed)

Connect a signal generator to the VIN input of the ADC12DLXX00EVM through a bandpass filter and attenuator at the SMA connector. This must be a low-noise signal generator. TI recommends a Trilithic-tunable bandpass filter to filter the signal from the generator. Configure the signal generator for 1910 MHz, 0 dBm.

#### 3.5.1 If External Clocking is Used (Optional)

Connect a signal generator to the DEVCLK input of the EVM through a bandpass filter. This signal generator must be a low-noise signal generator. TI recommends a Trilithic-tunable bandpass filter to filter the signal coming from the generator. Configure the signal generator for the desired clock frequency in the range of 0.8 to 3.2 GHz. For best performance when using an RF signal generator, the power input to the CLK SMA connector must be 9 dBm (2.2 Vpp into 50 Ω). The signal generator must increase above 9 dB by an amount equal to any additional attenuation in the clock signal path, such as the insertion loss of the bandpass filter. For example, if the filter insertion loss is 2 dB, the signal generator must be set to 9 dBm + 2 dB = 11 dBm.

### 3.6 Turn On the TSW14DL3200EVM Power and Connect to the PC

1. Turn on the 12-V power supply connected to the TSW14DL3200EVM.
2. Turn on the power switch on the TSW14DL3200EVM.
3. Connect a mini USB 3.0 cable from the PC to the TSW14DL3200EVM.
4. If this is the first time connecting the TSW14DL3200EVM to the PC, follow the on-screen instructions to automatically install the device drivers. See the [TSW14DL3200EVM user's guide](#) for specific instructions.

### 3.7 Turn On the ADC12DLXX00EVM 5-V Power Supply and Connect to the PC

1. Turn on the 5-V power supply to power up the EVM.
2. Connect the EVM to the PC with the mini USB cable.

### 3.8 Turn On the Signal Generator RF Outputs

Turn on the RF signal output of the signal generator connected to VIN. If external clocking is used, turn on the RF signal outputs connected to DEVCLK and LMKCLK.



### 3.9 Open the ADC12DLXX00EVM GUI and Program the ADC and Clocks

The device configuration GUI is installed separately from the HSDC Pro installation and is a stand-alone GUI.

Figure 3-2 shows the GUI open to the *EVM* tab. Tabs at the top of the panel organize the configuration into device and EVM features, with user-friendly controls and a low-level tab for directly configuring the registers. The EVM has three configurable devices: the [ADC12DLXX00](#), [LMK04828](#), and [LMX2582](#). The register map for each device is provided in the device data sheets.

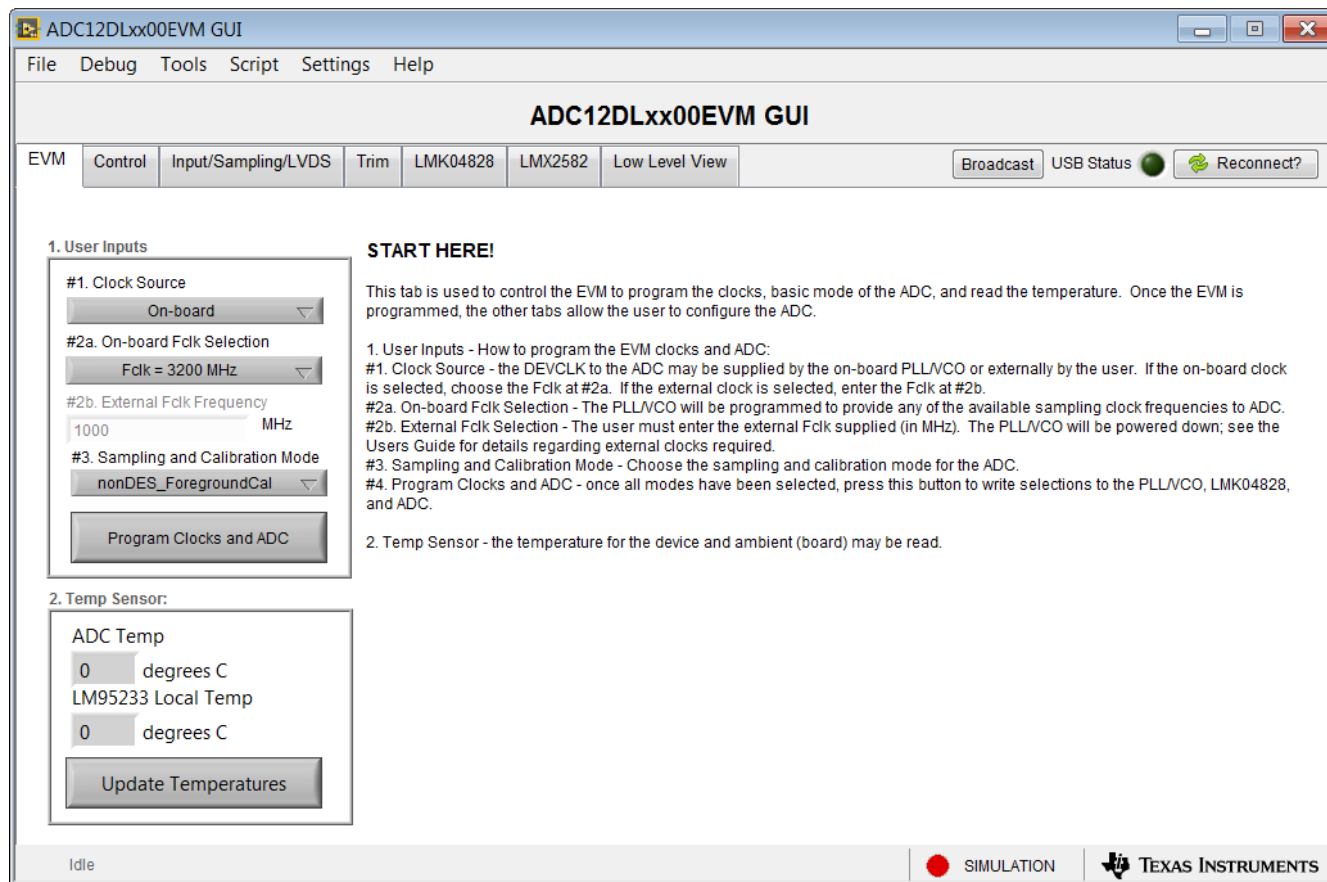
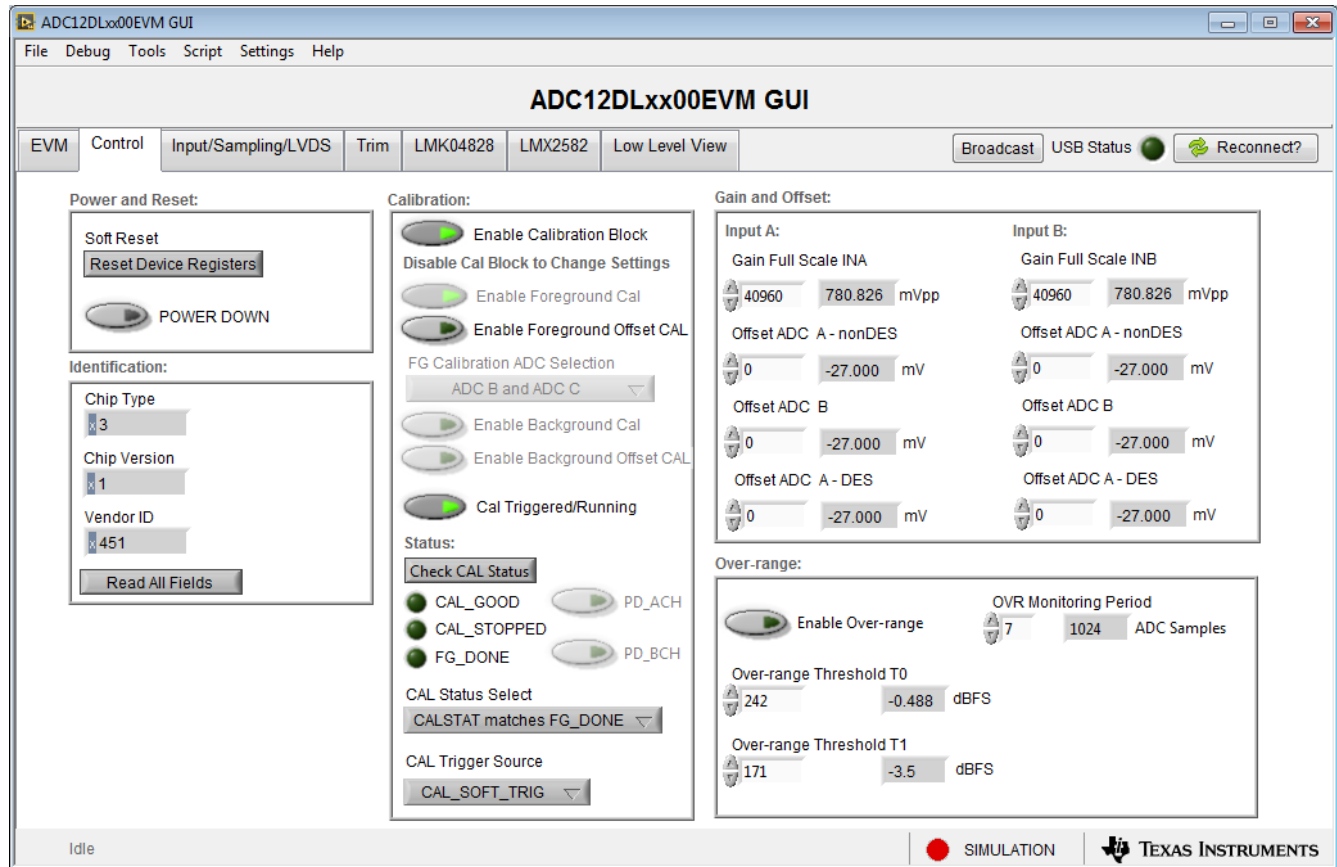

**Figure 3-2. Configuration GUI: EVM Tab**

1. Open the ADC12DLxx00EVM GUI.
2. Select the onboard clock as the clock source.
3. If using ADC12DL3200 evm variant select Fs/Fclk = 3200 MHz as the onboard Fs/Fclk. If using ADC12DL2500 evm variant set Fs/Fclk to 2500 MHz selection.
4. Select *nonDES\_ForegroundCal* operating mode.
5. Click *Program Clocks and ADC*. This action overwrites any previous device register settings.

### 3.10 Calibrate the ADC Device on the EVM

Figure 3-3 shows the GUI open to the *Control* tab.



**Figure 3-3. Configuration GUI: Control Tab**

1. With the EVM GUI open on the PC, navigate to the *Control* tab.
2. To calibrate the ADC, click the *Cal Triggered/Running* button once, and then click the button again. This action stops and starts the calibration engine.

#### Note

The *Cal Triggered/Running* button executes a calibration sequence that is required for full performance. This calibration is performed automatically during the previous step shown in [Section 3.9](#), but must be performed again any time the sampling rate changes, after significant temperature change of the ADC, or after exiting the power-down mode. See the [ADC12DL3200 device data sheet](#) for details regarding the necessary calibration sequence.

3. On the *EVM* tab, using the *Sampling and Calibration Mode* drop-down menu, select *Foreground*, *Background*, or *Low Power Background* calibration mode.

### 3.11 Open the HSDC Software and Load the FPGA Image to the TSW14DL3200EVM

1. Open the HSDC Pro software.
2. Click *OK* to confirm the serial number of the TSW14DL3200EVM device. If multiple TSWxxxxx boards are connected, select the model and serial number for the one connected to the ADC12DLXX00EVM.
3. Select the ADC12DL3200\_LDEMUX\_1\_DES\_EN\_0 when prompted to load the firmware.
4. When prompted, click *Yes* to update the firmware.

---

#### Note

If the user configures the EVM with options other than the default register values, different instructions may be required for selecting the device in HSDC Pro. See [Appendix B](#) for more details.

5. Enter the ADC Output Data Rate ( $f_{\text{SAMPLE}}$ ) as  $3200M$  if using the ADC12DL3200 variant of the evm or  $2500M$  if the ADC12DL2500 variant of the evm is used, or the desired output sample rate. This number must be equal to the actual sampling rate of the device, and must be updated if the sampling rate changes.

### 3.12 Capture Data Using the HSDC Pro Software

Figure 3-4 shows the HSDC Pro GUI. The following steps show how to capture data using the HSDC Pro software (see):

1. Select the test to perform.
2. Select the data view.
3. Select the channel to view.
4. Click the *Capture* button to capture new data.

Additional tips:

- Use the *Notch Frequency Bins* from the *Test Options* file menu to remove bins around DC (eliminate DC noise and offset) or the fundamental (eliminate phase noise from signal generators).
- Open the *Capture Option* dialog from the *Data Capture Options* file menu to change the capture depth or to enable Continuous Capture or FFT averaging.
- For analyzing only a portion of the spectrum, use the *Single Tone* test with the *Bandwidth Integration Markers* from the *Test Options* file menu. The *Channel Power* test is also useful.
- For analyzing only a subset of the captured data, set the *Analysis Window (samples)* setting to a value less than the number of total samples captured and move the green or red markers in the small transient data window at the top of the screen to select the data subset of interest.

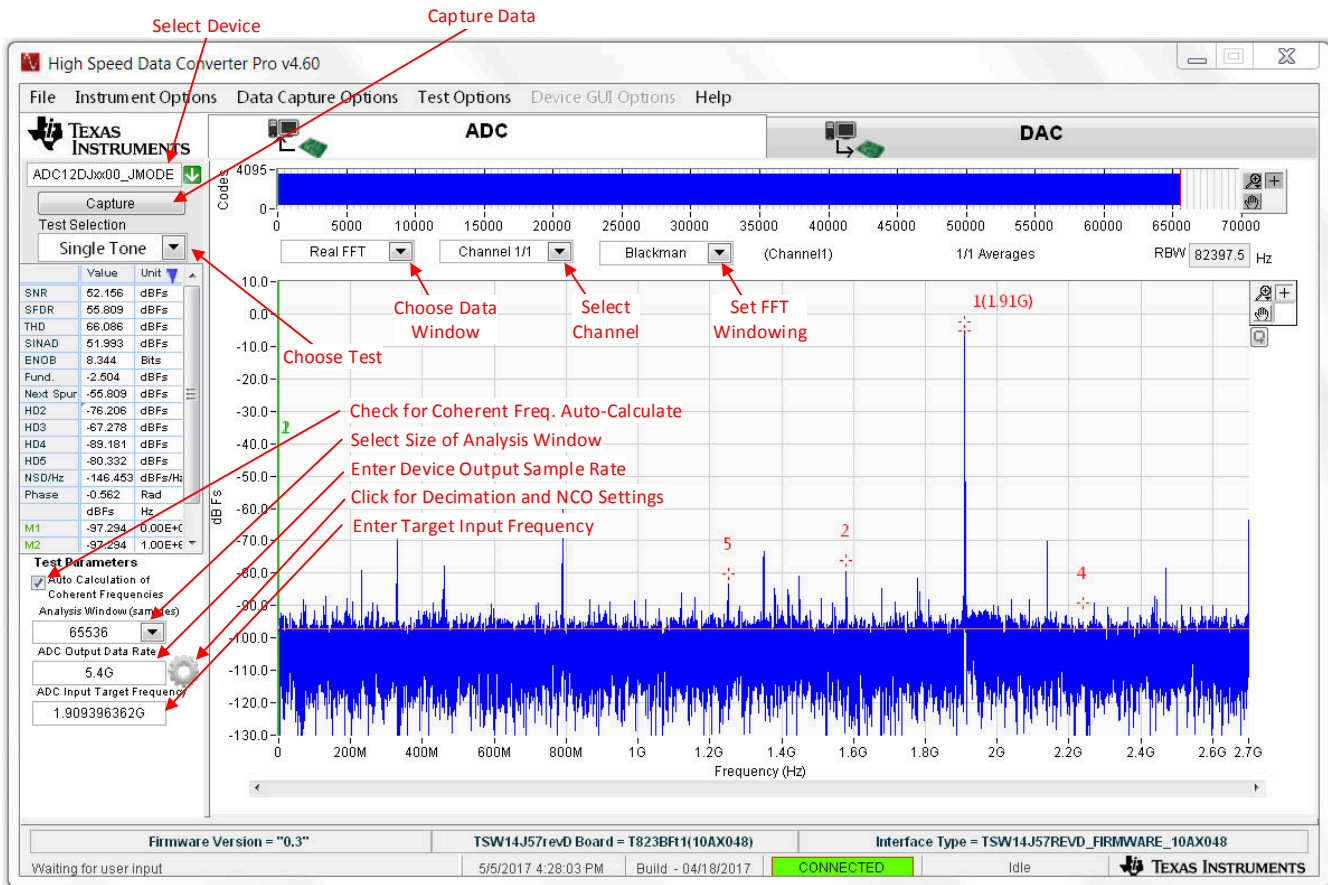

Figure 3-4. HSDC Pro GUI

## 4 Device Configuration

The ADC device is programmable through the serial programming interface (SPI) bus accessible through the FTDI USB-to-SPI converter located on the EVM. A GUI is provided to write instructions on the bus and program the registers of the ADC device.

For more information about the registers in the ADC device, see the [ADC12DL3200 data sheet](#).

### 4.1 Tab Organization

Control of the ADC device features are available in the *EVM*, *Control*, *Input/Sampling/LVDS*, and *Trim* configuration tabs.

### 4.2 Low-Level Control

The *Low Level View* tab, illustrated in [Figure 4-1](#), allows configuration of the devices at the bit-field level. At any time, the controls in [Table 4-1](#) can be used to configure or read from the device.

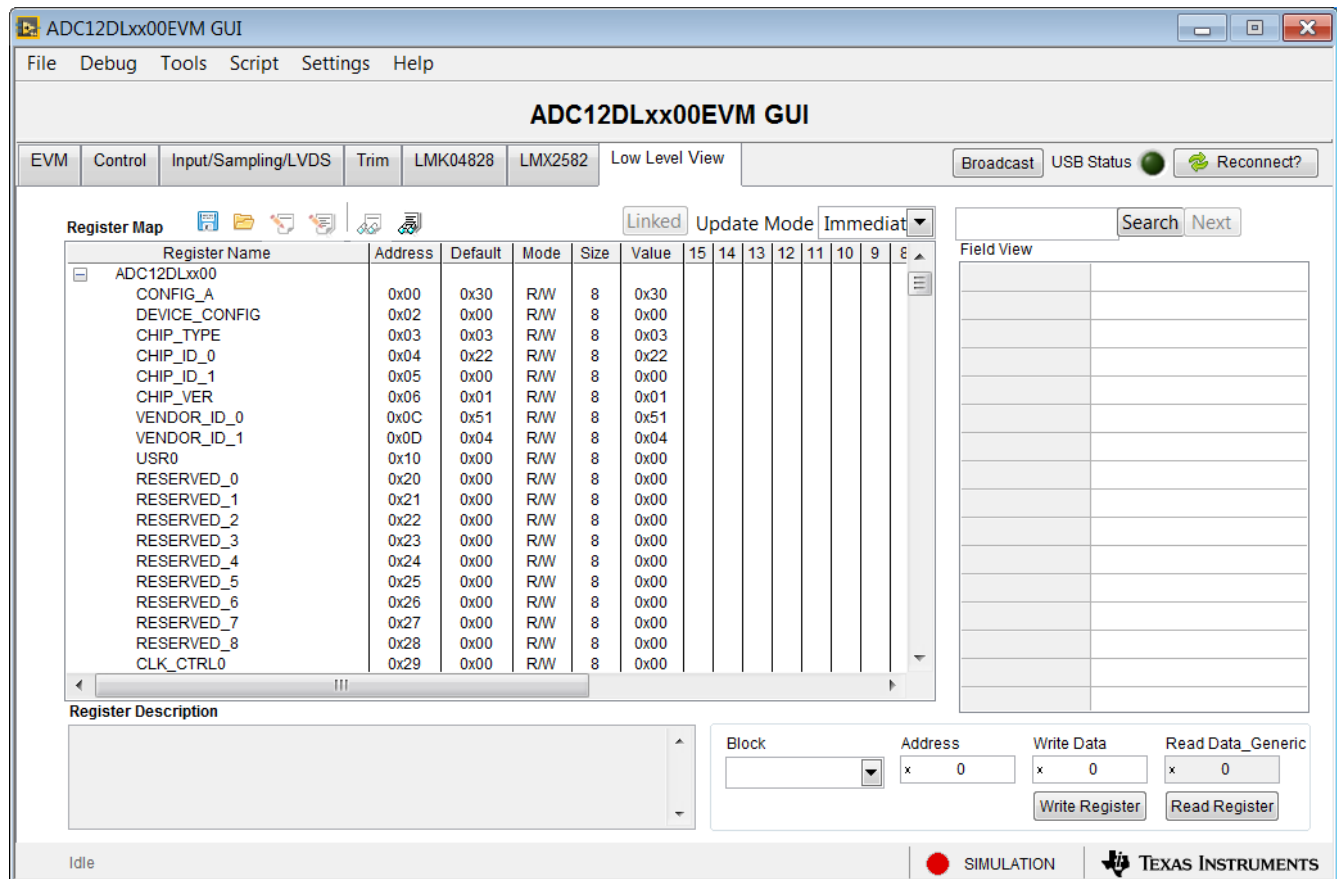

Figure 4-1. Configuration GUI: Low-Level View Tab

**Table 4-1. Low-Level Controls**

<b>Control</b>	<b>Description</b>
Register map summary	Displays the devices on the EVM, registers for those devices, and the states of the registers <ul style="list-style-type: none"> <li>Clicking on a register field allows individual bit manipulation in the register data cluster</li> <li>The value column shows the value of the register at the time the GUI was last updated</li> <li>The LR column shows the value of the register at the time the register was last read</li> </ul>
Write register button	Write to the register highlighted in the register map summary with the value in the <i>Write Data</i> field
Write all button	Update all registers shown in the register map summary with the values shown in the <i>Register Map</i> summary
Read register button	Read from the register highlighted in the <i>Register Map</i> summary and display the results in the <i>Read Data</i> field Can be used to synchronize the GUI with the state of the hardware
Read-all button	Read from all registers in the <i>Register Map</i> summary and display the current state of the hardware
<i>Load Configuration</i> button	Load a configuration file from disk and register address/data values in the file
<i>Save Configuration</i> button	Save a configuration file to disk that contains the current state of the configuration registers
<i>Register Data</i> cluster	Manipulate individual accessible bits of the register highlighted in the register map summary
Individual register cluster with read or write register buttons	Perform a generic read or write command to the device shown in the <i>Block</i> drop-down menu using the address and write data information

## A Troubleshooting the ADC12DL3200EVM

Table A-1 lists some troubleshooting procedures.

**Table A-1. Troubleshooting**

Issue	Troubleshoot
General problems	<ul style="list-style-type: none"> <li>• Verify the test setup shown in <a href="#">Figure 3-1</a>, and repeat the setup procedure as described in this document.</li> <li>• Check power supply to EVM and TSW14DL3200EVM. Verify that the power switch is in the on position.</li> <li>• Check signal and clock connections to EVM.</li> <li>• Visually check the top and bottom sides of the board to verify that nothing looks discolored or damaged.</li> <li>• Make sure the board-to-board FMC connection is secure.</li> <li>• After changing the ADC configuration, click <i>Instrument Options</i> → <i>Download Firmware</i> and download <i>TSW14DL3200_FIRMWARE.bin</i>.</li> <li>• Power cycle the external power supply to the EVM, and reprogram the LMK and ADC devices.</li> </ul>
TSW14DL3200EVM LEDs are not correct	<ul style="list-style-type: none"> <li>• Verify the installed jumpers on the TSW14DL3200EVM.</li> <li>• Verify that the clock going to the CLK input is connected and the appropriate LEDs are blinking.</li> <li>• Verify that the ADC device internal registers are configured properly.</li> <li>• If LEDs are not blinking, reprogram the ADC EVM devices.</li> <li>• Click <i>Instrument Options</i> → <i>Download Firmware</i> and download <i>TSW14DL3200_FIRMWARE.bin</i>.</li> </ul>
Configuration GUI is not working properly	<ul style="list-style-type: none"> <li>• Verify that the USB cable is plugged into the EVM and the PC.</li> <li>• Check the computer device manager and verify that a <i>USB serial device</i> is recognized when the EVM is connected to the PC.</li> <li>• Verify that the green <i>USB Status</i> LED light in the top right corner of the GUI is lit. If it is not lit, click the <i>Reconnect FTDI</i> button.</li> <li>• Close and start the configuration GUI.</li> </ul>
Configuration GUI is not able to connect to the EVM	<ul style="list-style-type: none"> <li>• Use the free FT_PROG software from FTDI chip and verify that the onboard FTDI chip is programmed with the product description <i>ADC12DL3200</i>.</li> </ul>
HSDC Pro software is not capturing good data or analysis results are incorrect.	<ul style="list-style-type: none"> <li>• Verify that the TSW14DL3200EVM is properly connected to the PC with a mini USB 3.0 cable and that the board serial number is properly identified by the HSDC software.</li> <li>• Check that the proper ADC device mode is selected. The mode should match in HSDC Pro and the ADC GUI.</li> <li>• Check that the analysis parameters are properly configured.</li> </ul>
HSDC Pro software gives a time-out error when capturing data	<ul style="list-style-type: none"> <li>• Verify that the ADC sampling rate is correctly set in the HSDC software.</li> <li>• Select <i>Instrument Options</i> → <i>Download Firmware</i> and download <i>TSW14DL3200_FIRMWARE.bin</i>. Try to capture again.</li> </ul>
Suboptimal measured performance	<ul style="list-style-type: none"> <li>• Click <i>Cal Triggered/Running</i> button two times to calibrate the ADC in the current operating conditions. The button is located on the <i>Control</i> tab of the configuration GUI.</li> <li>• Check that the spectral analysis parameters are properly configured.</li> <li>• Verify that bandpass filters are used in the clock and input signal paths and that low-noise signal sources are used.</li> </ul>

## B Optional ADC12DL3200EVM Configurations

This appendix provides settings for modifying the EVM for optional clocking support.

The LMK04828 provides a buffered copy of the onboard 100-MHz VCXO to the LMX2582. When the optional 10-MHz reference clock is connected, the 100-MHz VCXO output is frequency locked to the 10-MHz reference. This process enables coherent sampling of the analog input signal. The EVM can be configured to use an external ADC clock with the following steps (see [Figure B-1](#)):

1. Modify the hardware:
  - a. Remove C114 and C124, populate C24 and C25.
2. Connect the signal generators:
  - a. Connect the 10-MHz reference from Sig Gen 1 to Sig Gen 2.
  - b. Configure Sig Gen 2 to use the 10-MHz reference input from Sig Gen 1.
  - c. Sig Gen 1 connects to DEVCLK (J12). Set to the generator frequency to the desired  $F_{CLK}$ . Set output level to +9 dBm.
  - d. Sig Gen 2 connects to the desired analog input with output level at 0 dBm for the starting point.
3. Program the GUI:
  - a. In the *EVM* tab, set the clock source to *External*.
  - b. Enter the *Sampling Frequency* ( $F_{CLK}$ ) in step 2b.

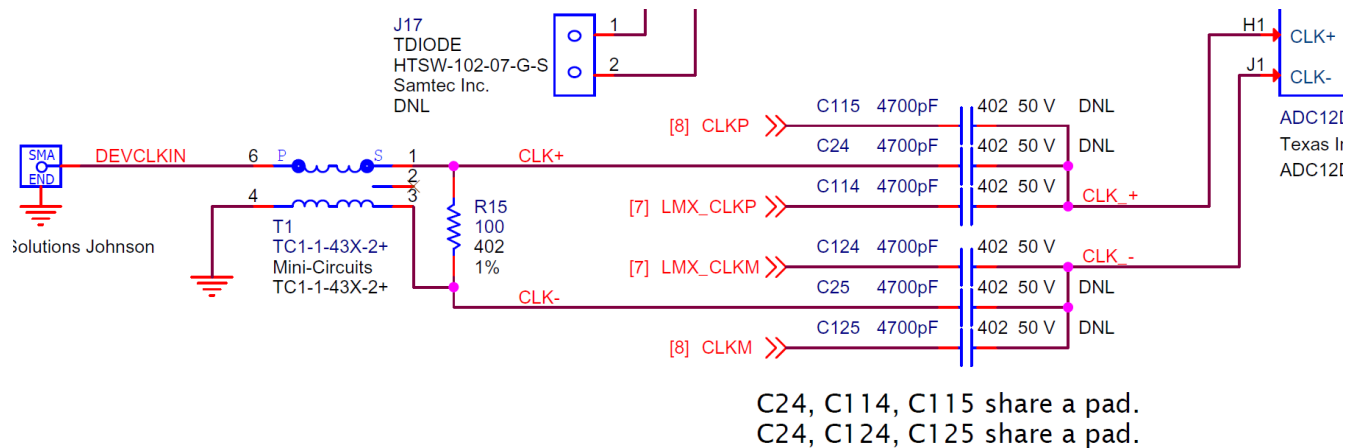

**Figure B-1. External CLK Configuration**

The ADC12DL3200EVM includes a reference clock input (CLKIN0) that allows the user to sync the LMK04828 to an external 10-MHz reference allowing for coherent sampling

The LMX2582 and LMK04828 may be reconfigured to exercise more features, but this EVM is not intended to be a full evaluation platform for these devices. For a full evaluation platform, see the [LMK04828 tool folder](#) and [LMX2582 tool folder](#).

## C Revision History

NOTE: Page numbers for previous revisions may differ from page numbers in the current version.

Changes from Revision * (May 2018) to Revision A (December 2023)	Page
• Changed the device number from ADC12DL3200 to ADC12DLXX00 throughout the document.....	1
• Added device <i>Abstract</i> .....	1
• Updated the <i>Introduction</i> .....	2
• Added the ADC12DL2500 Data Sheet to the <i>Technical Reference Documents</i> .....	3
• Changed list item 3 following <a href="#">Figure 3-2</a> .....	9
• Changed the <a href="#">Open the HSDC Software and Load the FPGA Image to the TSW14DL3200EVM</a> section.....	11



## STANDARD TERMS FOR EVALUATION MODULES

1. *Delivery:* TI delivers TI evaluation boards, kits, or modules, including any accompanying demonstration software, components, and/or documentation which may be provided together or separately (collectively, an "EVM" or "EVMs") to the User ("User") in accordance with the terms set forth herein. User's acceptance of the EVM is expressly subject to the following terms.
  - 1.1 EVMs are intended solely for product or software developers for use in a research and development setting to facilitate feasibility evaluation, experimentation, or scientific analysis of TI semiconductors products. EVMs have no direct function and are not finished products. EVMs shall not be directly or indirectly assembled as a part or subassembly in any finished product. For clarification, any software or software tools provided with the EVM ("Software") shall not be subject to the terms and conditions set forth herein but rather shall be subject to the applicable terms that accompany such Software
  - 1.2 EVMs are not intended for consumer or household use. EVMs may not be sold, sublicensed, leased, rented, loaned, assigned, or otherwise distributed for commercial purposes by Users, in whole or in part, or used in any finished product or production system.
2. *Limited Warranty and Related Remedies/Disclaimers:*
  - 2.1 These terms do not apply to Software. The warranty, if any, for Software is covered in the applicable Software License Agreement.
  - 2.2 TI warrants that the TI EVM will conform to TI's published specifications for ninety (90) days after the date TI delivers such EVM to User. Notwithstanding the foregoing, TI shall not be liable for a nonconforming EVM if (a) the nonconformity was caused by neglect, misuse or mistreatment by an entity other than TI, including improper installation or testing, or for any EVMs that have been altered or modified in any way by an entity other than TI, (b) the nonconformity resulted from User's design, specifications or instructions for such EVMs or improper system design, or (c) User has not paid on time. Testing and other quality control techniques are used to the extent TI deems necessary. TI does not test all parameters of each EVM. User's claims against TI under this Section 2 are void if User fails to notify TI of any apparent defects in the EVMs within ten (10) business days after delivery, or of any hidden defects with ten (10) business days after the defect has been detected.
  - 2.3 TI's sole liability shall be at its option to repair or replace EVMs that fail to conform to the warranty set forth above, or credit User's account for such EVM. TI's liability under this warranty shall be limited to EVMs that are returned during the warranty period to the address designated by TI and that are determined by TI not to conform to such warranty. If TI elects to repair or replace such EVM, TI shall have a reasonable time to repair such EVM or provide replacements. Repaired EVMs shall be warranted for the remainder of the original warranty period. Replaced EVMs shall be warranted for a new full ninety (90) day warranty period.

### **WARNING**

**Evaluation Kits are intended solely for use by technically qualified, professional electronics experts who are familiar with the dangers and application risks associated with handling electrical mechanical components, systems, and subsystems.**

**User shall operate the Evaluation Kit within TI's recommended guidelines and any applicable legal or environmental requirements as well as reasonable and customary safeguards. Failure to set up and/or operate the Evaluation Kit within TI's recommended guidelines may result in personal injury or death or property damage. Proper set up entails following TI's instructions for electrical ratings of interface circuits such as input, output and electrical loads.**

**NOTE:**

**EXPOSURE TO ELECTROSTATIC DISCHARGE (ESD) MAY CAUSE DEGRADATION OR FAILURE OF THE EVALUATION KIT; TI RECOMMENDS STORAGE OF THE EVALUATION KIT IN A PROTECTIVE ESD BAG.**

### 3 Regulatory Notices:

#### 3.1 United States

##### 3.1.1 Notice applicable to EVMs not FCC-Approved:

**FCC NOTICE:** This kit is designed to allow product developers to evaluate electronic components, circuitry, or software associated with the kit to determine whether to incorporate such items in a finished product and software developers to write software applications for use with the end product. This kit is not a finished product and when assembled may not be resold or otherwise marketed unless all required FCC equipment authorizations are first obtained. Operation is subject to the condition that this product not cause harmful interference to licensed radio stations and that this product accept harmful interference. Unless the assembled kit is designed to operate under part 15, part 18 or part 95 of this chapter, the operator of the kit must operate under the authority of an FCC license holder or must secure an experimental authorization under part 5 of this chapter.

##### 3.1.2 For EVMs annotated as FCC – FEDERAL COMMUNICATIONS COMMISSION Part 15 Compliant:

#### **CAUTION**

This device complies with part 15 of the FCC Rules. Operation is subject to the following two conditions: (1) This device may not cause harmful interference, and (2) this device must accept any interference received, including interference that may cause undesired operation.

Changes or modifications not expressly approved by the party responsible for compliance could void the user's authority to operate the equipment.

#### **FCC Interference Statement for Class A EVM devices**

*NOTE: This equipment has been tested and found to comply with the limits for a Class A digital device, pursuant to part 15 of the FCC Rules. These limits are designed to provide reasonable protection against harmful interference when the equipment is operated in a commercial environment. This equipment generates, uses, and can radiate radio frequency energy and, if not installed and used in accordance with the instruction manual, may cause harmful interference to radio communications. Operation of this equipment in a residential area is likely to cause harmful interference in which case the user will be required to correct the interference at his own expense.*

#### **FCC Interference Statement for Class B EVM devices**

*NOTE: This equipment has been tested and found to comply with the limits for a Class B digital device, pursuant to part 15 of the FCC Rules. These limits are designed to provide reasonable protection against harmful interference in a residential installation. This equipment generates, uses and can radiate radio frequency energy and, if not installed and used in accordance with the instructions, may cause harmful interference to radio communications. However, there is no guarantee that interference will not occur in a particular installation. If this equipment does cause harmful interference to radio or television reception, which can be determined by turning the equipment off and on, the user is encouraged to try to correct the interference by one or more of the following measures:*

- Reorient or relocate the receiving antenna.
- Increase the separation between the equipment and receiver.
- Connect the equipment into an outlet on a circuit different from that to which the receiver is connected.
- Consult the dealer or an experienced radio/TV technician for help.

#### 3.2 Canada

##### 3.2.1 For EVMs issued with an Industry Canada Certificate of Conformance to RSS-210 or RSS-247

#### **Concerning EVMs Including Radio Transmitters:**

This device complies with Industry Canada license-exempt RSSs. Operation is subject to the following two conditions:

(1) this device may not cause interference, and (2) this device must accept any interference, including interference that may cause undesired operation of the device.

#### **Concernant les EVMs avec appareils radio:**

Le présent appareil est conforme aux CNR d'Industrie Canada applicables aux appareils radio exempts de licence. L'exploitation est autorisée aux deux conditions suivantes: (1) l'appareil ne doit pas produire de brouillage, et (2) l'utilisateur de l'appareil doit accepter tout brouillage radioélectrique subi, même si le brouillage est susceptible d'en compromettre le fonctionnement.

#### **Concerning EVMs Including Detachable Antennas:**

Under Industry Canada regulations, this radio transmitter may only operate using an antenna of a type and maximum (or lesser) gain approved for the transmitter by Industry Canada. To reduce potential radio interference to other users, the antenna type and its gain should be so chosen that the equivalent isotropically radiated power (e.i.r.p.) is not more than that necessary for successful communication. This radio transmitter has been approved by Industry Canada to operate with the antenna types listed in the user guide with the maximum permissible gain and required antenna impedance for each antenna type indicated. Antenna types not included in this list, having a gain greater than the maximum gain indicated for that type, are strictly prohibited for use with this device.

### Concernant les EVMs avec antennes détachables

Conformément à la réglementation d'Industrie Canada, le présent émetteur radio peut fonctionner avec une antenne d'un type et d'un gain maximal (ou inférieur) approuvé pour l'émetteur par Industrie Canada. Dans le but de réduire les risques de brouillage radioélectrique à l'intention des autres utilisateurs, il faut choisir le type d'antenne et son gain de sorte que la puissance isotrope rayonnée équivalente (p.i.r.e.) ne dépasse pas l'intensité nécessaire à l'établissement d'une communication satisfaisante. Le présent émetteur radio a été approuvé par Industrie Canada pour fonctionner avec les types d'antenne énumérés dans le manuel d'usage et ayant un gain admissible maximal et l'impédance requise pour chaque type d'antenne. Les types d'antenne non inclus dans cette liste, ou dont le gain est supérieur au gain maximal indiqué, sont strictement interdits pour l'exploitation de l'émetteur.

#### 3.3 Japan

3.3.1 *Notice for EVMs delivered in Japan:* Please see [http://www.tij.co.jp/lstds/ti\\_ja/general/eStore/notice\\_01.page](http://www.tij.co.jp/lstds/ti_ja/general/eStore/notice_01.page) 日本国内に輸入される評価用キット、ボードについては、次のところをご覧ください。

<https://www.ti.com/ja-jp/legal/notice-for-evaluation-kits-delivered-in-japan.html>

3.3.2 *Notice for Users of EVMs Considered "Radio Frequency Products" in Japan:* EVMs entering Japan may not be certified by TI as conforming to Technical Regulations of Radio Law of Japan.

If User uses EVMs in Japan, not certified to Technical Regulations of Radio Law of Japan, User is required to follow the instructions set forth by Radio Law of Japan, which includes, but is not limited to, the instructions below with respect to EVMs (which for the avoidance of doubt are stated strictly for convenience and should be verified by User):

1. Use EVMs in a shielded room or any other test facility as defined in the notification #173 issued by Ministry of Internal Affairs and Communications on March 28, 2006, based on Sub-section 1.1 of Article 6 of the Ministry's Rule for Enforcement of Radio Law of Japan,
2. Use EVMs only after User obtains the license of Test Radio Station as provided in Radio Law of Japan with respect to EVMs, or
3. Use of EVMs only after User obtains the Technical Regulations Conformity Certification as provided in Radio Law of Japan with respect to EVMs. Also, do not transfer EVMs, unless User gives the same notice above to the transferee. Please note that if User does not follow the instructions above, User will be subject to penalties of Radio Law of Japan.

【無線電波を送信する製品の開発キットをお使いになる際の注意事項】 開発キットの中には技術基準適合証明を受けていないものがあります。技術適合証明を受けていないものご使用に際しては、電波法遵守のため、以下のいずれかの措置を取っていただく必要がありますのでご注意ください。

1. 電波法施行規則第6条第1項第1号に基づく平成18年3月28日総務省告示第173号で定められた電波暗室等の試験設備でご使用いただく。
2. 実験局の免許を取得後ご使用いただく。
3. 技術基準適合証明を取得後ご使用いただく。

なお、本製品は、上記の「ご使用にあたっての注意」を譲渡先、移転先に通知しない限り、譲渡、移転できないものとします。

上記を遵守頂けない場合は、電波法の罰則が適用される可能性があることをご留意ください。日本テキサス・イ

ンスツルメンツ株式会社

東京都新宿区西新宿 6 丁目 2 4 番 1 号

西新宿三井ビル

3.3.3 *Notice for EVMs for Power Line Communication:* Please see [http://www.tij.co.jp/lstds/ti\\_ja/general/eStore/notice\\_02.page](http://www.tij.co.jp/lstds/ti_ja/general/eStore/notice_02.page)

電力線搬送波通信についての開発キットをお使いになる際の注意事項については、次のところをご覧ください。 <https://www.ti.com/ja-jp/legal/notice-for-evaluation-kits-for-power-line-communication.html>

#### 3.4 European Union

3.4.1 *For EVMs subject to EU Directive 2014/30/EU (Electromagnetic Compatibility Directive):*

This is a class A product intended for use in environments other than domestic environments that are connected to a low-voltage power-supply network that supplies buildings used for domestic purposes. In a domestic environment this product may cause radio interference in which case the user may be required to take adequate measures.

- 
4. *EVM Use Restrictions and Warnings:*
    - 4.1 EVMS ARE NOT FOR USE IN FUNCTIONAL SAFETY AND/OR SAFETY CRITICAL EVALUATIONS, INCLUDING BUT NOT LIMITED TO EVALUATIONS OF LIFE SUPPORT APPLICATIONS.
    - 4.2 User must read and apply the user guide and other available documentation provided by TI regarding the EVM prior to handling or using the EVM, including without limitation any warning or restriction notices. The notices contain important safety information related to, for example, temperatures and voltages.
    - 4.3 *Safety-Related Warnings and Restrictions:*
      - 4.3.1 User shall operate the EVM within TI's recommended specifications and environmental considerations stated in the user guide, other available documentation provided by TI, and any other applicable requirements and employ reasonable and customary safeguards. Exceeding the specified performance ratings and specifications (including but not limited to input and output voltage, current, power, and environmental ranges) for the EVM may cause personal injury or death, or property damage. If there are questions concerning performance ratings and specifications, User should contact a TI field representative prior to connecting interface electronics including input power and intended loads. Any loads applied outside of the specified output range may also result in unintended and/or inaccurate operation and/or possible permanent damage to the EVM and/or interface electronics. Please consult the EVM user guide prior to connecting any load to the EVM output. If there is uncertainty as to the load specification, please contact a TI field representative. During normal operation, even with the inputs and outputs kept within the specified allowable ranges, some circuit components may have elevated case temperatures. These components include but are not limited to linear regulators, switching transistors, pass transistors, current sense resistors, and heat sinks, which can be identified using the information in the associated documentation. When working with the EVM, please be aware that the EVM may become very warm.
      - 4.3.2 EVMs are intended solely for use by technically qualified, professional electronics experts who are familiar with the dangers and application risks associated with handling electrical mechanical components, systems, and subsystems. User assumes all responsibility and liability for proper and safe handling and use of the EVM by User or its employees, affiliates, contractors or designees. User assumes all responsibility and liability to ensure that any interfaces (electronic and/or mechanical) between the EVM and any human body are designed with suitable isolation and means to safely limit accessible leakage currents to minimize the risk of electrical shock hazard. User assumes all responsibility and liability for any improper or unsafe handling or use of the EVM by User or its employees, affiliates, contractors or designees.
    - 4.4 User assumes all responsibility and liability to determine whether the EVM is subject to any applicable international, federal, state, or local laws and regulations related to User's handling and use of the EVM and, if applicable, User assumes all responsibility and liability for compliance in all respects with such laws and regulations. User assumes all responsibility and liability for proper disposal and recycling of the EVM consistent with all applicable international, federal, state, and local requirements.
  5. *Accuracy of Information:* To the extent TI provides information on the availability and function of EVMs, TI attempts to be as accurate as possible. However, TI does not warrant the accuracy of EVM descriptions, EVM availability or other information on its websites as accurate, complete, reliable, current, or error-free.
  6. *Disclaimers:*
    - 6.1 EXCEPT AS SET FORTH ABOVE, EVMS AND ANY MATERIALS PROVIDED WITH THE EVM (INCLUDING, BUT NOT LIMITED TO, REFERENCE DESIGNS AND THE DESIGN OF THE EVM ITSELF) ARE PROVIDED "AS IS" AND "WITH ALL FAULTS." TI DISCLAIMS ALL OTHER WARRANTIES, EXPRESS OR IMPLIED, REGARDING SUCH ITEMS, INCLUDING BUT NOT LIMITED TO ANY EPIDEMIC FAILURE WARRANTY OR IMPLIED WARRANTIES OF MERCHANTABILITY OR FITNESS FOR A PARTICULAR PURPOSE OR NON-INFRINGEMENT OF ANY THIRD PARTY PATENTS, COPYRIGHTS, TRADE SECRETS OR OTHER INTELLECTUAL PROPERTY RIGHTS.
    - 6.2 EXCEPT FOR THE LIMITED RIGHT TO USE THE EVM SET FORTH HEREIN, NOTHING IN THESE TERMS SHALL BE CONSTRUED AS GRANTING OR CONFERRING ANY RIGHTS BY LICENSE, PATENT, OR ANY OTHER INDUSTRIAL OR INTELLECTUAL PROPERTY RIGHT OF TI, ITS SUPPLIERS/LICENSORS OR ANY OTHER THIRD PARTY, TO USE THE EVM IN ANY FINISHED END-USER OR READY-TO-USE FINAL PRODUCT, OR FOR ANY INVENTION, DISCOVERY OR IMPROVEMENT, REGARDLESS OF WHEN MADE, CONCEIVED OR ACQUIRED.
  7. *USER'S INDEMNITY OBLIGATIONS AND REPRESENTATIONS.* USER WILL DEFEND, INDEMNIFY AND HOLD TI, ITS LICENSORS AND THEIR REPRESENTATIVES HARMLESS FROM AND AGAINST ANY AND ALL CLAIMS, DAMAGES, LOSSES, EXPENSES, COSTS AND LIABILITIES (COLLECTIVELY, "CLAIMS") ARISING OUT OF OR IN CONNECTION WITH ANY HANDLING OR USE OF THE EVM THAT IS NOT IN ACCORDANCE WITH THESE TERMS. THIS OBLIGATION SHALL APPLY WHETHER CLAIMS ARISE UNDER STATUTE, REGULATION, OR THE LAW OF TORT, CONTRACT OR ANY OTHER LEGAL THEORY, AND EVEN IF THE EVM FAILS TO PERFORM AS DESCRIBED OR EXPECTED.
-

8. *Limitations on Damages and Liability:*

8.1 *General Limitations.* IN NO EVENT SHALL TI BE LIABLE FOR ANY SPECIAL, COLLATERAL, INDIRECT, PUNITIVE, INCIDENTAL, CONSEQUENTIAL, OR EXEMPLARY DAMAGES IN CONNECTION WITH OR ARISING OUT OF THESE TERMS OR THE USE OF THE EVMS , REGARDLESS OF WHETHER TI HAS BEEN ADVISED OF THE POSSIBILITY OF SUCH DAMAGES. EXCLUDED DAMAGES INCLUDE, BUT ARE NOT LIMITED TO, COST OF REMOVAL OR REINSTALLATION, ANCILLARY COSTS TO THE PROCUREMENT OF SUBSTITUTE GOODS OR SERVICES, RETESTING, OUTSIDE COMPUTER TIME, LABOR COSTS, LOSS OF GOODWILL, LOSS OF PROFITS, LOSS OF SAVINGS, LOSS OF USE, LOSS OF DATA, OR BUSINESS INTERRUPTION. NO CLAIM, SUIT OR ACTION SHALL BE BROUGHT AGAINST TI MORE THAN TWELVE (12) MONTHS AFTER THE EVENT THAT GAVE RISE TO THE CAUSE OF ACTION HAS OCCURRED.

8.2 *Specific Limitations.* IN NO EVENT SHALL TI'S AGGREGATE LIABILITY FROM ANY USE OF AN EVM PROVIDED HEREUNDER, INCLUDING FROM ANY WARRANTY, INDEMNITY OR OTHER OBLIGATION ARISING OUT OF OR IN CONNECTION WITH THESE TERMS, , EXCEED THE TOTAL AMOUNT PAID TO TI BY USER FOR THE PARTICULAR EVM(S) AT ISSUE DURING THE PRIOR TWELVE (12) MONTHS WITH RESPECT TO WHICH LOSSES OR DAMAGES ARE CLAIMED. THE EXISTENCE OF MORE THAN ONE CLAIM SHALL NOT ENLARGE OR EXTEND THIS LIMIT.

9. *Return Policy.* Except as otherwise provided, TI does not offer any refunds, returns, or exchanges. Furthermore, no return of EVM(s) will be accepted if the package has been opened and no return of the EVM(s) will be accepted if they are damaged or otherwise not in a resalable condition. If User feels it has been incorrectly charged for the EVM(s) it ordered or that delivery violates the applicable order, User should contact TI. All refunds will be made in full within thirty (30) working days from the return of the components(s), excluding any postage or packaging costs.

10. *Governing Law:* These terms and conditions shall be governed by and interpreted in accordance with the laws of the State of Texas, without reference to conflict-of-laws principles. User agrees that non-exclusive jurisdiction for any dispute arising out of or relating to these terms and conditions lies within courts located in the State of Texas and consents to venue in Dallas County, Texas. Notwithstanding the foregoing, any judgment may be enforced in any United States or foreign court, and TI may seek injunctive relief in any United States or foreign court.

Mailing Address: Texas Instruments, Post Office Box 655303, Dallas, Texas 75265  
Copyright © 2023, Texas Instruments Incorporated

## IMPORTANT NOTICE AND DISCLAIMER

TI PROVIDES TECHNICAL AND RELIABILITY DATA (INCLUDING DATA SHEETS), DESIGN RESOURCES (INCLUDING REFERENCE DESIGNS), APPLICATION OR OTHER DESIGN ADVICE, WEB TOOLS, SAFETY INFORMATION, AND OTHER RESOURCES "AS IS" AND WITH ALL FAULTS, AND DISCLAIMS ALL WARRANTIES, EXPRESS AND IMPLIED, INCLUDING WITHOUT LIMITATION ANY IMPLIED WARRANTIES OF MERCHANTABILITY, FITNESS FOR A PARTICULAR PURPOSE OR NON-INFRINGEMENT OF THIRD PARTY INTELLECTUAL PROPERTY RIGHTS.

These resources are intended for skilled developers designing with TI products. You are solely responsible for (1) selecting the appropriate TI products for your application, (2) designing, validating and testing your application, and (3) ensuring your application meets applicable standards, and any other safety, security, regulatory or other requirements.

These resources are subject to change without notice. TI grants you permission to use these resources only for development of an application that uses the TI products described in the resource. Other reproduction and display of these resources is prohibited. No license is granted to any other TI intellectual property right or to any third party intellectual property right. TI disclaims responsibility for, and you will fully indemnify TI and its representatives against, any claims, damages, costs, losses, and liabilities arising out of your use of these resources.

TI's products are provided subject to [TI's Terms of Sale](#) or other applicable terms available either on [ti.com](https://www.ti.com) or provided in conjunction with such TI products. TI's provision of these resources does not expand or otherwise alter TI's applicable warranties or warranty disclaimers for TI products.

TI objects to and rejects any additional or different terms you may have proposed.

Mailing Address: Texas Instruments, Post Office Box 655303, Dallas, Texas 75265  
Copyright © 2023, Texas Instruments Incorporated