

TPA3111D1EVM Audio Amplifier Evaluation Board

This user's guide provides the specifications, quick-start list for stand-alone operation, the schematic, bill of materials, and the board layout for the TPA3111DEVM evaluation module.

Contents

1	Introduction	2
1.1	TPA3111D1EVM Specifications	3
2	Operation	3
2.1	Quick-Start List for Stand-Alone Operation	3
3	Schematic, Layout, and Bill of Materials	5
3.1	TPA3111D1EVM Schematic	5
3.2	TPA3111D1EVM PCB Layers	6
3.3	TPA3111D1EVM Bill of Materials	7

List of Figures

1	TI TPA3111D1EVM Audio Power Amplifier – Top View	2
2	TI TPA3111D1EVM Audio Power Amplifier – Bottom View	2
3	TPA3111D1EVM Schematic.....	5
4	TPA3111D1EVM – Top Side Layout	6
5	TPA3111D1EVM – Bottom Side Layout	6

List of Tables

1	Key Parameters	3
2	Power Supply Requirements	4
3	TPA3111D1 Control Guide	4
4	Bill of Materials for TPA3111D1EVM	7

1 Introduction

The TPA3111D1EVM customer evaluation module (EVM) demonstrates the integrated circuit TPA3111D1 from Texas Instruments.

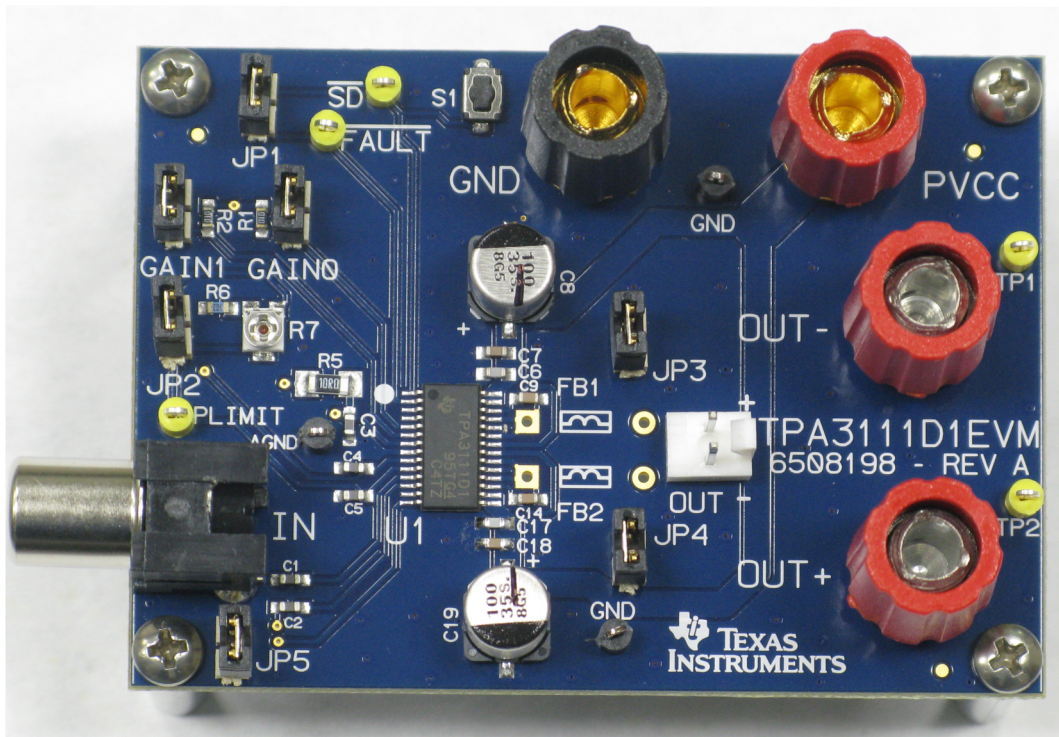

Figure 1. TI TPA3111D1EVM Audio Power Amplifier – Top View

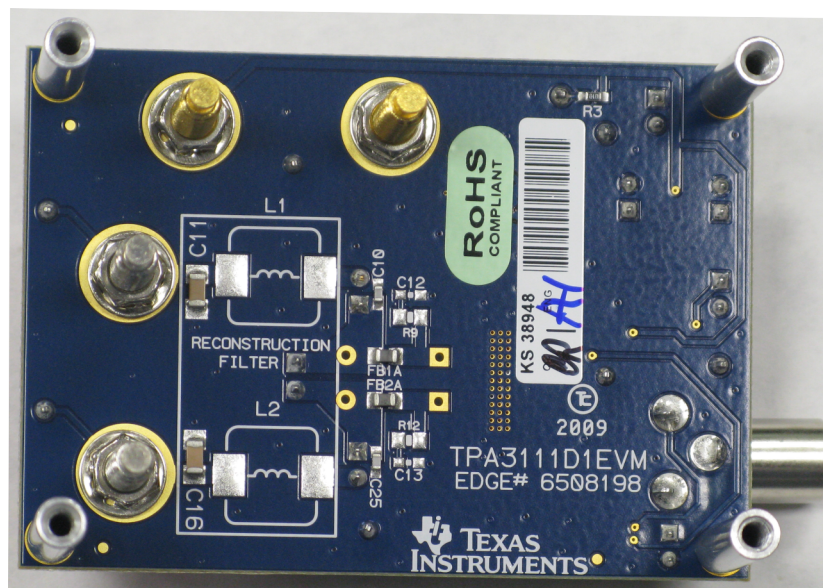

Figure 2. TI TPA3111D1EVM Audio Power Amplifier – Bottom View

1.1 TPA3111D1EVM Specifications

Table 1. Key Parameters

Key Parameters	
Power Supply Voltage	8 V to 26 V
Number of Channels	1 - Bridge-Tied Load (BTL) Mono
Load Impedance Mono BTL	4 Ω to 8 Ω (connect 33- μ H series inductor for 4- Ω , 68- μ H inductor or 8 Ω if using the ferrite bead filters)
Output Power	10 W

2 Operation

2.1 Quick-Start List for Stand-Alone Operation

Follow these steps to use the TPA3111D1EVM stand-alone or when connecting it into existing circuits or equipment. Connections to the EVM module can be made by inserting stripped wire or banana plugs for the power supply and output connections. The outputs also can be connected via Molex connectors. The input connectors are RCA phono jacks.

Power Supply

A single power supply is required to power up the EVM. Most of the pins are PVCC compliant. The PVCC supply can also be used to power the analog supply (AV_{CC}) and can be used to pull up the logic pins for shutdown (SD) control, fault detection (FAULT), and gain (GAIN0 and GAIN1) as long as the voltage slew rate is limited to 10 V/ms. GVDD is an internally generated supply for the output FETs and also can be used to power the PLIMIT circuit. PLIMIT is GVDD compliant, but not PVCC compliant. PLIMIT also can be powered by an external supply connected to the PLIMIT pin. Take care not to power the PLIMIT pin (or connect power to the GVDD pin inadvertently through the PLIMIT network) when the PVCC supply is turned off. This can cause damage to the integrated circuit (IC).

Table 2. Power Supply Requirements

Description	Voltage Range	Current Requirements	Minimum Wire Size
PVCC	8 to 26 V	3 A	24 AWG

1. Ensure that the external power source is set to OFF.
2. Connect the external regulated power supply adjusted from 8 V to 26 V to the module PVCC and GND banana jacks, taking care to observe marked polarity.

Evaluation Module Preparations

Inputs and Outputs

1. For a BTL configuration, connect a load across the outputs (OUT+ and OUT-).
2. Connect the audio input, either differential or single-ended, to the IN RCA phono plugs for BTL operation.

Control Inputs

1. Ensure that the mode jumpers, JP1, JP2, GAIN0, and GAIN1, are set correctly depending on the desired operating state ([Table 3](#)).

Power Up

1. Verify correct voltage and input polarity, and turn the external power supplies ON.
The EVM begins operation.
2. Adjust the audio source for the desired volume.

Table 3. TPA3111D1 Control Guide

Control	Function	Options	Notes
JP1	Allows amplifier to self-reset after short-circuit protection event	Insert jumper for self-reset. Leave off for latched SC fault.	For latched SC fault, cycle power to reset the fault latch. DC Detect does not recover with SDZ cycle. PVCC must be cycled to reset DC Detect.
GAIN1/GAIN0	Controls amplifier gain	Insert jumper for zero state (low). Leave off for one state (high).	00 = 20 dB (GAIN1, GAIN0) 01 = 26 dB 10 = 32 dB 11 = 36 dB
JP2	Defeats PLIMIT function and allows amplifier to run at full power.	Insert jumper for PLIMIT defeat.	JP2 connects PLIMIT directly to GVDD.
R7	Adjust PLIMIT (an external voltage also can be applied to the PLIMIT test point)	Remove JP2 to allow PLIMIT operation.	The output voltage rails are limited to approximately 4X the voltage at the PLIMIT pin. Take care not to apply power to PLIMIT when the PVCC source is off.
JP3, JP4	Connects LC filters to outputs.		

3 Schematic, Layout, and Bill of Materials

3.1 TPA311D1EVM Schematic

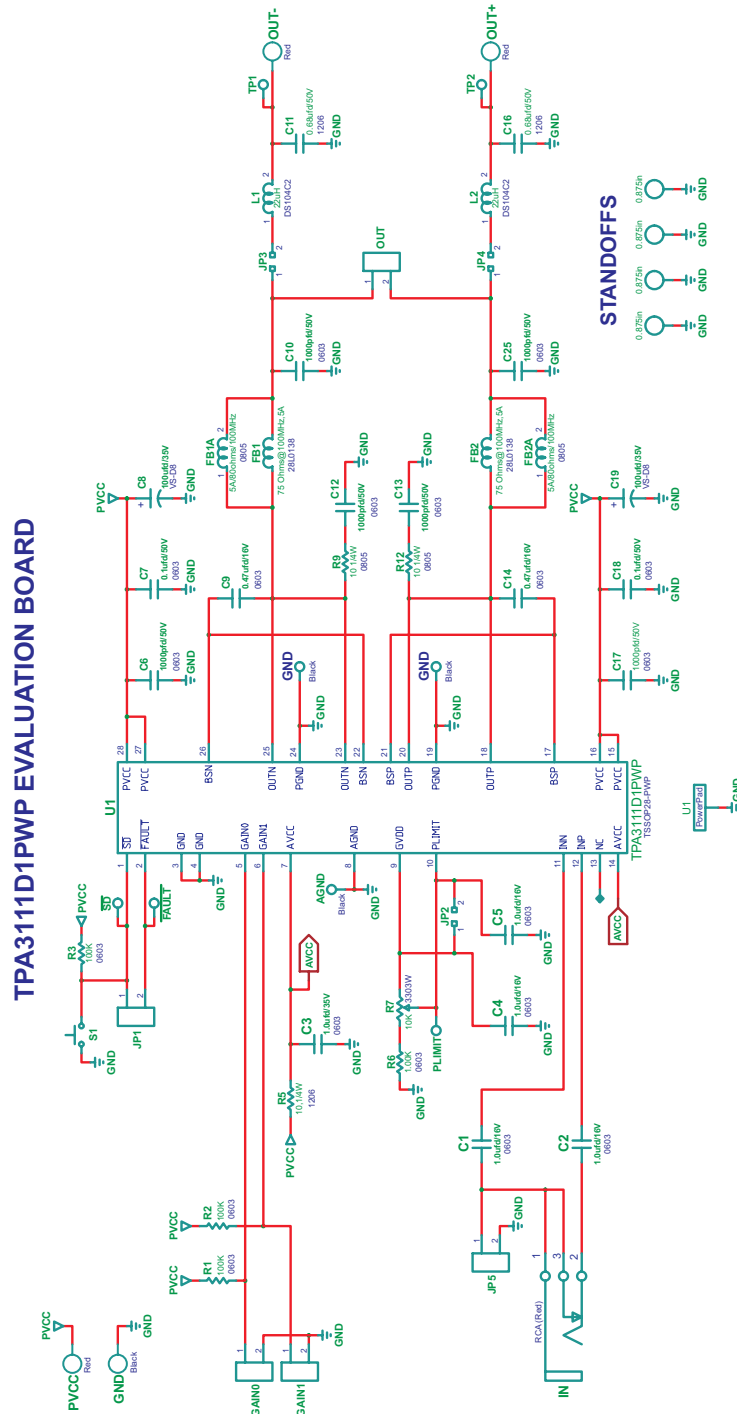

Figure 3. TPA311D1EVM Schematic

3.2 TPA3111D1EVM PCB Layers

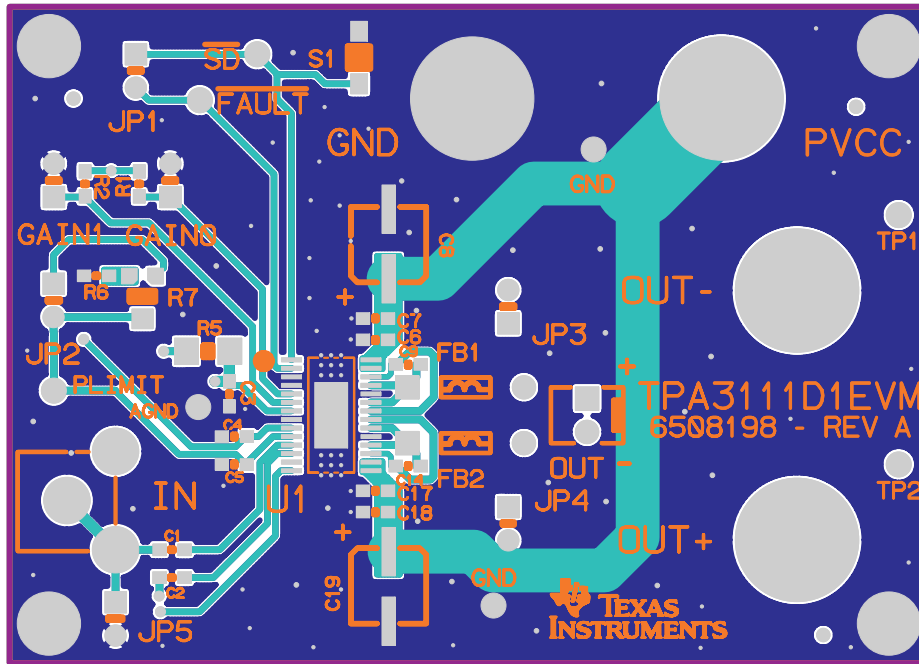

Figure 4. TPA3111D1EVM – Top Side Layout

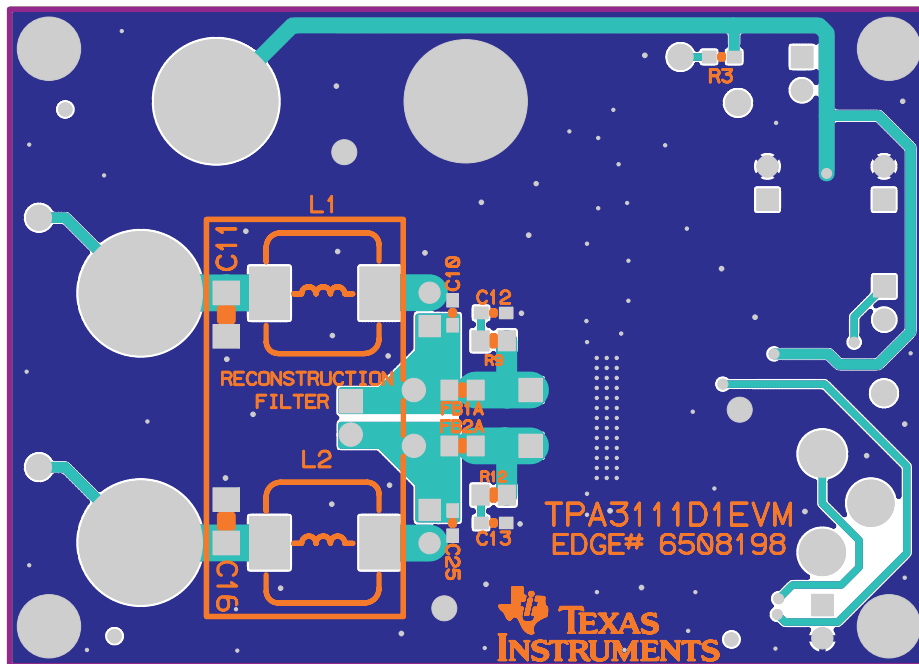

Figure 5. TPA3111D1EVM – Bottom Side Layout

3.3 TPA3111D1EVM Bill of Materials

Table 4. Bill of Materials for TPA3111D1EVM

Item	MANU Part no.	QTY	Ref Designators	Vendor Part No	Description	Vendor	MANU
TI-SEMICONDUCTORS							
1	TPA3111D1PWP	1	U1	TPA3111D1PWP	10-W MONO CLASS-D AUDIO POWER AMP, TSSOP28-PWP ROHS	TEXAS INSTRUMENTS	TEXAS INSTRUMENTS
CAPACITORS							
2	C1608C0G1H102J	6	C6,C10,C12,C13,C17,C25	445-1293-1	CAP SMD0603 CERM 1000 pF 50V 5% COG ROHS	DIGI-KEY	TDK CORP.
3	C1608X7R1H104K	2	C7,C18	445-1314-1	CAP SMD0603 CERM 0.1 μ F 50V X7R ROHS	DIGI-KEY	TDK
4	0603YD474KAT2A	2	C9,C14	478-1248-1	CAP SMD0603 CERM 0.47 μ F 16V 10% X5R ROHS	DIGI-KEY	AVX
5	C1206C684K5RACTU	2	C11,C16	399-3500-1	CAP SMD1206 CERM 0.68 μ F 50V 10% X7R ROHS	DIGI-KEY	KEMET
6	C0603C105K4PACTU	4	C1,C2,C4,C5	399-5090-1	CAP SMD0603 CERM 1.0 μ F 16V 10% X5R ROHS	DIGI-KEY	KEMET
7	GMK107BJ105KA-T	1	C3	587-1437-1	CAP SMD0603 CERM 1.0 μ F 35V 10% X5R ROHS	DIGI-KEY	TAIYO YUDEN
8	EEE-1VA101XP	2	C8,C19	PCE3951CT	CAP SMD ELECT 100 μ F 35V 20% VS-D8 ROHS	DIGI-KEY	PANASONIC
RESISTORS							
9	ESR10EZPJ100	2	R9,R12	RHM10KCT	RESISTOR SMD0805 10 Ω 1% 1/4W ROHS	DIGI-KEY	ROHM
10	ERJ-8ENF10R0	1	R5	P10.0FCT	RESISTOR SMD1206 10.0 Ω 1% 1/4W ROHS	DIGI-KEY	PANASONIC
11	RC0603FR-071KL	1	R6	311-1.00KHRCT	RESISTOR SMD0603 1.00K Ω 1% 1/10W ROHS	DIGI-KEY	YAGEO
12	3303W-3-103E	1	R7	3303W-103ECT	POT SMD SINGLE TURN CERMET10K ROHS	DIGI-KEY	BOURNS
13	ERJ-3EKF1003V	3	R1,R2,R3	P100KHCT	RESISTOR SMD0603 100K Ω 1% 1/16W ROHS	DIGI-KEY	PANASONIC
FERRITE BEADS AND INDUCTORS							
14	HI0805R800R-10	2	FB1A,FB2A	240-2395-1	FERRITE BEAD SMD0805 80 Ω @100MHz 5A ROHS	DIGI-KEY	STEWART
15	28L0138-10R-10	2	FB1,FB2	240-2438-1	FERRITE BEAD THRU RN50 75 Ω @100MHz 5A ROHS	DIGI-KEY	STEWART
16	B952AS-220M	2	L1,L2	B952AS-220M	INDUCTOR SMT 22 μ H 2.4A 87 Ω 20% DS104C2 ROHS	TOKO JAPAN	TOKO JAPAN
HEADERS AND JACKS							
17	PBC02SAAN	7	JP1, JP2, JP3, JP4, JP5, GAIN0, GAIN1	S1011E-02	HEADER 2 PIN MALE, PCB STRAIGHT GOLD ROHS	DIGI-KEY	SULLINS

Table 4. Bill of Materials for TPA3111D1EVM (continued)

Item	MANU Part no.	QTY	Ref Designators	Vendor Part No	Description	Vendor	MANU
18	22-23-2021	1	OUT	WM4200	HEADER MALE 2PIN 100LS W/ FRICTION LOCK ROHS	DIGI-KEY	MOLEX
19	PJРАН1X1U03X	1	IN	89K7617	JACK, RCA 3-PIN PCB-RA RED ROHS	NEWARK	SWITCHCRAFT
TESTPOINTS AND SWITCHES							
20	5004	5	SD, FAULT, PLIMIT, TP1 TP2	5004K	PC TESTPOINT, YELLOW, ROHS	DIGI-KEY	KEYSTONE ELECTRONICS
21	5001	3	AGND, GND, GND	5001K	PC TESTPOINT, BLACK, ROHS	DIGI-KEY	KEYSTONE ELECTRONICS
22	TL1015AF160QG	1	S1	EG4344CT	SWITCH, MOM, 160G SMT 4X3MM ROHS	DIGI-KEY	E-SWITCH
BINDING POSTS							
23	3760-2	2	OUT+, OUT-	565-3760-2	BINDING POST, RED 60V/15A TIN ROHS	MOUSER	POMONA
24	3750-2	1	PVCC	565-3750-2	BINDING POST, RED 60V/15A GOLD ROHS	MOUSER	POMONA
25	3750-0	1	GND	565-3750-0	BINDING POST, BLACK 60V/15A GOLD ROHS	MOUSER	POMONA
SHUNTS							
26	SPC02SYAN	7	JP1, JP2, JP3, JP4, JP5, GAIN0, GAIN1	S9001	SHUNT, BLACK AU FLASH 0.100LS	DIGI-KEY	SULLINS
STANDOFFS AND HARDWARE							
27	PMS 440 0025 PH	4	SO1,SO2,SO3,SO4	H342	4-40 SCREW, STEEL 0.250 IN	DIGI-KEY	BUILDING FASTENERS
28	2030	4	SO1,SO2,SO3,SO4	2030K	STANDOFF, 4-40, 0.875IN x 3/16IN, ALUM RND F-F	DIGI-KEY	KEYSTONE
COMPONENTS NOT ASSEMBLED							
FB1, FB2							
COMPONENTS MISSING FROM SEQUENCE							
C15, C20-C24, R4, R8, R10, R11							

Evaluation Board/Kit Important Notice

Texas Instruments (TI) provides the enclosed product(s) under the following conditions:

This evaluation board/kit is intended for use for **ENGINEERING DEVELOPMENT, DEMONSTRATION, OR EVALUATION PURPOSES ONLY** and is not considered by TI to be a finished end-product fit for general consumer use. Persons handling the product(s) must have electronics training and observe good engineering practice standards. As such, the goods being provided are not intended to be complete in terms of required design-, marketing-, and/or manufacturing-related protective considerations, including product safety and environmental measures typically found in end products that incorporate such semiconductor components or circuit boards. This evaluation board/kit does not fall within the scope of the European Union directives regarding electromagnetic compatibility, restricted substances (RoHS), recycling (WEEE), FCC, CE or UL, and therefore may not meet the technical requirements of these directives or other related directives.

Should this evaluation board/kit not meet the specifications indicated in the User's Guide, the board/kit may be returned within 30 days from the date of delivery for a full refund. **THE FOREGOING WARRANTY IS THE EXCLUSIVE WARRANTY MADE BY SELLER TO BUYER AND IS IN LIEU OF ALL OTHER WARRANTIES, EXPRESSED, IMPLIED, OR STATUTORY, INCLUDING ANY WARRANTY OF MERCHANTABILITY OR FITNESS FOR ANY PARTICULAR PURPOSE.**

The user assumes all responsibility and liability for proper and safe handling of the goods. Further, the user indemnifies TI from all claims arising from the handling or use of the goods. Due to the open construction of the product, it is the user's responsibility to take any and all appropriate precautions with regard to electrostatic discharge.

EXCEPT TO THE EXTENT OF THE INDEMNITY SET FORTH ABOVE, NEITHER PARTY SHALL BE LIABLE TO THE OTHER FOR ANY INDIRECT, SPECIAL, INCIDENTAL, OR CONSEQUENTIAL DAMAGES.

TI currently deals with a variety of customers for products, and therefore our arrangement with the user **is not exclusive.**

TI assumes **no liability for applications assistance, customer product design, software performance, or infringement of patents or services described herein.**

Please read the User's Guide and, specifically, the Warnings and Restrictions notice in the User's Guide prior to handling the product. This notice contains important safety information about temperatures and voltages. For additional information on TI's environmental and/or safety programs, please contact the TI application engineer or visit www.ti.com/esh.

No license is granted under any patent right or other intellectual property right of TI covering or relating to any machine, process, or combination in which such TI products or services might be or are used.

FCC Warning

This evaluation board/kit is intended for use for **ENGINEERING DEVELOPMENT, DEMONSTRATION, OR EVALUATION PURPOSES ONLY** and is not considered by TI to be a finished end-product fit for general consumer use. It generates, uses, and can radiate radio frequency energy and has not been tested for compliance with the limits of computing devices pursuant to part 15 of FCC rules, which are designed to provide reasonable protection against radio frequency interference. Operation of this equipment in other environments may cause interference with radio communications, in which case the user at his own expense will be required to take whatever measures may be required to correct this interference.

EVM Warnings and Restrictions

It is important to operate this EVM within the input voltage range of -0.3 V to 6.3 V and the output voltage range of -0.3 V to 30 V . Exceeding the specified input range may cause unexpected operation and/or irreversible damage to the EVM. If there are questions concerning the input range, please contact a TI field representative prior to connecting the input power.

Applying loads outside of the specified output range may result in unintended operation and/or possible permanent damage to the EVM. Please consult the EVM User's Guide prior to connecting any load to the EVM output. If there is uncertainty as to the load specification, please contact a TI field representative.

During normal operation, some circuit components may have case temperatures greater than 85° C. The EVM is designed to operate properly with certain components above 85° C as long as the input and output ranges are maintained. These components include but are not limited to linear regulators, switching transistors, pass transistors, and current sense resistors. These types of devices can be identified using the EVM schematic located in the EVM User's Guide. When placing measurement probes near these devices during operation, please be aware that these devices may be very warm to the touch.

Mailing Address: Texas Instruments, Post Office Box 655303, Dallas, Texas 75265
Copyright © 2010, Texas Instruments Incorporated

IMPORTANT NOTICE

Texas Instruments Incorporated and its subsidiaries (TI) reserve the right to make corrections, modifications, enhancements, improvements, and other changes to its products and services at any time and to discontinue any product or service without notice. Customers should obtain the latest relevant information before placing orders and should verify that such information is current and complete. All products are sold subject to TI's terms and conditions of sale supplied at the time of order acknowledgment.

TI warrants performance of its hardware products to the specifications applicable at the time of sale in accordance with TI's standard warranty. Testing and other quality control techniques are used to the extent TI deems necessary to support this warranty. Except where mandated by government requirements, testing of all parameters of each product is not necessarily performed.

TI assumes no liability for applications assistance or customer product design. Customers are responsible for their products and applications using TI components. To minimize the risks associated with customer products and applications, customers should provide adequate design and operating safeguards.

TI does not warrant or represent that any license, either express or implied, is granted under any TI patent right, copyright, mask work right, or other TI intellectual property right relating to any combination, machine, or process in which TI products or services are used. Information published by TI regarding third-party products or services does not constitute a license from TI to use such products or services or a warranty or endorsement thereof. Use of such information may require a license from a third party under the patents or other intellectual property of the third party, or a license from TI under the patents or other intellectual property of TI.

Reproduction of TI information in TI data books or data sheets is permissible only if reproduction is without alteration and is accompanied by all associated warranties, conditions, limitations, and notices. Reproduction of this information with alteration is an unfair and deceptive business practice. TI is not responsible or liable for such altered documentation. Information of third parties may be subject to additional restrictions.

Resale of TI products or services with statements different from or beyond the parameters stated by TI for that product or service voids all express and any implied warranties for the associated TI product or service and is an unfair and deceptive business practice. TI is not responsible or liable for any such statements.

TI products are not authorized for use in safety-critical applications (such as life support) where a failure of the TI product would reasonably be expected to cause severe personal injury or death, unless officers of the parties have executed an agreement specifically governing such use. Buyers represent that they have all necessary expertise in the safety and regulatory ramifications of their applications, and acknowledge and agree that they are solely responsible for all legal, regulatory and safety-related requirements concerning their products and any use of TI products in such safety-critical applications, notwithstanding any applications-related information or support that may be provided by TI. Further, Buyers must fully indemnify TI and its representatives against any damages arising out of the use of TI products in such safety-critical applications.

TI products are neither designed nor intended for use in military/aerospace applications or environments unless the TI products are specifically designated by TI as military-grade or "enhanced plastic." Only products designated by TI as military-grade meet military specifications. Buyers acknowledge and agree that any such use of TI products which TI has not designated as military-grade is solely at the Buyer's risk, and that they are solely responsible for compliance with all legal and regulatory requirements in connection with such use.

TI products are neither designed nor intended for use in automotive applications or environments unless the specific TI products are designated by TI as compliant with ISO/TS 16949 requirements. Buyers acknowledge and agree that, if they use any non-designated products in automotive applications, TI will not be responsible for any failure to meet such requirements.

Following are URLs where you can obtain information on other Texas Instruments products and application solutions:

Products		Applications	
Amplifiers	amplifier.ti.com	Audio	www.ti.com/audio
Data Converters	dataconverter.ti.com	Automotive	www.ti.com/automotive
DLP® Products	www.dlp.com	Communications and Telecom	www.ti.com/communications
DSP	dsp.ti.com	Computers and Peripherals	www.ti.com/computers
Clocks and Timers	www.ti.com/clocks	Consumer Electronics	www.ti.com/consumer-apps
Interface	interface.ti.com	Energy	www.ti.com/energy
Logic	logic.ti.com	Industrial	www.ti.com/industrial
Power Mgmt	power.ti.com	Medical	www.ti.com/medical
Microcontrollers	microcontroller.ti.com	Security	www.ti.com/security
RFID	www.ti-rfid.com	Space, Avionics & Defense	www.ti.com/space-avionics-defense
RF/IF and ZigBee® Solutions	www.ti.com/lprf	Video and Imaging	www.ti.com/video
		Wireless	www.ti.com/wireless-apps