

Texas Instruments		
Title	TPS62110 Power	
Size	Number	Rev
B	PMP4024	A
Date	8/26/08	Drawn by
Filename	PMP4024REVB.sch	Sheet of

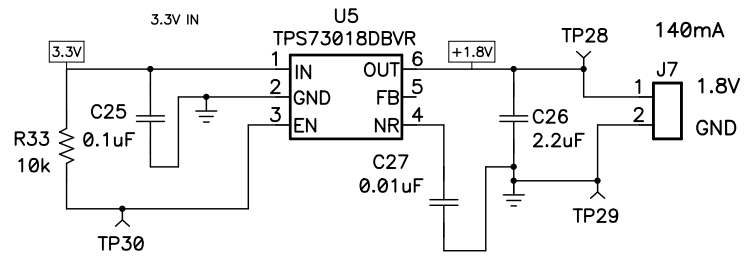

From PM 2807

Texas Instruments		
Title	TPS73018 Power	
Size	Number	Rev
B	PMP4024	A
Date	8/26/08	Drawn by: Olabumuyi
Filename	PMP4024_REV B	Sheet of

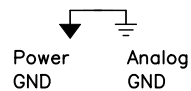
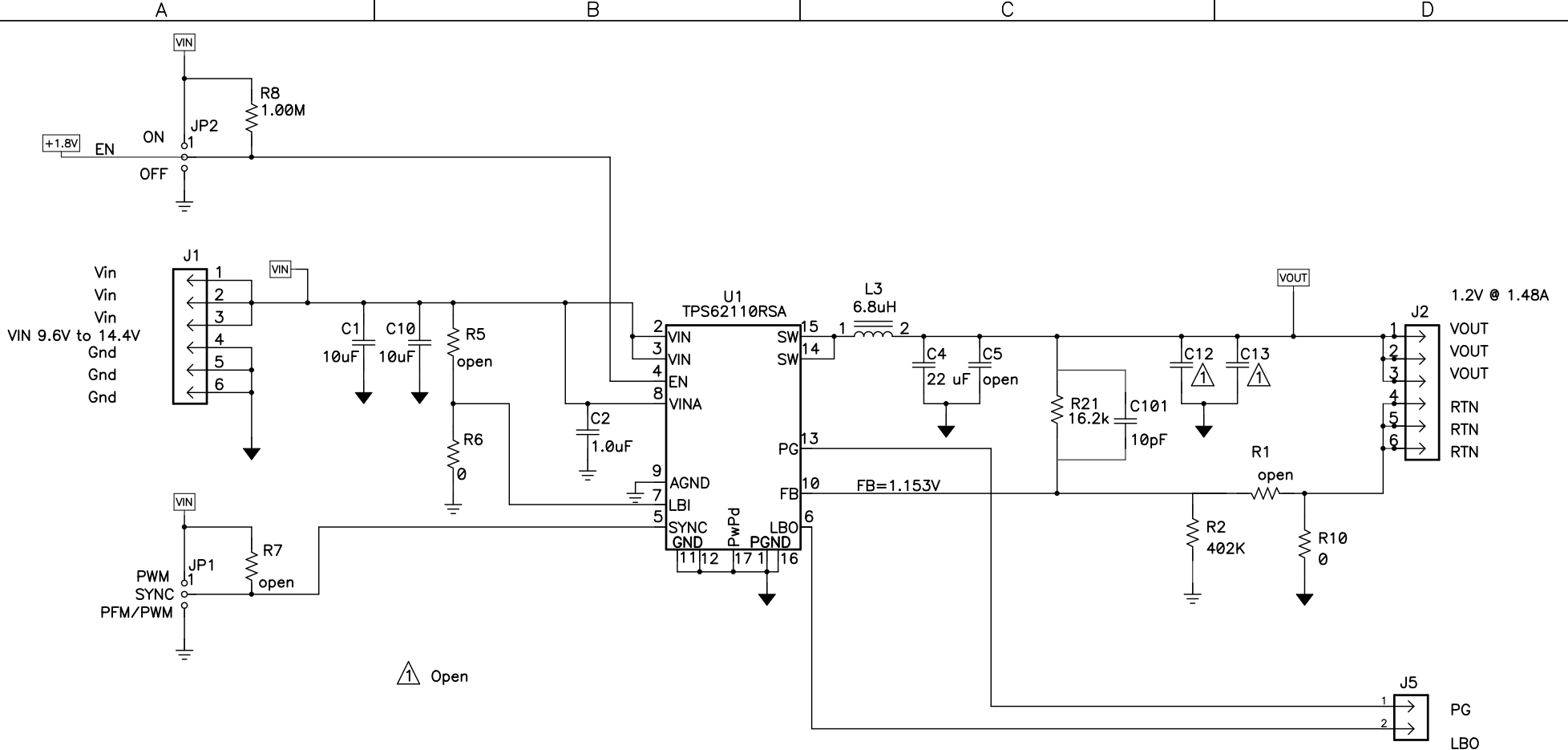

Texas Instruments		
Title	TPS62110 Power	
Size	Number	Rev
B	PMP4024	A
Date	8/26/08	Drawn by T. Olabumuyi
Filename	PMP4024REV.B.sch	Sheet of

### PMP4024REVB BOM

COUNT	RefDes	Value	Description	Size	Part Number	MFR
<b>1.2V and 3.3V SWIFT</b>						
4	C1, C8, C10, C11	10uF	Capacitor, Ceramic, 25V, X5R, 20%	1206	C3216X5R1E106	TDK
1	C101	10pF	Capacitor, Ceramic, 10-pF, 50-V, C0G, 5%	0603	C1608C0G1H100DB	TDK
	C12, C13, C14,					
4	C15	Open	Capacitor, Ceramic, 10V, X5R, 20%	1206	Std	Std
2	C2, C3	1.0uF	Capacitor, Ceramic, 25V, X7R, 10%	0603	C1608X7R1E105K	TDK
3	C4, C6, C7	22 uF	Capacitor, Ceramic, 10V, X5R, 20%	1206	C3216X5R1A226	TDK
1	C5	open	Capacitor, Ceramic, open, 10V, X5R, 20%	1206	C3216X5R1A226	TDK
1	C9	10pF	Capacitor, Ceramic, 50V, C0G, 5%	0603	C1608C0G1H100DB	TDK
4	J1, J2, J3, J4	PTC36SAAN	Header, Male 6-pin, 100mil spacing, (36-pin strip)	0.100 inch x 6	PTC36SAAN	Sullins
2	J5, J8	PTC36SAAN	Header, 2-pin, 100mil spacing, (36-pin strip)	0.100 x 2	PTC36SAAN	Sullins
4	JP1, JP2, JP3, JP4	PTC36SAAN	Header, 3-pin, 100mil spacing, (36-pin strip)	0.100 x 3	PTC36SAAN	Sullins
2	L1, L2	6.8uH	Inductor, SMT, 3.67A, 41.8 milliohm	0.276 x 0.276 inch	DR74-6R8-R	Coiltronics
	R1, R5, R7, R13,					
5	R15	open	Resistor, Chip, open, 1/16-W, 1%	0603	Std	Std
1	R10	0	Resistor, Chip, short, 1/2W, 1%	1206	CRCW1206R510FKEA	Vishay
1	R18	562K	Resistor, Chip, 562k, 1/16-W, 1%	0603	Std	Std
1	R2	402K	Resistor, Chip, 402K, 1/16-W, 1%	0603	Std	Std
1	R20	Open	Resistor, Chip, 1/16-W, 1%	0603	Std	Std
1	R21	16.2k	Resistor, Chip, 16.2k, 1/16-W, 1%	0603	Std	Std
1	R4	301K	Resistor, Chip, 301k, 1/16-W, 1%	0603	Std	Std
2	R6, R14	0	Resistor, Chip, short, 1/16-W, 1%	0603	Std	Std
3	R8, R16, R17	1.00M	Resistor, Chip, 1/16-W, 1%	0603	Std	Std
2	SH1, SH2		Short jumper			
2	U1, U2	TPS62110RSA	IC, Synchronous Step-Down Converter, 17V, 1.2A	QFN-16	TPS62110RSA	TI
<b>1.8V LDO</b>						
1	C25	0.1uF	Capacitor, Ceramic, 0.1-uF, 50-V, X7R, 15%	0603	Std	TDK
1	C26	2.2uF	Capacitor, Ceramic, 16V, X7R	0805	std	std
1	C27	0.01uF	Capacitor, Ceramic, 0.01uF, 50-V, X7R, 15%	0603	Std	TDK
1	J7	ED1609-ND	Terminal Block, 2-pin, 15-A, 5.1mm	0.40 x 0.35	ED1609	
1	R33	10k	Resistor, Chip, 1/16W, 1%	0603	Std	Std
2	TP28, TP30	5000	Test Point, Red, Thru Hole Color Keyed	0.100 x 0.100 inch	5000	Keystone
1	TP29	5001	Test Point, Black, Thru Hole Color Keyed	0.100 x 0.100 inch	5001	Keystone
1	U5	TPS73018DBVR	IC, UltraLow-Noise, High PSRR, Fast RF 200 mA, LDO Regulæ SOT23-6		TPS73018DBVR	TI



## DM643x – TPS62110 & TPS73018 - (PMP4024-RevB) 9/15/08

The following test report includes measurements for the following output voltage rails using a **12V input**:

- A. **Start Up Waveform for all outputs**
- B. **1.2V @ 1.48A Using the TPS62110 Device**
  - 1. Output Voltage Ripple (Measured Full Load)
  - 2. Load Transient (25% to 100% Load Step)
  - 3. Load Regulation
  - 4. Efficiency
  - 5. Switch Node
- C. **3.3V @ 0.18A Using the TPS62110 Device**
  - 1. Output Voltage Ripple (Measured Full Load)
  - 2. Load Transient (25% to 100% Load Step)
  - 3. Load Regulation
  - 4. Efficiency
  - 5. Switch Node
- D. **1.8V @ 0.14A Using the TPS73018 Device - LDO**
  - 1. Output Voltage Ripple (Measured Full Load)
  - 2. Load Transient (25% to 100% Load Step)

## A Start Up Waveform All Outputs – TPS 62110 & TPS73018

Sequence is 3.3V, 1.8V and 1.2V, with 12Vin

Channel 2: 3.3V DC/DC –green - TPS62110 – 2V/Div

Channel 1: 1.8V LDO – orange - TPS 73018 -2V/Div

Channel 3: 1.2V DC/DC – red - TPS62110 -2V/Div

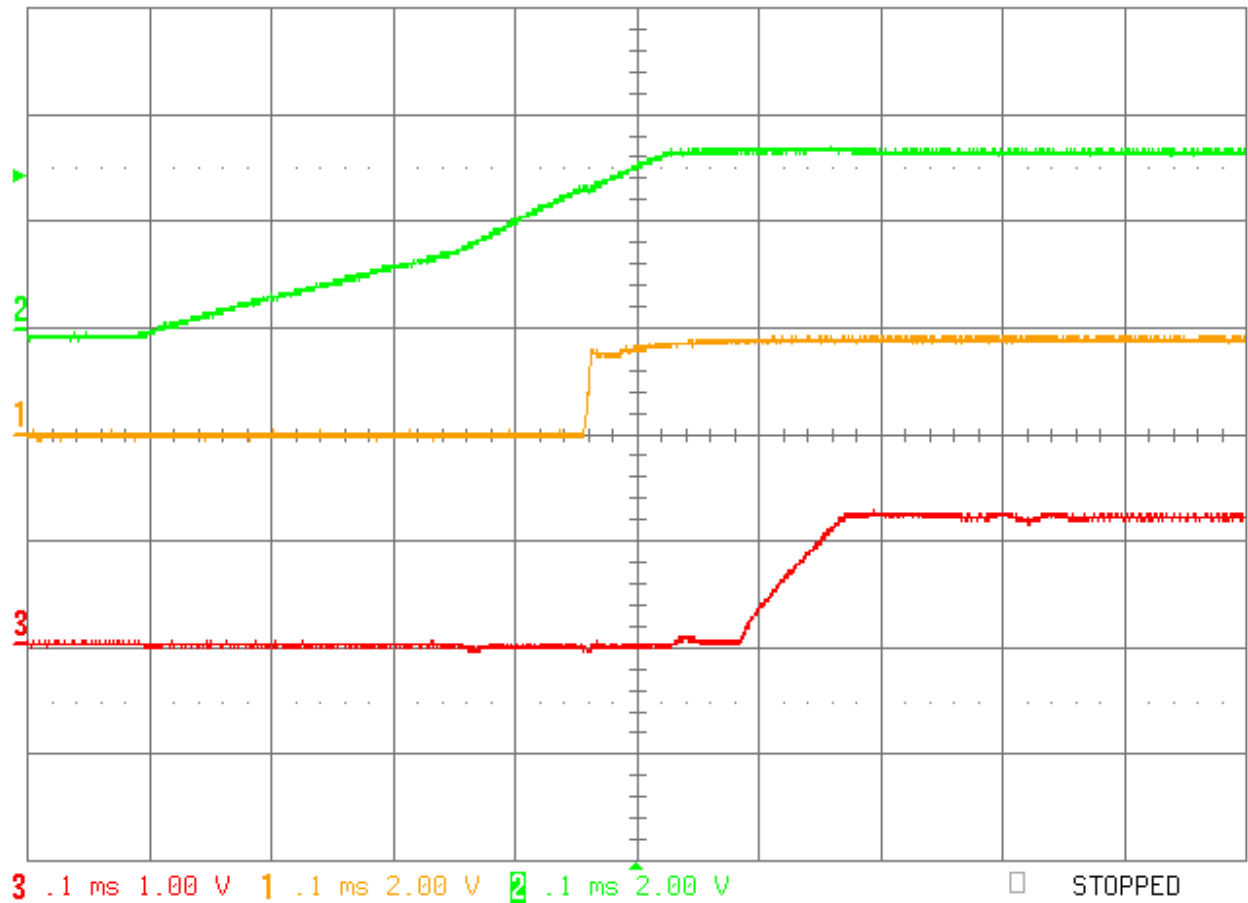

## B. 1.2V @ 1.48A – TPS 62110 – DCDC

### 1 Output Ripple Voltage for 1.2V @ 1.48A (TPS62110)

The photo below shows the output voltage ripple. The input voltage is 12V.

Channel 1: 1.2V Output - Orange (20mV/Division; AC Coupled)

Channel 2: 1.2V Output – Green (1V/Division, DC Coupled)

Channel 4: Output Current – Blue (1A/Division, DC Coupled)

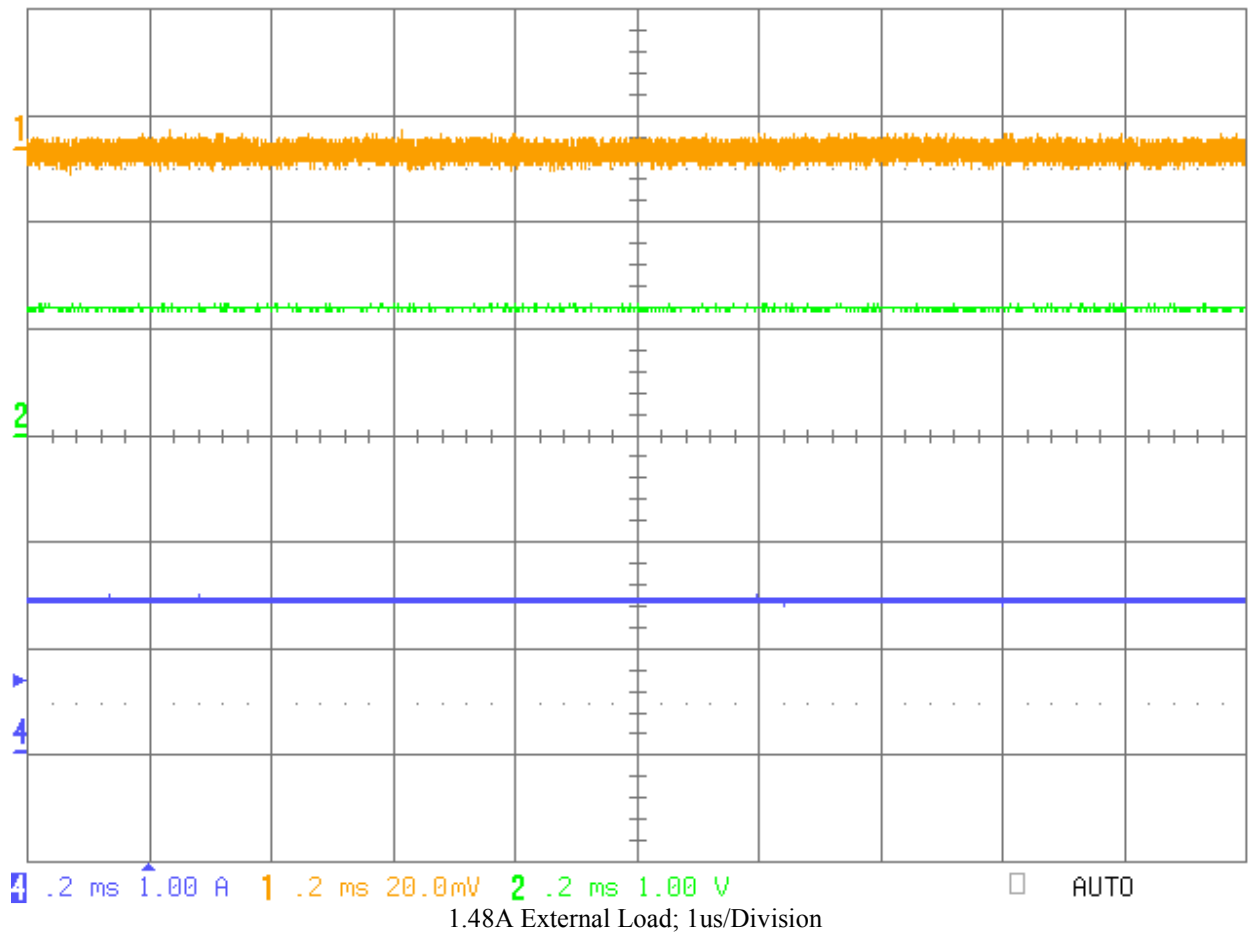

## 2 Load Transients – 1.2V @ 1.48A (TPS62110) 25% to 100% Load Step

The photo below shows the transient response. The current is pulsed from 0.37A to 1.48A. The input voltage is 12V. The time-base is set to 200us/Division.

Channel 1: 1.2V Output - Orange (50mV/Division; AC Coupled)

Channel2: 1.2V Output – Green (1V/Division, DC Coupled)

Channel 4: Output Current - Blue (1A/Division)

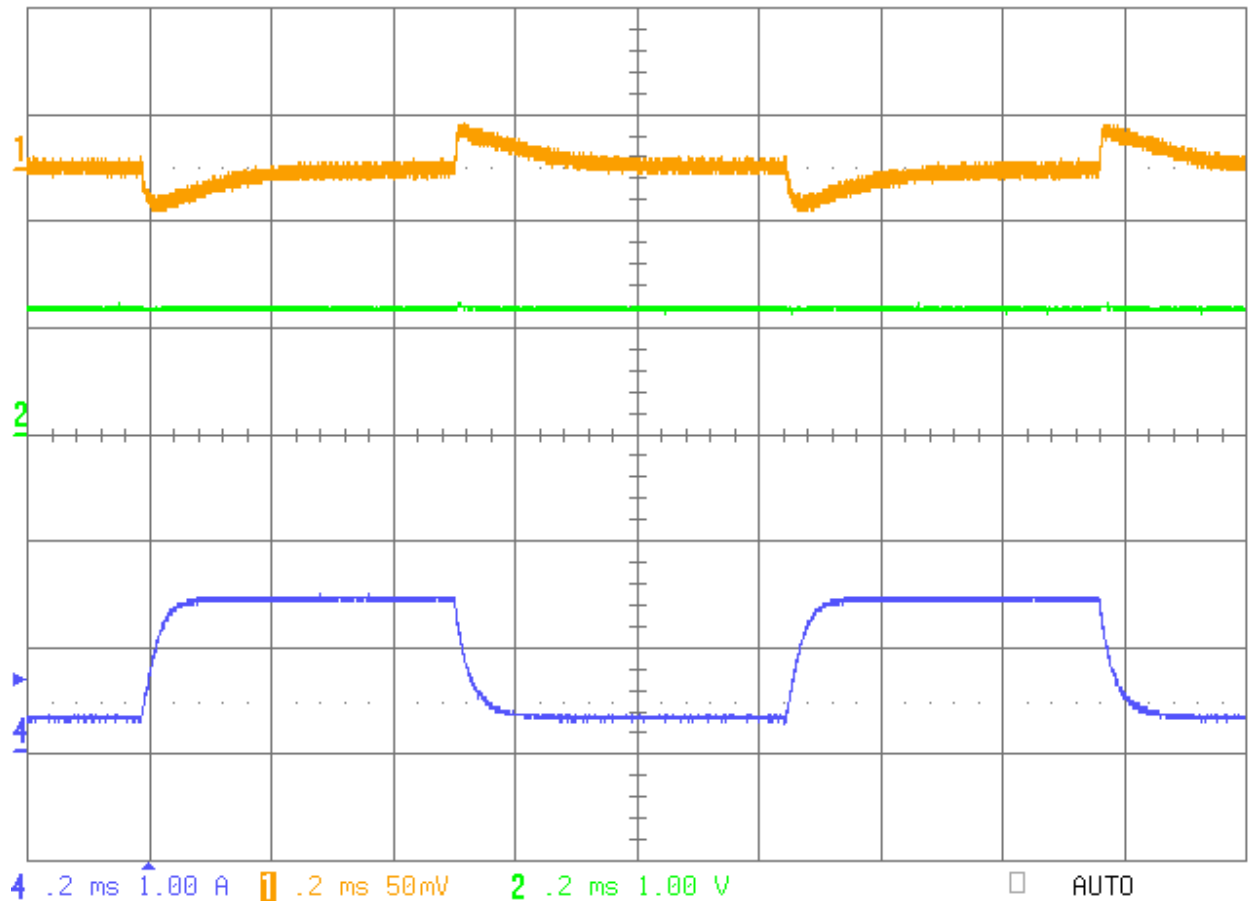



### 3 Load Regulation (TPS62110)

The load regulation is shown in the figure below. The input voltage is 12V.

#### 1.2V@1.48A Output Voltage vs. Load Current

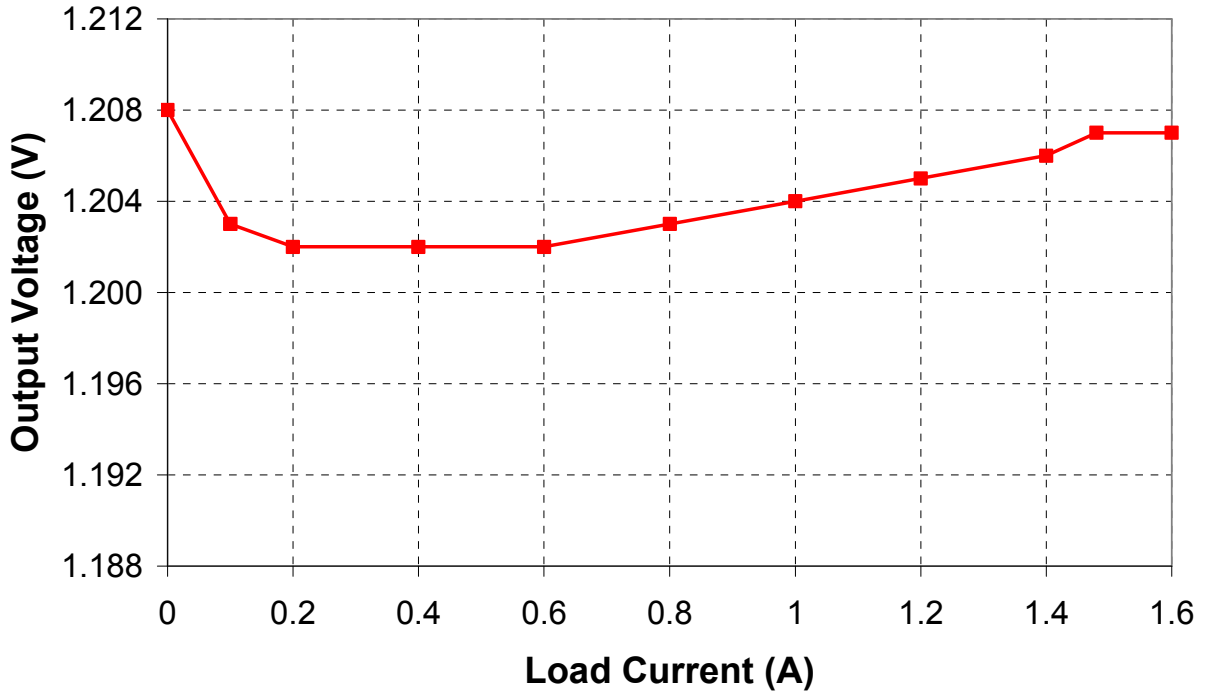

#### 4 Efficiency (TPS62110)

The efficiency is shown in the figure below. The input voltage is 12V.

### 1.2V@1.48A Efficiency vs. Load Current

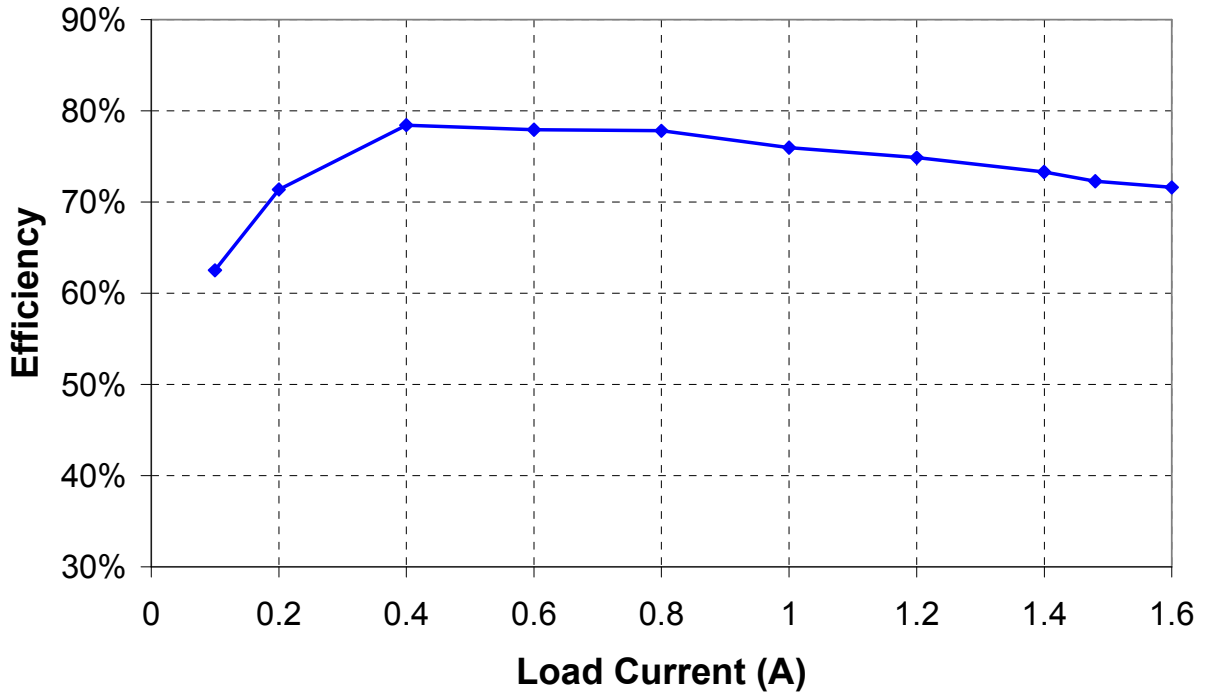

## 5 Switch Node Waveforms 1.2V @ 1.48A (TPS62110)

The plot below shows the switching waveforms for the converter. The input is 12V.

Channel 1: Switch Node - Orange (10V/Division)

)

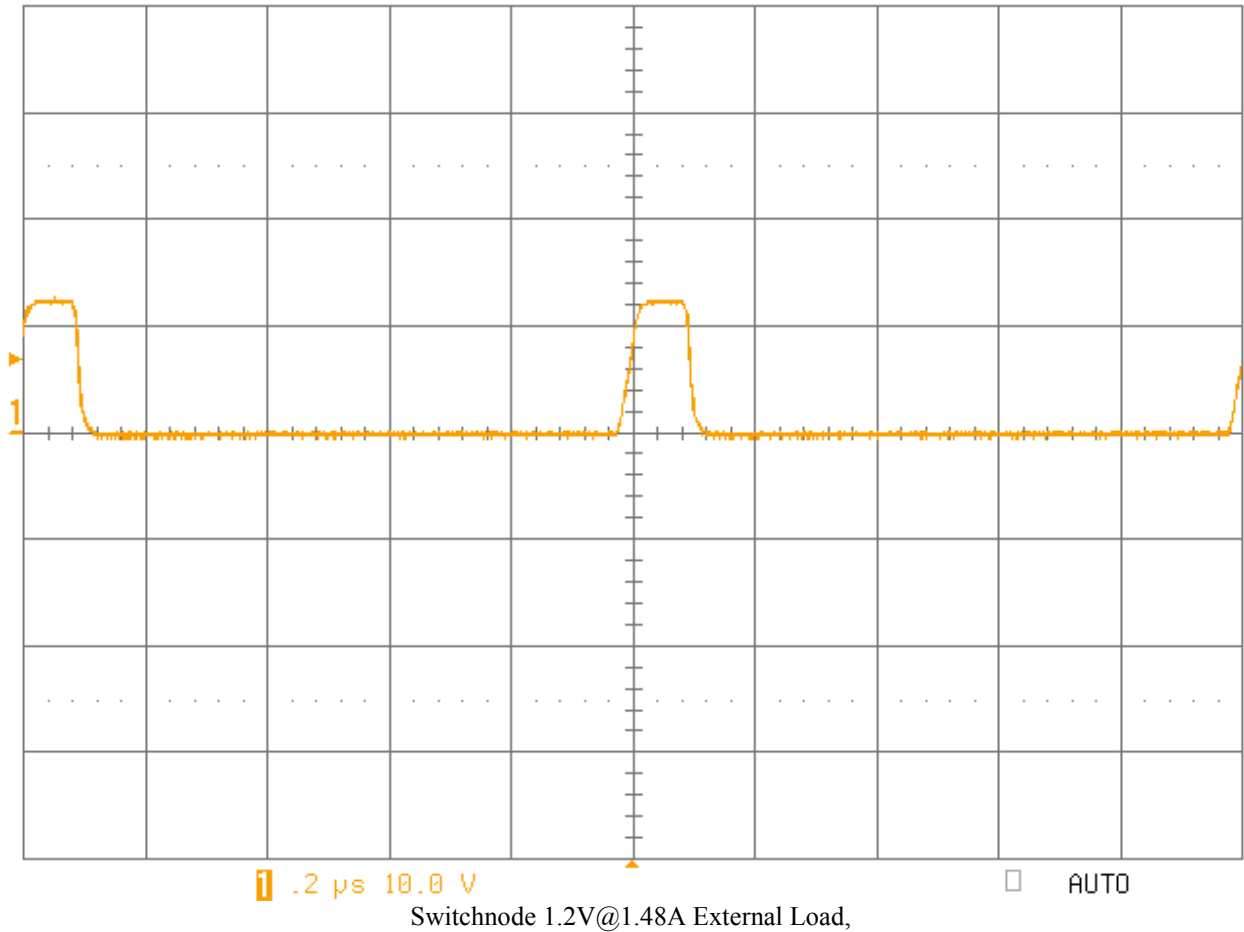

### C. 3.3V @ 0.18A – TPS 62110 – DCDC

#### 1 Output Ripple Voltage for 3.3V @ 0.18A (TPS62110)

The photo below shows the output voltage ripple. The input voltage is 12V.

Channel 1: 3.3V Output - Orange (20mV/Division; AC Coupled)

Channel 3: 3.3V Output – Green (2V/Division, DC Coupled)

Channel 4: Output Current – Blue (100 mA/Division, DC Coupled)

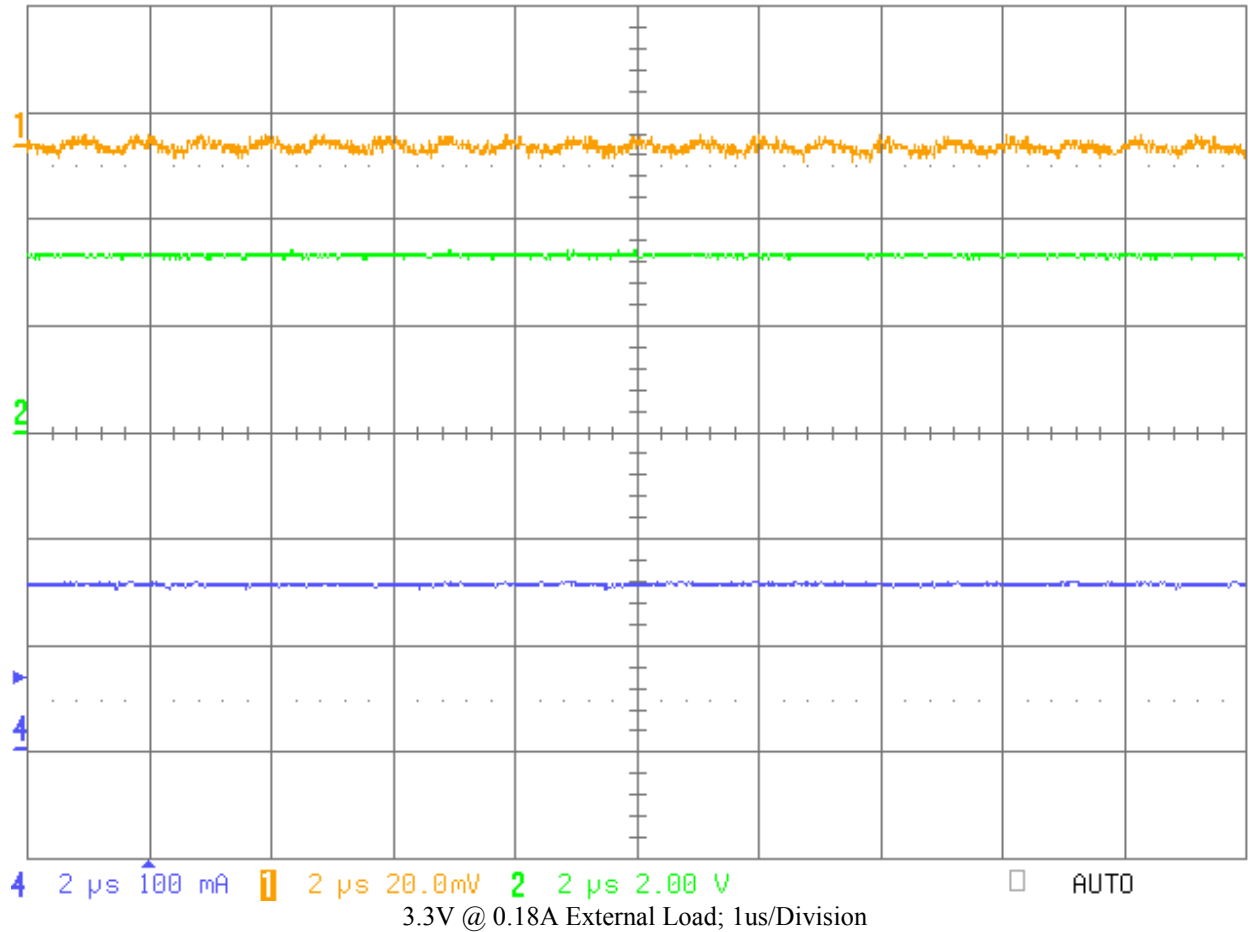

## 2 Load Transients – 3.3V @ 0.18A (TPS62110)

The photo below shows the transient response. The current is pulsed from 0.04A to 0.18A. The input voltage is 12V. The time-base is set to 200us/Division.

Channel 1: 1.2V Output - Orange (20mV/Division; AC Coupled)

Channel 2: 3.3V Output – Green (2V/Division, DC Coupled)

Channel 4: Output Current - Blue (100mA/ Division)

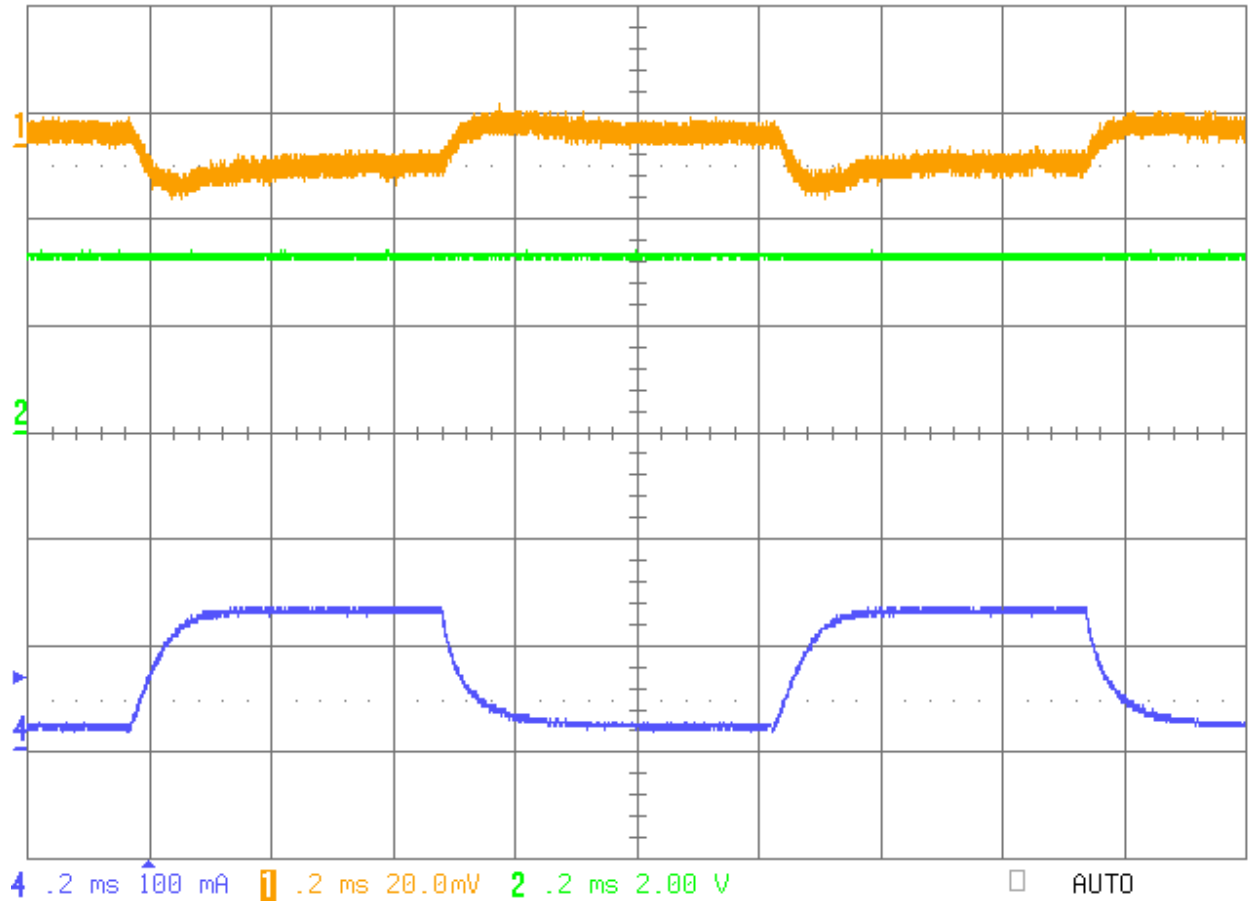

### 3 Load Regulation (TPS62110)

The load regulation is shown in the figure below. The input voltage is 12V.

#### 3.3V@0.18A Output Voltage vs. Load Current

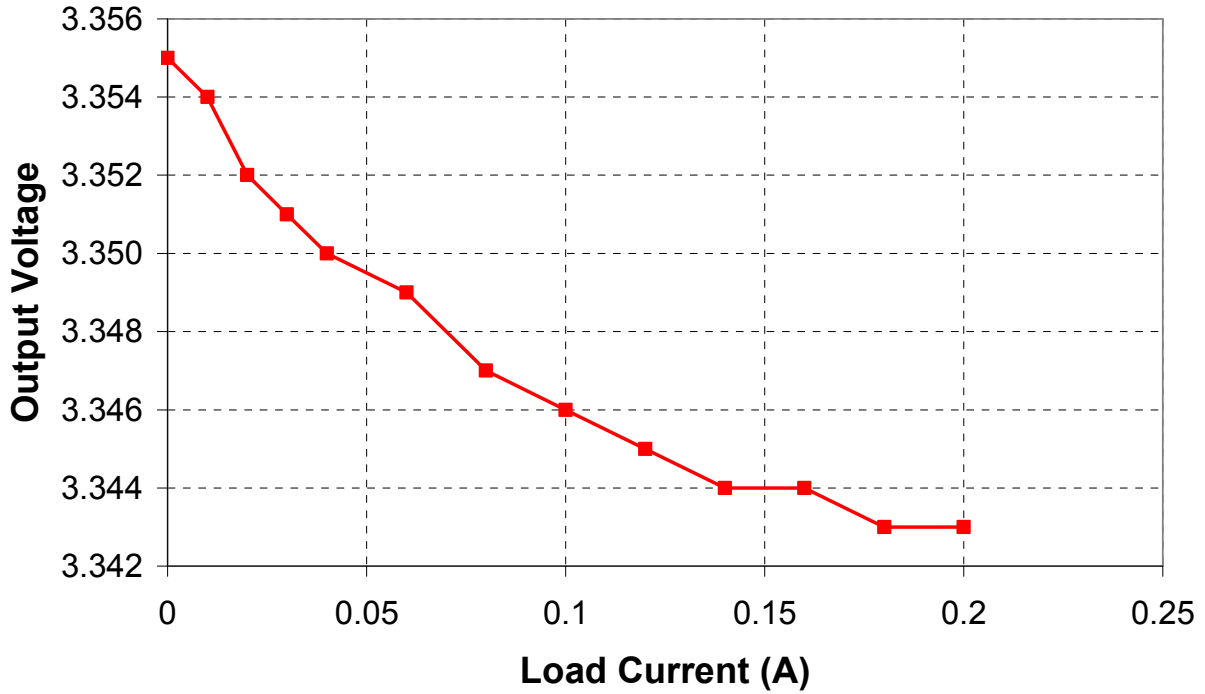

#### 4 Efficiency (TPS62110)

The efficiency is shown in the figure below. The input voltage is 12V.

##### 3.3V@0.18A Efficiency vs. Load Current

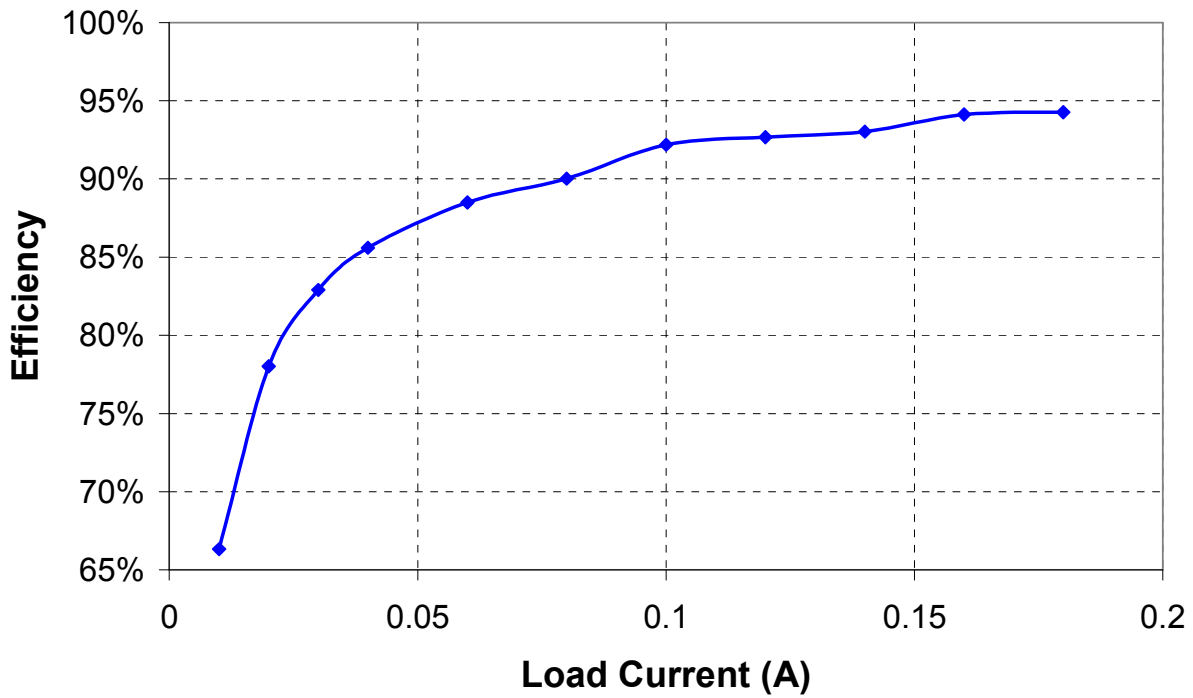

### 5 Switch Node Waveforms 3.3V @ 0.18A (TPS62110)

The plot below shows the switching waveforms for the converter. The input is 12V.

Channel 1: Switch Node - Orange (10V/Division)

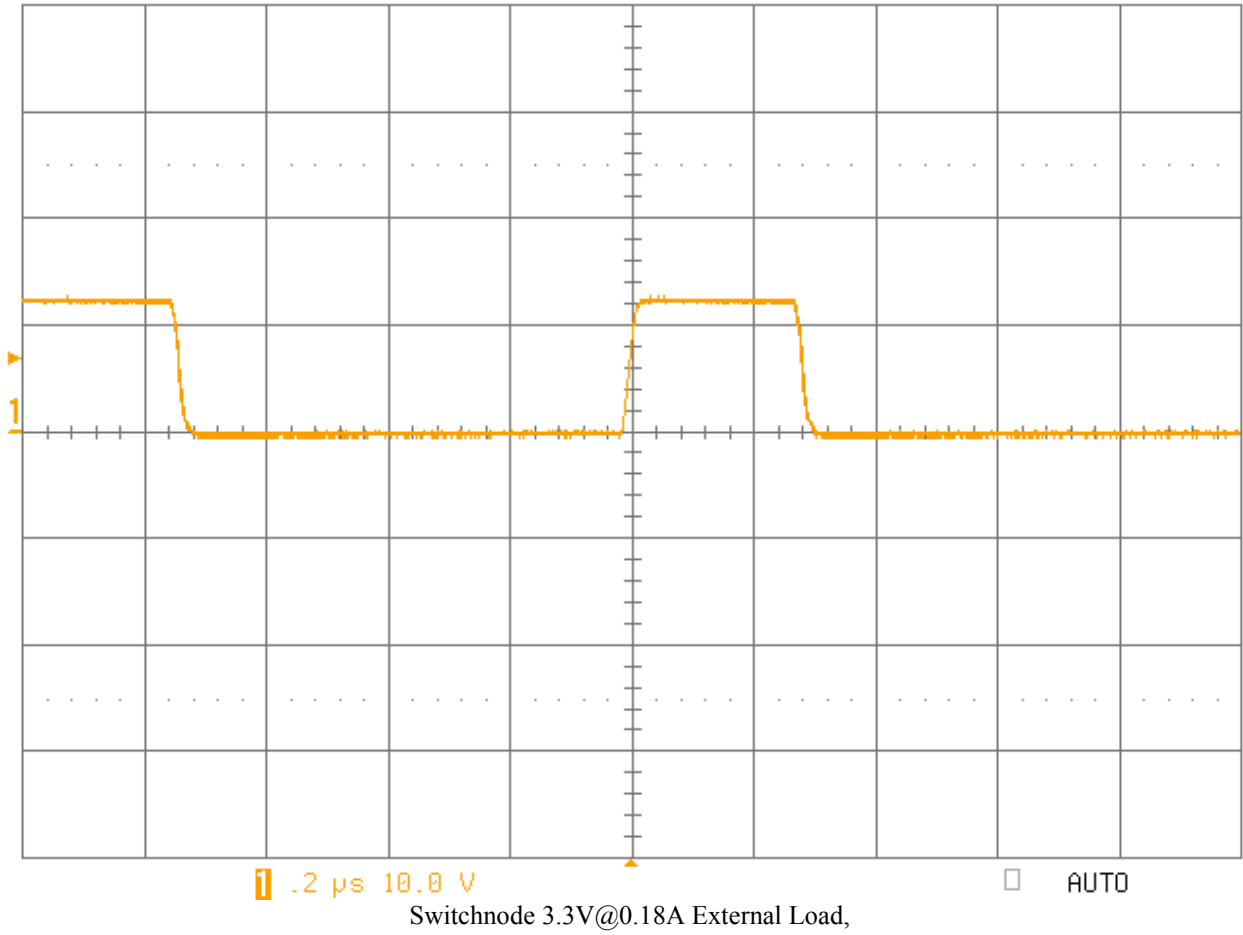



## D. 1.8V @ 0.14A – TPS 73018 – LDO

### 1. Output Ripple Voltage for 1.8V @ 0.14A LDO (TPS73018)

The photo below shows the output voltage ripple. The input voltage is 12V.

Channel 1: 1.8V Output - Orange (20mV/Division; AC Coupled)

Channel 3: 1.8V Output – Red (2V/Division, DC Coupled)

Channel 4: Current Output – Blue (100mA/Division)

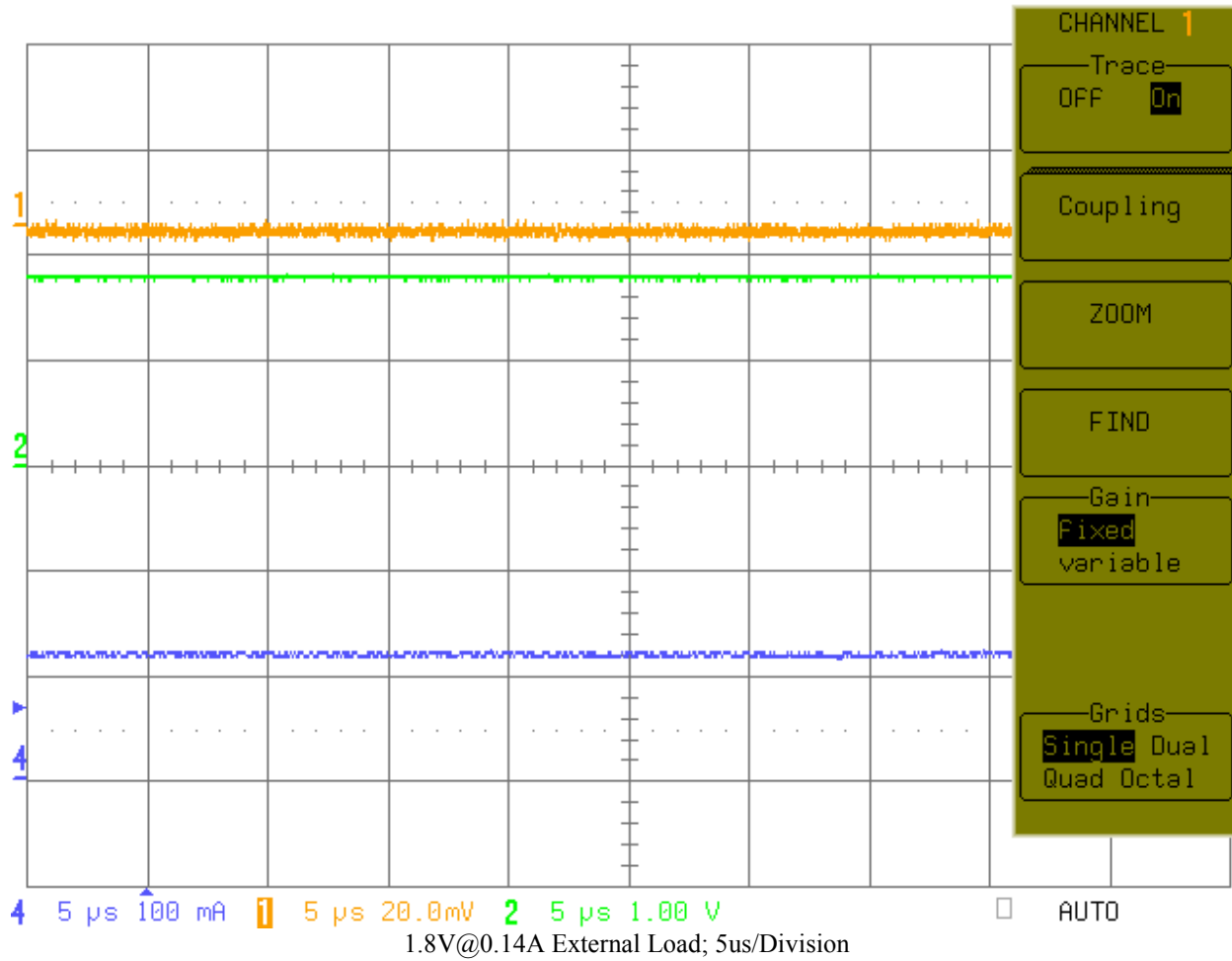

## 2. Load Transients – 1.8V @ 0.14A TPS 73018

### 25% to 100% Load Step

The photo below shows the transient response. The current is pulsed from 0.035A to 0.14A. The input voltage is 12V. The time-base is set to 200us/Division.

Channel 1: 1.8V Output - Orange (20mV/Division; AC Coupled)

Channel 2: 1.8V Output - Green (1V/Division; DC Coupled)

Channel 4: Output Current - Blue (100mA/Division)

